

Varistors (ZNR Surge Absorber)

D type

E-S1 series



Varistors (ZNR Surge Absorber), Series E-S1, improves E series products with high capability for absorbing transient overvoltage in a compact size, suitable for surge protection at high temperature.

Features

- Large withstanding surge current capability in compact sizes
- Withstanding surge current at max. 125 °C
- Large “Energy Handling Capability” absorbing transient overvoltages in compact sizes
- Wide range of varistor voltages
- RoHS compliant

Recommended applications

- Transistor, diode, IC, thyristor or triac semiconductor protection
- Surge protection in consumer electronic equipment
- Surge protection in communication, measuring or controller electronics
- Surge protection in electronic home appliances, gas or petroleum appliances

Applicable standards

- UL1449 (VZCA2/UL, VZCA8/C-UL)
- VDE IEC61051-1, -2, -2-2, IEC60950-1 Annex.Q, IEC62368-1 G8.2
- CQC (GB/T10193, GB/T10194, GB4943.1, GB8898)

Refer to "Standard Products" , and "Application Note for Safety Standards" , for the details.

■ **As for handling precautions and minimum quantity / Packing unit please see related information.**

Explanation of part numbers

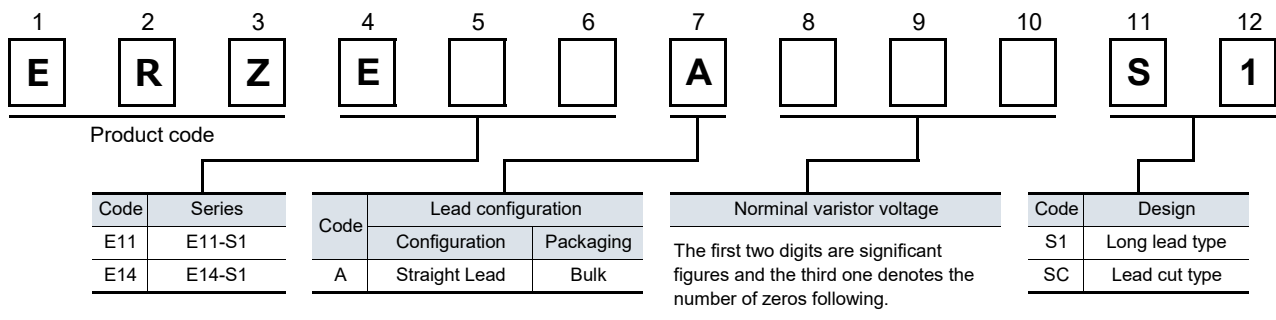

Reference guide to standard products

Part No.	Applicable Standards		Varistor Voltage at 1 mA (V)	Maximum Allowable Voltage		Clamping Voltage at 8/20 μ s		Maximum Peak Current at 8/20 μ s (A)		
	Type name	Approvals		ACrms (V)	DC (V)	max. (V)	Ip (A)	85°C 1 time	125°C 1 time	125°C 2 times
ERZE11A201S1	E11201	○☆★◇◆	200 (185 to 225)	130	170	340	50	6000	5000	4500
ERZE11A221S1	E11221	○☆★◇◆	220 (198 to 242)	140	180	360	50	6000	5000	4500
ERZE11A241S1	E11241	○☆★◇◆	240 (216 to 264)	150	200	395	50	6000	5000	4500
ERZE11A271S1	E11271	○☆★◇◆	270 (247 to 303)	175	225	455	50	6000	5000	4500
ERZE11A331S1	E11331	○☆★◇◆	330 (297 to 363)	210	270	545	50	6000	5000	4500
ERZE11A361S1	E11361	○☆★◇◆	360 (324 to 396)	230	300	595	50	6000	5000	4500
ERZE11A391S1	E11391	○☆★◇◆	390 (351 to 429)	250	320	650	50	6000	5000	4500
ERZE11A431S1	E11431	○☆★◇◆	430 (387 to 473)	275	350	710	50	6000	5000	4500
ERZE11A471S1	E11471	○☆★◇◆	470 (423 to 517)	300	385	775	50	6000	5000	4500
ERZE11A511S1	E11511	○☆★◇◆	510 (459 to 561)	320	410	845	50	6000	5000	4500
ERZE11A561S1	E11561	○☆★◇◆	560 (504 to 616)	350	450	930	50	6000	5000	4500
ERZE11A621S1	E11621	○☆★◇◆	620 (558 to 682)	385	505	1025	50	5000	5000	4500
ERZE11A681S1	E11681	○☆★◇◆	680 (612 to 748)	420	560	1120	50	5000	5000	4500
ERZE11A751S1	E11751	○☆★◇◆	750 (675 to 825)	460	615	1240	50	5000	5000	4500
ERZE11A821S1	E11821	○☆★◇◆	820 (738 to 902)	510	670	1355	50	5000	5000	4500
ERZE11A911S1	E11911	○☆★◇◆	910 (819 to 1001)	550	745	1500	50	5000	5000	4500
ERZE11A102S1	E11102	○☆★◇◆	1000 (900 to 1100)	625	825	1650	50	5000	5000	4500
ERZE11A112S1	E11112	○☆★◇◆	1100 (990 to 1210)	680	895	1815	50	5000	5000	4500

Maximum Allowable Voltage and Maximum Peak Current at 8/20 μ s(A) at 125 °C

○ : UL1449 (VZCA2/UL, VZC A8/C-UL), ☆ : VDE (IEC61051-1, -2, -2-2), ★ : VDE (IEC60950-1 Annex.Q, IEC62368-1 G8.2),

◇ : CQC (GB/T10193, GB/T10194), ◆ : CQC (GB4943.1, GB8898)

※Approval number (File No.) of safety regulations are subject to revision without notice. Ask factory for a copy of the latest file No.

Ratings and characteristics

● Operating temperature range : -40 to 125 °C

● Storage temperature range : -40 to 125 °C

Part No.	Varistor Voltage at 1 mA	Maximum allowable voltage		Clamping voltage (max.) *Ip	Rated power	Maximum energy		Maximum peak current at 8/20 μ s			Capacitance (max.) at 1 kHz
		ACrms (V)	DC (V)			10/1000 μ s	2 ms	85 °C 1 time	125 °C 1 time	125 °C 2 times	
	(V)	(V)	(V)	(W)	(J)	(J)	(A)	(A)	(A)	(pF)	
ERZE11A201S1	200(185 to 225)	130	170	340	0.6	70	50	6000	5000	4500	690
ERZE11A221S1	220(198 to 242)	140	180	360	0.6	78	55	6000	5000	4500	660
ERZE11A241S1	240(216 to 264)	150	200	395	0.6	84	60	6000	5000	4500	620
ERZE11A271S1	270(247 to 303)	175	225	455	0.6	99	70	6000	5000	4500	580
ERZE11A331S1	330(297 to 363)	210	270	545	0.6	115	80	6000	5000	4500	520
ERZE11A361S1	360(324 to 396)	230	300	595	0.6	130	90	6000	5000	4500	480
ERZE11A391S1	390(351 to 429)	250	320	650	0.6	140	100	6000	5000	4500	450
ERZE11A431S1	430(387 to 473)	275	350	710	0.6	155	110	6000	5000	4500	400
ERZE11A471S1	470(423 to 517)	300	385	775	0.6	175	125	6000	5000	4500	360
ERZE11A511S1	510(459 to 561)	320	410	845	0.6	190	136	6000	5000	4500	310
ERZE11A561S1	560(504 to 616)	350	450	930	0.6	190	136	6000	5000	4500	310
ERZE11A621S1	620(558 to 682)	385	505	1025	0.6	190	136	5000	5000	4500	300
ERZE11A681S1	680(612 to 748)	420	560	1120	0.6	190	136	5000	5000	4500	290
ERZE11A751S1	750(675 to 825)	460	615	1240	0.6	210	150	5000	5000	4500	280
ERZE11A821S1	820(738 to 902)	510	670	1355	0.6	235	165	5000	5000	4500	260
ERZE11A911S1	910(819 to 1001)	550	745	1500	0.6	255	180	5000	5000	4500	240
ERZE11A102S1	1000(900 to 1100)	625	825	1650	0.6	280	200	5000	5000	4500	220
ERZE11A112S1	1100(990 to 1210)	680	895	1815	0.6	310	220	5000	5000	4500	200

*Ip Measuring current of clamping voltage : 50 A

Dimensions in mm (not to scale)

Unit : mm

Part No.	D max.	T max.	F \pm 1.0	A max.	L \pm 1.0
ERZE11A201S1	13.0	5.2	7.5	17.0	1.9
ERZE11A221S1	13.0	5.3	7.5	17.0	2.0
ERZE11A241S1	13.0	5.4	7.5	17.0	2.1
ERZE11A271S1	13.0	5.6	7.5	17.0	2.3
ERZE11A331S1	13.0	5.9	7.5	17.0	2.6
ERZE11A361S1	13.0	6.1	7.5	17.0	2.8
ERZE11A391S1	13.0	6.2	7.5	17.0	2.9
ERZE11A431S1	13.0	6.4	7.5	17.0	3.1
ERZE11A471S1	13.0	6.6	7.5	17.0	3.3
ERZE11A511S1	13.0	6.8	7.5	17.0	3.5
ERZE11A561S1	13.0	7.2	7.5	17.0	3.8
ERZE11A621S1	14.0	7.5	7.5	18.0	4.2
ERZE11A681S1	14.0	7.8	7.5	18.0	4.5
ERZE11A751S1	14.0	8.2	7.5	18.0	4.9
ERZE11A821S1	14.0	8.5	7.5	18.0	5.2
ERZE11A911S1	14.0	9.0	7.5	18.0	5.7
ERZE11A102S1	14.0	9.5	7.5	18.0	6.2
ERZE11A112S1	14.0	10.1	7.5	18.0	6.8

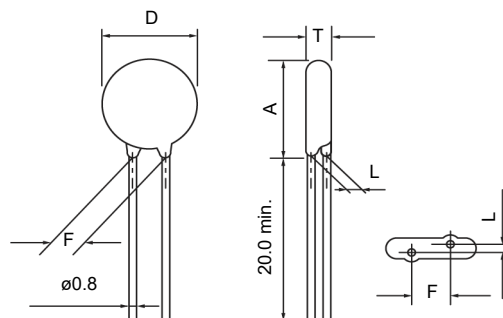

Typical characteristics

Voltage vs. Current

ERZE11A201S1 to ERZE11A511S1

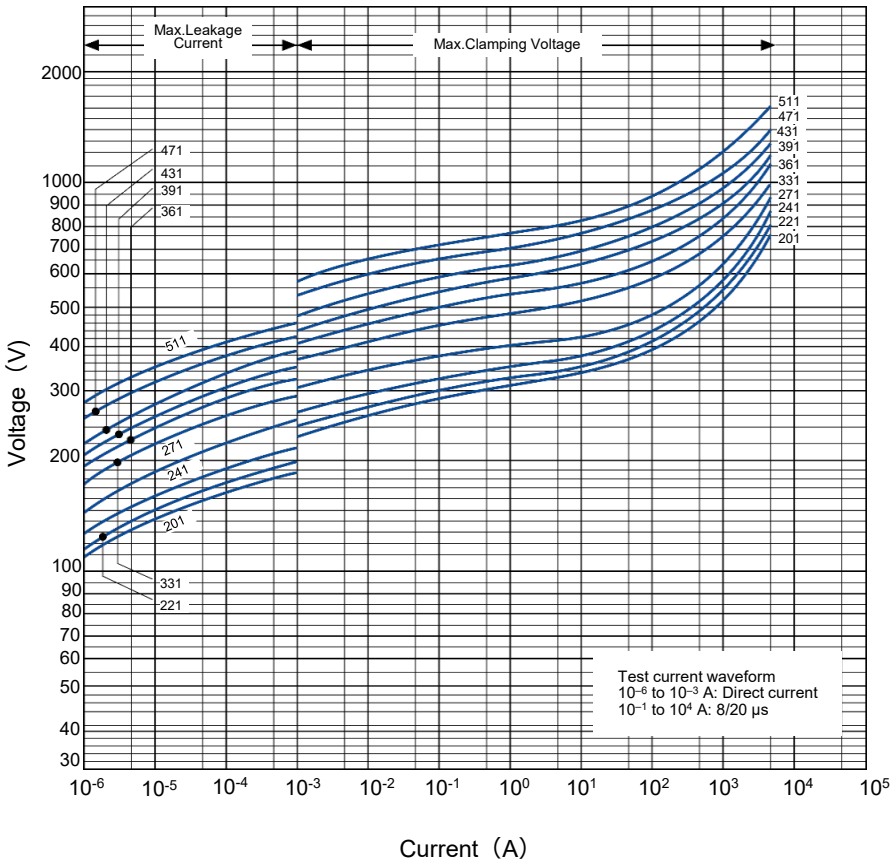

Impulse Derating (Relation between impulse width and impulse current multiple)

ERZE11A201S1 to ERZE11A511S1

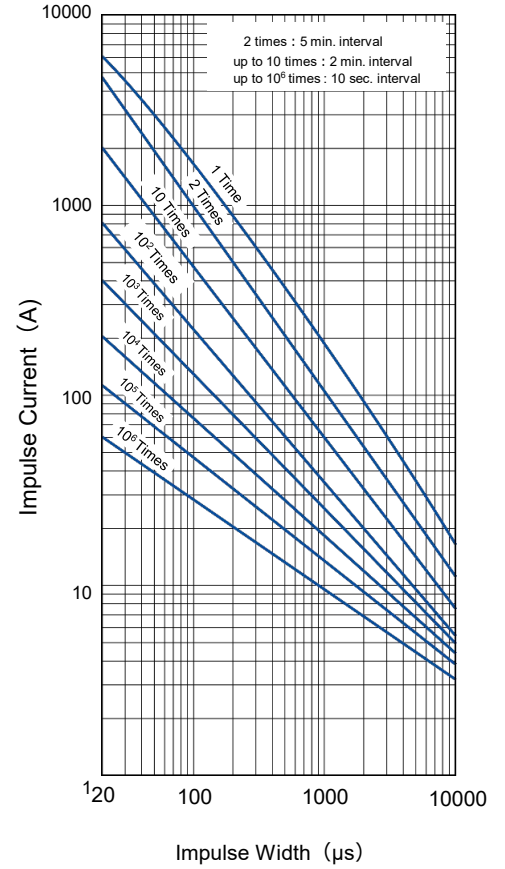

ERZE11A561S1 to ERZE11A112S1

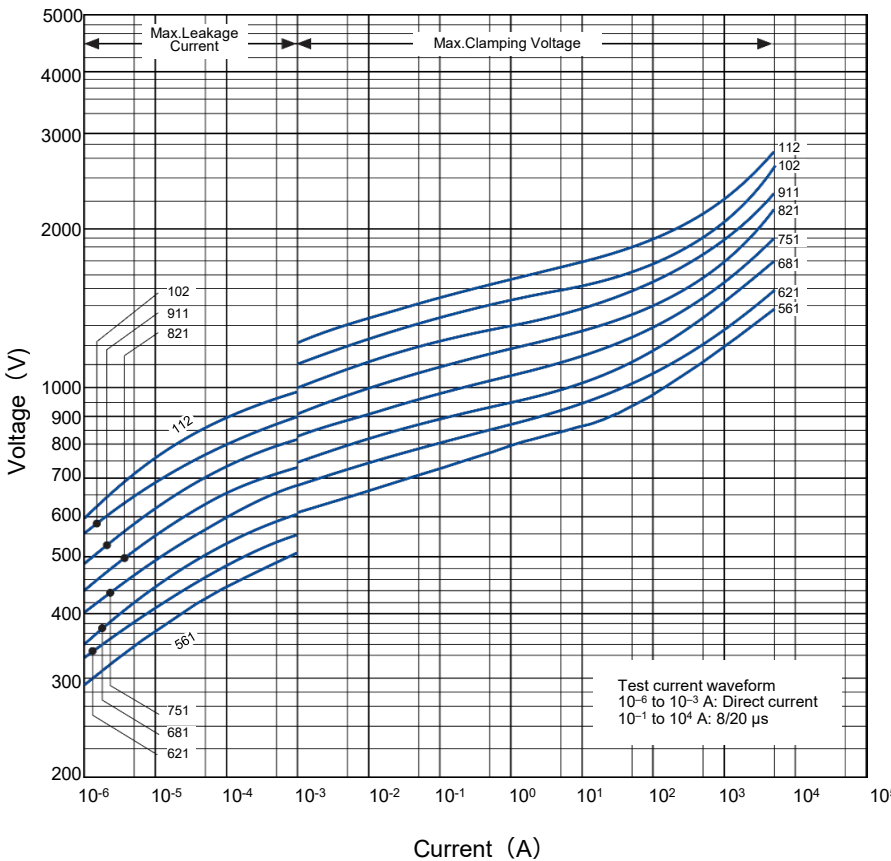

ERZE11A561S1 to ERZE11A112S1

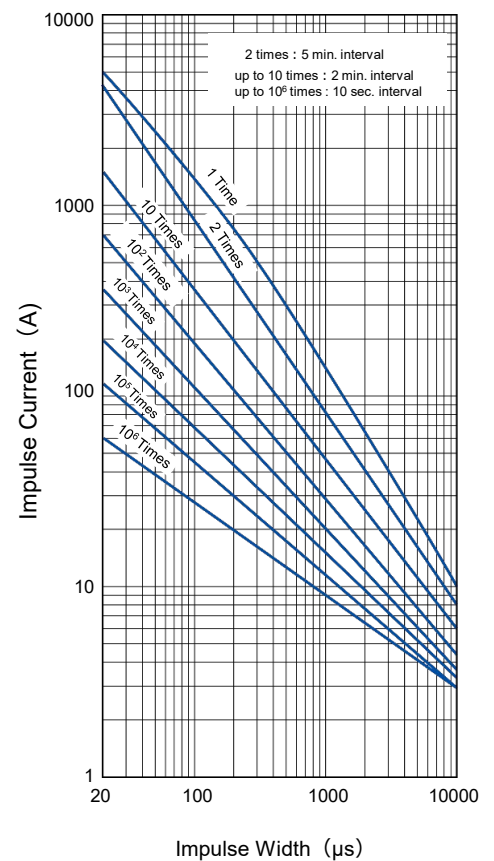

Reference guide to standard products

Part No.	Applicable standards		Varistor voltage at 1 mA (V)	Maximum allowable voltage		Clamping voltage at 8/20 μ s		Maximum peak current at 8/20 μ s (A)		
	Type name	Approvals		ACrms (V)	DC (V)	max. (V)	Ip (A)	85°C 1 time	125°C 1 time	125°C 2 times
ERZE14A201S1	E14201	○☆★◇◆	200 (185 to 225)	130	170	340	100	10000	7500	6500
ERZE14A221S1	E14221	○☆★◇◆	220 (198 to 242)	140	180	360	100	10000	7500	6500
ERZE14A241S1	E14241	○☆★◇◆	240 (216 to 264)	150	200	395	100	10000	7500	6500
ERZE14A271S1	E14271	○☆★◇◆	270 (247 to 303)	175	225	455	100	10000	7500	6500
ERZE14A331S1	E14331	○☆★◇◆	330 (297 to 363)	210	270	545	100	10000	7500	6500
ERZE14A361S1	E14361	○☆★◇◆	360 (324 to 396)	230	300	595	100	10000	7500	6500
ERZE14A391S1	E14391	○☆★◇◆	390 (351 to 429)	250	320	650	100	10000	7500	6500
ERZE14A431S1	E14431	○☆★◇◆	430 (387 to 473)	275	350	710	100	10000	7500	6500
ERZE14A471S1	E14471	○☆★◇◆	470 (423 to 517)	300	385	775	100	10000	7500	6500
ERZE14A511S1	E14511	○☆★◇◆	510 (459 to 561)	320	410	845	100	10000	7500	6500
ERZE14A561S1	E14561	○☆★◇◆	560 (504 to 616)	350	450	930	100	10000	7500	6500
ERZE14A621S1	E14621	○☆★◇◆	620 (558 to 682)	385	505	1025	100	7500	7500	6500
ERZE14A681S1	E14681	○☆★◇◆	680 (612 to 748)	420	560	1120	100	7500	7500	6500
ERZE14A751S1	E14751	○☆★◇◆	750 (675 to 825)	460	615	1240	100	7500	7500	6500
ERZE14A821S1	E14821	○☆★◇◆	820 (738 to 902)	510	670	1355	100	7500	7500	6500
ERZE14A911S1	E14911	○☆★◇◆	910 (819 to 1001)	550	745	1500	100	7500	7500	6500
ERZE14A102S1	E14102	○☆★◇◆	1000 (900 to 1100)	625	825	1650	100	7500	7500	6500
ERZE14A112S1	E14112	○☆★◇◆	1100 (990 to 1210)	680	895	1815	100	7500	7500	6500

Maximum Allowable Voltage and Maximum Peak Current at 8/20 μ s(A) at 125 °C

○ : UL1449 (VZCA2/UL, VZC A8/C-UL), ☆ : VDE (IEC61051-1, -2, -2-2), ★ : VDE (IEC60950-1 Annex.Q, IEC62368-1 G8.2),

◇ : CQC (GB/T10193, GB/T10194), ◆ : CQC (GB4943.1, GB8898)

※Approval number (File No.) of safety regulations are subject to revision without notice. Ask factory for a copy of the latest file No.

Ratings and characteristics

● Operating temperature range : -40 to 125 °C

● Storage temperature range : -40 to 125 °C

Part No.	Varistor voltage at 1 mA	Maximum allowable voltage		Clamping voltage (max.) *I _p	Rated power	Maximum energy		Maximum peak current at 8/20 μs			Capacitance (max.) at 1 kHz
		ACrms (V)	DC (V)			10/1000 μs	2 ms	85 °C 1 time	125 °C 1 time	125 °C 2 times	
	(V)	(V)	(V)	(W)	(J)	(J)	(A)	(A)	(A)	(pF)	
ERZE14A201S1	200(185 to 225)	130	170	340	1.0	140	100	10000	7500	6500	1300
ERZE14A221S1	220(198 to 242)	140	180	360	1.0	155	110	10000	7500	6500	1200
ERZE14A241S1	240(216 to 264)	150	200	395	1.0	168	120	10000	7500	6500	1100
ERZE14A271S1	270(247 to 303)	175	225	455	1.0	190	135	10000	7500	6500	1000
ERZE14A331S1	330(297 to 363)	210	270	545	1.0	228	160	10000	7500	6500	900
ERZE14A361S1	360(324 to 396)	230	300	595	1.0	255	180	10000	7500	6500	900
ERZE14A391S1	390(351 to 429)	250	320	650	1.0	275	195	10000	7500	6500	800
ERZE14A431S1	430(387 to 473)	275	350	710	1.0	303	215	10000	7500	6500	800
ERZE14A471S1	470(423 to 517)	300	385	775	1.0	350	250	10000	7500	6500	750
ERZE14A511S1	510(459 to 561)	320	410	845	1.0	382	273	10000	7500	6500	700
ERZE14A561S1	560(504 to 616)	350	450	930	1.0	382	273	10000	7500	6500	700
ERZE14A621S1	620(558 to 682)	385	505	1025	1.0	382	273	7500	7500	6500	650
ERZE14A681S1	680(612 to 748)	420	560	1120	1.0	382	273	7500	7500	6500	600
ERZE14A751S1	750(675 to 825)	460	615	1240	1.0	420	300	7500	7500	6500	530
ERZE14A821S1	820(738 to 902)	510	670	1355	1.0	460	325	7500	7500	6500	500
ERZE14A911S1	910(819 to 1001)	550	745	1500	1.0	510	360	7500	7500	6500	400
ERZE14A102S1	1000(900 to 1100)	625	825	1650	1.0	565	400	7500	7500	6500	400
ERZE14A112S1	1100(990 to 1210)	680	895	1815	1.0	620	440	7500	7500	6500	350

*I_p Measuring current of clamping voltage : 100 A

Dimensions in mm (not to scale)

Unit : mm

Part No.	D max.	T max.	F±1.0	A max.	L±1.0
ERZE14A201S1	16.5	5.2	10.0	20.0	2.1
ERZE14A221S1	16.5	5.3	10.0	20.0	2.2
ERZE14A241S1	16.5	5.4	10.0	20.0	2.3
ERZE14A271S1	16.5	5.6	10.0	20.0	2.5
ERZE14A331S1	16.5	5.9	10.0	20.0	2.8
ERZE14A361S1	16.5	6.1	10.0	20.0	3.0
ERZE14A391S1	16.5	6.2	10.0	20.0	3.1
ERZE14A431S1	16.5	6.4	10.0	20.0	3.3
ERZE14A471S1	16.5	6.6	10.0	20.0	3.5
ERZE14A511S1	16.5	6.8	10.0	20.0	3.7
ERZE14A561S1	16.5	7.2	10.0	20.0	4.0
ERZE14A621S1	17.5	7.5	10.0	20.5	4.4
ERZE14A681S1	17.5	7.8	10.0	20.5	4.7
ERZE14A751S1	17.5	8.2	10.0	20.5	5.1
ERZE14A821S1	17.5	8.5	10.0	20.5	5.4
ERZE14A911S1	17.5	9.0	10.0	20.5	5.9
ERZE14A102S1	17.5	9.5	10.0	20.5	6.4
ERZE14A112S1	17.5	10.1	10.0	20.5	7.2

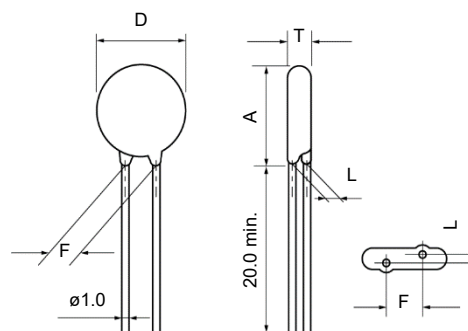

Typical characteristics

Voltage vs. Current

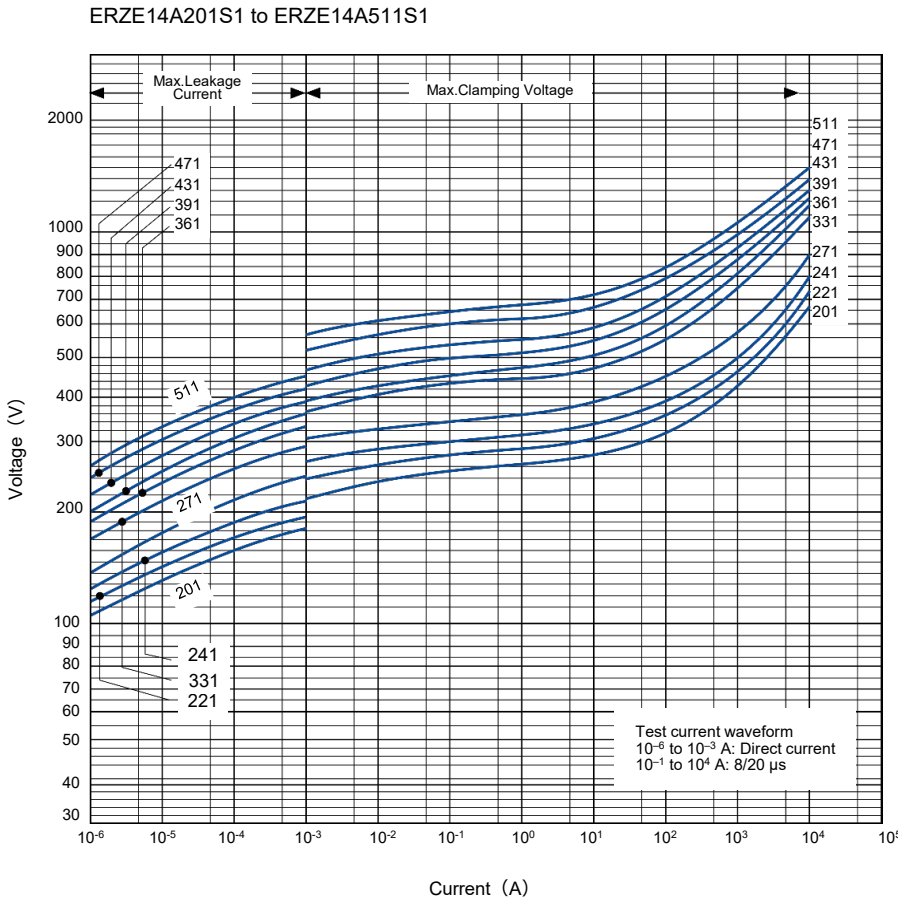

Impulse Derating (Relation between impulse width and impulse current multiple)

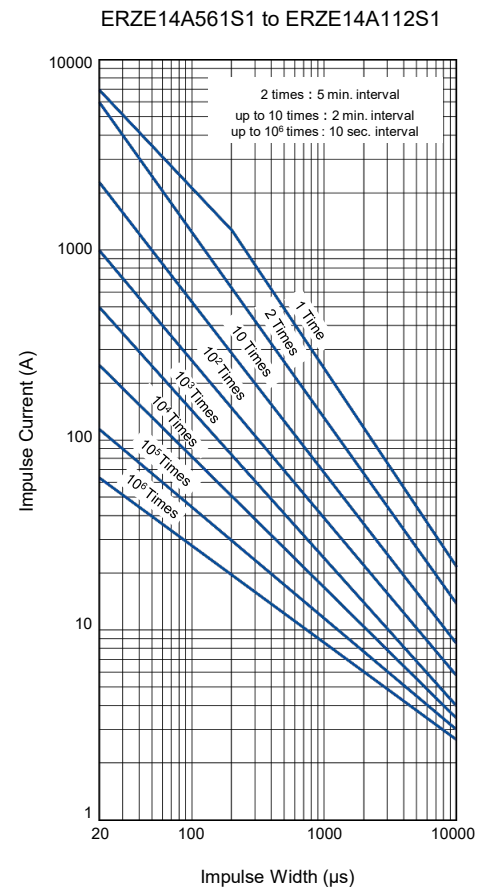
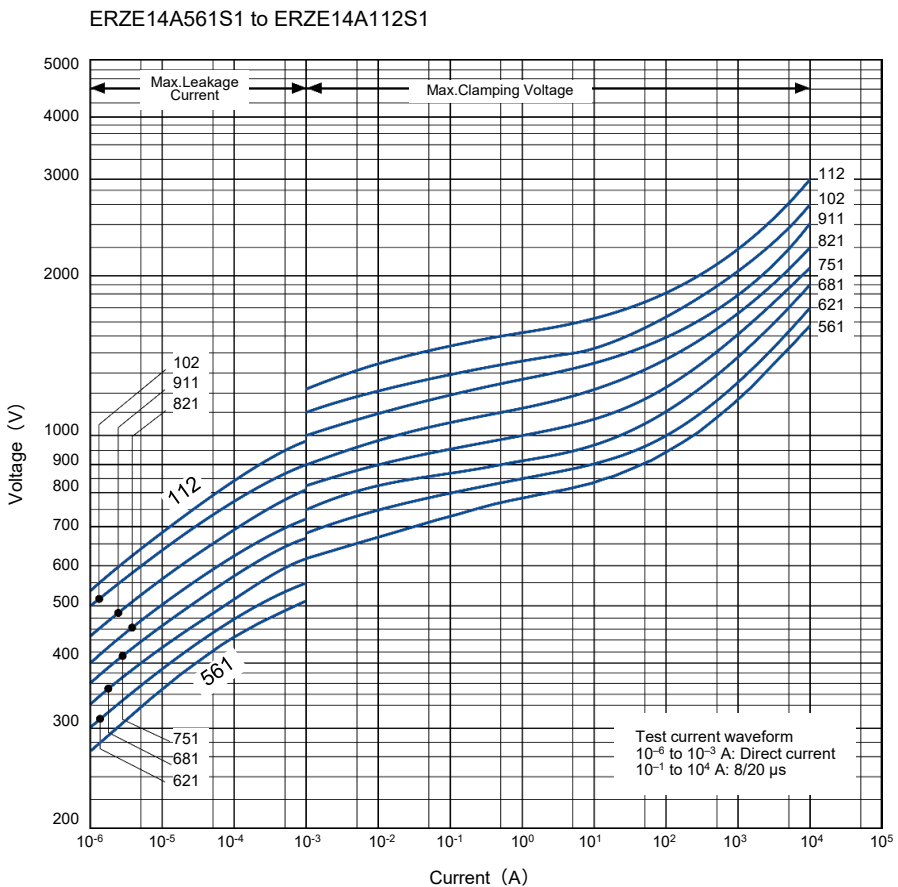
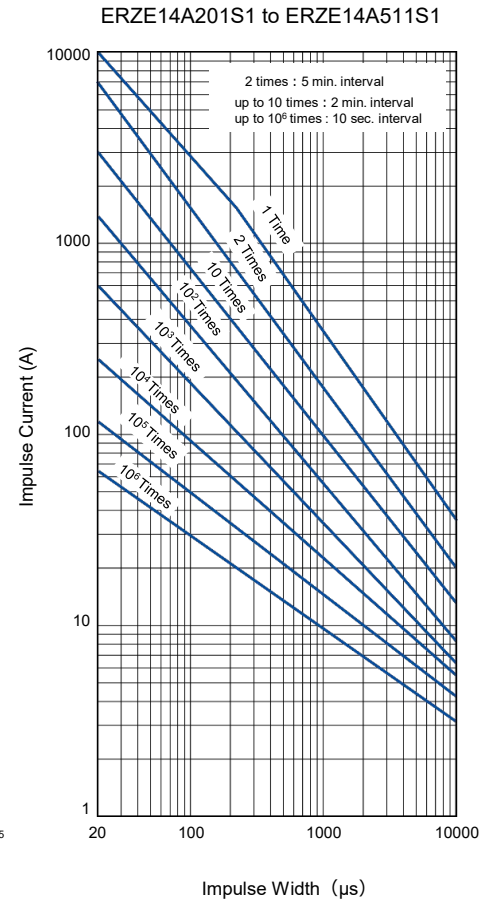

Straight leads cut type (Bulk type)

※ Ratings and characteristics is refer to bulk standard type.

Dimensions in mm (not to scale)

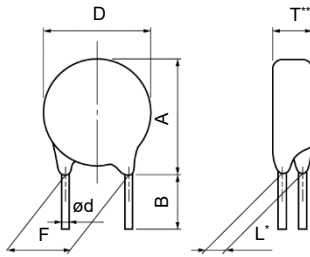

notes * Dimension "L": Conforms to each individual specification.

** Dimension "T": Conforms to each individual specification.

Unit : mm

Series Symbol	Varister Voltage	E11-S1		E14-S1	
		201 to 561	621 to 112	201 to 561	621 to 112
D		13.0 max	14.0 max	16.5 max	17.5 max
A		17.0 max	18.0 max	20.0 max	20.5 max
F		7.5±1.0	7.5±1.0	10.0±1.0	10.0±1.0
ø d		0.80 ^{+0.08} _{-0.05}	0.80 ^{+0.08} _{-0.05}	1.00 ^{+0.1} _{-0.05}	1.00 ^{+0.1} _{-0.05}
B		4.0±1.0	4.0±1.0	4.0±1.0	4.0±1.0
Standard Products Part No.		ERZE11A□□□SC		ERZE14A□□□SC	

Application Note for Safety Standards (For Series E-S1)

- Approvals products lists in "Reference Guide to Standard Products."
- UL and VDE : Registered in "Type name", it isn't registered in "Panasonic Part No."
- CQC : Registered in "Panasonic Part No."
- "Rated Voltages" are specified for UL recognized components in list shown below.

The AC rated voltage and maximum allowable voltage

Type name	Maximum Allowable Voltage		Rated Voltage (Vrms)
	ACrms (V)	DC (V)	UL1449
E*201	130	170	118
E*221	140	180	127
E*241	150	200	136
E*271	175	225	159
E*331	210	270	189
E*361	230	300	209
E*391	250	320	227
E*431	275	350	250
E*471	300	385	272
E*511	320	410	291
E*561	350	450	320
E*621	385	505	350
E*681	420	560	381
E*751	460	615	418
E*821	510	670	463
E*911	550	745	500
E*102	625	825	568
E*112	680	895	600

* : 11 series is 11, 14 series is 14

Explanation of the contents

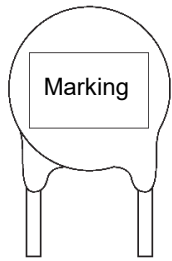

Mark	Explanation of the content	
E11□□□ E14□□□	Abbreviation of Part No. (Type name)	[□□□ Nominal varistor volage]
○	Factory identification mark	None:Japan Q:Indonesia
◆*1	Year code	2019 : 9, 2020 : K, 2021 : A 2022 : B, 2023 : C, 2024 : D
◇	Monthly code	Jan : 1 to Sep : 9, Oct. : 0, Nov. : N, Dec. : D
H	Identification Code	
	UL Recognized Components Mark	

*1: If the 10's digit of a Christian year is an even year, as an end abbreviation, an alphabetic character is used.

1 : A, 2 : B, 3 : C, 4 : D, 5 : E, 6 : F, 7 : G, 8 : H, 9 : J, 0 : K

If the 10's digit of a Christian year is an odd year, as an end abbreviation, a number is used.

Marking contents

Series (Example)	11 (ERZE11A□□□S1)	14 (ERZE14A□□□S1)
Varister voltage		
201 or more	ZNR E11□□□ ○ ◆ ◇ H	ZNR E14□□□ ○ ◆ ◇ H

Performance characteristics

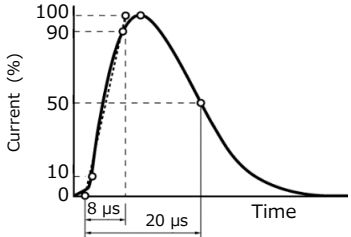
Characteristics		Test methods / description	Specifications														
Standard test condition		Electrical measurements (initial/after tests) shall be conducted at temperature of 5 to 35 °C, relative humidity of maximum 85 %.	—														
Electrical	Varistor voltage	The voltage between two terminals with the specified measuring current 1mA DC applied is called V_1 or V_{1mA} . The measurement shall be made as fast as possible to avoid heat affection.	To meet the specified value.														
	Maximum allowable voltage	The maximum sinusoidal RMS voltage or maximum DC voltage that can be applied continuously. (max. 125 °C)															
	Clamping voltage	The maximum voltage between two terminals with the specified standard impulse current (8/20 μ s) illustrated below applied. 															
	Rated power	The power that can be applied in the specified ambient temperature.															
	Maximum energy	The maximum energy within the varistor voltage change of ± 10 % when a single impulse current of 2 ms or 10/1000 μ s is applied.															
	Maximum peak current (Withstanding surge current)	2 times		The maximum current within the varistor voltage change of ± 10 % when a standard impulse current of 8/20 μ s is applied two times with an interval of 5 minutes. (at max. 125 °C)													
		1 time		The maximum current within the varistor voltage change of ± 10 % with a single standard impulse current of 8/20 μ s is applied. (at max. 125 °C)													
	Temperature coefficient of varistor voltage	$\frac{V_{1mA} \text{ at } 125\text{ }^\circ\text{C} - V_{1mA} \text{ at } 25\text{ }^\circ\text{C}}{V_{1mA} \text{ at } 25\text{ }^\circ\text{C}} \times \frac{1}{100} 100(\%/^\circ\text{C})$		0 to -0.05 %/ °C max.													
	Capacitance	Capacitance shall be measured at 1 kHz ± 10 %, 1 Vrms max. (1 MHz ± 10 % below 100 pF), 0 V bias and 20 \pm 2 °C.		To meet the specified value.													
	Withstanding voltage (Body Insulation)	AC 1500 Vrms shall be applied between both terminals of the specimen connected together and metal foil closely wrapped round its body for 1 minute.		No breakdown													
Impulse life	The change of VC shall be measured after the impulse current listed below is applied 10000 or 100000 times continuously with the interval of 10 seconds at room temperature. <table border="1" data-bbox="406 1697 1184 1921"> <thead> <tr> <th>Item</th> <th>Impulse Life(I)</th> <th>Impulse Life(II)</th> </tr> </thead> <tbody> <tr> <td>Times</td> <td>$\times 10^4$ Times</td> <td>$\times 10^5$ Times</td> </tr> <tr> <th>Part No.</th> <th colspan="2">Impulse Current</th> </tr> <tr> <td>ERZE11A201S1 to ERZE11A112S1</td> <td>200 A (8/20 μs)</td> <td>110 A (8/20 μs)</td> </tr> <tr> <td>ERZE14A201S1 to ERZE14A112S1</td> <td>250 A (8/20 μs)</td> <td>120 A (8/20 μs)</td> </tr> </tbody> </table>	Item	Impulse Life(I)	Impulse Life(II)	Times	$\times 10^4$ Times	$\times 10^5$ Times	Part No.	Impulse Current		ERZE11A201S1 to ERZE11A112S1	200 A (8/20 μ s)	110 A (8/20 μ s)	ERZE14A201S1 to ERZE14A112S1	250 A (8/20 μ s)	120 A (8/20 μ s)	$\Delta V_{1mA} / V_{1mA} \leq 0 \text{ to } +20\%$
Item	Impulse Life(I)	Impulse Life(II)															
Times	$\times 10^4$ Times	$\times 10^5$ Times															
Part No.	Impulse Current																
ERZE11A201S1 to ERZE11A112S1	200 A (8/20 μ s)	110 A (8/20 μ s)															
ERZE14A201S1 to ERZE14A112S1	250 A (8/20 μ s)	120 A (8/20 μ s)															

Performance characteristics

Characteristics		Test methods / description		Specifications														
Mechanical	Robustness of terminations (Tensile)	After gradually applying the force specified below and keeping the unit fixed for 10 seconds, the terminal shall be visually examined for any damage.		No remarkable mechanical damage														
		<u>Terminal diameter</u>	<u>Force</u>															
		ø0.6 mm, ø0.8 mm	9.8 N															
		ø1.0 mm	19.6 N															
	Robustness of terminations (Bending)	The unit shall be secured with its terminal kept vertical and the force specified below shall be applied in the axial direction. The terminal shall gradually be bent by 90 ° in one direction, then 90 ° in the opposite direction, and again back to the original position. The damage of the terminal shall be visually examined.																
	<u>Terminal diameter</u>	<u>Force</u>																
	ø0.6 mm, ø0.8 mm	4.9 N																
	ø1.0 mm	9.8 N																
Vibration	After repeatedly applying a single harmonic vibration (amplitude: 0.75 mm, double amplitude: 1.5 mm) with 1 minute vibration frequency cycles (10 Hz to 55 Hz to 10 Hz) to each of three perpendicular directions for 2 hours. Thereafter, the unit shall be visually examined.																	
Solderability	After dipping the terminals to a depth of approximately 3 mm from the body in a soldering bath of 235±5 °C for 2±0.5 seconds, the terminal shall be visually examined.		Approximately 95 % of the terminals shall be covered with new solder uniformly.															
Resistance to soldering heat	After each lead shall be dipped into a solder bath having a temperature of 260±5 °C to a point 2.0 to 2.5 mm from the body of the unit, using shielding board (t=1.5 mm), be held there for 10±1 s and then be stored at room temperature and normal humidity for 1 to 2 hours. The change of VCmA and mechanical damages shall be examined.		$\Delta V_{1\text{ mA}}/V_{1\text{ mA}} \leq \pm 5\%$															
Environmental	High temperature storage/Dry heat	The specimen shall be subjected to 125±2 °C for 1000 hours in a thermostatic bath without load and then stored at room temperature and normal humidity for 1 to 2 hours. Thereafter, the change of VCmA shall be measured.		$\Delta V_{1\text{ mA}}/V_{1\text{ mA}} \leq \pm 5\%$														
	Humidity	The specimen shall be subjected to 40±2 °C, 90 to 95 % RH for 1000 hours without load and then stored at room temperature and normal humidity for 1 to 2 hours. Thereafter, the change of VCmA shall be measured.		$\Delta V_{1\text{ mA}}/V_{1\text{ mA}} \leq \pm 5\%$														
	Temperature cycle	The temperature cycle shown below shall be repeated five cycles and then stored at room temperature and normal humidity for 1 to 2 hours. The change of VCmA and mechanical damage shall be examined.		$\Delta V_{1\text{ mA}}/V_{1\text{ mA}} \leq \pm 5\%$ No remarkable mechanical damage														
		<table border="1"> <thead> <tr> <th>Step</th> <th>Temperature (°C)</th> <th>Period (minutes)</th> </tr> </thead> <tbody> <tr> <td>1</td> <td>-40±3</td> <td>30±3</td> </tr> <tr> <td>2</td> <td>Room temperature</td> <td>15±3</td> </tr> <tr> <td>3</td> <td>125±2</td> <td>30±3</td> </tr> <tr> <td>4</td> <td>Room temperature</td> <td>15±3</td> </tr> </tbody> </table>	Step	Temperature (°C)	Period (minutes)	1	-40±3	30±3	2	Room temperature	15±3	3	125±2	30±3	4	Room temperature	15±3	
	Step	Temperature (°C)	Period (minutes)															
	1	-40±3	30±3															
2	Room temperature	15±3																
3	125±2	30±3																
4	Room temperature	15±3																
High temperature load/Dry heat load	After being continuously applied the Maximum Allowable Voltage at 125±2 °C for 1000 hours, the specimen shall be stored at room temperature and normal humidity for 1 to 2 hours. Thereafter, the change of VCmA shall be measured.		$\Delta V_{1\text{ mA}}/V_{1\text{ mA}} \leq \pm 10\%$															
Damp heat load/humidity load	The specimen shall be subjected to 40±2 °C, 90 to 95 % RH and the Maximum Allowable Voltage for 1000 hours and then stored at room temperature and normal humidity for 1 to 2 hours. Thereafter, the change of VCmA shall be measured.																	
Low temperature storage/Cold	The specimen shall be subjected to -40±2 °C without load for 1000 hours and then stored at room temperature and normal humidity for 1 to 2 hours. Thereafter, the change of VCmA shall be measured.		$\Delta V_{1\text{ mA}}/V_{1\text{ mA}} \leq \pm 5\%$															

Minimum quantity / Packing unit

Product	Series / Type		Part number	Minimum quantity / Packing unit	Packing quantity in carton	Carton (about) L×W×H (mm)
Varistors (ZNR Surge Absorber)	D type E-S1 series	Straight leads <Bulk>	ERZE11A201S1 to 361S1	50	3000	210×340×110
			ERZE11A391S1 to 561S1	50	2000	210×340×110
			ERZE11A621S1 to 112S1	50	1000	210×340×110
			ERZE14A201S1 to 221S1	50	2000	210×340×110
			ERZE14A241S1 to 431S1	50	2000	210×340×110
			ERZE14A471S1 to 112S1	50	1000	210×340×110
		Leads cut type <Bulk>	ERZE11A201SC to 361SC	50	3000	210×340×110
			ERZE11A391SC to 561SC	50	2000	210×340×110
			ERZE11A621SC to 112SC	50	2000	210×340×110
			ERZE14A201SC to 361SC	50	2000	210×340×110
			ERZE14A391SC to 561SC	50	2000	210×340×110
			ERZE14A621SC to 112SC	50	1000	210×340×110

Part No., quantity and country of origin are designated on outer packages in English.

※Please contact local sales office about packing specifications.

Safety and Legal Matters to Be Observed

Product specifications and applications

- Please be advised that this product and product specifications are subject to change without notice for improvement purposes. Therefore, please request and confirm the latest delivery specifications that explain the specifications in detail before the final design, or purchase or use of the product, regardless of the application. In addition, do not use this product in any way that deviates from the contents of the company's delivery specifications.
- Unless otherwise specified in this catalog or the product specifications, this product is intended for use in general electronic equipment (AV products, home appliances, commercial equipment, office equipment, information and communication equipment, etc.).
When this product is used for the following special cases, the specification document suited to each application shall be signed/sealed (with Panasonic Industry and the user) in advance..These include applications requiring special quality and reliability, wherein their failures or malfunctions may directly threaten human life or cause harm to the human body (e.g.: space/aircraft equipment, transportation/traffic equipment, combustion equipment, medical equipment, disaster prevention/crime prevention equipment, safety equipment, etc.).

Safety design and product evaluation

- Please ensure safety through protection circuits, redundant circuits, etc., in the customer's system design so that a defect in our company's product will not endanger human life or cause other serious damage.
- This catalog shows the quality and performance of individual parts. The durability of parts varies depending on the usage environment and conditions. Therefore, please ensure to evaluate and confirm the state of each part after it has been mounted in your product in the actual operating environment before use.
If you have any doubts about the safety of this product, then please notify us immediately, and be sure to conduct a technical review including the above protection circuits and redundant circuits at your company.

Laws / Regulations / Intellectual property

- The transportation of dangerous goods as designated by UN numbers, UN classifications, etc., does not apply to this product. In addition, when exporting products, product specifications, and technical information described in this catalog, please comply with the laws and regulations of the countries to which the products are exported, especially those concerning security export control.
- Each model of this product complies with the RoHS Directive (Restriction of the use of hazardous substances in electrical and electronic equipment) (2011/65/EU and (EU) 2015/863). The date of compliance with the RoHS Directive and REACH Regulation varies depending on the product model.
Further, if you are using product models in stock and are not sure whether or not they comply with the RoHS Directive or REACH Regulation, please contact us by selecting "Sales Inquiry" from the inquiry form.
- During the manufacturing process of this product and any of its components and materials to be used, Panasonic Industry does not intentionally use ozone-depleting substances stipulated in the Montreal Protocol and specific bromine-based flame retardants such as PBBs (Poly-Brominated Biphenyls) / PBDEs (Poly-Brominated Diphenyl Ethers). In addition, the materials used in this product are all listed as existing chemical substances based on the Act on the Regulation of Manufacture and Evaluation of Chemical Substances.
- With regard to the disposal of this product, please confirm the disposal method in each country and region where it is incorporated into your company's product and used.
- The technical information contained in this catalog is intended to show only typical operation and application circuit examples of this product. This catalog does not guarantee that such information does not infringe upon the intellectual property rights of Panasonic Industry or any third party, nor imply that the license of such rights has been granted.
- Design, materials, or process related to technical owned by Panasonic Industry are subject to change without notice.

Panasonic Industry will assume no liability whatsoever if the use of our company's products deviates from the contents of this catalog or does not comply with the precautions. Please be advised of these restrictions.

Matters to Be Observed When Using This Product

(D-type : E series)

Safety measures

An abnormal state of the D-type / E series varistor (ZNR surge absorber, hereinafter "the product" or "the surge absorber") that results from a problem with service conditions (materials used, the surrounding environment, power conditions, circuit conditions, etc.) may cause a fire accident, electric shock accident, burn accident, or product failure. Matters to note when handling this product will hereinafter be described. What is described below should be checked sufficiently before the product is used.

■ Confirming rated capabilities

Use the surge absorber within the range of its rated capabilities. Each type of surge absorber has specified rated capabilities including a maximum allowable circuit voltage, a surge current tolerance, an energy tolerance, an impulse lifespan (surge lifespan), average pulse power, and a service temperature. Using the surge absorber under severe service conditions that are beyond the rated capabilities causes degraded performance of the surge absorber or destruction of a circuit element, which may lead to smoke generation, ignition, etc.

■ Take the following measures in order to avoid an accident caused by expected phenomenon.

- (1) Destruction of the surge absorber may scatter its fractured pieces around. To protect other elements from these pieces, set product in a case or shield it with a cover.
- (2) Do not place the surge absorber near combustible materials (vinyl cable, resin mold, etc.). If avoiding the vicinity of combustible materials is difficult, protect the combustible material with an incombustible cover.
- (3) Surge absorber placed between lines

When the surge absorber is placed between lines, connect a normal type current fuse in series with the surge absorber.

* See "Current fuse" in the "Circuit design and circuit board design" section.

- (4) Surge absorber placed between a line and the ground

- ① When the surge absorber is placed between a line and the ground, even if the surge absorber short-circuits, ground resistance will remain in the section between the line and the ground, leaving a possibility that the current fuse won't blow, in which case the outer sheath resin of the surge absorber may generate smoke or ignite due to current flow. To prevent such a case, place an earth leakage breaker in a location closer to the power supply than the surge absorber. When not using an earth leakage breaker, use a current fuse and temperature fuse in series with each other.

* See Table 1 in the "Circuit design and circuit board design" section.

- ② When the surge absorber is placed between a live part and a metal case, it may cause electric shock if the surge absorber short-circuits. To avoid this, ground the metal case or shield it to prevent direct contact with the metal case.

■ In case the surge absorber should short-circuit and generate smoke or ignite, immediately cut off current flow to the surge absorber.

■ Rated voltage for UL certification, etc.

To allow the surge absorber to meet leak current requirements, etc., a maximum allowable circuit voltage and rated voltage are specified for the surge absorber.

When applying for UL certification, etc. of a device equipped with a surge absorber, ensure the working voltage of the device does not exceed the rated voltage of the surge absorber.

■ An unexpected sharp rise in the working voltage, an incoming excessive surge, etc., may cause the surge absorber to generate smoke or ignite.

In such a case, fire spreading through the device should be prevented to avoid expanded damage. To achieve this, take a multi-protection measure, such as adopting fire-resistant materials that make up the outer shell components and structural materials.

Use environments and cleaning conditions

■ Do not use the surge absorber in an outdoor environment where the surge absorber is exposed to sunlight.

■ Do not use the surge absorber in which direct sunlight hits the surge absorber or near a heating element where the temperature of the surge absorber would rise above its working temperature.

■ Do not use the surge absorber in a place where the surge absorber is exposed to wind or rain or a highly humid place where steam is emitted or dew concentrates.

- Do not use the surge absorber in a place filled with dust or salt, in an atmosphere contaminated with a corrosive gas, etc., or in liquids such as water, oil, chemical, or organic solvents.
- Do not wash the surge absorber with a solvent (thinner, acetone, etc.) that damages the outer sheath resin.

Response to anomalies and handling conditions

Be careful not to drop the surge absorber on the floor, etc. The product is likely to suffer mechanical or electrical damage when dropped on the floor. Avoid using such a product.

Circuit design and circuit board design

Meet the following requirements. Not following the requirements can result in a shorter lifespan of the surge absorber or its failure.

- Choose a surge absorber whose maximum allowable circuit voltage has a margin relative to the maximum voltage range including source voltage fluctuations.
 - * See Table 1 in the "Circuit design and circuit board design" section.
- When surges are applied intermittently to the surge absorber at short intervals (when pulses of voltages are applied in a noise simulator test, etc.), make sure that the surge power does not exceed the maximum average pulse power of the surge absorber.
- The product numbers of recommended surge absorbers to choose are shown in Table 1.

(1) The case of placing the surge absorber between lines

When the source voltage is expected to rise temporarily due to unbalanced single-wire loads in a three-phase three-wire connection configuration, a short circuit between a voltage line and a neutral line, loss of the neutral line, or resonance of a capacitive load caused by switching on/off, use a surge absorber (varistor) indicated by "*" in Table 1.

(2) The case of placing the surge absorber between a line and the ground

Line-to-ground voltage may rise with a single-wire ground fault, etc. Use a recommended surge absorber in Table 1 that is different from the surge absorber placed between lines. When the device is subjected to an insulation resistance test (500 V DC), use a D-type surge absorber indicated by "*" in Table 1.

According to "Electrical Appliance Technical Standards" based on the Electrical Appliance and Material Safety Act, when using a varistor voltage which would fail the insulation performance test, the surge absorber may be removed from the device when being subjected to the test, depending on circuit test conditions.

* See attached table 4, appendix 4, "Electrical Appliance Technical Standards" based on the Electrical Appliance and Material Safety Act.

■ Current fuse

(1) Select a surge absorber and the rated current for a current fuse to be used in a manner shown in the following table.

Confirm that no secondary accident arises when the surge absorber in an actual circuit breaks. Selected rated currents of current fuses shown in the following table are exemplary one and may vary depending on circuit conditions used. Confirm the rated current by a test, etc., before using the current fuse.

<Rated currents of current fuses for the D-type / E/E-S1 series surge absorbers>

Standard product number	ERZE05A□□□□	ERZE07A□□□□	ERZE08A□□□□	ERZE10A□□□□	ERZE11A□□□□	ERZE14A□□□□
Rating Current	5 A max.	7 A max.	7 A max.	10 A max.	10 A max.	10 A max.

* Use the rated voltage of the current fuse that corresponds to the circuit voltage of a circuit including the current fuse.

(2) Recommended parts where fuses are connected are shown in Table 1. When a load current to a protected device is so large as to exceed the rated current of the fuse, however, connect the fuse in a location shown in the following diagram.

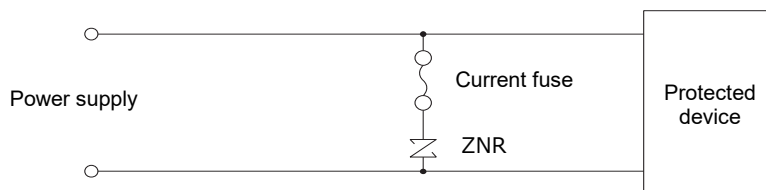

■ Temperature fuse

When connecting the surge absorber to a temperature fuse, choose a connection method and a temperature fuse that allow fine thermal coupling between the surge absorber and the temperature fuse.

Table 1 Application example of the product (ordinary application example)

	Surge absorber placed between lines	Surge absorber placed between a line and the ground																																	
Connection	<p>DC Single-phase AC</p>	<p>DC Single-phase AC</p>																																	
	<p>Three-phase AC</p>	<p>Three-phase AC</p>																																	
Varistor voltage selection	<table border="1"> <thead> <tr> <th>ZNR</th> <th>Power supply voltage [AC]</th> <th>Nominal varistor voltage</th> </tr> </thead> <tbody> <tr> <td rowspan="6">ZNR 1 ZNR 3</td> <td>100 V</td> <td>201 to 361*</td> </tr> <tr> <td>120 V</td> <td>241 to 431*</td> </tr> <tr> <td>200 V</td> <td>471 to 621*</td> </tr> <tr> <td>220 V</td> <td>471 to 621*</td> </tr> <tr> <td>240 V</td> <td>511, 621*</td> </tr> <tr> <td>380 V</td> <td>751, 821*</td> </tr> </tbody> </table>	ZNR	Power supply voltage [AC]	Nominal varistor voltage	ZNR 1 ZNR 3	100 V	201 to 361*	120 V	241 to 431*	200 V	471 to 621*	220 V	471 to 621*	240 V	511, 621*	380 V	751, 821*	<table border="1"> <thead> <tr> <th>ZNR</th> <th>Power supply voltage [AC]</th> <th>Nominal varistor voltage</th> </tr> </thead> <tbody> <tr> <td rowspan="6">ZNR 2 ZNR 4</td> <td rowspan="3">100 V 220 V</td> <td>471</td> </tr> <tr> <td>511</td> </tr> <tr> <td>621</td> </tr> <tr> <td rowspan="3">230 V 240 V</td> <td>821 or higher**</td> </tr> <tr> <td>511</td> </tr> <tr> <td>621*</td> </tr> <tr> <td>380 V</td> <td>821 or higher**</td> </tr> <tr> <td></td> <td></td> <td>112**</td> </tr> </tbody> </table>	ZNR	Power supply voltage [AC]	Nominal varistor voltage	ZNR 2 ZNR 4	100 V 220 V	471	511	621	230 V 240 V	821 or higher**	511	621*	380 V	821 or higher**			112**
	ZNR	Power supply voltage [AC]	Nominal varistor voltage																																
ZNR 1 ZNR 3	100 V	201 to 361*																																	
	120 V	241 to 431*																																	
	200 V	471 to 621*																																	
	220 V	471 to 621*																																	
	240 V	511, 621*																																	
	380 V	751, 821*																																	
ZNR	Power supply voltage [AC]	Nominal varistor voltage																																	
ZNR 2 ZNR 4	100 V 220 V	471																																	
		511																																	
		621																																	
	230 V 240 V	821 or higher**																																	
		511																																	
		621*																																	
380 V	821 or higher**																																		
		112**																																	
	<p>* Choose the element size while taking surge conditions into consideration.</p>																																		

Processing conditions

- Do not apply vibration, impact (drop impact, etc.), or pressure strong enough to crack the outer sheath resin or absorber body of the surge absorber.
- When coating the surge absorber with a resin or embedding it in a resin mold, avoid using a resin that degrades the surge absorber.
- Do not bend or apply a force to the lead of a D-type surge absorber close to the outer sheath resin.

Mounting and storage conditions

- When soldering the surge absorber, follow recommended soldering conditions shown in the following table so that solder or the insulation material making up the surge absorber is not melted.
- When making holes for mounting the surge absorber on the board, check the dimensions of the holes on the board, referencing the central point of the interval between the leads.
Because the overall dimensional tolerance is large, forming the holes with high precision requires careful processing.

	Soldering method	Recommended conditions	Mater to note
D-type	Flow soldering (solder bath immersion method)	260 °C, 10 seconds or less	A D-type surge absorber should not be soldered by reflow soldering.

Note 1: Soldering the surge absorber under soldering conditions different from the recommended soldering conditions requires extra checking to ensure it won't cause any problems.
Additional soldering is allowed only once. It must be done within 5 seconds, with the soldering iron temperature kept at 400 °C or lower.

Note 2: A temperature profile may include a large error, depending on the measurement method used.
Be careful in such cases.

Note 3: Board temperatures vary depending on the sizes of boards and mounting densities. Confirm the temperature for each type of board.

<Recommended soldering temperature profile>

Flow soldering (solder bath immersion method)

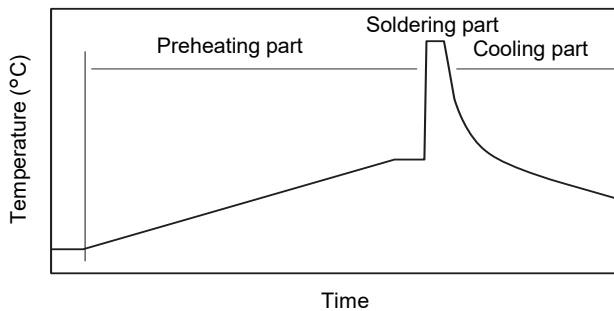

Preheating part	Normal temperature to 130 °C	120 seconds or less
Soldering part	260 °C or less	10 seconds or less
Cooling part	Gradual cooling (cooling under the normal temperature)	

- Do not keep the product in a high-temperature or high-humidity condition. Keep the surge absorber in a room with a temperature of 40 °C or lower and a relative humidity of 75% or lower and use the surge absorber within two years of storage. Check the solderability of a surge absorber stored for a long period (two years or more) before using the surge absorber.
- Keep the surge absorber in a place where no corrosive gas atmosphere (hydrogen sulfide, sulfurous acid, chlorine, ammonia, etc.) is present.
- Keep the surge absorber in a place where the surge absorber is protected from direct sunlight, dew concentration, etc.