

For operation: Power Rocker Switches
AJ7 (J7) Switches

Product Catalog

**IN Your
Future**

AJ7 (J7) Switches

6 A, 10 A Type Power Rocker Switches with a 3 mm Contact gap Secured



10 A type Standard actuator 10 A type Wide actuator 6 A type Standard actuator

FEATURES

- High inrush current resistance is ideal for power switches of office automation equipment.
- Operation that only requires a light touch
- A broad product line (TV-5 rating type available)

ORDERING INFORMATION (PART NO.)

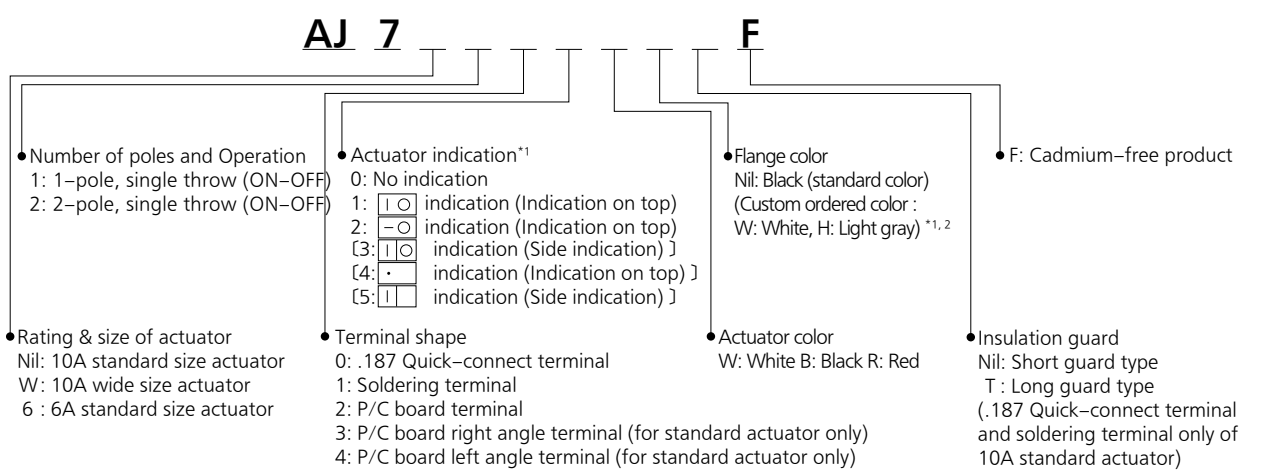

*1: For actuator indication products of asterisk [], they are custom ordered products. Available only for 10A types.
 *2: The flange color of 6A type is black only.
 Notes) 1: The correspondence between actuator colors and flange colors marked with an asterisk differs according to the type; refer to the remark for the PRODUCT TYPES.
 2: "I, O" is engraved on all flanges.
 3: The color of indication on the actuator: • White actuator: black
 • Others: white
 4: They come with a stamp indicating safety standards.

■ TV rating type

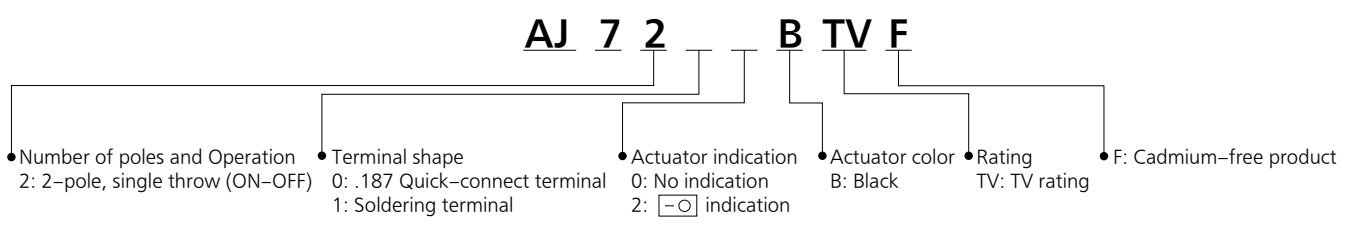

AJ7 (J7) Switches

TYPES

10 A type

1) Standard actuator type

(1) Without indication on actuators

Terminal shape	Poles	Operating types	Part No.
			Without indication
.187 Quick-connect terminal	1-pole	ON-OFF	AJ7100*F
	2-pole		AJ7200*F
Soldering terminal	1-pole		AJ7110*F
	2-pole		AJ7210*F
P/C board terminal	1-pole		AJ7120*F
	2-pole		AJ7220*F
P/C board right angle terminal	1-pole		AJ7130*F
	2-pole		AJ7230*F
P/C board left angle terminal	1-pole		AJ7140*F
	2-pole		AJ7240*F

(Standard flange color is black.)

Notes: 1. A letter indicating the actuator color is entered in place of asterisk. (W: White, B: Black, R: Red)

For custom order products with a flange color other than black, the flange color is entered after asterisk.(W: White, H: Light gray)

2. Long guard type is available for .187 Quick-connect terminal and soldering terminal type. When ordering, please add a "T" before the "F" at the end of the part number. The price is unchanged.

3. The color of indication on the actuator: white (In case white actuator: black)

4. They come with a stamp indicating safety standards.

5. Note that the position of the | mark on the flange is used as a reference for left angle and right angle terminals as shown in the diagram below. This also applies to the 6 A type.

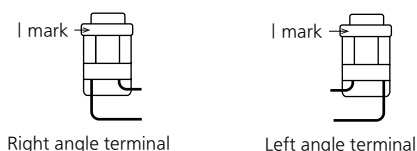

(2) With indication on actuators

Terminal shape	Poles	Operating types	Part No.	
			With ○ indication	With —○ indication
.187 Quick-connect terminal	1-pole	ON-OFF	AJ7101*F	AJ7102*F
	2-pole		AJ7201*F	AJ7202*F
Soldering terminal	1-pole		AJ7111*F	AJ7112*F
	2-pole		AJ7211*F	AJ7212*F
P/C board terminal	1-pole		AJ7121*F	AJ7122*F
	2-pole		AJ7221*F	AJ7222*F
P/C board right angle terminal	1-pole		AJ7131*F	AJ7132*F
	2-pole		AJ7231*F	AJ7232*F
P/C board left angle terminal	1-pole		AJ7141*F	AJ7142*F
	2-pole		AJ7241*F	AJ7242*F

(Standard flange color is black.)

Notes: 1. A letter indicating the actuator color is entered in place of asterisk. (W: White, B: Black, R: Red)

For custom order products with a flange color other than black, the flange color is entered after asterisk.(W: White, H: Light gray)

2. Long guard type is available for .187 Quick-connect terminal and soldering terminal type. When ordering, please add a "T" before the "F" at the end of the part number. The price is unchanged.

3. The color of indication on the actuator: white (In case white actuator: black)

4. They come with a stamp indicating safety standards.

5. Note that the position of the | mark on the flange is used as a reference for left angle and right angle terminals as shown in the diagram below. This also applies to the 6 A type.

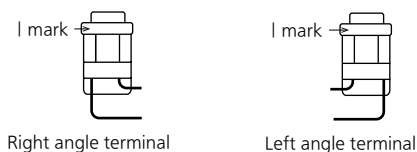

2) Wide actuator type

(1) Without indication on actuators

Terminal shape	Poles	Operating types	Part No.	
			Without indication	
.187 Quick-connect terminal	1-pole	ON-OFF	AJ7W100*F	
	2-pole		AJ7W200*F	
Soldering terminal	1-pole		AJ7W110*F	
	2-pole		AJ7W210*F	
P/C board terminal	1-pole		AJ7W120*F	
	2-pole		AJ7W220*F	

(2) With indication on actuators

Terminal shape	Poles	Operating types	Part No.	
			With ○ indication	With —○ indication
.187 Quick-connect terminal	1-pole	ON-OFF	AJ7W101*F	AJ7W102*F
	2-pole		AJ7W201*F	AJ7W202*F
Soldering terminal	1-pole		AJ7W111*F	AJ7W112*F
	2-pole		AJ7W211*F	AJ7W212*F
P/C board terminal	1-pole		AJ7W121*F	AJ7W122*F
	2-pole		AJ7W221*F	AJ7W222*F

(Standard flange color is black.)

Notes: 1. A letter indicating the actuator color is entered in place of asterisk. (W: White, B: Black, R: Red)

For custom order products with a flange color other than black, the flange color is entered after asterisk. (W: White, H: Light gray)

2. The color of indication on the actuator: white (In case white actuator: black)

3. They come with a stamp indicating safety standards.

■ 6 A type

1) Standard actuator type

(1) Without indication on actuators

Terminal shape	Poles	Operating types	Part No.	
			Without indication	
.187 Quick-connect terminal	1-pole	ON-OFF	AJ76100*F	
	2-pole		AJ76200*F	
Soldering terminal	1-pole		AJ76110*F	
	2-pole		AJ76210*F	
P/C board terminal	1-pole		AJ76120*F	
	2-pole		AJ76220*F	
P/C board right angle terminal	1-pole		AJ76130*F	
	2-pole		AJ76230*F	
P/C board left angle terminal	1-pole		AJ76140*F	
	2-pole		AJ76240*F	

(2) With indication on actuators

Terminal shape	Poles	Operating types	Part No.	
			With ○ indication	With —○ indication
.187 Quick-connect terminal	1-pole	ON-OFF	AJ76101*F	AJ76102*F
	2-pole		AJ76201*F	AJ76202*F
Soldering terminal	1-pole		AJ76111*F	AJ76112*F
	2-pole		AJ76211*F	AJ76212*F
P/C board terminal	1-pole		AJ76121*F	AJ76122*F
	2-pole		AJ76221*F	AJ76222*F
P/C board right angle terminal	1-pole		AJ76131*F	AJ76132*F
	2-pole		AJ76231*F	AJ76232*F
P/C board left angle terminal	1-pole		AJ76141*F	AJ76142*F
	2-pole		AJ76241*F	AJ76242*F

(Standard flange color is black.)

Notes: 1. Replace the asterisk with a code that indicates the actuator color.

B: Black (standard), W: White (custom ordered), R: Red (custom ordered)

2. The color of indication on the actuator: white (In case white actuator: black)

3. They come with a stamp indicating safety standards.

AJ7 (J7) Switches

TV rating type

Terminal shape	Poles	Operating types	Part No.	
			Without indication	With —○ indication
.187 Quick-connect terminal	2-pole	ON-OFF	AJ7200BTVF	—
Soldering terminal			—	AJ7202BTVF
			AJ7210BTVF	—
			—	AJ7212BTVF

RATING

Contact rating

Type	Contact voltage	Resistive load (Power factor = 1)	Motor load* (EN61058-1) (Power factor = 0.6)	Capacitor load (EN61058-1) (Inrush load)
10 A	250 V AC	10 A	4 A	100 A (8.3 ms)
6 A		6 A	3 A	—

Note: * The motor load is in accordance with EN61058-1. Inrush current can be switched up to the value of 6 times the indicated rating.

TV rating

Contact voltage	Resistive load (Power factor = 1)	Motor load (EN61058-1) (Power factor = 0.6)	Capacitor load (EN61058-1) (Inrush load)	Lamp load (UL61058-1) (TV-5)	Electrical life (at 7 cpm)
120 V AC	—	—	—	5/78 A	Min. 2.5×10^4
250 V AC	10 A	4 A	100 A (8.3 ms)	—	Min. 10^4

Specifications

Item	Specifications (common to 10 A and 6 A types)	
Expected life (Min. operations)	Mechanical	Min. 5×10^4 (at 20 cpm.)
	Electrical (at rated load)*	Min. 10^4 (at 7 cpm.)
Insulation resistance	Min. 100 MΩ (at 500 V DC measured by insulation resistive meter) (Between terminals)	
Dielectric strength	Initial, 2,000 Vrms for 1 min (detection current: 10 mA) (Between terminals)	
Contact resistance	Initial, Max. 100 mΩ (By voltage drop at 1 A, 2 to 4 V DC)	
Temperature rise (terminal section)	Max. 30°C at 6×10^3 ope. or less (UL61058-1), Max. 55°C from 6×10^3 ope. to 10^4 (EN61058-1)	
Vibration resistance	10 to 55 Hz at double amplitude of 1.5 mm (Contact opening Max. 1 msec)	
Shock resistance	Min. 980 m/s ²	
Actuator strength	40 N for 1 min (operating direction)	
Tensile terminal strength	100 N for 1 min or more (Pull & push direction)	
Ambient temperature	-25 to +85°C (no freezing and condensing)	
Flame retardancy	UL94V-0	
Tracking resistance	Min. 175	
Operating force (reference characteristics)	1-pole	2.2 ± 1.2 N
	2-pole	4 ± 2.5 N
Contact material	AgSnO ₂ alloy	

Note: Test conditions and are complying with JIS C 6571, EN61058-1 and UL61058-1.

* Except TV rating type

ACTUATOR INDICATIONS ON PRODUCTS MADE TO ORDER



With indication on top



With side indication

(When the “ I ” indication is visible on the side of the actuator, it indicates that the switch is in the “ON” state.)



With   indications: The I and O symbols are located on each side, respectively.

With  indications: The symbols is located on the side.

DIMENSIONS

CAD The CAD data of the products with a "CAD" mark can be downloaded from our Website.

Unit: mm

The dimension diagram for the standard actuator types is common to both the 10A type and the 6A type.

■.187 Quick-connect terminal/Long guard type

CAD

External dimensions

Long guard type
.187 Quick-connect terminal

Diagram of recommended
for panel mounting holes

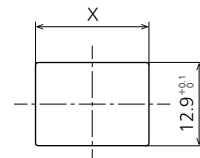
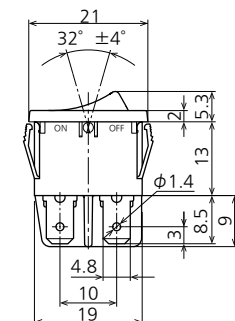
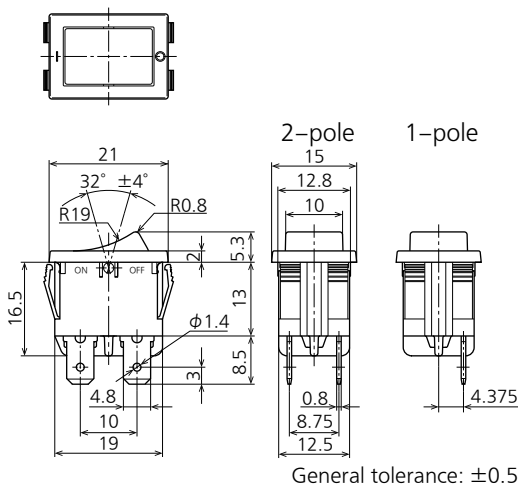

General tolerance: ±0.5

General tolerance: ±0.5

Note) As for soldering type, only terminal is different.

Panel thickness	X
0.75 to less than 1.25	19.2 ⁰ _{0.1}
1.25 or more to less than 2	19.4 ⁰ _{0.1}
2 or more to 3	19.8 ⁰ _{0.1}

■Soldering terminal

CAD

External dimensions

Long guard type
Soldering terminal

Diagram of recommended
for panel mounting holes

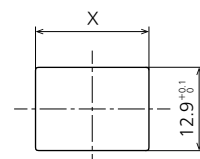
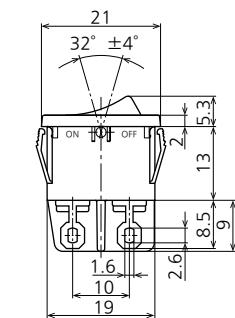
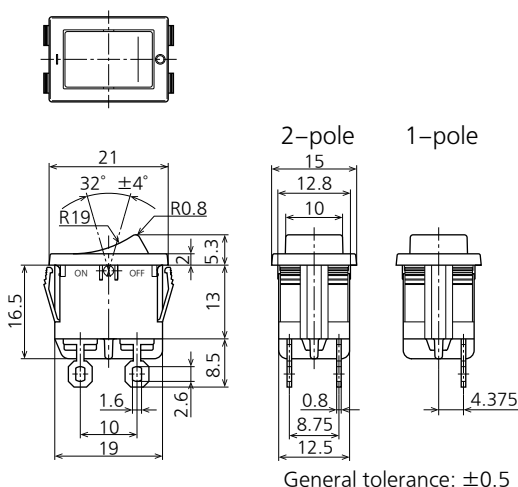

General tolerance: ±0.5

General tolerance: ±0.5

Panel thickness	X
0.75 to less than 1.25	19.2 ⁰ _{0.1}
1.25 or more to less than 2	19.4 ⁰ _{0.1}
2 or more to 3	19.8 ⁰ _{0.1}

AJ7 (J7) Switches

■ P/C board terminal

CAD



External dimensions

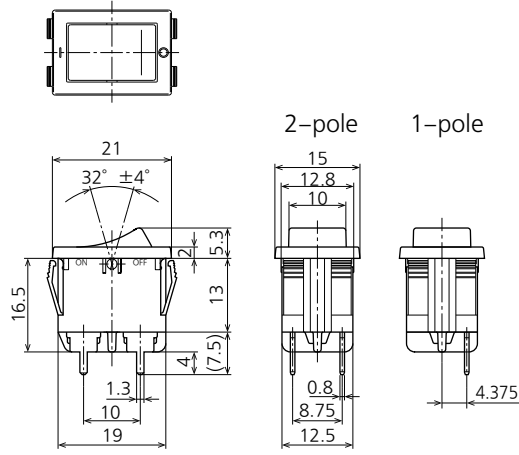

General tolerance: ± 0.5

Diagram of recommended for panel mounting holes

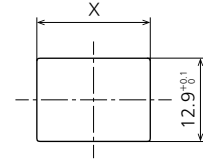

P/C board pattern

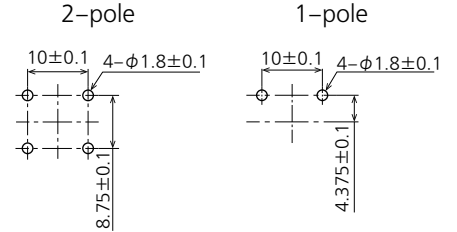

Panel thickness	X
0.75 to less than 1.25	19.2 _{0.1} ^{0.1}
1.25 or more to less than 2	19.4 _{0.1} ^{0.1}
2 or more to 3	19.8 _{0.1} ^{0.1}

■ P/C board right angle terminal

CAD



External dimensions

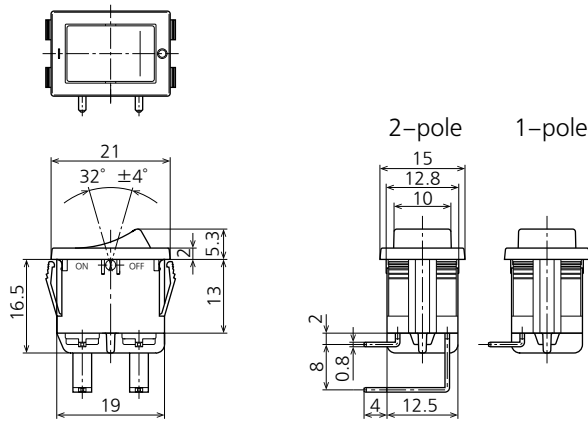

General tolerance: ± 0.5

Note) A type left angle terminals is also available.

Diagram of recommended for panel mounting holes

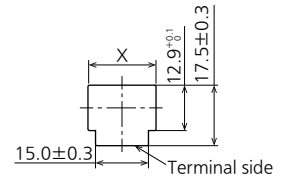

P/C board pattern

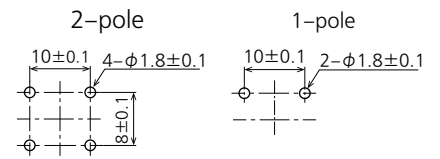

Panel thickness	X
0.75 to less than 1.25	19.2 _{0.1} ^{0.1}
1.25 or more to less than 2	19.4 _{0.1} ^{0.1}
2 or more to 3	19.8 _{0.1} ^{0.1}

Wide actuator type

CAD



External dimensions

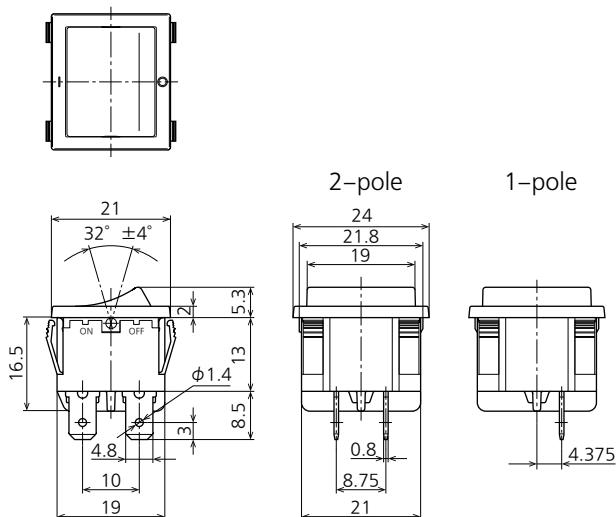

General tolerance: ±0.5

Diagram of recommended for panel mounting holes

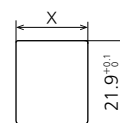

Panel thickness	X
1 to less than 1.8	19.2 ^{0.1} ₀
1.8 or more to 2.3	19.9 ^{0.1} ₀

Note: Dimensions for the terminals of soldering terminal type and P/C board terminal type are the same as those of standard size type.

Terminal circuit diagram (common)

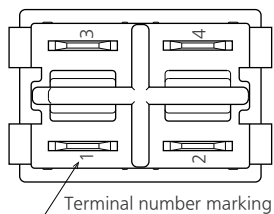

Terminal shape	Terminal circuit diagram	
	1-pole	2-pole
P/C board right angle terminal	(3) —○— (4)	(3) —○— (4) ○ — (2)
187 Quick-connect terminal Soldering terminal P/C board terminal P/C board left angle terminal	(1) —○— (2)	(1) —○— (2) ○ — (4)

GUIDELINES FOR USAGE

■ Switch mounting

Mount the switch with the hole cutting dimensions shown in the dimensions. Please contact us if you are considering using a panel of other than the recommended size and shape.

■ Regarding fastening lead wires to terminals

1) When connecting the tab terminals, use a .187 Quick-connect and insert the terminals straight in. If they are skewed, the terminals will require excessive insertion force. In addition, there is some variation in the insertion force required for different receptacles from different manufacturers, so confirm how much force is needed under actual conditions.

Do not solder wires onto tab terminals.

2) With manual soldering: Complete the soldering connection work within 3 seconds with the tip of the soldering iron at a temperature of 420°C or lower, and take care not to apply any force to the terminal area.

Avoid touching the switch with soldering iron.

Soldering position

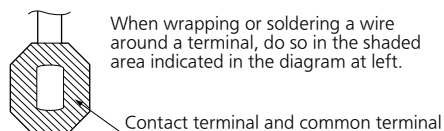

Refer to the diagram above, "soldering position," for details on the position where a wire should be soldered to a terminal. When soldering P/C board terminals, keep soldering time to within 5 seconds at 270°C soldering bath or within 3 seconds at 350°C soldering bath.

- 3) The terminals should be connected in such a way that they are not under constant stress from the connecting wires.
- 4) Terminal material is copper alloy which may discolor due to finger's oil or after a long time. But that discoloration does not effect actual performance.

INTRODUCTION TO 4P CONNECTORS FOR THE AJ7 (J7) SWITCH (produced by Nippon Tanshi Co., Ltd)

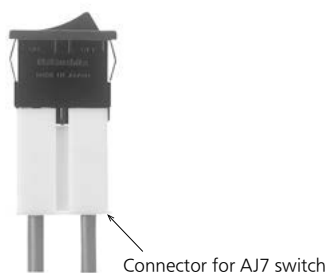

Note) This AJ7 switch connector is not available from Panasonic.

■ Resistance to chemicals

To clean the switch unit, use a neutral detergent diluted with water.

Do not use acidic or alkaline solvents as they may damage the switch.

Furthermore, be careful not to get any of the detergent solution inside of the switch while cleaning it.

■ Environment

Avoid using and storing these switches in a location where they will be exposed to corrosive gases, silicon, or high dust levels, all of which can have an adverse effect on the contacts.

■ Take care not to drop the product as it may impair performance.

Suitable switches: AJ7 (J7) switch, .187 Quick-connect terminal
(Note: Terminal guard long type switches are not suitable for this connector.)

● Housing

Product number: 4120-4□04

● Receptacle

Product number: 171901-M2

● If you have any questions, please directly contact:
Nippon Tanshi Co., Ltd.

Please refer to "the latest product specifications" when designing your product.

•Requests to customers:

<https://industrial.panasonic.com/ac/e/salespolicies/>

TECHNICAL TERMINOLOGY

■ Rated values

Values indicating the characteristics and performance guarantee standards of the switches. The rated current and rated voltage, for instance, assume specific conditions.

■ Electrical life

The service life when the rated load is connected to the contact and switching operations are performed.

■ Mechanical life

The service life when operated at a preset operating frequency without passing electricity through the contacts.

■ Dielectric strength

Threshold limit value that a high voltage can be applied to a predetermined measuring location for one minute without causing damage to the insulation.

■ Insulation resistance

This is the resistance value at the same place the dielectric strength is measured.

■ Contact resistance

This indicates the electrical resistance at the contact part. Generally, this resistance includes the conductor resistance of the spring and terminal portions.

■ Vibration resistance

Vibration range where a closed contact does not open for longer than a specified time due to vibrations during use of the snapaction switches.

■ Shock resistance

Max. shock value where a closed contact does not open for longer than a specified time due to shocks during use of the switches.

■ Allowable switching frequency

This is the maximum switching frequency required to reach the end of mechanical life (or electrical life).

■ Temperature rise value

This is the maximum temperature rise value that heats the terminal portion when the rated current is flowing through the contacts.

■ Actuator strength

When applying a static load for a certain period on the actuator in the operation direction, this is the maximum load it can withstand before the switch loses functionality.

■ Terminal strength

When applying a static load for a certain period (in all directions if not stipulated) on a terminal, this is the maximum load it can withstand before the terminal loses functionality (except when the terminal is deformed).

TYPES OF LOAD

■ Resistance load

Resistance load is a power factor of 1 ($\cos\phi = 1$) where the load is only for the resistance portion. The displayed switch rating indicates the current capacity when using AC current.

■ DC load

Differing from AC, since the direction of current is fixed for DC, the continuous arc time lengthens when the same voltage is applied.

■ Incandescent lamp load

Since an inrush current of 10 to 15 times the rated current flows for an instant when the switch is turned on for the lamp, adhesion of the contacts may occur. Therefore, please take into consideration this transient current when selecting a switch.

■ Induction load

Since arc generation due to reverse voltage can cause contact failure to occur when there is an induction load (in relays, solenoids and buzzers, etc.), we recommend you insert a suitable spark quenching circuit (see figure below).

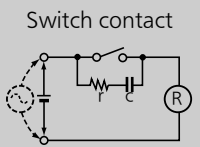
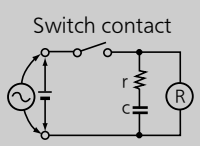
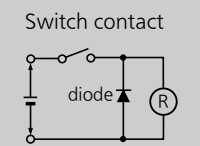
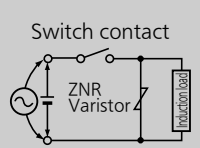
Circuit example	Notes
	(1) $r =$ more than $10\ \Omega$ (2) In an AC circuit, impedance of R is to be slightly smaller than impedance of r and c.
	Can be used for both AC and DC circuits. $r = R$ $C: 0.1\ \mu\text{F}$
	For DC circuits only.
	Can be used for both AC and DC circuits.

■ Motor load

Contacts may adhere due to the starting current at the start of motor operation which is three to eight times the steady-state current. Although it differs depending on the motor, since a current flows that is several times that of the nominal current, please select a switch taking into consideration the values in the table below. To make the motor rotate in reverse, use an ON-OFF-ON switch and take measures to prevent a multiplier current (starting current + reverse current) from flowing.

Motor type	Type	Starting current
Three-phase induction motor	Squirrel-cage	Approx. 5 to 8 times current listed on nameplate
Single-phase induction motor	Split-phase-start	Approx. 6 times current listed on nameplate
	Capacitor-start	Approx. 4 to 5 times current listed on nameplate
	Repulsion-start	Approx. 3 times current listed on nameplate

A current that is approximately two times that of the starting current will flow when reverse rotation is caused during operation. Also, when using for a load that will cause transient phenomena such as when operating the motor in reverse rotation or switching the poles, an arc short (circuit short) may occur due to the time lag between poles when switching. Please be careful.

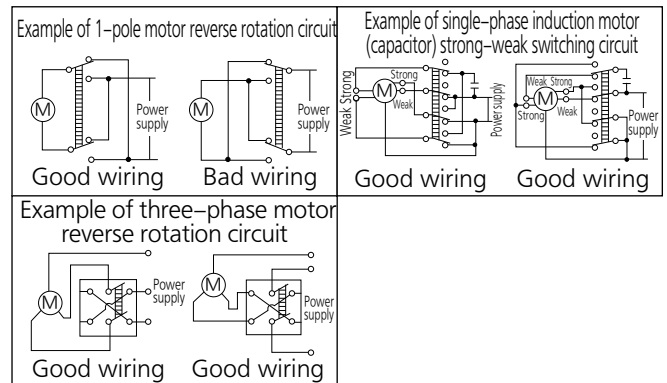

■ Capacitor load

In the case of mercury lamps, florescent lamps and the capacitor loads of capacitor circuits, since an extremely large inrush current flows when the switch is turned on, please measure that transient value with the actual load and then either use the product keeping within the range of the rated current or after verifying the actual load.

CAUTIONS FOR USE

Environment of use

- Please consult us when using under the following conditions:
 - Environments where hydrogen sulfide or other corrosive gases are present.
 - Environments where gasoline, thinner or other flammable, explosive gases are present.
 - Dusty environments (for non-seal type snap action switches).
 - Use in environments not in the prescribed temperature or humidity range.
 - Places with low air pressure.
- Unless specified the product will not be constructed to withstand water, oil or explosions. Please inquire if you intend to use the product in special applications.

Usage, storage, and transport conditions

- During usage, storage, or transportation, avoid locations subject to direct sunlight and maintain normal temperature, humidity, and pressure conditions.
- The allowable specifications for environments suitable for usage, storage, and transportation are given below.
 - Temperature: The allowable temperature range differs for each switch, so refer to the switch's individual specifications.
 - Humidity: 5 to 85% R.H.
 - Pressure: 86 to 106 kPa
The humidity range varies with the temperature. Use within the range indicated in the graph below.
(The allowable temperature depends on the switch.)

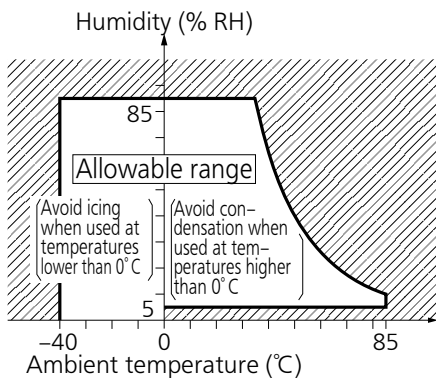

- Condensation will occur inside the switch if there is a sudden change in ambient temperature when used in an atmosphere of high temperature and high humidity. This is particularly likely to happen when being transported by ship, so please be careful of the atmosphere when shipping. Condensation is the phenomenon whereby steam condenses to cause water droplets that adhere to the switch when an atmosphere of high temperature and humidity rapidly changes from a high to low temperature or when the switch is quickly moved from a low humidity location to one of high temperature and humidity. Please be careful because condensation can cause adverse conditions such as deterioration of insulation, coil cutoff, and rust.
- Condensation or other moisture may freeze on the switch when the temperatures is lower than 0°C. This causes problems such as sticking of movable parts or operational time lags.
- The plastic becomes brittle if the switch is exposed to a low temperature, low humidity environment for long periods of time.
- Storage for extended periods of time (including transportation periods) at high temperatures or high humidity levels or in atmospheres with organic gases or sulfide gases may cause a sulfide film or oxide film to form on the surfaces of the contacts and/or it may interfere with the functions. Check out the atmosphere in which the units are to be stored and transported.
- In terms of the packing format used, make every effort to keep the effects of moisture, organic gases and sulfide gases to the absolute minimum.

Wiring

- When using a P/C board terminal switch as soldering terminals, use thin lead wires and be sure to wind them on the terminals before soldering.
- Caution when soldering
Perform soldering quickly in accordance with the specified conditions. Be careful not to let flux flow into the product. When no instruction is specified, use a soldering iron with a tip temperature of 350 C or lower and complete soldering within five seconds. Do not pull on the lead wires immediately after soldering. Wait some time before verifying.

Others

- Failure modes of switches include short-circuiting, opencircuiting and temperature rises. If this switch is to be used in equipment where safety is a prime consideration, examine the possible effects of these failures on the equipment concerned, and ensure safety by providing protection circuits or protection devices. In terms of the systems involved, make provision for redundancy in the design and take steps to achieve safety design.
- The ambient operating temperature (and humidity) range quoted is the range in which the switch can be operated on a continuous basis: it does not mean that using the switch within the rating guarantees the durability performance and environment withstanding performance of the switch. For details on the performance guarantee, check the specifications of each product concerned.
- Even if 2-pole, 3-pole or 4-pole switches are used as singlepole switches in order to increase contact reliability, please keep the maximum current no higher than the rated value.
- If there is the possibility of a short between poles, please use an in-phase circuit as shown below or provide a spare pole.

Bad example

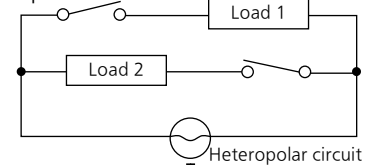

Good example①

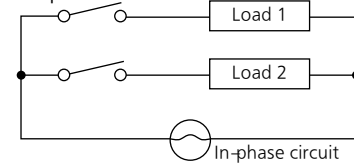

Good example②

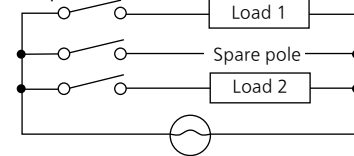

- Be careful not to drop the product as this may cause loss of functionality.
- Do not apply an unreasonable vertical force against the direction of operation of the product.
- Use your hand to operate the actuator.
(Operation using a tool such as a screwdriver or hammer can cause breakdown.)

Panasonic
INDUSTRY

Panasonic Industry Co., Ltd.

Electromechanical Control Business Division
■1006, Oaza Kadoma, Kadoma-shi, Osaka 571-8506, Japan
industrial.panasonic.com/ac/e/