

Programmable Controller

FP7 SERIES

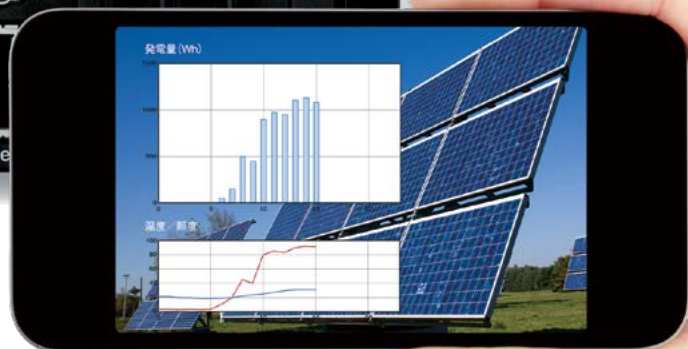

Automation Controls + Information
Panasonic PLCs also control information

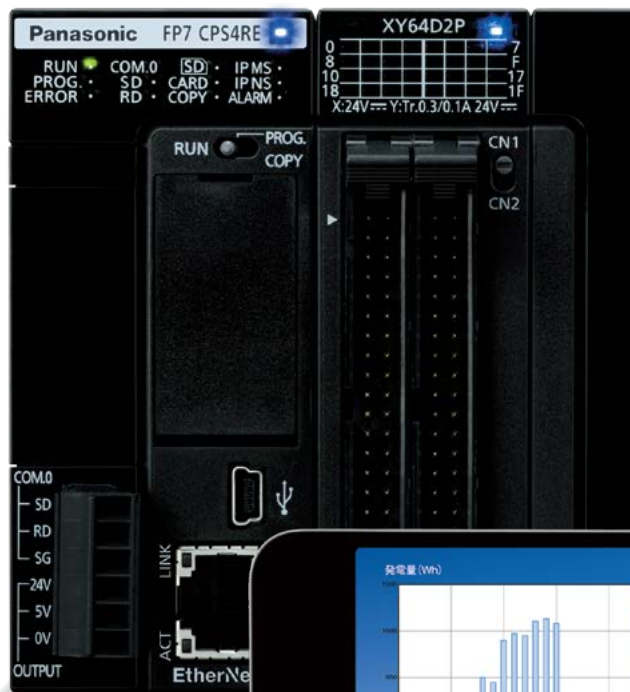

Do more than just control machinery.

Automation Controls

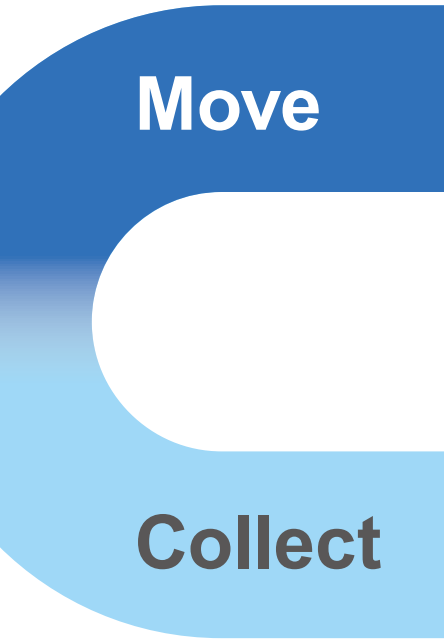
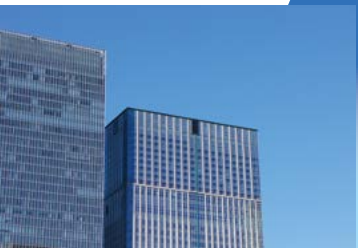

Move

Collect

Store

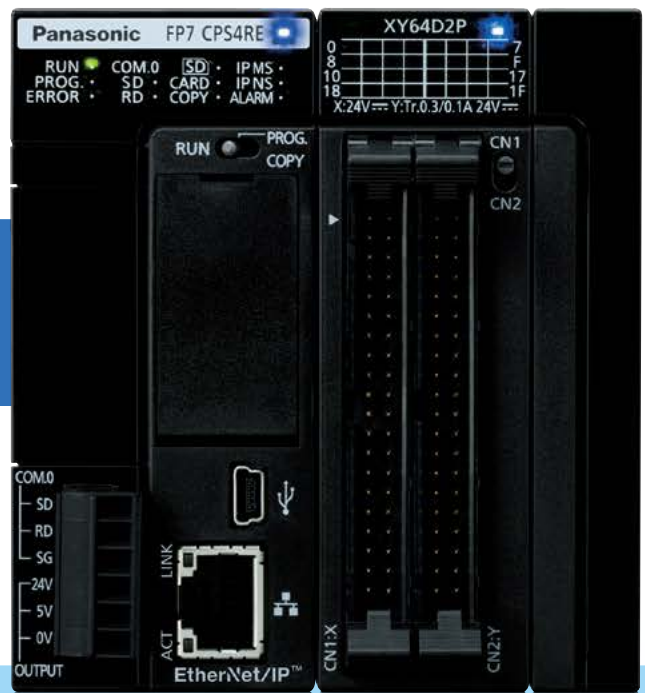

+ Information



Single PLC with two roles

Enter an era in which you can see the “current state” of the remote site.



Automation Controls

Move

Control machinery and facilities
Along with operation speed and capacity,
delivers ease of use for design, production,
and maintenance.



Compatible with industrial network Ethernet protocol

The FP7 supports EtherNet/IP and EtherCAT® and provides an integrated system through the control of sensors and servo motors, etc., and data transmission with high-order servers.

* EtherNet/IP is a trademark of ODVA, Inc.

* EtherCAT is registered trademark and patented technology, licensed by Beckhoff Automation GmbH, Germany.

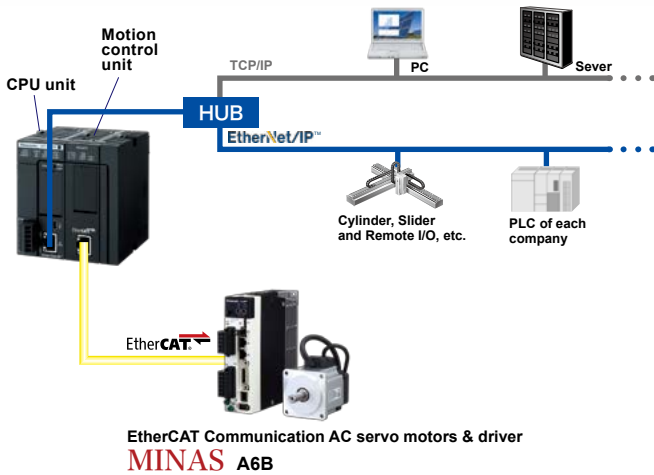

Cassette system reduces unit cost and footprint

With ease and at low cost, extend the serial communication and analog functionality of CPU units.

Serial communication cassettes

- RS-232C
- RS-422 / RS-485
- 2 channels

Function cassettes

- Analog input
- Analog input and output
- Thermocouple input

Ethernet communication cassette

* Ethernet is a registered trademark of FUJIFILM Business Innovation Corp and Xerox Corporation in the United States.

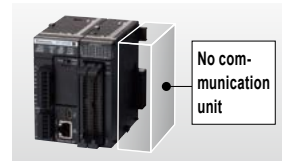

Moreover, when used as a serial communication unit, expansion to as many as 35 channels is possible. Reduces cost and footprint.

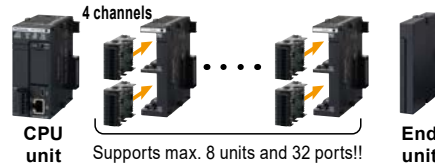

Best value model CPU unit

Ideal for Simple Standalone Systems

Achieve high-performance extensibility, lower cost and slimmer form factor.

Best value model FP7 CPU unit AFP7CPS2R

Saves space and reduces cost

Another FP7 advantage: add-on cassette system reduces unit cost and footprint.

- Function cassettes
- Analog input
 - Analog input and output
 - Thermocouple input

- Communication cassettes
- Serial
 - Ethernet

16 intelligent units can be mounted

Low in cost, 16 intelligent units can be mounted.



Analog input unit

Analog sampling that doesn't depend on CPU

Sampling and data collection in the analog unit! Ideal for high-accuracy measurement applications because with the fixed cycle, analog signal can be held in the buffer

Dependent on scan of CPU

The scan gets delayed when the CPU slows down due to other processes and sampling becomes sporadic



Sampling in the analog unit

Accurate sampling possible with fixed cycle.



- Doesn't depend on CPU scanning
- Analog buffering
- High-speed conversion: 25 μ s/ch
- Overall accuracy: $\pm 0.05\%$ F.S. (at +25 °C +77 °F)

Multi input/output unit

Select the functions you need and control various devices

Multifunctional control achieved in one unit! Supports high-speed counter input, interrupt input, pulse output, and comparison output.

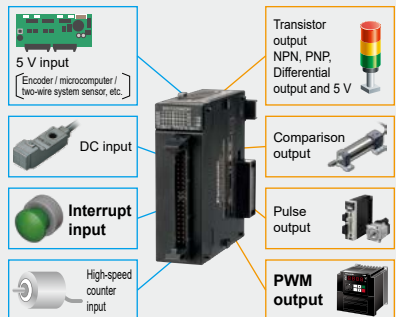

Multi Input/Output Unit AFP7MXY32DWD

Best value model CPU unit AFP7CPS2R



+ Information



Collect

Collect work site information

The FP7 can collect voltage, electric power, temperature, production output, alarm notifications, and other information.



Equipped to deal with any protocol, it can be installed in existing facilities to enable collection of information.

Communication method

- EtherNet/IP
- MC protocol
- Modbus (RTU and TCP)

Existing PLC
Existing facilities

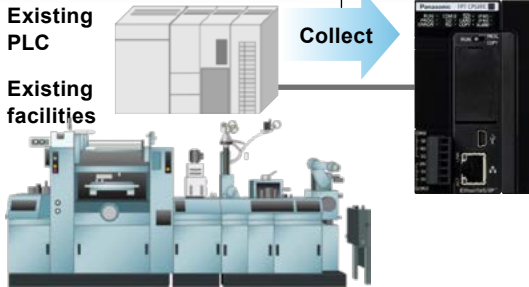

To enable information collection, because the FP7 can deal with any protocol for Ethernet / serial communications, the FP7 can be installed in existing facilities.

Communicating with up to 220 equipment units

Communicate easily with many units, including automation control equipment such as PLCs and information equipment such as PCs.

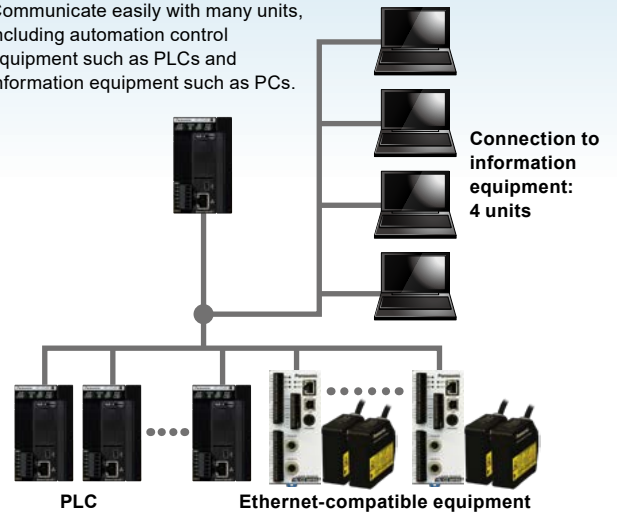

Connection to information equipment: 4 units

PLC Ethernet-compatible equipment

Connection to automation control equipment: 216 units (Simultaneous communication: 16 units)

Store

Logs collected information

The FP7 securely stores and carries out log management of collected information assets.



Easy multiple concurrent logging

Logging set up is done via the configuration screen. Moreover, it is possible to keep up to 16 files concurrently active.

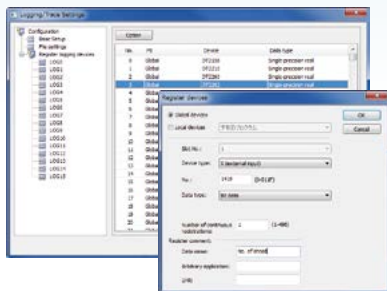

- Various triggers: periodic, cycle, bit, startup, etc.

Use program and data register sharing to resolve data space shortage. No need repurchase expensive upgrade models.

Example: 196 k steps type CPU unit AFP7CPS4RE(S)
Initial state Data-driven setting Program-driven setting

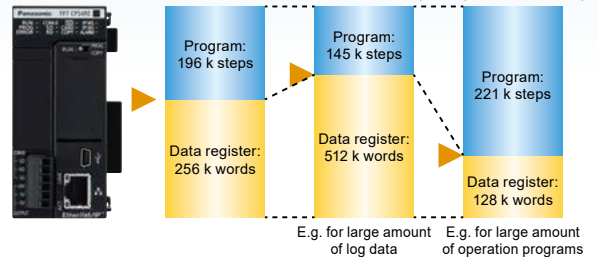

Reference value: for 196 k steps type CPU unit (Note)

Program	234 k steps	221 k steps	196 k steps	145 k steps	52 k steps
Data register	64 k words	128 k words	256 k words	512 k words	976 k words

Note: For data register (DT), data up to 256 k words can be backed up.

+ Information



Transfer

Information can be transferred to different types of media

FP7 transmits information to PC, server or the cloud, etc.

Cloud



FTP server function (SSL/TLS-compatible)

Allows the PC to read the logging data in the FP7's SD memory card and to write setting values and other parameters.

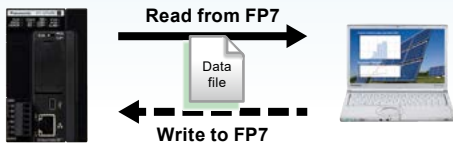

Manage your records by summarizing measurement data from your sensors together with result information from the inspection machines.

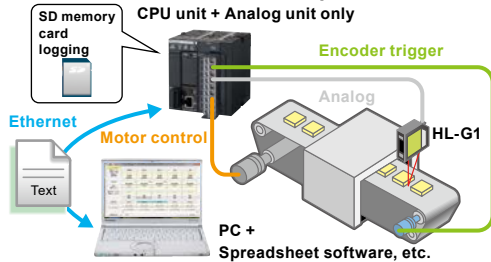

FTP(S) client function (SSL/TLS-compatible)

The FP7 can generate and write data files to an FTP server on a PC as well as read data files from the FTP server.

The sessions use SSL/TLS, protecting IDs and passwords.

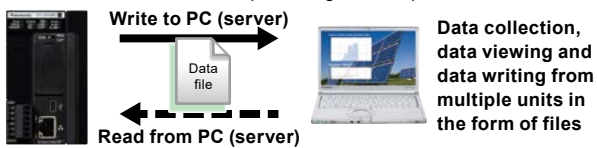

Transfer electric power data from factories and offices to an FTP server on a regular basis.



Users can access the accumulating production information in the server at any time.

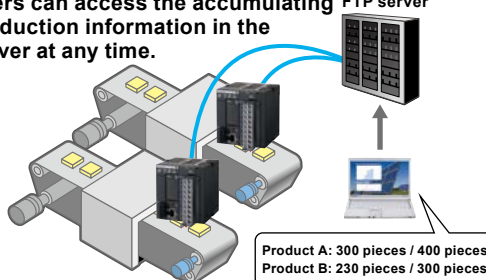

HTTP(S) client function (SSL/TLS-compatible)

Transfer data from the FP7 to a web server for easy viewing with a browser. Send and receive data from multiple FP7 units on a schedule controlled by the FP7.

Communicate both inside the firewall on an intranet and outside the firewall to the wider world through the Internet.

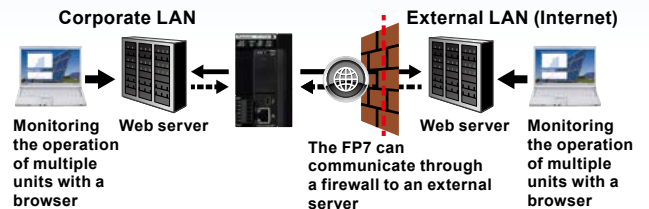

Allow users from around the world to access the current state of their equipment.

Data transfer to company server

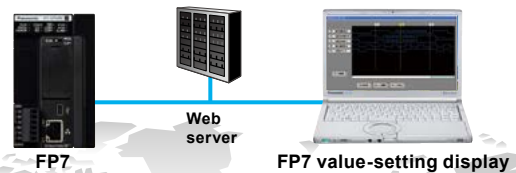

Data transfer to cloud server

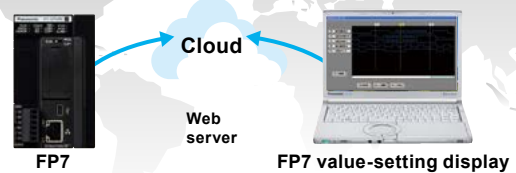

+ Information



Check

Check information at your fingertips
Data collected by the FP7 can be displayed in a web browser. Via smartphone or PC, it's easy to check the current state of the work site.



Web server function

Monitor and control the FP7 without the use of custom software. Users can check the accumulated data in the FP7 with a browser.

Information updates viewable in e-mail.

The managers can receive and view e-mailed malfunction notifications and daily reports of equipment operations.



E-mail sending function (SSL/TLS-compatible)

Use instructions and timings controlled by the FP7 to send e-mails on a pre-set schedule or when a pre-set condition changes in the PLC. The e-mails can have data files attached and communication is SSL/TLS-capable to protect the e-mails.

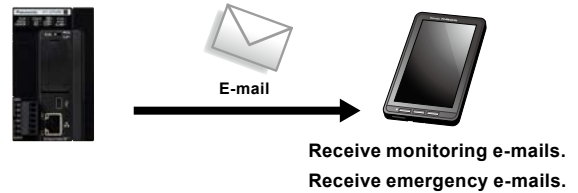

1. Check out status of greenhouse / food processing

With data always at hand, there's no need to go to the work site to check indoor temperature and humidity or the operation of pumps, heaters, and other equipment.



2. Operational status and production log management for production line

Operational status of the production line can be checked and traceability production control can be carried out. Current production line information can be collected and displayed on Web interface.

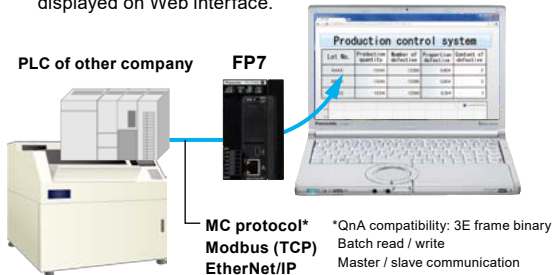

3. Building lighting / entry and exit management

Through a web interface, it is possible to check the status of lighting in buildings and apartments, and to building entries and exits.

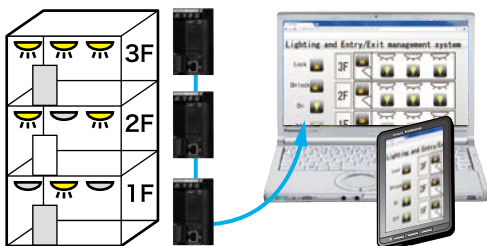

Send the results and a notice of completion when a long-term test is completed.

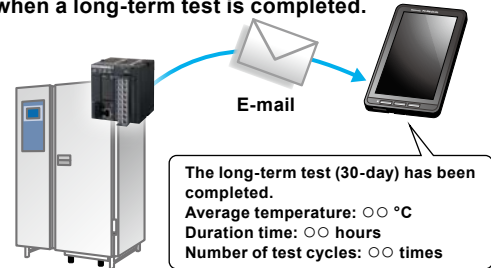

Receive a daily e-mail on your smartphone with the amount of electric power generated.

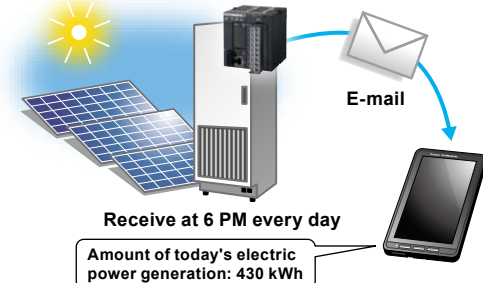

For more information on web server function, please see this catalog.



Maintenance

Historical archiving of program changes

Operational events to CPU and program editing events are logged. Useful for debugging and tracing the cause of malfunctions

Date of occurrence	Time	Trigger
2021/11/21	14:05:35	Power: ON
2021/11/21	14:07:13	Open cover
2021/11/21	14:20:25	Insert SD memory card.
2021/11/21	14:30:19	Close cover
2021/11/21	14:31:00	Download program
2021/11/21	14:33:10	Switch operation mode to RUN
2021/11/21	14:35:12	Program edition during RUN
2021/11/21	14:35:32	Upload program
2021/11/21	14:40:07	Power: OFF

*Data logs are virtual.

The built-in program backup allows users to immediately recover factory default conditions.

The CPU unit can store two programs. In the event of fault, no SD memory card is needed to return to a previously saved backup program.

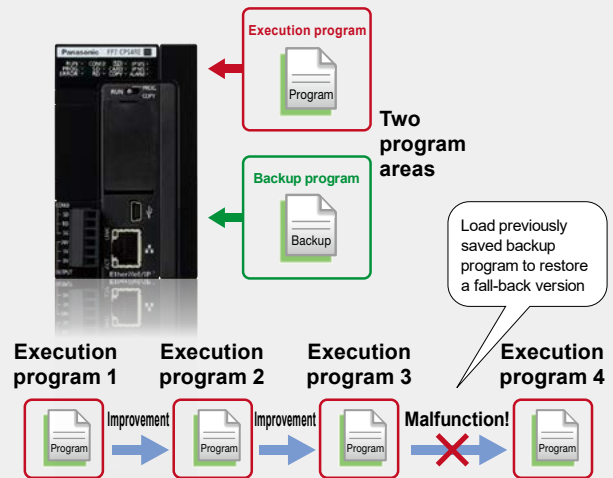

Set a maintenance schedule that is based on an automatic measurement of contact switching cycles or overall ON time.

Service intervals can be timed according to logged contact switching cycles, and power-on duration, thus enabling preventive maintenance of equipment and peripheral equipment.

Input contacts (X): Automatically measures and logs total ON times and number of ON operations of connected sensors.

Output contacts (Y): Automatically measures and logs total ON times and number of ON operations of connected actuators. The maintenance schedules for relays, motors, etc. can be optimized.

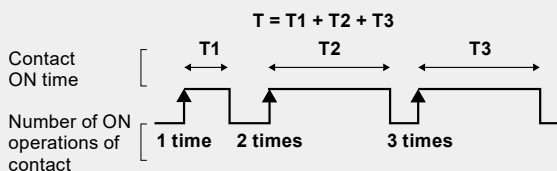

Records the PLC's ON time

Equipment operating time can be estimated. You can decide which equipment to give priority to reactivate if more than one item of equipment is idle.

No need to replace a battery by data back up function without battery.

Equipment maintenance tasks are reduced because battery is not required. And, to save power, equipment can be switched off without hesitation.



Item	Without battery	With battery
Program holding	Yes	Yes
Data register holding ^(Note 1)	Yes	Yes
Clock / calendar operation	No ^(Note 2)	Yes

Notes: 1) Data register (DT) of up to 256 k words can be backed up.
2) Clock / calendar operation can be held for about a week if the equipment is switched off. (Allow at least 30 minutes of equipment ON time.)

The built-in clock / calendar function can be adjusted via Ethernet. Adjustment at power start up allows the battery-free system to be configured.

Security and Compact design

Program level encryption ensures protection against copying program code.

Security enhanced type

Encrypted program

- Programs cannot be decrypted.
- Even if the program is copied, it will not operate.

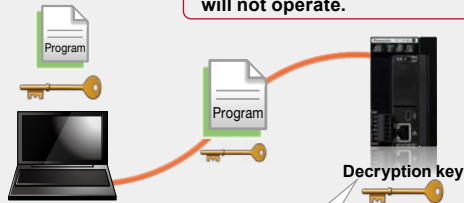

[Decryption key]

Activation is possible only if the decryption key on the FP7 matches that of the program. (Copied programs will not be activated on other FP7.)

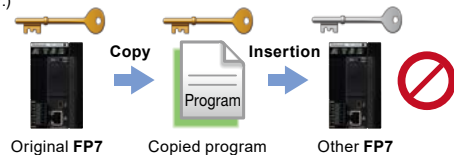

Any attempt to copy the installed equipment's program into a newly purchased FP7 will fail due to an unmatched decryption key, resulting in the equipment becoming inoperable.

*When exporting to China, please use a CPU unit that does not have an encryption function.

A high performance PLC with a small footprint.

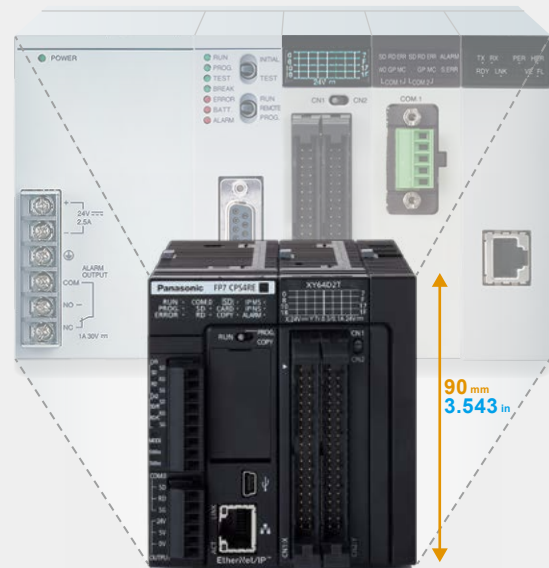

Space saving **83** mm **3.268** in

Without the requirement of a power supply unit or backplane, you can reduce the cost and footprint of your PLC configuration.

No power supply unit

No backplane

A 24 V DC power can be directly connected from the control panel.

*Add a power supply unit if AC power is required.

(Power supply unit cannot be used with AFP7CPS2R CPU unit.)

FP7 series Lineup

*Part numbers for CPU units, add-on cassettes and serial communication units have been changed accompanying changes in appearance (changes to the silk screening on the front and claws) in November 2022. Note that, structurally, old add-on cassettes cannot be installed on new CPU units and serial communication units. Also, the new add-on cassettes cannot be installed on old CPU units and serial communication units.

*The part numbers indicate new CPU units, add-on cassettes and serial communication units. The numbers in parentheses are the old part numbers.

CPU units

P.12

Standard model



EtherNet/IP
AFP7CPS4RE
(AFP7CPS41E)



EtherNet/IP
AFP7CPS3RE
(AFP7CPS31E)



AFP7CPS3R
(AFP7CPS31)



AFP7CPS2R
(AFP7CPS21)

Standard model
Security
enhanced type



EtherNet/IP
AFP7CPS4RES
(AFP7CPS41ES)



EtherNet/IP
AFP7CPS3RES
(AFP7CPS31ES)



AFP7CPS3RS
(AFP7CPS31S)

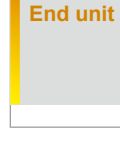

End unit
AFP7END
*Included with CPU
unit and Expansion
slave unit

Expansion units

P.13



Expansion
master unit
AFP7EXPM



Expansion
slave unit
AFP7EXPS



**Power
supply
units**
P.28
AC power
supply unit
AFP7PSA1



AC power supply unit
(High-capacity type)
AFP7PSA2

Add-on cassettes

P.14~

Communication cassettes



RS-232C
1 channel
AFP7CCRS1
(AFP7CCS1)



RS-232C
2 channels
AFP7CCRS2
(AFP7CCS2)



RS-422 / RS-485
1 channel
AFP7CCRM1
(AFP7CCM1)



RS-422 / RS-485
2 channels
AFP7CCRM2
(AFP7CCM2)



RS-232C 1 channel
and RS-485 1 channel
AFP7CCRS1M1
(AFP7CCS1M1)

Function cassettes



Ethernet
1 channel
AFP7CCRET1
(AFP7CCET1)



Analog input
AFP7FCRAD2
(AFP7FCAD2)



Analog input
and output
AFP7FCRA21
(AFP7FCA21)



Thermocouple input
AFP7FCRTC2
(AFP7FCTC2)



**Serial
communication
unit**
P.28
AFP7NSCR
(AFP7NSC)
*Communication
cassette is sold
separately
*Dedicated serial
communication

Digital input and output units

P.16~

Input units



Terminal block
16 points, 12 to 24 V
DC input
AFP7X16DW



MIL connector
32 points, 24 V
DC input
AFP7X32D2



MIL connector
64 points, 24 V
DC input
AFP7X64D2

Output units



Terminal block
16 points,
relay output
AFP7Y16R



Terminal block
16 points,
transistor output
(sink)
AFP7Y16T



MIL connector
32 points,
transistor output
(sink)
AFP7Y32T



MIL connector
64 points,
transistor output
(sink)
AFP7Y64T

Input and output
units



Terminal block
16 points,
transistor output
(source)
AFP7Y16P



MIL connector
32 points,
transistor output
(source)
AFP7Y32P



MIL connector
64 points,
transistor output
(source)
AFP7Y64P



MIL connector
32 points, 24 V DC input
32 points, transistor output
(sink)
AFP7XY64D2T



MIL connector
32 points, 24 V DC input
32 points, transistor output
(source)
AFP7XY64D2P

Analog input and output units
P.19

Input units



High-speed and high-accuracy type
4 points, voltage and current
AFP7AD4H



High-speed and multi-channel type
8 points, voltage and current
AFP7AD8

Output unit



Analog output unit
High-speed and high-accuracy type
4 points, voltage and current
AFP7DA4H

Temperature input units
P.20

Thermocouple multiple analog input unit



Thermocouple input and analog input
AFP7TC8

Resistance temperature detector input unit



Resistance temperature detector input
AFP7RTD8

High-speed counter units
P.21



2 channels
16 MHz (for 2-phase, 4-multiple)
4 MHz (for individual input)
AFP7HSC2T



4 channels
16 MHz (for 2-phase, 4-multiple)
4 MHz (for individual input)
AFP7HSC4T

Positioning units
P.22

Pulse train



Transistor output
2 axes
500 kpps
AFP7PP02T



Transistor output
4 axes
500 kpps
AFP7PP04T



Line driver output
2 axes
4 Mpps
AFP7PP02L



Line driver output
4 axes
4 Mpps
AFP7PP04L

Pulse output units
P.23



Transistor output
2 axes
500 kpps
AFP7PG02T



Transistor output
4 axes
500 kpps
AFP7PG04T



Line driver output
2 axes
4 Mpps
AFP7PG02L



Line driver output
4 axes
4 Mpps
AFP7PG04L

Motion control units
P.24



Real axis: 16 axes
Virtual axis: 8 axes
AFP7MC16EC



Real axis: 32 axes
Virtual axis: 16 axes
AFP7MC32EC



Real axis: 64 axes
Virtual axis: 32 axes
AFP7MC64EC

Multi input/output units
P.25



16 points, input (DC / counter, etc.)
16 points, output (transistor / PWM, etc.)
AFP7MX32DWD

PHLS (remote I/O) units
P.26~

PHLS master unit



AFP7PHLSM

PHLS slave units
Input type



Compact type (e-CON)
8 points, 24 V DC input
AFP7P2X08D2E



Compact type (Connector-type terminal block)
16 points, 24 V DC input
AFP7P2X16D2



Standard type (Screw-type terminal block)
8 points, 24 V DC input
AFP7P1X08D2



Standard type (Screw-type terminal block)
16 points, 24 V DC input
AFP7P1X16D2

PHLS slave units
Output type



Compact type (Connector-type terminal block)
16 points, transistor output (sink)
AFP7P2Y16T



Compact type (Connector-type terminal block)
4 points, relay output
AFP7P2Y04R



Standard type (Screw-type terminal block)
16 points, transistor output (sink)
AFP7P1Y16T

PHLS slave units
Input and output types



Compact type (Connector-type terminal block)
8 points, 24 V DC input
8 points, transistor output (sink)
AFP7P2XY16D2T



Standard type (Screw-type terminal block)
8 points, 24 V DC input
8 points, transistor output (sink)
AFP7P1XY16D2T

Multi-wire link unit
P.29



AFP7MW

Orders to end on September 29, 2023

CPU units

Basic performance [For AFP7CPS4RE(S)]

- Operation speed: Min. 11 ns/step
- Program capacity: 196 k steps
- Data registers: 256 k words
- Number of unit connection: Max. 16 units

Compact design and class-leading high performance



- 1. The function is expanded easily with cassette interface.**
The function extension is possible without increasing the width of the unit. The cassettes support RS-232C, RS-422 and RS-485 for series communication, Ethernet communication and various analog input and output.
- 2. High-capacity SD (SDHC) memory cards of up to 32 GB are supported.**
Enables large storage for log data *except for AFP7CPS2R
- 3. High performance**
Scan times of 20 μs or less and minimum execution times of 1 ms at 60 k steps. System is designed so that frequent Ethernet communication has almost no effect on processing speed.
- 4. All communications ports are safely isolated.**
Confidently use any port - RS-422 / RS-485 and LAN ports, as well as USB and RS-232C ports - each is isolated.
- 5. High function types, increased security (encryption), are available.**

*When exporting to China, please use a CPU that does not have an encryption function.

Control specifications

Item	AFP7CPS4RE(S) (Note 6)					
Memory capacity	Memory selection pattern (Note 1)	1	2	3 (Factory default)	4	5
	Program (steps) (Note 2)	234,000	221,500	196,000	144,500	51,500
	Data register (words) (Note 2)	65,536	131,072	262,144	524,288	999,424
	Number of max. program block (PB)	468	443	392	289	103
Item	AFP7CPS3RE(S) / AFP7CPS3R(S) (Note 6)					
Memory capacity	Memory selection pattern (Note 1)	1 (Factory default)	2	3	4	
	Program (steps) (Note 2)	121,500	96,000	64,000	32,000	
	Data register (words) (Note 2)	131,072	262,144	425,984	589,824	
	Number of max. program block (PB)	243	192	128	64	
Item	AFP7CPS2R					
Memory capacity	Memory selection pattern (Note 1)	1 (Factory default)	2			
	Program (steps) (Note 2)	64,000	32,000			
	Data register (words) (Note 2)	131,072	262,144			
	Number of max. program block (PB)	128	64			
Item	AFP7CPS4RE(S) / AFP7CPS3RE(S) / AFP7CPS3R(S) / AFP7CPS2R					
Programming method	Relay symbol method					
Control method	Cyclic operation method					
Program memory	Built-in flash ROM (no backup battery required)					
Operation speed	Basic instruction: Min. 11 ns/step (AFP7CPS2R: 14 ns/step)					
External input (X) / output (Y)	8,192 points (Note 4) / 8,192 points (Note 4)					
Internal relays (R)	32,768 points					
System relays (SR)	Indicate operation status of various relays is shown.					
Link relays (L)	16,384 points					
Timers (T)	4,096 points: Timer capable of counting (units: 10 μs, 1 ms, 10 ms, 100 ms or 1 sec.) × 4,294,967,295					
Counters (C)	1,024 points, Counter capable of counting 1 to 4,294,967,295					
Link data registers (LD)	16,384 words					
System data registers (SD)	Internal operation status of various registers is shown.					
Index registers (I0 to IE)	15 long words / With switching function					
Master control relay (MCR)	Unlimited					
Number of labels (LOOP)	Max. 65,535 points for each program block (PB)					
Differential points	Unlimited					
Number of step ladders	Unlimited					
Number of subroutines	Max. 65,535 points for each program block (PB)					
Number of interrupt programs	1 periodical interrupt program					
SD memory card function	SDHC memory cards of up to 32 GB are usable. *except for AFP7CPS2R					
Constant scan	Available (0 to 125 ms)					
Clock / calendar (Note 3)	Year (last two digits), month, day, hours (24-hour display) minutes, seconds, day of week					
Battery life	3.3 years or more (at +25 °C +77 °F) (when no power is supplied) *except for AFP7CPS2R					
Security function (Note 5)	Password / Restricted distribution / Read disable setting / Encryption					
PLC link function (Serial communication / MEVNET-W0)	Max. 16 units, link relays: 1,024 points, link registers: 128 words. (Data transfer and remote programming are not supported) (Link area allocation is switchable between the first and the second half)					

- Notes: 1) The factory default setting is pattern 3 for AFP7CPS4RE(S) and pattern 1 for AFP7CPS3RE(S), AFP7CPS3R(S) and AFP7CPS2R.
 2) For data register (DT), data up to 262,144 words can be backed up.
 3) Precision of calendar: At 0 °C +32 °F, 95 sec. or less error per month, at +25 °C +77 °F, 15 sec. or less error per month, at +55 °C +131 °F, 130 sec. or less error per month.
 4) Hardware configuration governs the actually usable number of I/O points. When I/O points are not actually used, usable as internal relays.
 5) Encryption can be used for AFP7CPS4RE(S), AFP7CPS3RE(S) and AFP7CPS3R(S).
 6) Products with an "S" at the end of a part number have the encryption function.

COM port communication specifications

Item	Specifications
Interface	RS-232C, three-wire system, 1 channel (Note)
Transmission distance	15 m 49.213 ft
Transmission speed	300, 600, 1200, 2400, 4800, 9600, 19200, 38400, 57600, 115200, 230400 bits/sec.
Communication method / Synchronous method	Half-duplex system / Start-stop synchronization system
Transmission format	Stop bit: 1 bit / 2 bits
	Parity: none / odd / even
	Data length: 7 bits / 8 bits
	Start code: with STX / without STX
Data transmission order	End code: CR / CR + LF / none / ETX
	Transmit from bit 0 in character units.
Communication mode	General-purpose communication, Computer link and MODBUS-RTU

Note: SD, RD and SG terminals are isolated from internal circuits.

Dedicated power supply output port specifications for GT series programmable display

Output terminal (Note 1)	Connecting programmable display model
5 V	For 5 V DC type GT series Programmable Display
24 V (Note 2)	For 24 V DC type GT series Programmable Display

- Notes: 1) 5 V and 24 V DC types are not usable at the same time.
 2) Use 21.6 to 26.4 V DC to power the CPU unit.
 Please check the "GT Series Manual" for grounding of the GT series programmable display.
 The AFP7CPS2R is not provided with this port.

LAN port communication specifications [except for AFP7CPS3R(S) / AFP7CPS2R]

Item	Specifications
Communication interface	Ethernet 100BASE-TX / 10BASE-T
Baud rate	100 Mbps, 10 Mbps auto negotiation function
Total cable length	100 m 328 ft (500 m 1,640 ft when a repeater is used)
Number of nodes	254 units
Number of simultaneous connections	Max. 220 connections (user connection: 216, system connection: 4)
Communication protocol (Communication layer)	TCP/IP, UDP
DNS	Supports name servers
DHCP / DHCPV6	Automatic IP address acquisition
FTP server / Client (SSL/TLS compatible)	Server function: file transfer, number of user: 3 Client function: data and file transfer
HTTP server / Client (SSL/TLS compatible)	Server function: system web, Customer web (8 MB), number of concurrent session: 16 Client function: data transfer
SMTP client (SSL/TLS compatible)	Client function: mail transfer
SNTP	Time adjustment function
General-purpose communication	16 kB / 1 connection (user connection: 1 to 16)
Dedicated communication	EtherNet/IP
	MEWTOCOL-COM (master/slave)
	MEWTOCOL-TCP (slave)
	MODBUS-TCP (master/slave)
	MEWTOCOL-DAT (master/slave)
MC protocol (Note)	(master/slave)

Note: MC protocol is a short form denoting MELSEC communication protocol; MELSEC is a registered trademark of Mitsubishi Electric Corporation.
 QnA compatible 3E frame, only binary (bulk writing and bulk reading) use is available.

CPU units

Web server specifications

Item	Specifications
Compatible CPU unit	Ver. 3.30 or later CPU unit with built-in Ethernet function
Web server	Number of simultaneous accesses: 16 sessions System Web: system monitor function Custom Web: 13.83 MB max. content capacity
Control Web Creator compatible OS	Windows® 7 or higher
Web server accessible browsers	Windows® Google Chrome Mozilla Firefox Opera Internet Explorer OS X Safari Google Chrome Mozilla Firefox iOS Safari Google Chrome Android Google Chrome

Notes: 1) Windows and Internet Explorer are registered trademarks or trademarks of Microsoft Corporation in the United States and other countries. Google Chrome and Android are registered trademarks of Google Inc. Safari and OS X are trademarks or registered trademarks of Apple Inc. in the United States and other countries. iOS is a trademark or registered trademark of Cisco Systems, Inc. in the United States and other countries. Firefox is a registered trademark of Mozilla Foundation in the United States and other countries. Opera is a trademark or registered trademark of Opera Software ASA.
2) Please use the latest OS and browser versions. Latest browser versions may not work with older models.

Firmware can be updated to latest version!

Update tool for latest firmware version is available on our website. Web server function can be added to CPU units listed above with built-in Ethernet function.

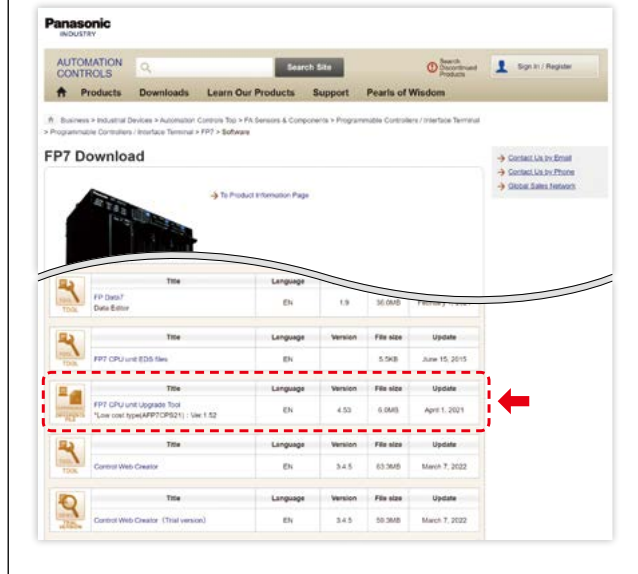

Expansion units

Connect a maximum of 3 blocks and a total of 64 units

Three blocks can be expanded on one CPU unit.

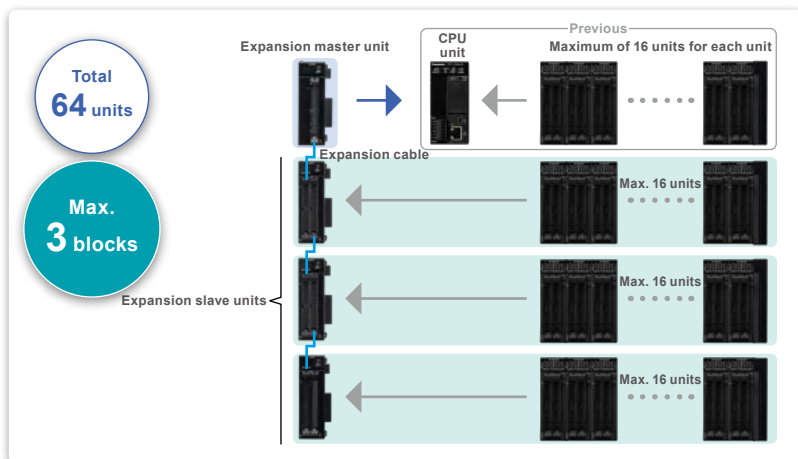

Specifications

Item	Product name	Expansion master unit	Expansion slave unit
	Part No.	AFP7EXPM	AFP7EXPS
Number of expansion	Block	Max. 3 blocks (total 4 blocks)	
	Unit	Max. 48 units (total 64 units)	
Transmission distance	Distance between blocks	Length of expansion cable (0.5 m 1.640 ft, 1 m 3.281 ft, 3 m 9.843 ft and 10 m 32.808 ft)	
	Total extension	Max. 30 m 98.425 ft (Expansion cable × 3 expansions) (Note 1)	
Current consumption (Note 2)		120 mA or less	100 mA or less
Max. allowable current		–	3.0 A (at 24 V DC power supply terminal)
Expansion bus connector		MIL 40 pins	MIL 40 pins × 2
Accessories		–	Power supply cable (Part No.: AFP805) End unit (Part No.: AFP7END)

Notes: 1) Can support a maximum of 100 m 328 ft length between blocks. Please inquire with us for details.
2) Differs depending on power supply voltage and number of expansion units.
3) You cannot use the expansion units with the AFP7CPS2R CPU unit.

Add-on cassettes (communication cassettes)

For communication with programmable displays or PCs and for data exchange between PLCs



1. Serial communication and Ethernet communication can be added to the CPU unit.

6 types are available including cassettes that support any combination of RS-232C, RS-422, RS-485 and Ethernet.

[Configuration example]

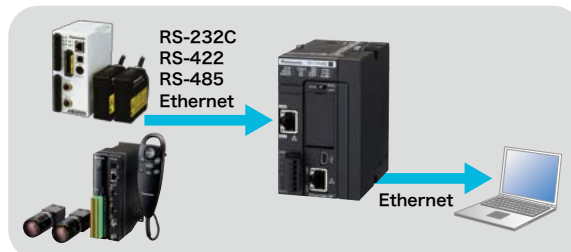

* Ethernet function (including FTP server / client function, HTTP client function, Web server function and E-mail sending function) cannot be used in the AFP7CCRET1.

2. Protocol supports MODBUS-RTU.

Communication can easily be accomplished using comfortable communication instructions.

* The AFP7CCRET1 supports MODBUS-RTU as well, and does not support MODBUS-TCP.

Specifications

Item	AFP7CCRS1	AFP7CCRS2 (Note 7)	AFP7CCRM1 (Note 6)	AFP7CCRM2 (Note 6)	AFP7CCRS1M1
Interface	RS-232C 1 channel	RS-232C 2 channels	RS-422 or RS-485 1 channel	RS-422 or RS-485 2 channels	RS-232C 1 channel and RS-485 1 channel
Transmission distance	Max. 15 m	49,213 ft (Note 2)	Max. 1,200 m 3,937 ft at RS-485 mode (Note 3 and 4) Max. 400 m 1,312 ft at RS-422 mode (Note 3 and 4)	Max. 15 m	49,213 ft (RS-232C) (Note 2) Max. 1,200 m 3,937 ft (RS-485) (Note 3 and 4)
Transmission speed	300, 600, 1200, 2400, 4800, 9600, 19200, 38400, 57600, 115200, 230400 bits/sec.				
Communication method	Half-duplex				
Synchronous method	Start-stop synchronization				
Transmission format	Stop bit: 1 bit / 2 bits				
	Parity: none / odd / even				
	Data length: 7 bits / 8 bits				
	Start code: with STX / without STX				
Data transmission order	End code: CR / CR + LF / none / ETX				
Max. number of stations (Note 2, 3 and 4)			For program controlled communication: max. 99 (Note 8)		For program controlled communication: max. 99
			For computer link: max. 99 (Note 8)		For computer link: max. 99
			For PLC link: max. 16 (Note 8)		For PLC link: max. 16
			For MODBUS-RTU: max. 99 (Note 8)		For MODBUS-RTU: max. 99

Notes: 1) When connecting a commercially available device that has an RS-485 / RS-422 interface, please confirm operation using the actual device.

In some cases, the number of station units, transmission distance and communication speed vary depending on the connected device.

2) Cable length should be no longer than 3 m 9.843 ft if communicating at a rate of 38.4 kbits/sec. or higher.

If you are using RS-232C wiring, shielded cable should be used to improve noise immunity.

3) For RS-485 setting, the values for transmission distance, transmission speed and number of connected units should be within the values noted in the graph below.

Maximum number of stations in RS-485 communications

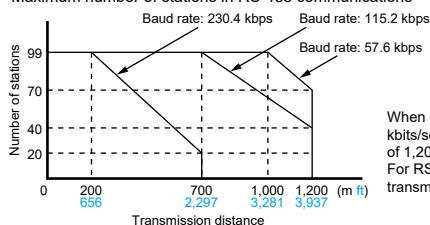

When using a transmission speed of 38.4 kbits/sec. or less, you can set up a maximum of 1,200 m 3,937 ft and 99 units.

For RS-422 setting, you can set up a maximum transmission distance of 400 m 1,312 ft.

4) If mixed C-NET adapters are used, up to 32 units can be connected, but transmission speed will be limited to a maximum of 19.2 kbits/sec..

5) The converter SI-35 manufactured by LINE EYE Co., Ltd. is recommendable for the RS-485 at the computer side.

When you use the SI-35, please adjust time after PF7 series PLC receives a command until it returns a response by a program.

6) RS-422 or RS-485 can be selected using the DIP switch built into the communication cassette.

7) Using the DIP switch built into the communication cassette allows the interface to be used as RS-232C 5-wire system × 1 channel.

8) 1:1 for RS-422 interface

Item	AFP7CCRET1
Interface	Ethernet 100BASE-TX / 10BASE-TX
Communication speed	100 Mbps, 10 Mbps Auto negotiation function
Total cable length	100 m 328 ft (500 m 1,640 ft when a repeater is used)
Number of nodes	254 units
Number of simultaneous connections	Max. 4 connections (User connection: 3, System connection: 1)
Communication protocol (Communication layer)	TCP / IP, UDP
DHCP	Automatic IP address acquisition
General-purpose communication	4 kB / 1 connection
Dedicated communication	Slave communication (MEWTOCOL-COM, MEWTOCOL7-COM, MEWTOCOL-DAT)
	Master communication (MEWTOCOL-COM, MEWTOCOL7-COM, MEWTOCOL-DAT)

Notes: 1) Please connect the Ethernet cable with the power turned off.

2) You cannot use this cassette "AFP7CCRET1" with the serial communication unit.

3) Ethernet function (including FTP server / client function, HTTP client function, Web server function and E-mail sending function) cannot be used.

Add-on cassettes (function cassettes)

Add Analog I/O, temperature input function



1. Analog I/O and temperature input functions can be added to the CPU unit.

Low cost expansion of the CPU unit with an analog function is easy and installation space can be reduced.



Analog cassette

- Analog input (2 channels)
- Analog input and output (input: 2 channels, output: 1 channel)
- Thermocouple (2 channels)

2. Low cost addition of functions

Reduced cost and space are realized compared to the analog input and output unit.

Analog input cassette / Analog input and output cassette

■ Input specifications (AFP7FCRAD2 / AFP7FCRA21)

Item		AFP7FCRAD2 / AFP7FCRA21	
Input specifications	Number of input points	2 channels (non-insulated between channels)	
	Input range	Voltage	0 to 10 V / 0 to 5 V *Switch setting (individual settings possible)
		Current	0 to 20 mA
	Digital conversion value	K0 to K4000	
	Resolution	1/4000 (12 bits)	
	Conversion speed	1 ms/channel	
	Overall precision	±1 % F.S. or less (0 to +55 °C +32 to +131 °F)	
	Input impedance	Voltage	1 MΩ
		Current	250 Ω
	Absolute maximum input	Voltage	-0.5 V, +15 V
		Current	30 mA
	Insulation method	• Between analog input terminal and internal digital circuit: transformer insulation, isolation IC insulation • Between analog input terminal and analog output terminal: transformer insulation, isolation IC insulation	
	Connection method	Connector type terminal block	

Note: Input specifications of the analog I/O cassette and analog input cassette are the same.

Analog input and output cassette

■ Output specifications (AFP7FCRA21)

Item		AFP7FCRA21	
Output specifications	Number of output points	1 channel	
	Output range	Voltage	0 to 10 V / 0 to 5 V *Switch setting
		Current	0 to 20 mA
	Digital conversion value	K0 to K4000	
	Resolution	1/4000 (12 bits)	
	Conversion speed	1 ms/channel	
	Overall precision	±1 % F.S. or less (0 to +55 °C +32 to +131 °F)	
	Output impedance	0.5 Ω (voltage output)	
	Max. output current	10 mA (voltage output)	
	Absolute output load resistance	600 Ω or less (current output)	
	Insulation method	• Between analog input terminal and internal digital circuit: transformer insulation, isolation IC insulation • Between analog input terminal and analog output terminal: transformer insulation, isolation IC insulation	
	Connection method	Connector type terminal block	

Note: There is no analog output functionality in the analog input cassette.

Thermocouple cassette

■ Specifications (AFP7FCRTC2)

Item		AFP7FCRTC2
Number of input points		2 channels (insulated between channels)
Input range (Note)	K type thermocouple	-50.0 to 500.0 °C -58.0 to 932.0 °F
	J type thermocouple	-50.0 to 500.0 °C -58.0 to 932.0 °F
Digital conversion value	Normal time	K-500 to K5000
	When range over	K-501, K5001 or K8000
	When the thermocouple broken	K8000
When data preparation	K8001	
Resolution	0.2 °C (Display is 0.1 °C with the software averaging process.)	
Sampling cycle	100 ms / 2 channels	
Overall precision	±0.5 % F.S. or less and cold contact accuracy: 1.5 °C (0 to +55 °C +32 to +131 °F)	
Input impedance	344 kΩ	
Insulation method	• Between thermocouple input terminal and internal digital circuit: transformer insulation, isolation IC insulation • Between thermocouples: transformer insulation, isolation IC insulation	
Connection method	Connector type terminal block	

Note: Thermocouple setting can be switched with the switch on the front of the cassette.

Digital input and output units

I/O points can be added as necessary.



1. Input/output mixed units are available.

The necessary I/O points can be efficiently obtained, resulting in a compact PLC at reduced cost.

2. The 64 points transistor output unit is designed for 300 mA current capacity.

The 64 points transistor output unit is equipped with 8 contact points with 300 mA current capacity. Large indicator lamps, magnetic contacts, etc. can be driven directly.



3. The noise countermeasure is possible by an adjustment of the input time constants.

Response time can be selected from 0.1 ms, 0.5 ms, 1 ms, 5 ms, 10 ms, 20 ms or 70 ms, depending on the output equipment to be used.



Input specifications

Item	DC input units			I/O mixed unit (input side)		
	16 points type	32 points type	64 points type	DC input / sink type	DC input / source type	
Insulation method	24 V DC			24 V DC		
Rated input voltage	12 to 24 V DC	24 V DC			24 V DC	
Rated input current	6 mA approx. (at 24 V)	2.7 mA			2.7 mA	3.4 mA
Impedance	3.6 kΩ	8.2 kΩ			8.2 kΩ	7.5 kΩ
Min. ON voltage / min. ON current	9.6 V / 2 mA	19.2 V / 2.5 mA			19.2 V / 2.5 mA	
Max. OFF voltage / max. OFF current	2.5 V / 1 mA	5 V / 1.5 mA			5 V / 1.5 mA	
Response time	OFF→ON	0.1 ms or less (Note)	0.2 ms or less (Note)		0.2 ms or less (Note)	
	ON→OFF	0.2 ms or less (Note)	0.2 ms or less (Note)		0.2 ms or less (Note)	
Input points per common	8 points/common	32 points/common		32 points/common		
Connection method	Terminal block (M3 terminal screws)	Connector (MIL-compliant 40 pins)	Connector (MIL-compliant 40 pins, two use)		Connector (MIL-compliant 40 pins)	

Note: Changeable by settable input time constant

Output specifications

Item	Relay output unit	Transistor output units				I/O mixed unit (output side)	
	16 points type	16 points (NPN)	32 points (NPN)	64 points (NPN)	16 points (PNP)	32 points (NPN)	
Insulation method	Relay	Photocoupler					
Nominal switching capacity	2 A 250 V AC / 2 A 30 V DC	-	-	-	-	-	
Min. load	1 mA 100 mV DC (resistive load)	-	-	-	-	-	
Output type	-	Open collector					
Rated load voltage	-	5 to 24 V DC					
Operating load voltage range	-	4.75 to 26.4 V DC					
Max. load current	0.3 A (Y0 to Y7)	1 A	0.3 A (26.4 to 20.4 V DC) 30 mA (4.75 V DC)	0.3 A (20.4 to 26.4 V DC) 30 mA (4.75 V DC)	1 A	0.3 A (20.4 to 26.4 V DC) 30 mA (4.75 V DC)	
	0.1 A (other than that above)			0.1 A (20.4 to 26.4 V DC) 15 mA (4.75 V DC)		0.1 A (20.4 to 26.4 V DC) 15 mA (4.75 V DC)	
Common restriction	5 A	5 A	3.2 A/common		5 A	3.2 A/common	
Max. surge current	-	3 A	0.6 A		3 A	0.6 A	
OFF state leakage current	-	1 μA or less				1 μA or less	
ON state voltage drop	-	0.5 V or less				0.5 V or less	
Repose time	OFF→ON	10 ms approx.	0.05 ms or less (at load current 0.5 mA or more)	0.1 ms or less (at load current 1 mA or more)	0.1 ms or less (at load current 2 mA or more)	0.05 ms or less (at load current 0.5 mA or more)	0.1 ms or less (at load current 2 mA or more)
	ON→OFF	8 ms approx.	0.3 ms or less (at load current 0.5 mA or more)	0.3 ms or less (at load current 1 mA or more)	0.3 ms or less (at load current 1 mA or more)	0.3 ms or less (at load current 0.5 mA or more)	0.3 ms or less (at load current 2 mA or more)
Life time	Mechanical life	2 × 10 ⁷ operations or more	-	-	-	-	-
	Electrical life	1 × 10 ⁶ operations or more	-	-	-	-	-
External power supply	Voltage	-	4.75 to 26.4 V DC		4.75 to 26.4 V DC		
	Current (at 24 V)	-	70 mA	110 mA	70 mA/common	70 mA	70 mA
Surge absorber	Snubber circuit (leakage current: 0.2 mA or less)	Zener diode				Zener diode	
Short circuit protection	-	-				-	
Output points per common	16 points/common	16 points/common	32 points/common		16 points/common	32 points/common	
External connection method	Terminal block (M3 terminal screws)	Terminal block (M3 terminal screws)	Connector (MIL-compliant 40 pins)	Connector (MIL-compliant 40 pins, two use)	Terminal block (M3 terminal screws)	Connector (MIL-compliant 40 pins)	

Output specifications

Item	Transistor output units		I/O mixed unit (output side)
	Source type (PNP open collector)		
	32 points type	64 points type	32 points type
Insulation method	Photocoupler		
Output type	Open collector		
Rated load voltage	5 to 24 V DC		
Load voltage allowable range	4.75 to 26.4 V DC		
Max. load current	0.3 A (Y0 to Y7) 0.1 A (other than that above)	0.3 A (26.4 to 20.4 V DC) 30 mA (4.75 V DC)	0.3 A (20.4 to 26.4 V DC) 30 mA (4.75 V DC) 0.1 A (20.4 to 26.4 V DC) 15 mA (4.75 V DC)
Common restriction	3.2 A/common		
Max. surge current	0.6 A		
OFF state leakage current	1 μA or less		

Item	Transistor output units		I/O mixed unit (output side)
	Source type (PNP open collector)		
	32 points type	64 points type	32 points type
ON state maximum voltage drop	0.5 V or less		
Repose time	OFF→ON	0.1 ms or less (at load current 2 mA or more)	
	ON→OFF	0.5 ms or less (at load current 2 mA or more)	
External power supply	Voltage		
	Current (at 24 V)	130 mA	90 mA/common 90 mA
Surge absorber	Zener diode		
Short circuit protection	-		
Output points per common	32 points/common		
Operating mode indicator	32 points LED display (lights when ON)	32 points LED display (lights when ON, selectable by switch)	
External connection method	Connector (MIL-compliant 40 pins)	Connector (MIL-compliant 40 pins, two use)	Connector (MIL-compliant 40 pins, one use)

I/O circuit diagrams

- DC input unit [input circuit diagrams] [16 points]

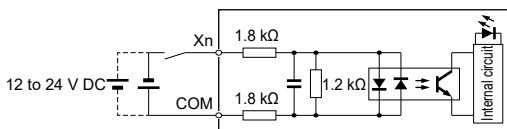

[32 points / 64 points]

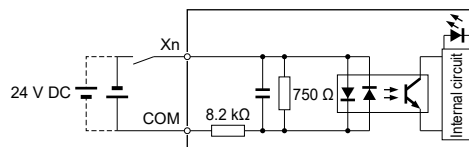

- Limitations on simultaneous ON points [64 points]

Reduce simultaneous ON points according to the graph below.

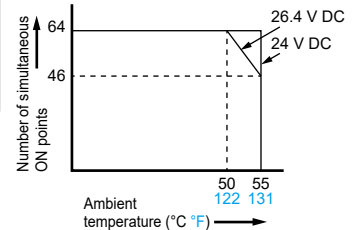

- Relay output unit [output circuit diagram]

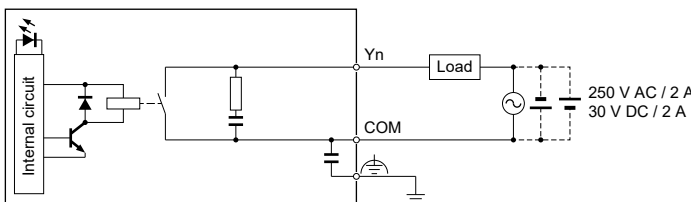

- Limitations on power supply voltage

Reduce power supply voltage according to the graph below by the ambient temperature.

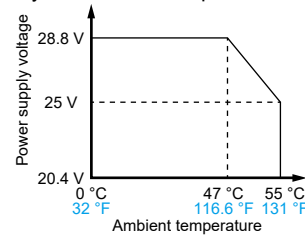

- Transistor output unit [output circuit diagram] [Sink type, 16 points]

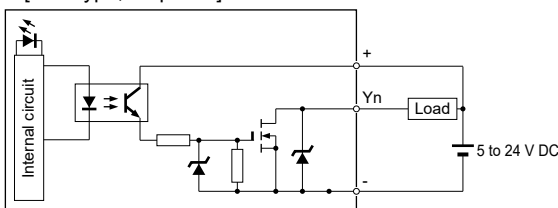

[Sink type, 32 points / 64 points]

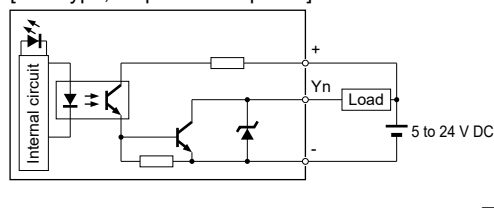

[Source type, 16 points]

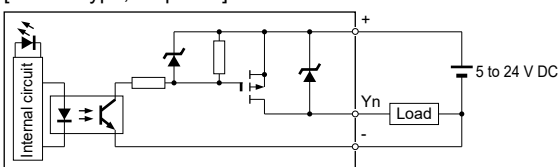

[Source type, 32 points / 64 points]

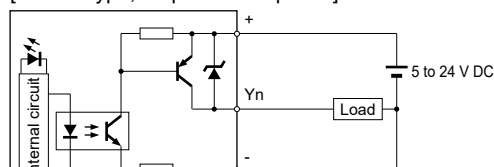

- Limitations on simultaneous ON points [64 points]

Reduce simultaneous ON points of output according to the graph below.

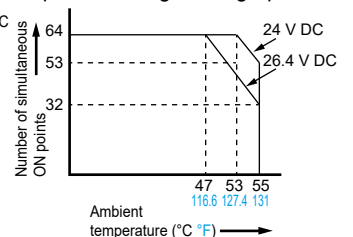

Reduce load current according to the graph below by the external power supply voltage.

[32 points]

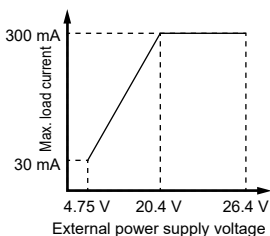

[64 points]

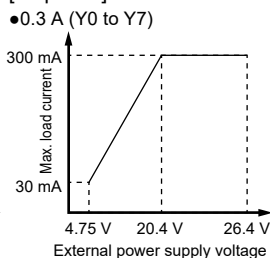

•0.1 A (except Y0 to Y7)

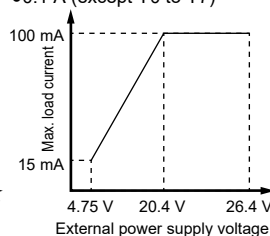

I/O circuit diagrams

I/O mixed unit [I/O circuit diagram]

[Input circuit, sink type]

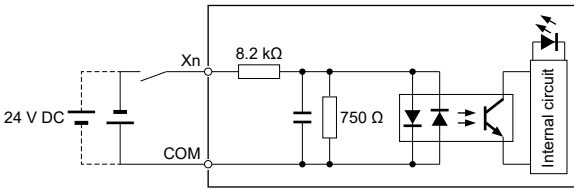

[Output circuit, sink type]

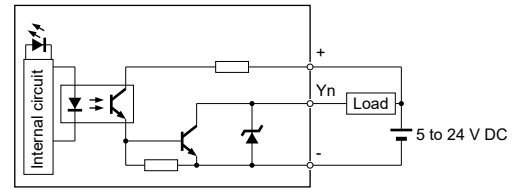

Limitations on simultaneous ON points

(common to input and output)

Reduce simultaneous ON points of input and output according to the graph below.

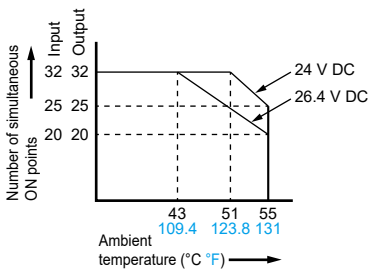

Reduce load current according to the graph below by the external power supply voltage.

• 0.3 A (Y0 to Y7)

• 0.1 A (except Y0 to Y7)

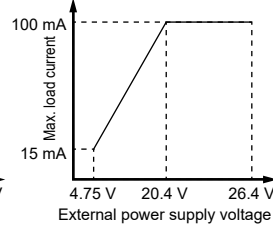
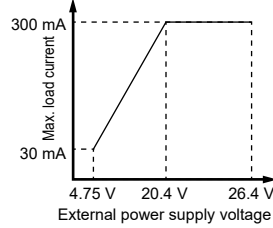

[Input circuit, source type]

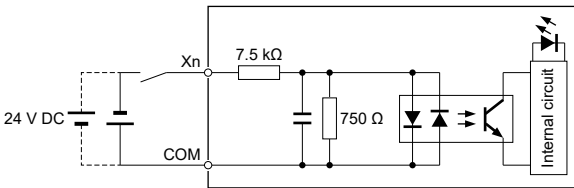

[Output circuit, source type]

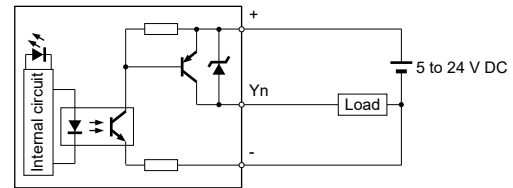

Limitations on simultaneous ON points

(common to input and output)

Reduce simultaneous ON points of input and output according to the graph below.

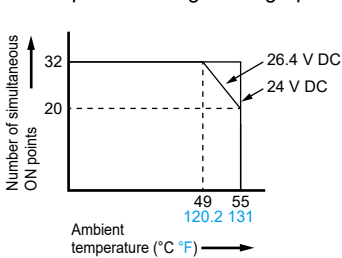

Reduce load current according to the graph below by the external power supply voltage.

• 0.3 A (Y0 to Y7)

• 0.1 A (except Y0 to Y7)

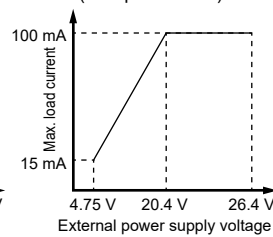
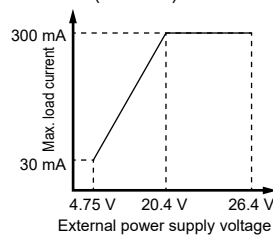

Analog input and output units



Channel insulation is switchable to support various devices

- 20 times faster conversion than in previous model: 25 μ s/channel
- High-speed sampling that doesn't depend on CPU unit scanning
Sampling and data collection in the analog unit!
Use the measurement applications because with the fixed cycle, analog signal can be held in the buffer.

Dependent on scan of CPU unit

The scan gets delayed when the CPU unit slows down due to other processes and sampling becomes sporadic.

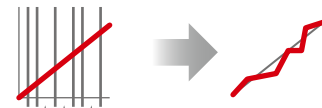

Occurrence of failure

Sampling in the analog unit

Accurate sampling possible with fixed cycle.

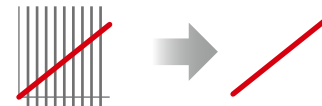

- High-accuracy of $\pm 0.05\%$ F.S. (at $+25^\circ\text{C}$ $+77^\circ\text{F}$) can be achieved.
- Noise-resistant with isolated channels

■ Analog input specifications (AFP7AD4H / AFP7AD8)

Item	Part No.		AFP7AD4H	AFP7AD8
	Number of channels		4 channels	8 channels
Input range (Resolution, Max. 16 bits)	Voltage (Note 1)	-10 to +10 V (resolution: 1/62,500) 0 to 10 V (resolution: 1/31,250) 0 to 5 V (resolution: 1/31,250) 1 to 5 V (resolution: 1/25,000) (Note 2)		
		Current	0 to 20 mA (resolution: 1/31,250) 4 to 20 mA (resolution: 1/25,000) (Note 2)	
Conversion speed	Voltage / current		25 μ s/channel (at non-insulated channels) 5 ms/channel (at insulated channels)	25 μ s/channel (at non-insulated channels)
		Overall accuracy	$\pm 0.05\%$ F.S. or less (at $+25^\circ\text{C}$ $+77^\circ\text{F}$) $\pm 0.1\%$ F.S. or less (at 0 to $+55^\circ\text{C}$ $+131^\circ\text{F}$)	$\pm 0.1\%$ F.S. or less (at $+25^\circ\text{C}$ $+77^\circ\text{F}$) $\pm 0.3\%$ F.S. or less (at 0 to $+55^\circ\text{C}$ $+131^\circ\text{F}$)
Input impedance	Voltage input / Current input	1 M Ω approx. / 250 Ω		
Max. input range	-15 to +15 V voltage input -2 to +30 mA current input			
Insulation method	Between input terminals and internal circuit	Photocoupler and isolated DC / DC converter		
	Between channels	PhotoMOS relay		
Digital processing	Averaging	Number of times	Setting range: 2 to 60,000 times	
		Time duration	Time setting range: 1 to 1,500 ms (at non-insulated channels), 200 to 60,000 ms (at insulated channels)	Time setting range: 1 to 1,500 ms (at non-insulated channels)
	Moving	Range setting: 2 to 2,000 times		
	Scale conversion setting	Any value within $\pm 30,000$		
	Offset setting	Any value within $\pm 3,000$		
Gain setting	Any value within 9,000 to 11,000			
Input range change method	Selectable per channel			
Conversion execution / non-execution channel setting	Selectable per channel unit			
Max. and min. value holding	Possible to make settings on a channel-by-channel basis			
Comparison of upper and lower limit values	Possible to make settings on a channel-by-channel basis (hysteresis)			
Broken wire detection	When less than 0.7 V / 2.8 mA (only when voltage input range 1 to 5 V or current input range 4 to 20 mA is set.)		When less than 2.8 mA (only when current input range 4 to 20 mA is set.)	
Buffer function	3 trigger types: Soft trigger, External trigger and Input level			

Notes: 1) Please note that the digital converted value corresponding to about 2 V of analog input is stored in the input relay area (WX) for channels which are not connected to input when setting the voltage range with AFP7AD8.
2) The full scale (F.S.) on the accuracy of an analog voltage input range from 1 to 5 V and that of an analog current input range from 4 to 20 mA are 0 to 5 V and 0 to 20 mA, respectively.

Item	Part No.		AFP7AD4H	AFP7AD8
	Number of channels		4 channels	8 channels
Trigger input section	Insulation method	Photocoupler		
	Rated input voltage / Rated input current	24 V DC / 4.5 mA approx. (at 24 V DC)		24 V DC / 12 mA approx. (at 24 V DC)
	Input impedance	5.1 k Ω approx.		2 k Ω approx.
	Operating voltage range	21.6 to 26.4 V DC		
	Min. ON voltage / Min. ON current	19.2 V / 3.5 mA		
	Max. OFF voltage / Max. OFF current	5 V / 1.5 mA		
	Response time	OFF \rightarrow ON	0.2 ms or less	0.1 ms or less
		ON \rightarrow OFF	0.2 ms or less	0.1 ms or less
	Input points per common	2 points/common	1 point/common	
Connection method	Terminal block (M3 terminal screw)			

■ Analog output specifications (AFP7DA4H)

Item		AFP7DA4H
Number of output channels	4 channels	
Output range (Resolution, Max. 16 bits)	Voltage	-10 to +10 V (resolution: 1/62,500) 0 to 10 V (resolution: 1/31,250) 0 to 5 V (resolution: 1/31,250) 1 to 5 V (resolution: 1/25,000)
	Current	0 to 20 mA (resolution: 1/31,250) 4 to 20 mA (resolution: 1/25,000)
Conversion speed	Voltage / current 25 μ s/channel	
Overall accuracy	$\pm 0.1\%$ F.S. or less (at $+25^\circ\text{C}$ $+77^\circ\text{F}$) $\pm 0.3\%$ F.S. or less (at 0 to $+55^\circ\text{C}$ $+131^\circ\text{F}$)	
Output impedance (voltage output)	0.5 Ω or less	
Max. output current (voltage output)	10 mA	
Permissible output load resistance (Current output)	500 Ω or less	
Insulation method	Between the input terminals and internal circuit	Photocoupler and isolated DC / DC converter
	Between channels	Not insulated
Scale conversion setting	Any value within $\pm 30,000$	
Offset and gain function	Offset setting	Any value within $\pm 3,000$
	Gain setting	Any value within 9,000 to 11,000
Output range change method	Selectable per channel	
Conversion execution / non-execution channel setting	Selectable per channel unit	
Upper and lower output limit clip function	Possible to make settings on a channel-by-channel basis	
Analog output holding (in PROG mode)	Present value/any value/not holding	
Connection method	Terminal block (M3 terminal screws)	

Temperature input units



High-speed, high-accuracy and multi-channel input

1. Easy to perform high-accuracy measurement

Equipped with a variety of functions required for temperature measurement
Easy to obtain measurement results

Averaging processing	Number of times, time, moving
Insulation	Channels are insulated from one another and from the internal circuit.
Simple setting	Initial settings can be completed on the configuration screen.

2. Capable of high-speed and high-accuracy temperature input

	High-speed conversion	High-accuracy
Thermocouple multiple analog input unit	5 ms/channel (high-speed mode) 25 ms/channel (normal mode)	±0.1 % F.S. (at +25 °C +77 °F) ±0.3 % F.S. (at 0 to +55 °C +32 to +131 °F)
Resistance temperature detector input unit	25 ms/channel (normal mode)	

3. Multi-channel input

One unit can control the input of up to 8 channels.
With so many channels, the unit eliminates the need to purchase additional units, reducing required space and costs.
The thermocouple multiple analog input unit can also control voltage and current inputs.

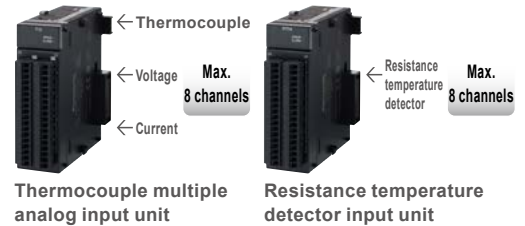

Specifications

Product name		Thermocouple multiple analog input unit
Item	Part No.	AFP7TC8
Number of channels		8 channels
Input range (resolution)	Thermocouple (resolution: 0.1 °C)	K1: -100.0 to 600.0 °C / K2: -200.0 to 1000.0 °C J1: -100.0 to 400.0 °C / J2: -200.0 to 750.0 °C T: -270.0 to 400.0 °C / N: -270.0 to 1300.0 °C R: 0.0 to 1760.0 °C / S: 0.0 to 1760.0 °C B: 0.0 to 1820.0 °C / E: -270.0 to 1000.0 °C PL11: 0.0 to 1390.0 °C / WRe5-26: 0.0 to 2315.0 °C
	Voltage	-10 to 10 V DC (resolution: 1/62,500) 0 to 5 V DC (resolution: 1/31,250) 1 to 5 V DC (resolution: 1/25,000) (Note 1) -100 to 100 mV DC (resolution: 1/62,500) Resolution: max. 16 bits
	Current	0 to 20 mA (resolution: 1/31,250) 4 to 20 mA (resolution: 1/25,000) (Note 1) Resolution: max. 16 bits
Conversion speed		5 ms/channel + 5 ms (Note 2) 25 ms/channel + 25 ms Add the drift compensation measuring time to the number of measuring channels.
Overall accuracy		±0.1 % F.S. or less (at +25 °C +77 °F) ±0.3 % F.S. or less (at 0 to +55 °C +32 to +131 °F)
Reference contact compensation accuracy		±1.0 °C (with thermocouple input)
Input impedance	Voltage / current	1 MΩ / 250 Ω
Insulation method	Between input terminals and internal circuit	Photocoupler and isolated DC / DC converter
	Between channels	PhotoMOS relay
Conversion execution / non-execution channel setting		Selectable per channel unit
Input range change method		Selectable per channel
Digital processing	Averaging	Number of times, time, moving
	Scale conversion setting	Any value within ±30,000 (Voltage and current range only)
	Offset setting	Any value within ±3,000
	Gain setting	±10 %
Comparison of upper and lower limit values		Possible to make settings on a channel-by-channel basis.
Max. and min. value holding		Possible to make settings on a channel-by-channel basis.
Broken wire detection		Available
Connection method		Connector type terminal block

Notes: 1) The full scale (F.S.) ranges of accuracy are 1 to 5 V DC for voltage and 0 to 20 mA for current input, respectively.
2) The AC noise removal is disabled.

Product name		Resistance temperature detector input unit
Item	Part No.	AFP7RTD8
Number of channels		8 channels
Input range (resolution)	Resistance temperature detector (resolution: 0.1 °C)	Pt100 (1): -100.0 to 200.0 °C Pt100 (2): -200.0 to 650.0 °C JPt100(1): -100.0 to 200.0 °C JPt100(2): -200.0 to 650.0 °C Pt1000: -100.0 to 100.0 °C
Conversion speed		25 ms/channel + 25 ms Add the drift compensation measuring time to the number of measuring channels.
Overall accuracy		±0.1 % F.S. or less (at +25 °C +77 °F) ±0.3 % F.S. or less (at 0 to +55 °C +32 to +131 °F)
Allowable signal source resistance		R.T.D. input: 30 Ω (three wires balanced)
Insulation method	Between input terminals and internal circuit	Photocoupler and isolated DC / DC converter
	Between channels	PhotoMOS relay
Conversion execution / non-execution channel setting		Selectable per channel unit
Input range change method		Selectable per channel
Digital processing	Averaging	Number of times, time, moving
	Offset setting	Any value within ±3,000
	Gain setting	±10 %
	Comparison of upper and lower limit values	
Max. and min. value holding		Possible to make settings on a channel-by-channel basis.
Broken wire detection		Available
Connection method		Connector type terminal block

High-speed counter units

One of the fastest in industry added in lineup



1. Industry-leading class speed of 16 Mpps (for differential input and 2-phase, 4-multiple)

Accurate, real-time surveillance of inverter and motor rotation speed variation.

2. Supports 5 / 12 / 24 V DC and differential input.

Supports wide range of interface from 12 to 24 V DC, 5 V DC and differential input with one unit.

3. Powerful application support

Input pulse string frequency (period) can be measured inside the unit with built-in periodical pulse counter function. Built-in ring counter function can easily detect index table position. Line speed adjustment and work length measurement are available with built-in clock that allows accurate time measurement.

4. Various functions can be used without a ladder program

Capture function of count value	Finite difference calculation of capture value	Interrupt using comparison match
Comparison match and band comparison	Measurement of frequency and number of revolution	Reset of Z number and preset
Reset and preset of external signal	Built-in clock selection	

Specifications

Item	Type	2 channels type	4 channels type	
	Part No.	AFP7HSC2T	AFP7HSC4T	
Input	Insulation method	Photocoupler		
	Rated input voltage	12 to 24 V DC / 3.5 to 5 V DC		
	Input impedance	24 V DC / 5 V DC	3.0 kΩ approx. / 390 Ω approx.	
	Usage voltage range	24 V DC / 5 V DC	10.8 to 26.4 V DC / 3.5 to 5.25 V DC	
	Min. ON voltage / Min. ON current	24 V DC / 5 V DC	10 V DC / 4 mA / 3.0 V DC / 4 mA	
	Min. OFF voltage / Min. OFF current	24 V DC / 5 V DC	2.0 V DC / 2 mA / 1.0 V DC / 0.5 mA	
	Input time constant setting		None, 0.1 μs, 0.2 μs, 0.5 μs, 1.0 μs, 2.0 μs and 10.0 μs	
	Number of counters		2 channels	4 channels
Count function	Counter type	Linear counter / Ring counter		
	Counting range	Signed 32-bit (-2,147,483,648 to +2,147,483,647)		
	Max. input frequency	4 MHz / 8 MHz for individual input (phases A and B) (Duty ratio 50 ±10 %) 4 MHz / 8 MHz for direction discrimination input (Duty ratio 50 ±10 %) 4 MHz / 8 MHz / 16 MHz for 2-phase input (Duty ratio 50 ±10 %, Phase shifting below 5 %)		
	Input signal	Phases A, B and Z		
	External I/O	Control signal input: 4 points (2 points/ch) External output: 4 points (2 points/ch)	Control signal input: 8 points (2 points/ch) External output: 8 points (2 points/ch)	
	Counter input type	Individual input: 1 multiple, 2-multiple Direction discrimination input: 1 multiple, 2-multiple 2-phase input: 1 multiple, 2-multiple, 4-multiple		
Measurement function	Frequency measurement function	Measures the intervals between the variations of count values, and calculates the frequency.		
Comparison function	Target value match function	Depending on the count direction, sets or resets the output when the counter value reaches the target value.		
External output	Comparison result output function	Outputs the result of comparison function.		
Other functions	Capture function	Acquires the current count value from the edges of input signals, and stores it in the capture 0 register or capture 1 register. The value of the specified capture register will be overwritten by a new value and the old value will be discarded every time a counter value is captured.		
	Interrupt input function	Available (2 points/ch, Max. 8 points/unit) ^(Note 1, 2)		

Notes: 1) The interrupt input function can be used for 8 points per unit and for a maximum of 8 units (max. 64 points) in the whole system. However, the entire scan time slows down as more interrupt programs are used. Minimize the use of interrupt programs.

2) The priority order for interrupt inputs is as follows; In a unit, from the smallest interrupt bit. In the whole system, from the smallest unit number.

Positioning units

Combined multi-axe control can be achieved at reduced cost.



1. Equipped with electronic cam and electronic gear functions

Ladder program is capable of controlling electronic cams and gears. Virtual axes are supported and operable without connecting to external encoders.

2. Organized wiring to servo amplifier

A servo ON output terminal is provided that allows simple and neat wiring to the servo amplifier. Also, wiring from the I/O unit is unnecessary, and a test run is possible by only a positioning soft tool.

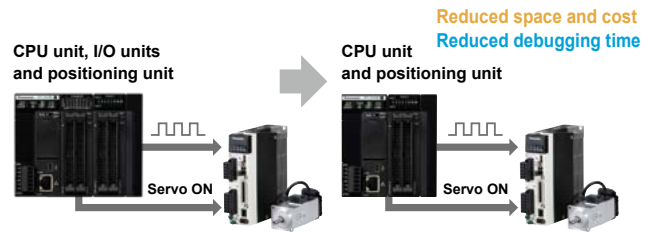

3. Dedicated configuration tool

Start positioning dedicated configuration tool using **Control FWIN GR7**. Parameter and positioning operation settings can be made easily.

Test operation is also supported. Positioning operations can be checked even-while the CPU unit is in program mode.



Performance specifications

Item	Specifications				
	2 axes type		4 axes type		
Part No.	AFP7PP02T	AFP7PP02L	AFP7PP04T	AFP7PP04L	
Output type	Transistor	Line driver	Transistor	Line driver	
Max. operation speed	500 kpps	4 Mpps	500 kpps	4 Mpps	
Number of axes controlled	2 axes		4 axes		
Interpolation control	2 axes linear interpolation, 2 axes circular interpolation		2 axes linear interpolation, 3 axes linear interpolation, 2 axes circular interpolation, 3 axes spiral interpolation		
Position command units	pulse μm (The minimum command unit can be selected from 0.1 μm or 1 μm.) inch (The minimum command unit can be selected from 0.00001 inch or 0.0001 inch.) degree (The minimum command unit can be selected from 0.1 degree or 1 degree.)				
Position command range	pulse: -1,073,741,823 to +1,073,741,823 pulse μm (0.1 μm): -107,374,182.3 to +107,374,182.3 μm μm (1 μm): -1,073,741,823 to +1,073,741,823 μm inch (0.00001 inch): -10,737,418.23 to +10,737,418.23 inch inch (0.0001 inch): -107,374,182.3 to +107,374,182.3 inch degree (0.1 degree): -107,374,182.3 to +107,374,182.3 degree degree (1 degree): -1,073,741,823 to +1,073,741,823 degree				
Speed command range	pulse: 1 to 32,767,000 pps μm: 1 to 32,767,000 μm/sec. inch: 0.001 to 32,767,000 inch/sec. degree: 0.001 to 32,767,000 rev/sec. *Specify an output speed that is below the maximum operating speed.				
Automatic operation	Position control	Position command method	Absolute (Absolute position designation), Increment (Relative position designation)		
		Acceleration / deceleration method	Linear acceleration / deceleration, S-curve acceleration / deceleration		
		Acceleration time	0 to 10,000 ms (in increments of 1 ms)		
		Deceleration time	0 to 10,000 ms (in increments of 1 ms)		
		Number of positioning tables per axis	Standard area: 600 points, expansion area: 25 points		
	Control method	Independent	PTP control (E point control, C point control), CP control (P point control), Speed control (J point control)		
		2-axis interpolation	Linear	E point, P point and C point controls: Specify synthesis speed or major axis speed	
			Circular	E point, P point and C point controls: center point or passing point	
		3-axis interpolation	Linear	E point, P point and C point controls: Specify synthesis speed or major axis speed	
	Spiral		E point, P point and C point controls: center point or passing point		
Startup time	Standard area: 3 ms or less, expansion area: 5 ms or less				
Other function	Dwell time	0 to 32,767 ms (in increments of 1 ms)			

Item	Specifications			
	2 axes type		4 axes type	
Part No.	AFP7PP02T	AFP7PP02L	AFP7PP04T	AFP7PP04L
Manual operation	JOG operation	Acceleration / deceleration method	Linear acceleration / deceleration, S-curve acceleration / deceleration	
		Acceleration / deceleration time	0 to 10,000 ms (in increments of 1 ms)	
	Home return	Acceleration / deceleration method	Linear acceleration / deceleration	
		Acceleration / deceleration time	0 to 10,000 ms (in increments of 1 ms)	
Pulser operation	Return methods	7 methods: DOG method (3 types), Limit method (2 types), Data set method, Z-phase method		
	Speed command range	Operates in synchronization with pulser input		
Stop function	Deceleration stop	Deceleration time	Deceleration time of running operation	
	Emergency stop	Deceleration time	0 to 10,000 ms (in increments of 1 ms)	
	Limit stop	Deceleration time	0 to 10,000 ms (in increments of 1 ms)	
	Error stop	Deceleration time	0 to 10,000 ms (in increments of 1 ms)	
Synchronous operation function	System stop	Deceleration time	Immediate stop (0 ms), all axes stop	
	Synchronous basic setting	Master axis	Existing axes, virtual axes or pulse input (1 to 4)	
Electronic gear function		Slave axis	Max. 2 axes	Max. 4 axes
	Electronic clutch function	Operation setting	Gear ratio setting	
Electronic cam function		Operation method	Direct method, Acceleration / deceleration method	
	Synchronous cam function	Clutch ON trigger	Contact input	
Other specifications		Clutch method	Direct method, Linear slip method	
	Output mode	Cam curve	Select from 20 types Multiple curves can be specified within a phase (0 to 100%).	
High-speed counter function (Note)		Resolution	1024, 2048, 4096, 8192, 16384, 32768	
	Built-in servo ON output	Number of cam patterns	4 to 16 (Depends on resolution)	
Input mode		Countable range	-1,073,741,823 to +1,073,741,823 pulse	
	Input mode	Phase difference input, Direction distinction input, Individual input (transfer multiple available for each)		

Note: Pulser input and high-speed counter functions cannot be used simultaneously, as the same pulse input terminal is used.

Pulse output units

Super high-speed positioning control achieved



1. High-speed startup

The pulse output request is received from the CPU unit and the startup speed up to output of the pulse is super high-speed of 1 μ s. Tact time is reduced with repeat of short-distance positioning operations, etc.

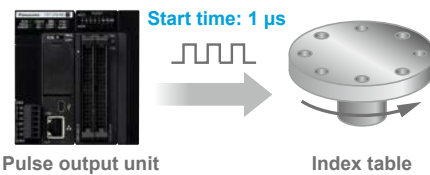

2. Neater wiring to servo and amplifier

Equipped with a servo ON output terminal, wiring to the servo amplifier is neater.

3. Replacement from FP2 series is easy

Usage is same as the previous **FP2** positioning unit (multi-function type). Program transfer is easy.

Performance specifications

Item		AFP7PG02T	AFP7PG04T	AFP7PG02L	AFP7PG04L
Output type		Transistor		Line driver	
Occupied points		Each 32 points of I/O	Each 64 points of I/O	Each 32 points of I/O	Each 64 points of I/O
Number of axes controlled		2 axes, independent	4 axes, independent	2 axes, independent	4 axes, independent
Position command	Command units	Pulse (The program specifies whether increment or absolute is used.)			
	Max. pulse count	Signed 32 bits (+2,147,483,647 to -2,147,483,648 pulses)			
Speed command	Command range	1 pps to 500 kpps (can set in 1 pps)		1 pps to 4 Mpps (can set in 1 pps)	
Acceleration/ deceleration command	Acceleration/ deceleration	Linear acceleration / deceleration, S acceleration / deceleration			
	"S" Acceleration/ deceleration	Can select from sin curve, secondary curve, cycloid curve and third curve.			
Home return	Acceleration/ deceleration time	0 to 32,767 ms (can set in 1 ms)			
	Home return speed	Speed setting possible (changes return speed and search speed)			
Home return	Input signal	Home input, near home input, limit input (+), limit input (-)			
	Output signal	Deviation counter clear signal			
Operation mode		E point control (linear and S acceleration/ decelerations) P point control (linear and S acceleration/ decelerations) Home return operation (home search) JOG operation ^(Note 1) JOG positioning operation Pulsar input function ^(Note 2) transfer multiplication ratio ($\times 1, \times 2, \times 5, \times 10, \times 50, \times 100, \times 500, \times 1000$) Real-time frequency change Infinity output			
Startup time		0.02 ms, 0.005 ms or 0.001 ms selecting possible ^(Note 3)			
Output interface	Output mode	1 pulse output (pulse and sign), 2 pulse output (CW and CCW)			
High-speed counter function ^(Note 2)	Countable range	Signed 32 bits (+2,147,483,647 to -2,147,483,648 pulse)			
	Input mode	Two-phase input, direction distinction input, individual input (with multiplier function mode)			
Other functions		Startup using I/O contact Built-in limit (+) and limit (-) With servo ON output			
External power supply	Voltage	21.6 to 26.4 V DC			
	Current	50 mA (at 24 V)	90 mA (at 24 V)	50 mA (at 24 V)	90 mA (at 24 V)

Notes: 1) When linear acceleration/ deceleration operation is selected, it is possible to change the target speed during operation.

2) Since the pulsar input function and the high-speed counter function use the same pulse input terminal, both functions cannot be used at the same time.

3) Startup time can be changed using the common memory control code setting. The factory (default) setting is 0.02 ms. Startup time is defined as the time between startup and output of the first pulse.

Motion control units EtherCAT® type*

*EtherCAT is registered trademark and patented technology, licensed by Beckhoff Automation GmbH, Germany.



AFP7MC16EC AFP7MC32EC AFP7MC64EC
* Settings require a Control Motion Integrator key unit AFP5MTKEY (sold separately).

Motion control of up to axes in one unit

A single FP7 motion control unit can control 64 axes of MINAS A6B and 32 virtual axes. It is now easier to perform multiple axial control.



- Industry's fastest class with 0.5 ms* transmission cycle
- Control system: Cyclic position control
- Positioning table: 1,000 tables/axis

*4 axes (2-axis interpolation × 2 groups). Our company created send/receive allocation.

Item	Transmission cycle		
	16 axes	32 axes	64 axes
Independent axis control	1ms	2ms	4ms
Interpolation control			
Synchronous control			

*The transmission cycle has changed from firmware Ver. 1.2.

Specifications

Item	16 axes type	32 axes type	64 axes type	
Connected slave (Note 1, 2, 3)	Panasonic AC servo motor MINAS A6B / A5B series EtherCAT-compatible S-LINK V gateway controller SL-VGU1-EC			
Number of control axes	Real axis: 16 axes Virtual axis: 8 axes	Real axis: 32 axes Virtual axis: 16 axes	Real axis: 64 axes Virtual axis: 32 axes	
Communication cycle	0.5 ms / 1 ms / 2 ms / 4 ms			
Interpolation control	2-axis linear interpolation, 2-axis circular interpolation, 3-axis linear interpolation and 3-axis spiral interpolation			
Number of occupied I/O points	Input: 16 points, Output: 16 points			
Automatic operation Positioning control (OSP)	Position specification method	Absolute (specified absolute position), Increment (specified relative position)		
	Position specified unit	pulse µm (select a minimum instruction unit of 0.1 µm or 1 µm) inch (select a minimum instruction unit of 0.00001 inch or 0.0001 inch) degree (select a minimum instruction unit of 0.1 degree or 1 degree)		
	Position reference range	pulse: -2,147,483,648 to 2,147,483,647 pulse µm (0.1 µm): -214,748,364.8 to 214,748,364.7 µm µm (1 µm): -2,147,483,648 to 2,147,483,647 µm inch (0.00001 inch): -21,474,836.48 to 21,474,836.47 inch inch (0.0001 inch): -214,748,364.8 to 214,748,364.7 inch degree (0.1 degree): -214,748,364.8 to 214,748,364.7 degree degree (1 degree): -2,147,483,648 to 2,147,483,647 degree		
	Speed reference range	pulse: 1 to 2,147,483,647 pps µm: 1 to 2,147,483,647 µm/sec. inch: 0.001 to 2,147,483,647 inch/sec. degree: 0.001 to 2,147,483,647 rev/sec.		
	Acceleration / deceleration type	Linear acceleration / deceleration, S-shaped acceleration / deceleration		
	Acceleration / deceleration time	0 to 10,000 ms (adjustable in 1 ms increments)		
	Number of positioning tables	Each axis standard area: 1,000 points expansion area 100 points (24 axes in case of using simultaneous startup)		
	Control method	Independent	PTP control (E point control, C point control), CP control (P point control), Speed control (J point control)	
		2-axis interpolation	Linear interpolation	E point, P point and C point controls: Specify synthesis speed or major axis speed
			Circular interpolation	E point, P point and C point controls: Center point or passing point
3-axis interpolation		Linear interpolation	E point, P point and C point controls: Specify synthesis speed or major axis speed	
		Spiral interpolation	E point, P point and C point controls: Center point or passing point	
Other function	Dwell time	0 to 32,767 ms (adjustable in 1 ms increments)		

Notes: 1) A6B and SL-VGU1-EC are compatible with the FP7 motion control unit Ver.1.2 or later.

2) One unit or more A6B or A5B must exist on the network.
Also, A6B and A5B can both be used on the network.

3) The hub for EtherCAT / Ethernet cannot be used.

Item	16 axes type	32 axes type	64 axes type	
Manual operation	JOG / inching operation	Speed reference range	pulse: 1 to 2,147,483,647 pps µm: 1 to 2,147,483,647 µm/sec. inch: 0.001 to 2,147,483,647 inch/sec. degree: 0.001 to 2,147,483,647 rev/sec.	
		Acceleration / deceleration type	Linear acceleration / deceleration, S-shaped acceleration / deceleration	
		Acceleration / deceleration time	0 to 10,000 ms (adjustable in 1 ms increments)	
	Home return	Speed reference range	pulse: 1 to 2,147,483,647 pps µm: 1 to 2,147,483,647 µm/sec. inch: 0.001 to 2,147,483,647 inch/sec. degree: 0.001 to 2,147,483,647 rev/sec.	
		Acceleration / deceleration type	Linear acceleration / deceleration, S-shaped acceleration / deceleration	
		Acceleration / deceleration time	0 to 10,000 ms (adjustable in 1 ms increments)	
Return methods	DOG method (4 types), Limit method (2 types), Data set method, Z phase method, Stop-on-contact method (2 types)			
Stop function	Deceleration stop	Deceleration time	Axis operation mode startup time of activated axis	
	Emergency stop	Deceleration time	0 to 10,000 ms (adjustable in 1 ms increments)	
	Limit stop	Deceleration time	0 to 10,000 ms (adjustable in 1 ms increments)	
	Error stop	Deceleration time	0 to 10,000 ms (adjustable in 1 ms increments)	
System stop	Deceleration time	Immediate stop (1 ms), all axes stop		
Synchronous operation function	Synchronous basic setting	Master axis	Selection possible of real axis and virtual axis	
		Slave axis	Virtual axis: Max. 8 axes/master Virtual axis: Max. 16 axes/master Virtual axis: Max. 32 axes/master	
	Electronic gear function	Operation setting	Gear ratio setting	
	Electronic clutch function	Operation method	Direct method, Acceleration / deceleration method	
		Clutch ON trigger	Contact input	
	Clutch method	Direct method, Linear slide method		
Electronic cam function	Cam curve	Select from 20 types Multiple curves can be specified within a phase (0 to 100 %).		
	Resolution	1,024, 2,048, 4,096, 8,192, 16,384, 32,768		
	Number of cam patterns	16 to 64 (Depends on resolution)	32 to 128 (Depends on resolution)	64 to 256 (Depends on resolution)
Other specifications	Software limit function	Set range	pulse: -2,147,483,648 to 2,147,483,647 pulse µm (0.1 µm): -214,748,364.8 to 214,748,364.7 µm µm (1 µm): -2,147,483,648 to 2,147,483,647 µm inch (0.00001 inch): -21,474,836.48 to 21,474,836.47 inch inch (0.0001 inch): -214,748,364.8 to 214,748,364.7 inch degree (0.1 degree): -214,748,364.8 to 214,748,364.7 degree degree (1 degree): -2,147,483,648 to 2,147,483,647 degree	
		Torque judgment	Torque judgment Selection possible of active / non-active and error / warning 0.0 to ±500.0 %	
	Monitor judgment	Actual speed judgment	Actual speed judgment Selection possible of active / non-active and error / warning 0.0 to ±5,000 rpm	
Backup	Parameters and positioning data are saved to flash memory (battery free)			
Limit input CWL, CCWL monitor and proximity (DOG) monitor General-purpose input: 5 points, General-purpose output: 1 point (I/O from AMP) Auxiliary output contact and auxiliary output cord				

Multi input/output units

Multifunctional control achieved in one unit !



Accomplish highly functional control at the best price.

Highly functional control is possible using with best value model CPU unit **AFP7CPS2R**.

Settings executed with FPWIN GR7

Unit settings easily performed using configuration screen.

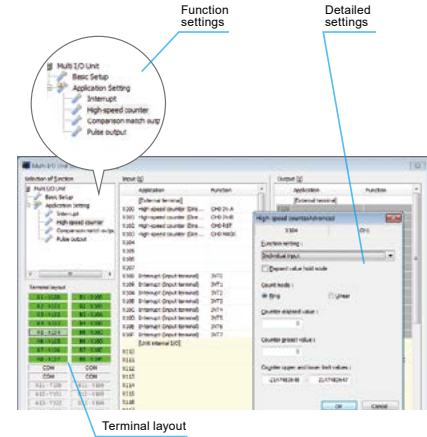

Function specifications (AFP7MXY32DWD)

Item		AFP7MXY32DWD	
Basic input and output	Number of occupied I/O points	Input / Output: 64 points each (4 words)	
	Number of external I/O points	Input: 16 points, Output: 16 points	
	Input time constant setting	None, 0.5 μ s, 1 μ s, 2 μ s, 4 μ s, 8 μ s, 16 μ s, 32 μ s, 64 μ s, 96 μ s, 128 μ s, 256 μ s, 2 ms, 4 ms or 8 ms Setting possible in 2-point units	
	Output polarity setting	No output, N channel, P channel, both channels (push pull output), and differential output Setting possible in 4-point units	
Interrupt	Number of points	8 points/unit (Max. of 8 units can be used with FP7 system when setting interrupt mode.)	
	Mode	Non-interrupt unit, interrupt unit (Set using DIP switches)	
	Interrupt condition setting	Terminal input, Comparison match	
Counter	Counter type	Ring counter, Linear counter	
	Input mode	Direction discrimination, individual input, phase input	
	Number of channels	4 channels (Note 1)	
	Counting range	Signed 32-bit (-2,147,483,648 to +2,174,483,647) Setting possible of upper and lower limits	
	Max. countable speed	5 V input voltage: 500 kHz (Note 2) 12 V input voltage: 500 kHz (350 kHz with phase input) (Note 2) 24 V input voltage: 250 kHz (180 kHz with phase input) (Note 2)	
	Min. input pulse width	0.5 μ s	
	Comparison output setting	Max. 8 points Terminal input counter: 4 channels	
	Others	Transfer multiplication function ($\times 1, \times 2, \times 4$) Elapsed value offset / preset function Elapsed value hold function, setting of upper / lower count limits Input pulse frequency measurement Overflow / underflow detection	
Pulse output	Number of channels	4 channels	
	Output mode	Direction discrimination, individual input, phase input, comparison match stop	
	Output terminals	Pulse output function	2 terminals/channel (B11 to B18 terminals)
		PWM output function	1 terminal/channel (B11, B13, B15 and B17 terminals)
	Output frequency	Pulse output function	1 to 500 kHz (Note 3) (1 Hz increments)
		PWM output function	1 to 100 kHz (Note 3) (1 Hz increments)
Duty	Pulse output function	50 % approx. (fixed)	
	PWM output function	0 to 100 % [Set in 0.1% increments (Note 4)]	
Other functions	Pulse number measurement function (dedicated pulse counter 4 channels)		

Notes: 1) When using elapsed value hold function, number of channels will be limited.
 2) With 50 % duty input pulse.
 3) When push pull setting or output current is 0.1 A. Varies according to load.
 4) Will be set in 1 % increments when output frequency exceeds 10 kHz.

PHLS (remote I/O) units

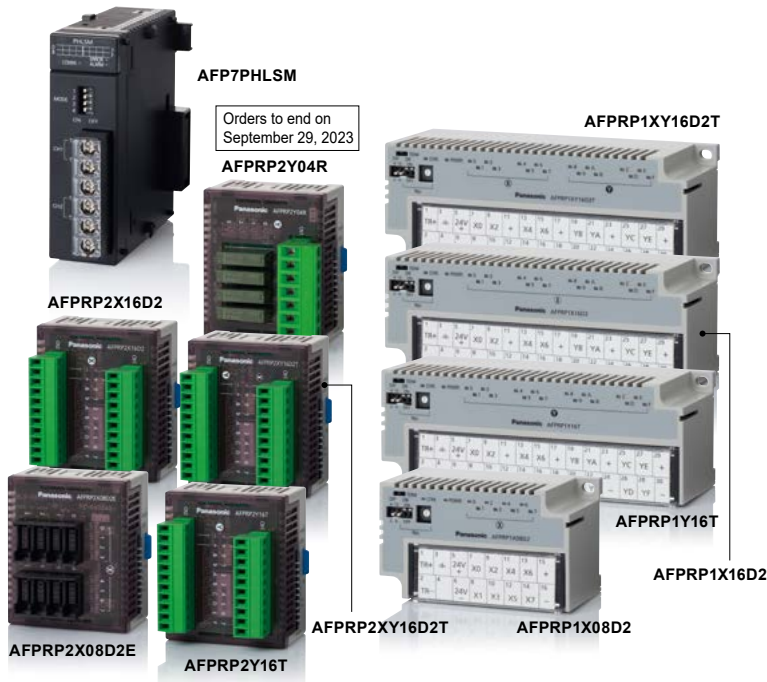

Speedy, resistant to noise Remote I/O Line up

1. High speed communication

A 12 Mbps maximum transmission speed can be selected. Fast response at update cycle of 1,000 points/2 ms can be achieved.

2. High resistance to noise

Data can be transferred accurately, even in inadequate wiring environments.

3. Various types of compact slave units

Compact slave units (60 × 70 × 40 mm $2.36 \times 2.76 \times 1.57$ in) are smaller than common screw terminal types and are lined up to contribute to space savings. A wide variety of slave units are available.

Communication specifications (common)

Item	Specifications
Communication method	Two-wire system half duplex
Insulation method	Pulse transformer insulation
Communication speed	6 Mbps / 12 Mbps
Synchronous method	Bit synchronization
Error check	CRC-12
Communication distance	Total length 200 m 656 ft (at 6 Mbps) / 100 m 328 ft (at 12 Mbps) ^(Note)
Connection method	Multi-drop method
Impedance	100 Ω
Terminator	Mounted on unit
External interface	Master unit: terminal block (2 channels) Slave unit (standard type): screw-type terminal block Slave unit (compact type): connector-type terminal block

Note: Performance when the recommended cable is used. Use of the recommended cable is necessary to achieve the maximum transmission distance and number of slave units.

Input side specifications

Item	Specifications	
	Standard type	Compact type
Insulation method	Photocoupler insulation	Non-isolated
Rated input voltage	24 V DC	
Rated input current	3 mA approx.	4.3 mA approx.
Input impedance	7.5 kΩ approx.	5.6 kΩ approx.
Min. ON voltage / Min. ON current	15 V / 2 mA	17 V / 2 mA
Max. OFF voltage / Max. OFF current	5 V / 0.5 mA	
Response time	OFF→ON	1 ms or less
	ON→OFF	1 ms or less

Introduction of remote analog units

Our PHLS (remote I/O) unit complies with HLS (Hi-speed Link System) specification. This product is used when you want to connect analog units from other manufacturers that comply with the HLS specification.

PHLS master unit
AFP7PHLSM

Our product PHLS slave unit

Other companies' analog units compliant with HLS (Hi-speed Link System)

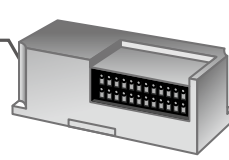

M-System Co., Ltd. R7HL series
DC voltage / current input,
4 points
R7HL-SV4-R/H
DC voltage output, 2 points
R7HL-YV2-R/H

Notes: 1) When using another company's HLS-compliant product, be sure to verify that the units operate correctly with the installed target equipment. Please contact the respective manufacturers for product details.
2) Units other than the analog units shown above can also be connected. The following shows the communication specifications of our PHLS (remote I/O) master unit. Please select a unit that meets the specifications.

Output side specifications (except relay)

Item	Specifications	
	Standard type	Compact type (except relay)
Insulation method	Photocoupler insulation	Non-isolated
Output type	Sink type (Open collector output)	
Rated load voltage	20.4 to 28.8 V DC	
Max. control capacity	0.1 A/point	
Max. surge current	0.5 A	
OFF state leakage current	0.1 mA or less	
ON state maximum voltage drop	0.5 V or less	
Repose time	OFF→ON	0.05 ms or less
	ON→OFF	0.5 ms or less
Surge absorber	Zener diode	
Short circuit protection	None	

Output side specifications (relay)

Item	Specifications	
	Compact type (relay)	
Insulation method	Relay insulation	
Rated control capacity	1 A 250 V AC (2 A/common) 1 A 30 V DC (2 A/common)	
Min. load	0.1 mA 100 mV (resistive load)	
Repose time	OFF→ON	10 ms or less
	ON→OFF	5 ms or less
Life time	Mechanical life	2 × 10 ⁷ operations or more
	Electrical life	1 × 10 ⁵ operations or more (switching frequency: 20 times/minute)
Surge absorber	None	
Short circuit protection	None	

Communication method	Transmission speed	Connection method
Half-duplex communication (incompatible with full-duplex communication)	6 Mbps / 12 Mbps	Terminal block (connection via screw terminal)

I/O circuit diagrams

• Standard type (screw-type terminal block)

[Input type]

AFPRP1X08D2 / AFPRP1X16D2

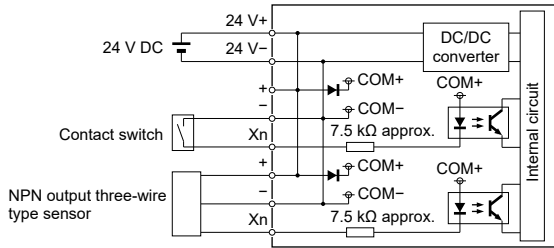

[Output type]

AFPRP1Y16T

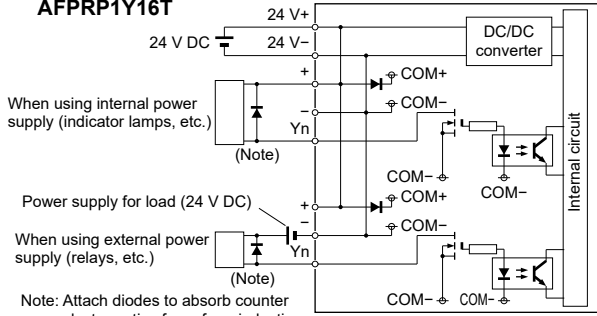

[I/O mixed type]

AFPRP1XY16D2T

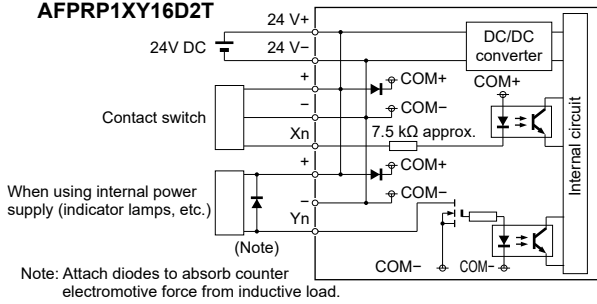

• Compact type (relay output)

AFPRP2Y04R

[When connecting to separated common terminal]

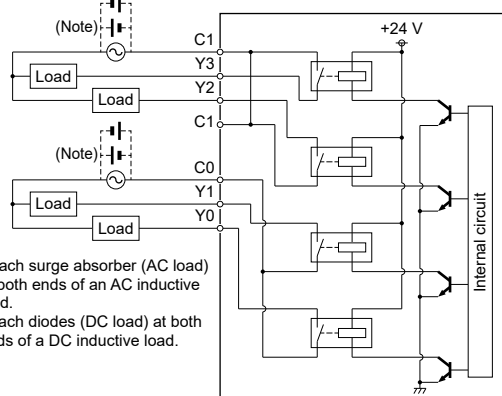

• Compact type (connector-type terminal block)

[Input type]

AFPRP2X16D2

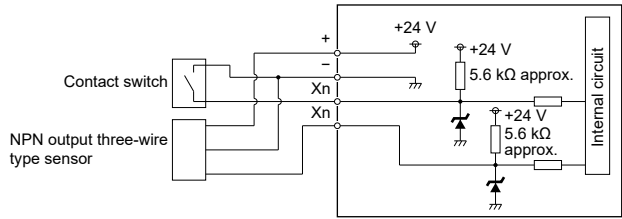

[Output type]

AFPRP2Y16T

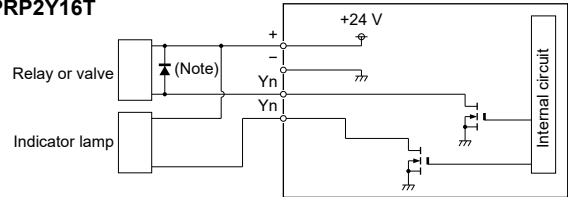

[I/O mixed type]

AFPRP2XY16D2T

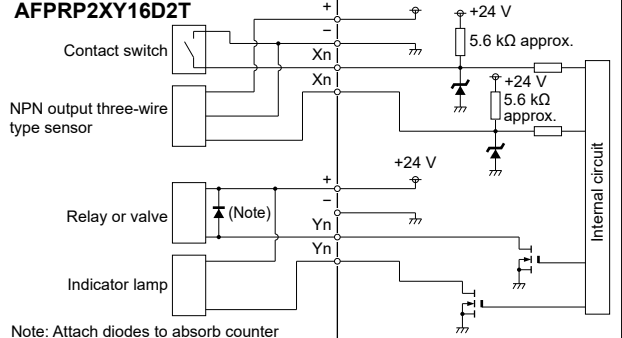

• Compact type (e-CON)

AFPRP2X08D2E

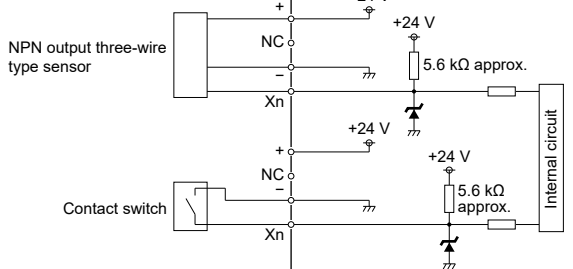

Power supply units



Announce system errors using the built-in external alarm.

1. Equipped with system error alarm contact

Output contact for system error external alarm is provided. If a power supply unit is used concurrently, no additional units are required.

■ Specifications

Item	AFP7PSA1	AFP7PSA2
Rated input voltage		100-240 V AC
Allowable input voltage range		85-264 V AC
Input power supply frequency		47 to 63 Hz
Inrush current		40 A or less (Note 2)
Input current	0.75 A or less	1.25 A or less
Rated output current (at 24 V)	1.0 A	1.8 A
Alarm contact capacity		1 A (30 V DC)
Remaining lifespan counting function	Not available	Available (Note 1)

Notes: 1) Alarm by CPU unit
 2) On cold starting
 3) Power supply unit cannot be used with AFP7CPS2R CPU unit.

Serial communication unit



Lineup of serial communication unit that can be expanded with a serial communication cassette.

1. Two serial communication add-on cassettes can be installed

A total of five types of cassettes can be freely combined in a combination of RS-232C, RS-422 or RS-485. Up to 4 channels can be supported in one unit.

2. High expandability

The number of serial communication channels can be increased by connecting a CPU unit. A CPU unit can be connected to maximum of 8 serial communications units.

Note: To connect serial communication unit, the CPU unit has to have firmware Ver. 1.2 or later, and to be running FPINW GR7 Ver. 1.3 or later.

■ Specifications

Item	AFP7NSCR
Number of communication cassette installations	Max. 2 cassettes
Number of installations to CPU unit	Max. 8 units

Note: Communication cassette AFP7CCRET1 is not supported.

Multi-wire link unit



Presenting the FP7 multi-wire link unit!

Use for additional connection or replacement in existing multi-wire link networks

MEWNET-W2 (PLC link)

FP2 Multi-wire link unit (W2 mode)



FP2 Multi-wire link unit (W2 mode)



I want to use the others as is.

FP2 Multi-wire link unit (W2 mode)



FP7



Twisted-pair cable

MEWNET-F (Remote I/O)

Master station

FP2 Multi-wire link unit (F mode)

Replacement

FP7



Slave station

Twisted-pair cable / VCTF cable

I/O terminal board

I/O terminal unit

I want to use the slave stations as is.

Manifold solenoid valve

Note: Cannot be connected to the FP2 slave unit or FP3 slave unit (discontinued product).

MEWNET-W (PLC link)

FP2 Multi-wire link unit (W mode)

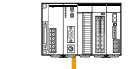

Replacement

FP7



I want to use the others as is.

FP3 + W link unit*

FP10SH + W link unit*

FP2 Multi-wire link unit (W mode)

*Discontinued product

Specifications

Item	AFP7MW		
	W mode	W2 mode	F mode
Mode	W mode	W2 mode	F mode
Communication method	Token bus method		Polling method
Transmission method	Baseband transmission method		
Transmission speed	500 kbits/sec.	500 kbits/sec., 250 kbits/sec.	500 kbits/sec.
Transmission distance	Extendable to 800 m 2,624.672 ft	Extendable to 800 m 2,624.672 ft (500 kbits/sec.) Extendable to 1,200 m 3,937.008 ft (250 kbits/sec.)	Extendable to 700 m 2,296.588 ft
Number of connectable stations	Max. 32 stations		1 master station + Max. 32 slave stations
Transmission error check	CRC (Cyclic Redundancy Check) system		
Synchronous method	Start-stop synchronization		
Interface	RS485 compatible		
Transmission cable	Twisted-pair cable		Twisted-pair cable, VCTF cable
RAS function	Hardware self-diagnosis function		

Note: Some functions of the FP7 are not compatible with conventional products.

General specifications on each units

Common general specifications

Item	Specifications
Ambient temperature	0 to +55 °C +32 to +131 °F, Storage -40 to +70 °C -40 to +158 °F
Ambient humidity	10 to 95 % RH (at +25 °C +77 °F, no condensation), Storage 10 to 95 % RH (at +25 °C +77 °F, no condensation)
Vibration resistance	5 to 8.4 Hz, single amplitude of 3.5 mm 0.138 in, 1 sweep/min. (IEC 61131-2); 8.4 to 150 Hz, constant acceleration of 9.8 m/s ² , 1 sweep/min. (IEC 61131-2), 10 times each in X, Y, and Z directions
Shock resistance	147 m/s ² or more, 3 times each in X, Y, and Z directions (IEC 61131-2)
Noise immunity	1,000 V [p-p] with pulse width 50 ns and 1 μs (using a noise simulator)
Operating condition	Free from corrosive gasses and excessive dust

Note: Please refer to the user's manual for details of breakdown voltage and insulation resistance.

Individual general specifications

Item	CPU units				Expansion units	
	AFP7CPS4RE(S)	AFP7CPS3RE(S)	AFP7CPS3R(S)	AFP7CPS2R	AFP7EXPM	AFP7EXPS
Rated voltage range	20.4 to 28.8 V DC				–	20.4 to 28.8 V DC
Current consumption	200 mA or less		150 mA or less		120 mA or less	100 mA or less
Net weight	220 g approx. (with terminal block and end unit)				120 g approx.	200 g approx. (with end unit)

Item	Communication cassettes						Function cassettes		
	AFP7CCRS1	AFP7CCRS2	AFP7CCRM1	AFP7CCRM2	AFP7CCRS1M1	AFP7CCRET1	AFP7FCRAD2	AFP7FCRA21	AFP7FCRTC2
Rated voltage range	–	–	–	–	–	–	–	–	–
Current consumption	35 mA or less ^(Note 1)	60 mA or less ^(Note 1)	60 mA or less ^(Note 1)	90 mA or less ^(Note 1)	70 mA or less ^(Note 1)	35 mA or less ^(Note 1)	40 mA or less ^(Note 1)	75 mA or less ^(Note 1)	45 mA or less ^(Note 1)
Net weight	25 g approx. (with terminal block)					20 g approx.	25 g approx. (with terminal block)		

Item	Digital input and output units											
	AFP7X16DW	AFP7X32D2	AFP7X64D2	AFP7Y16R	AFP7Y16T	AFP7Y32T	AFP7Y64T	AFP7Y16P	AFP7Y32P	AFP7Y64P	AFP7Y64D2T	AFP7Y64D2P
Rated voltage range	–	–	–	–	–	–	–	–	–	–	–	–
Current consumption	25 mA or less	30 mA or less	35 mA or less	180 mA or less	35 mA or less	50 mA or less	75 mA or less	35 mA or less	50 mA or less	75 mA or less	55 mA or less	55 mA or less
Net weight	125 g approx.	95 g approx.	110 g approx.	180 g approx.	125 g approx.	95 g approx.	115 g approx.	125 g approx.	95 g approx.	115 g approx.	115 g approx.	115 g approx.

Item	Analog input and output units			Temperature input units		High-speed counter units	
	AFP7AD4H	AFP7DA4H	AFP7AD8	AFP7TC8	AFP7RTD8	AFP7HSC2T	AFP7HSC4T
Rated voltage range	–	–	–	–	–	–	–
Current consumption	100 mA or less	250 mA or less	85 mA or less	80 mA or less	65 mA or less	65 mA or less	65 mA or less
Net weight	130 g approx.	130 g approx.	130 g approx.	145 g approx.	145 g approx.	130 g approx.	130 g approx.

Item	Positioning units				Pulse output units			
	AFP7PP02T	AFP7PP04T	AFP7PP02L	AFP7PP04L	AFP7PG02T	AFP7PG04T	AFP7PG02L	AFP7PG04L
Rated voltage range	–	–	–	–	–	–	–	–
Current consumption	120 mA or less	120 mA or less	120 mA or less	120 mA or less	65 mA or less	65 mA or less	65 mA or less	65 mA or less
Net weight	145 g approx.	145 g approx.	145 g approx.	145 g approx.	130 g approx.	150 g approx.	130 g approx.	150 g approx.

Item	Motion control unit			Multi input/output unit
	AFP7MC16EC	AFP7MC32EC	AFP7MC64EC	AFP7MXY32DWD
Rated voltage range	–	–	–	–
Current consumption	180 mA or less	180 mA or less	180 mA or less	100 mA or less
Net weight	150 g approx.	150 g approx.	150 g approx.	100 g approx.

Item	Serial communication unit	Power supply units		Multi-wire link unit
	AFP7NSCR	AFP7PSA1	AFP7PSA2	AFP7MW
Rated voltage range	–	100 to 240 V AC		–
Current consumption	50 mA or less (when without add-on cassette)	750 mA or less	1,250 mA or less	100 mA or less
Net weight	110 g approx.	240 g approx.	290 g approx.	100 g approx.

Item	PHLS (remote I/O) units										
	AFP7PHLSM	AFPRP1X08D2	AFPRP1X16D2	AFPRP1Y16T	AFPRP1XY16D2T	AFPRP2X08D2E	AFPRP2X16D2	AFPRP2Y16T	AFPRP2XY16D2T	AFPRP2Y04R	
Rated voltage range	–	20.4 to 28.8 V DC									
Current consumption	85 mA or less	100 mA or less	150 mA or less	75 mA or less	120 mA or less	100 mA or less	170 mA or less	40 mA or less	110 mA or less	85 mA or less	
Net weight	110 g approx.	140 g approx.	210 g approx.	210 g approx.	210 g approx.	75 g approx.	75 g approx.	75 g approx.	75 g approx.	75 g approx.	

Note: This value is the increase in CPU unit current consumption.

For Programmable Controller Programming software

Control FPCWIN GR7

Save Time on Programming with User-Friendly Software

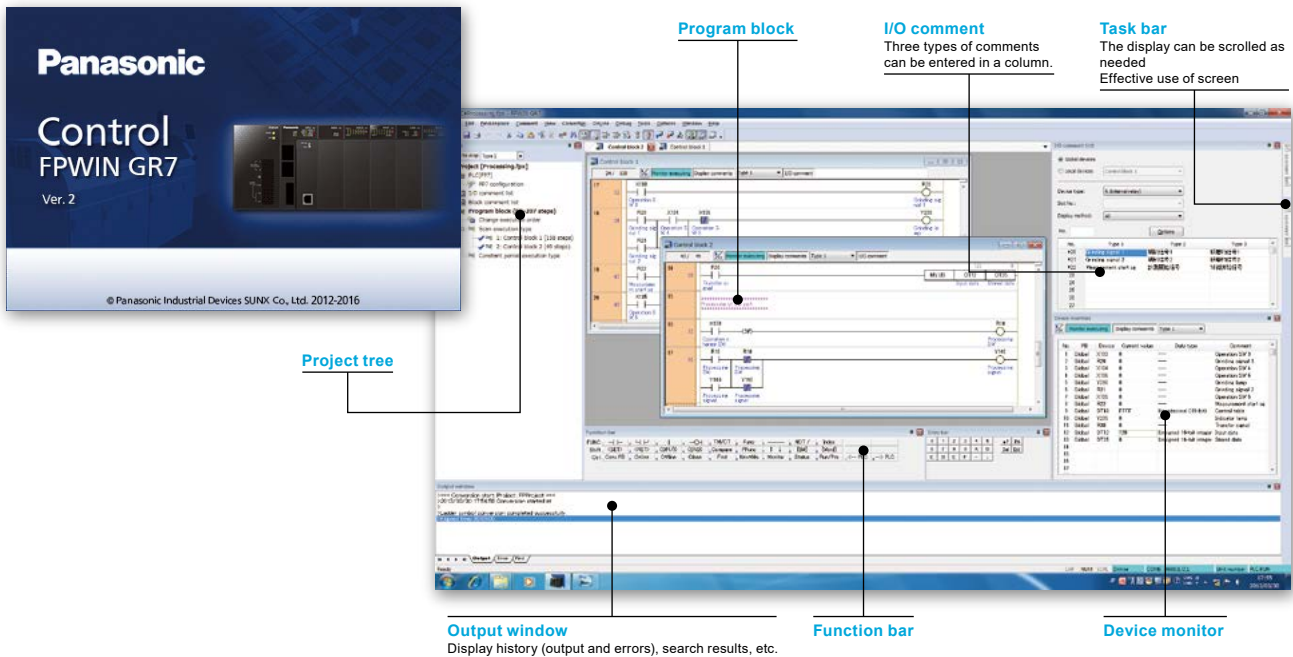

Configuration, editing programming, searching, monitoring, debugging, security, etc.

PLC programming demands a lot of time and effort.

Many programmers get hung up on trying out different configurations, consulting the manual, and re-writing repetitive code blocks.

The **Control FPCWIN GR7** programming software is designed to eliminate these inefficiencies and minimize programming complexity.

Software helps reduce time and effort in various work situations.

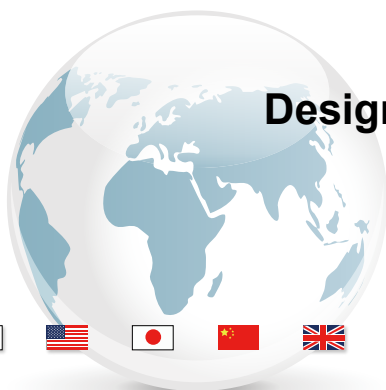
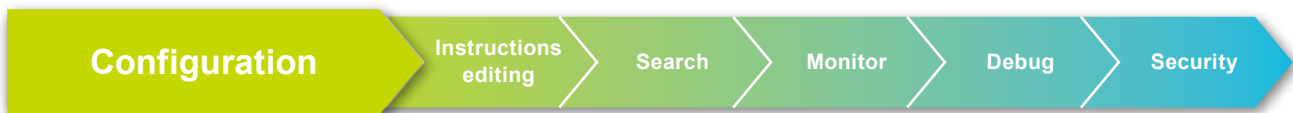

Designed to boost global expansion



For Programmable Controller Programming software

Control F7WIN GR7

Save Time on Initial Setting

Configuration settings, including those for installed units, can be made directly from the same screen.

This eliminates the need to use other software to accomplish this task.

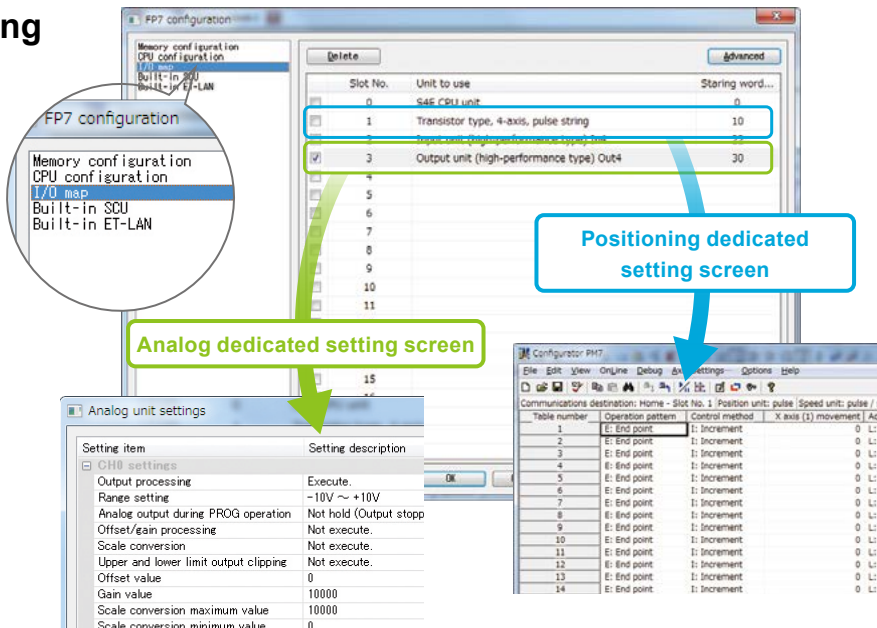

Save Time and Effort by using the "Instruction NAVI".

Enter high level instructions by simply selecting the correct order as dictated by the "Instruction NAVI". The help dialog also supports the selection of high level instructions.

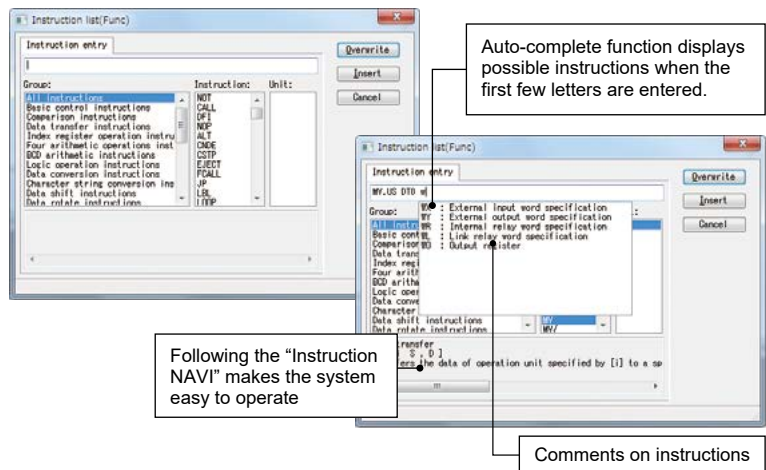

Save Time When Cross-Checking Instructions

Comments are directly switchable on the main screen. Various tasks, such as comment rewriting by end users, can be streamlined.

Bulk imported and exported in CSV format comments enables editing of text only in comments. All languages supported by Windows® are available.

*Windows is a trademark or registered trademark of Microsoft Corporation in the United States and other countries.

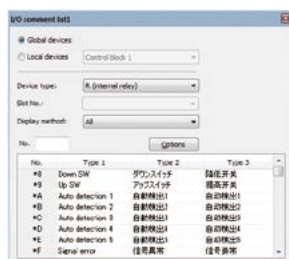

	Example 1	Example 2
Type 1	For design	Japanese
Type 2	For production	English
Type 3	For maintenance	Chinese

Program blocks, block comments, I/O comments and annotation comments can be entered in three types.

Displayed comments on ladder diagram can be switched.

Three comment types can be registered.

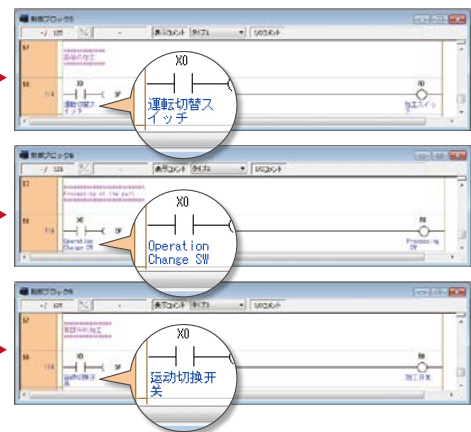

For Programmable Controller

Programming software

Control FWIN GR7

Save Time When Setting up Program Security

Access rights to the CPU unit can be made more stringent for settings, to prevent easy access to editing, or program outflow.

16 separate rights may be set.

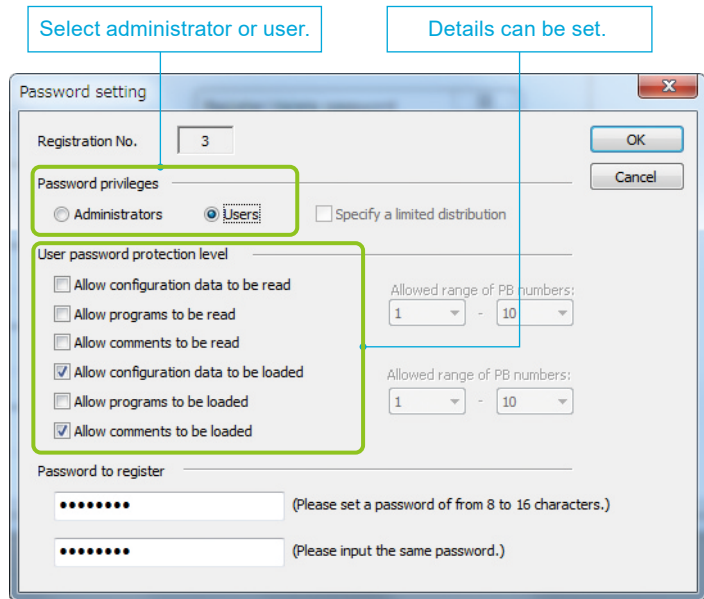
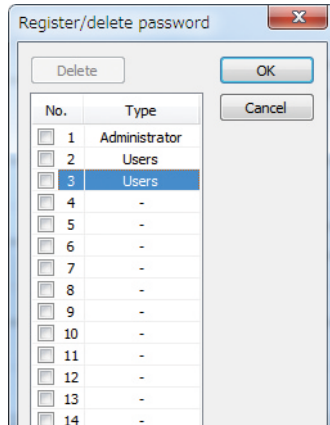

Save Time When Matching Programs

Programs stored in the CPU unit and on the PC can be cross-checked to identify any non-matching portions. This feature is useful for program search and for finding where modifications are needed.

Mismatching program blocks are indicated in pink after program-to-program comparison.

Application example 1

If you want to confirm that programs on the CPU unit and the PC are identical, you can make an instant check.

Application example 2

Content edited by other designers can be checked.

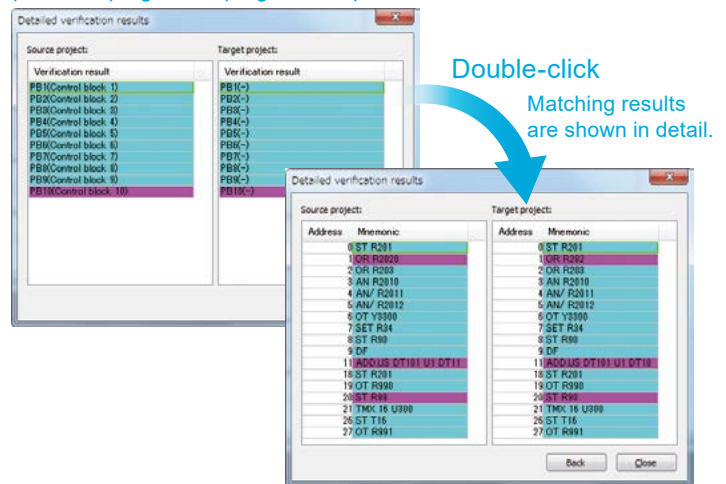

Save Time When Monitoring Operations

Multipoint monitoring devices can be registered easily. It allows you to speed up the monitoring process.

Drag and drop for a single point.

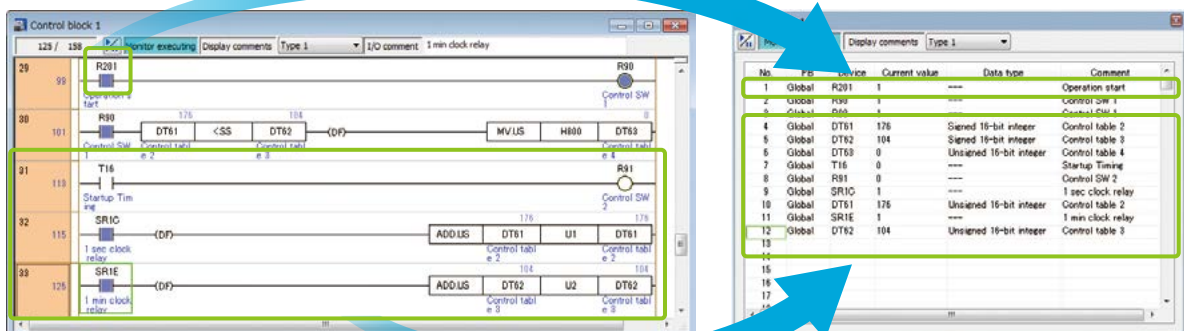

Programming software

Control FPCWIN Pro7

Control FPCWIN Pro7 (IEC61131-3 compliant Windows® version software)

Programming software of PLC open certification corresponds to FP7.

Control FPCWIN Pro is the Panasonic programming software developed according to the international standard IEC 61131-3.

Control FPCWIN Pro is the universal software for all Panasonic PLC's

- Programs written in **Control FPCWIN Pro 6** or earlier versions will run with **Control FPCWIN Pro 7**
- Programs are compatible across **FP** series PLCs, e.g. **FP0R** will run with minor adjustments on **FPΣ** (Sigma) and **FP7** PLCs
- **FP7** PLCs and **Control FPCWIN Pro 7** offer the same flexible choice of editors and allow you to select the programming language you are most familiar with.

*Windows is a trademark or a registered trademark of Microsoft Corporation in the United States and other countries.

The screenshot displays the Control FPCWIN Pro7 software interface with several programming language editors open. On the left is a CD-ROM labeled 'Panasonic Control FPCWIN Pro7 Ver. 7.0'. The main window shows:

- LD (Ladder Diagram):** A ladder logic diagram with inputs bValue0, bTimer0, and outputs bValue0, Output0.
- SFC (Sequential Function Chart):** A state transition chart with states labeled '工程 1へ移行' through '工程 8へ移行'.
- FBD (Function Block Diagram):** A diagram showing function blocks like 'AND', 'OR', 'AND', and 'AND' connected to variables.
- ST (Structured Text):** A text editor showing code for a timer and output control.
- IL (Instruction List):** A list of instructions including LD, AND, OR, ANEN, ST, and CAL.

- **Five programming languages can be used.**
Programming can be done using the language most familiar to the developer or using the language most suited to the process to be performed.
High-level (structured text) languages that allow structuring, such as C, are supported.
5 programming languages: IL (Instruction List), LD (Ladder Diagram), FBD (Function Block Diagram), SFC (Sequential Function Chart), ST (Structured Text)
- **Easy to reuse well-proven programs**
Efficiency when writing programs has been greatly increased by being able to split programming up for each function and process using structured programming.
- **Keep know-how from getting out**
By "black boxing" a part of a program, you can prevent know-how from leaking out and improve the program's maintainability.
- **Source program from PLC can be uploaded.**
Serviceability is improved by being able to read programs and comments from a PLC.
- **Programming for all models in the FP series possible**

For Programmable Controller

Programming software

Control FPCWIN Pro7

- 4 languages are fully supported: English, Japanese, Korean, Chinese
- Well-structured through program organization units, task and project management
- Remote programming, service and diagnostics via modem or Ethernet
- Extensive comments and online documentation created hand in hand with the program
- Min. program size through optimized compiler
- Powerful debugging and monitoring tools provide information on the current status of the PLC.
- Comprehensive printed documentation and support for function blocks and libraries help to get your hardware running in record time while maintaining rigorous quality standards.
- Reuse of functions and function blocks saves time.

Control FPCWIN Pro and its comprehensive, powerful libraries

The PLC programming software **Control FPCWIN Pro** has been evolving for a long time.

As expected, the latest version of the software includes even more function blocks to help you efficiently program your PLC.

The innovations of this version include simplified handling of analog units, serial communication, the integrated clock and **GT** series programmable displays.

The online help was also improved in several key areas:

- Tables for slot number and corresponding address ranges are provided for analog expansion units.
- Explanations for DIP switch settings
- A/D value assignment tables
- Wiring instructions

Additional function blocks for simplifying work with analog values, e.g.:

- Scaling
- Averaging
- Assigning addresses for expansion units

The new function blocks for serial communication cover 90 % of all practical applications, except for telecontrol.

Moreover, diverse tasks for **GT** series programmable displays are now easy to manage,

e.g. changing screens, adjusting brightness, or controlling control bits and words.

Working with times and dates as well as calculations involving times and dates are now extensively supported.

The editors, such as the global variable list editor, offer quick info about PLC addresses, which makes adjusting addresses in the variable declarations as easy as pie.

You can drag & drop variables, function blocks, etc. from the navigation and selection panes into the program editors.

You can copy & paste example programs in the online help into your editor and modify them as necessary.

Product types

CPU units

Product name	Standard program capacity	Max. program capacity	Operation speed	Ethernet function (Note 2)	SD memory card function	Encryption function (Note 3, 4)	Part No.	
FP7 CPU units		196 k steps	234 k steps	From 11 ns	Built-in	Built-in	–	AFP7CPS4RE
		120 k steps	120 k steps	From 11 ns	Built-in	Built-in	–	AFP7CPS3RE
		120 k steps	120 k steps	From 11 ns	–	Built-in	–	AFP7CPS3R
	Security enhanced type	196 k steps	234 k steps	From 11 ns	Built-in	Built-in	Built-in	AFP7CPS4RES
		120 k steps	120 k steps	From 11 ns	Built-in	Built-in	Built-in	AFP7CPS3RES
		120 k steps	120 k steps	From 11 ns	–	Built-in	Built-in	AFP7CPS3RS
	Best value model	64 k steps	64 k steps	From 14 ns	–	–	–	AFP7CPS2R

Notes: 1) One end unit is attached to the CPU unit.

2) Ethernet function includes FTP server / client function, Web server function, HTTP client function, E-mail sending function and EtherNet/IP compatibility. Ethernet is a registered trademark of Fuji Xerox Co., Ltd. and Xerox Corporation. EtherNet/IP is a trademark of ODVA.

3) When exporting to China, please use a CPU that does not have an encryption function.

4) For CPU units with encryption function, please use the security enhanced type programming tools.

Expansion units

Product name	Specifications	Part No.
FP7 expansion master unit	Expansion of up to 3 slave units possible	AFP7EXPM
FP7 expansion slave unit (Note 1)	Up to 16 units can be connected to 1 slave unit.	AFP7EXPS
Expansion cables	Length: 0.5 m 1.640 ft	AFP7EXPCR5
	Length: 1 m 3.281 ft	AFP7EXPC01
	Length: 3 m 9.843 ft	AFP7EXPC03
	Length: 10 m 32.808 ft	AFP7EXPC10

Notes: 1) One end unit is attached to the expansion slave unit.

2) Expansion unit cannot be used with the AFP7CPS2R CPU unit.

Add-on cassettes

Product name	Specifications	Part No.
FP7 communication cassettes	RS-232C, 1 channel (insulated)	AFP7CCRS1
	RS-232C, 2 channels (insulated)	AFP7CCRS2
	RS-422 or RS-485, 1 channel (insulated)	AFP7CCRM1
	RS-422 or RS-485, 2 channels (insulated)	AFP7CCRM2
	RS-232C, 1 channel (insulated) and RS-485, 1 channel (insulated)	AFP7CCRS1M1
	Ethernet 100Base-TX / 10Base-T	AFP7CCRET1
FP7 function cassettes	Analog input, 2 channels, voltage / current	AFP7FCRAD2
	Analog input and output, input: 2 channels, output: 1 channel	AFP7FCRA21
	Thermocouple input, 2 channels K / J	AFP7FCRTC2

Power supply units

Product name	Input specifications	Output specifications	Other functions	Part No.
FP7 power supply units	100-240 V AC	24 V DC, 1.0 A	System error alarm output contact	AFP7PSA1
	100-240 V AC	24 V DC, 1.8 A	System error alarm output contact and remaining lifespan counting function	AFP7PSA2

Note: Power supply unit cannot be used with the AFP7CPS2R CPU unit.

Input and output units

Product name	Type	Number of points	Connection method	Specifications	Part No.
FP7 input units	DC input	16 points	Terminal block	12 to 24 V DC, common polarity: +/- common, input time constant setting	AFP7X16DW
		32 points	MIL connector	24 V DC, common polarity: +/- common, input time constant setting	AFP7X32D2
		64 points	MIL connector	24 V DC, common polarity: +/- common, input time constant setting	AFP7X64D2
FP7 output units	Relay output	16 points	Terminal block	2 A/point, 5 A/common, 16 points/common (without relay socket)	AFP7Y16R
	Transistor output, sink (NPN)	16 points	Terminal block	Load current: 1.0 A, 5 A/common, 16 points/common	AFP7Y16T
		32 points	MIL connector	Load current: 0.3 A, 3.2 A/common, 32 points/common	AFP7Y32T
		64 points	MIL connector	Load current: 0.3 A / 0.1 A, mixed 3.2 A / common, 32 points/common	AFP7Y64T
	Transistor output, source (PNP)	16 points	Terminal block	Load current: 1.0 A, 5 A/common, 16 points/common	AFP7Y16P
		32 points	MIL connector	Load current: 0.3 A, 3.2 A/common, 32 points/common	AFP7Y32P
64 points		MIL connector	Load current: 0.3 A / 0.1 A, mixed 3.2 A / common, 32 points/common	AFP7Y64P	
FP7 input and output mixed units	DC input transistor output, sink (NPN)	Input: 32 points Output: 32 points	MIL connector	Input: 24 V DC, 32 points/common Output: load current: 0.3 A / 0.1 A, mixed 3.2 A/common, 32 points/common	AFP7XY64D2T
	DC input transistor output, source (PNP)	Input: 32 points Output: 32 points	MIL connector	Input: 24 V DC, 32 points/common Output: load current: 0.3 A / 0.1 A, mixed 3.2 A/common, 32 points/common	AFP7XY64D2P

Analog input and output units

Product name	Specifications	Number of channels	Part No.
FP7 analog input unit (High-speed and multi-channel type)	Voltage / current, conversion rate: 25 μ s/channel, resolution: max. 16 bits, accuracy: ± 0.1 % F.S. or less (at +25 °C +77 °F) (Note)	8 channels	AFP7AD8
FP7 analog input unit (High-speed and high-accuracy type)	Voltage / current, conversion rate: 25 μ s/channel, resolution: max. 16 bits, accuracy: ± 0.05 % F.S. or less (at +25 °C +77 °F), insulation between channels	4 channels	AFP7AD4H
FP7 analog output unit (High-speed and high-accuracy type)	Voltage / current, conversion rate: 25 μ s/channel, resolution: max. 16 bits, accuracy: ± 0.05 % F.S. or less (at +25 °C +77 °F), insulation between channels	4 channels	AFP7DA4H

Note: Please note that the digital converted value corresponding to about 2 V of analog input is stored in the input relay area (WX) for channels which are not connected to input when setting the voltage range with AFP7AD8.

Product types

Temperature input units

Product name	Specifications	Number of channels	Part No.
FP7 thermocouple multiple analog input unit	Thermocouple (K, J, T, N, R, S, B, E, PLII and WRe5-26), voltage / current, conversion rate: 5 ms/channel, resolution: max. 16 bits, accuracy: $\pm 0.1\%$ F.S. (at +25 °C +77 °F), insulation between channels	8 channels	AFP7TC8
FP7 resistance temperature detector input unit	Resistance temperature detector (Pt100, JPt100 and Pt1000), conversion rate: 25 ms/channel, accuracy: $\pm 0.1\%$ F.S. (at +25 °C +77 °F), insulation between channels	8 channels	AFP7RTD8

Note: The temperature input units are compatible with the FP7 CPU units with firmware of Ver. 2.0 or later on page 34. The compatible version of **Control FPWIN GR7** is 2.2 or later.

High-speed counter units

Product name	Specifications				Part No.
	Input time constant	Number of counters	Counter type	Input type	
FP7 high-speed counter units	Selection type	2 channels	Liner counter / ring counter	Individual input: 1 multiple, 2-multiple Direction discrimination input: 1 multiple, 2-multiple 2-phase input: 1 multiple, 2-multiple, 4-multiple	AFP7HSC2T
	Selection type	4 channels	Liner counter / ring counter	Individual input: 1 multiple, 2-multiple Direction discrimination input: 1 multiple, 2-multiple 2-phase input: 1 multiple, 2-multiple, 4-multiple	AFP7HSC4T

Positioning units

Product name	Specifications				Part No.
	Output type	Number of axes controlled	Operation speed	Functions	
FP7 positioning units	Transistor	2 axes	1 pps to 500 kpps	Electronic cam and electronic gear functions, linear interpolation, circular interpolation	AFP7PP02T
		4 axes			AFP7PP04T
	Line driver	2 axes	1 pps to 4 Mpps		AFP7PP02L
		4 axes			AFP7PP04L

Pulse output units

Product name	Specifications			Part No.
	Output type	Number of axes controlled	Operation speed	
FP7 pulse output units	Transistor	2 axes	1 pps to 500 kpps	AFP7PG02T
		4 axes		AFP7PG04T
	Line driver	2 axes	1 pps to 4 Mpps	AFP7PG02L
		4 axes		AFP7PG04L

Motion control units

Product name	Specifications		Part No.
	Real axis	Virtual axis	
FP7 motion control unit EtherCAT® type	16	8	AFP7MC16EC
	32	16	AFP7MC32EC
	64	32	AFP7MC64EC

* EtherCAT is registered trademark and patented technology, licensed by Beckhoff Automation GmbH, Germany.

Multi input/output units

Product name	Specifications			Part No.
	Number of points	Connection method	Functions	
FP7 multi input/output unit	Input: 16 points Output: 16 points	MIL connector	Input: total 16 points, ·DC input: max. 16 points, · High-speed counter: max. 4 channels (1 channel: 4 points), · Interrupt input: max. 8 points, Output: total 16 points, · Transistor output: max. 16 points, · Pulse output: max. 4 channels ^(Note) (1 channel: 2 points), · PWM output: max. 4 channels (1 channel: 1 points), · Comparison output: max. 8 points	AFP7MXY32DWD

Note: Trapezoidal control with acceleration / deceleration not yet supported.

Serial communication unit

Product name	Number of communication cassette	Number of installations of CPU unit	Part No.
FP7 serial communication unit	Max. 2 cassettes	Max. 8 units	AFP7NSCR

Product types

PHLS (remote I/O) master unit

Product name	Max. points	Communication speed	Total distance	Max. number of connections	Part No.
FP7 PHLS master unit	1,008 points	6 Mbps / 12 Mbps	200 m 656 ft (at 6 Mbps) / 100 m 328 ft (at 12 Mbps)	63 slaves	AFP7PHLSM

PHLS (remote I/O) slave units

Product name	Shape	Connection method	Type	Number of points	Specifications	Part No.	
FP7 PHLS slave units	Standard type	Screw-type terminal block	DC input	8 points	24 V DC, common polarity: +, 8 points/common	AFPRP1X08D2	
			DC input	16 points	24 V DC, common polarity: +, 16 points/common	AFPRP1X16D2	
			Transistor output (sink)	16 points	Load current: 0.1 A, common polarity: -, 0.4 A/common, 16 points/common	AFPRP1Y16T	
			DC input transistor output (sink)	Input: 8 points Output: 8 points	Input: 24 V DC, common polarity: +, 8 points/common Output: load current: 0.1 A, common polarity: -, 0.4 A/common, 8 points/common * Input / output common is shared.	AFPRP1XY16D2T	
	Compact type	Connector-type terminal block	e-CON	DC input	8 points	24 V DC, common polarity: +, 8 points/common	AFPRP2X08D2E
				DC input	16 points	24 V DC, common polarity: +, 16 points/common	AFPRP2X16D2
			Connector-type terminal block	Transistor output (sink)	16 points	Load current: 0.1 A, common polarity: -, 0.8 A/common, 16 points/common	AFPRP2Y16T
				Transistor output (sink)	Input: 8 points Output: 8 points	Input: 24 V DC, common polarity: +, 8 points/common Output: load current: 0.1 A, common polarity: -, 0.8 A/common, 8 points/common * Input / output common is shared.	AFPRP2XY16D2T
				Relay output	4 points	1 A/point, 2 A/common, 2 points/common	Orders to end on September 29, 2023 AFPRP2Y04R

Multi-wire link unit

Product name	Specifications	Part No.
FP7 multi-wire link unit	Supports MEWNET-W / MEWNET-W2 / MEWNET-F (PLC link)	AFP7MW

Option

Product name	Specifications	Part No.
FP-X backup battery	Battery for back up of clock / calendar operation	AFPX-BATT

Programming tools

Product name	Type	Specifications	Part No.
Programming software for Windows® Control FPWIN GR7	Japanese version	Supports only CPU unit without encryption function	AFPSGR7JP
	Security enhanced type	Supports both CPU unit with/without encryption function	AFPSGR7JPS
	English version	Supports only CPU unit without encryption function	AFPSGR7EN
	Security enhanced type	Supports both CPU unit with/without encryption function	AFPSGR7ENS
Programming software for Windows® Control FPWIN Pro7	English, Japanese, Korean and Chinese	Supports all FP series PLCs (FP7 series: Supports only CPU unit without encryption function)	AFPSPR7A
	Security enhanced type	Supports all FP series PLCs (FP7 series: Supports both CPU unit with/without encryption function) * The encryption function will be offered in the future.	AFPSPR7AS

Notes: 1) Windows is a registered trademark or trademark of registered trademarks of Microsoft Corporation in the United States and other countries.

2) When exporting to China, CPU unit without encryption function is required.

3) Please use a commercially available USB2.0 cable (A type mini B) for connecting a control unit with a PC.

Web screen creation tools

Product name	Descriptions	Part No.
Control Web Creator	Windows version. Downloadable free of charge from our website. Please purchase Key unit separately.	AFPSWC
Key unit	License key for Control Web Creator . 1 license. For USB port.	AFPSWCKEY

•Key unit
AFPSWCKEY



*Key unit is required to create Web content.
You do not need Key unit to view Web content on a browser.

Motion control setting tools

Product name	Descriptions	Part No.
Motion control setting tool Control Motion Integrator	Windows version. Downloadable free of charge from our website. Please purchase Key unit separately.	AFPSMTEN
Control Motion Integrator Key unit	License key for Control Motion Integrator . 1 license. For USB port. It is required when setting the FP7 motion control unit EtherCAT® type (AFP7MC□□EC). Please purchase Control Motion Integrator if you use it after 60 days since installing it.	AFPSMTKEY









•Key unit
AFPSMTKEY



Product types

Options

Others

Product name	Appearance	Descriptions	Part No.
End unit		Supplied with FP7 CPU unit and expansion slave unit.	AFP7END
FP7 terminal block		Supplied with I/O unit and analog I/O unit with terminal block. (5 pieces)	AFP7TER
Discrete-wire connector set (40 leads)		Supplied with FP7 input and output unit (MIL connector), high-speed counter unit, positioning unit and pulse output unit. (2 pieces)	AFP2801
Flat cable connector set (40 leads)		Supplied with FP7 input and output unit (MIL connector), high-speed counter unit, positioning unit and pulse output unit. For simple connection using a flat cable. (2 pieces)	AFP2802
Multi-wire connector pressure contact tool		Necessary when wiring connectors in the supplied discrete-wire connector set to FP7 I/O units (MIL connector type), high-speed counter units, positioning units or pulse output units.	AXY52000FP
Motor driver I/F terminal II 1 shaft (Note)		Connectable MINAS series with FP7 positioning unit, pulse output unit, FP2 positioning unit (multi-function type) (Connectable line driver output unit only)	Orders to end on September 29, 2023 AFP8503
Motor driver I/F terminal II 2 shafts (Note)			Orders to end on September 29, 2023 AFP8504
MINAS A4 series / A5 series / A6 series exclusive cable 1 m 3.281 ft		Connectable MINAS A4 series, A5 series, A6 series with motor driver I/F terminal II	Orders to end on September 29, 2023 AFP85151
MINAS A4 series / A5 series / A6 series exclusive cable 2 m 6.562 ft			Orders to end on September 29, 2023 AFP85152
Positioning connection cable 0.5 m 1.640 ft		Connectable FP7 positioning unit, pulse output unit, FP2 positioning unit (multi-function type) with motor driver I/F terminal II	Orders to end on September 29, 2023 AFP85100
Positioning connection cable 1 m 3.281 ft			Orders to end on September 29, 2023 AFP85101

Note: Motor driver I/F terminal II (1 shaft and 2 shafts)

- Servo signal of **FP7** positioning unit and **FP7** pulse output unit can not be used. Please use the servo ON terminal of motor driver I/F terminal II.
- Timing input of **FP7** pulse output unit can not be used.

Product types

Pressure contact for multi-wire

Product name	Adapted cable size	Electric wire		Part No.
		Coated diameter	Remarks	
Pressure contact for multi-wire	AWG#22	ø1.5 to ø1.1 mm ø0.059 in to ø0.043 in	AWG#22: 12 wires / 0.18 stranded wire	AXW7221FP
	AWG#24		Stranded wire	
	AWG#26	ø1.3 to ø1.1 mm ø0.051 in to ø0.043 in	Stranded wire	AXW7231FP
	AWG#28		Stranded wire	

Connector terminals

Connector terminals recommended for use with the FP7

•WAGO Company of Japan, Ltd

Connector terminal parts numbers

- PM-M32P-NR2081 (51308331) (straight, poles: 40P, for **FP7** circuits)
- PM-M32P-2081 (51308332) (angled, poles: 40P, for **FP7** circuits)
- IM-M2081-40PC-3A-FP (51308333) (angled, poles: 40P, one-to-one circuits)

Connector terminals



Cable parts numbers (MIL40P → MIL40P)

- Flexible cable
PM-MM40SS-F1M (51227194)
PM-MM40SU-F1M (51224816)
- Flexible cable / shielded
PM-MM40SS-F1M-S (51255411)
PM-MM40SU-F1M-S (51269259)
- Easy cable
PM-MM40SS-E1M (60254323)

Cables



- *1. With "SS" and "SU", the polar orientation of the cable is reversed on the PLC side MIL pole slot.
- *2. Please inquire for lengths other than 1 m [3.281 ft.](#)

To learn more about connector terminals, please contact WAGO Company of Japan, Ltd
<http://www.wago.co.jp/>

•TOYOGIKEN CO., LTD.

- PCN7-1H40 (crimping terminal type, poles: 40P)
- Cable: KB40N-1H1H-*MB (AWG28, unshielded)
- *Cable length (m ft): 0.5 [1.640](#) / 1 [3.281](#) / 1.5 [4.921](#) / 2 [6.562](#)

To learn more about connector terminals, please contact TOYOGIKEN CO., LTD.
<http://www.togi.co.jp/en/>



WH series Lineup

List of related products [Web-based HMI] Programmable display WH series



Add “IoT” to machines with the displays Ready for Industrial IoT

Providing new information to the production site with web technology

Wide selection of screen sizes up to 21.5 inch wide

Advanced model WHA1

- 16,770,000 colors
- Max. 21.5 inch
- SD memory card
- Capacitive type
- Front pure glass
- Web server

Equipped with 3 Ethernet ports* and a capacitive type, the large, high end model enables gesture control.

Standard model WHS1

- 65,536 colors
- Resistive film type
- Web server

Standard model with mid-sized, wide resistive film type for users with focused needs.

*AWHA1C050 is equipped with two Ethernet ports.



	AWHA1C215	AWHA1C156	AWHA1C101	AWHA1C070	AWHA1C050		AWHS1R101	AWHS1R070	AWHS1R043
Screen size	21.5 inch wide	15.6 inch wide	10.1 inch wide	7 inch wide	5 inch wide	Screen size	10.1 inch wide	7 inch wide	4.3 inch wide
Resolution	Full HD	HD	WXGA	WVGA	WVGA	Resolution	——	WVGA	WQVGA
	1920 × 1080	1366 × 768	1280 × 800	800 × 480	800 × 480		1024 × 600	800 × 480	480 × 272
Memory (RAM)	2 GB	2 GB	1 GB	1 GB	512 MB	Memory (RAM)	512 MB	512 MB	512 MB

Main unit

Type	Descriptions								Part No.
	Display	Touch switch	Front cover	Power supply	Communication		USB	SD	
					Ethernet	Serial			
Advanced model	21.5 inch wide TFT	Capacitive type	——	24 V DC	3 ports	1 port RS-232C / RS-422 / RS-485 *Software configurable	2 ports	1 slot	AWHA1C215
	15.6 inch wide TFT								AWHA1C156
	10.1 inch wide TFT				AWHA1C101				
	7.0 inch wide TFT				AWHA1C070				
Standard model	5.0 inch wide TFT	Resistive film type	Black	24 V DC	2 ports	1 port	1 port	——	AWHA1C050
	10.1 inch wide TFT				AWHS1R101				
	7.0 inch wide TFT				AWHS1R070				
	4.3 inch wide TFT							AWHS1R043	

Tool software

Product name	Descriptions	Remarks
xAscender Studio	Screen configuration tool for WH series programmable displays	You can download “xAscender Suite” for free from our website. (Membership registration is required.) “xAscender Suite” includes “xAscender Studio” and “xAscender Client”.
xAscender Client	Tool to enable remote viewing of WH series programmable displays	

Dimensions (unit: mm in)

CPU units

AFP7CPS4RE AFP7CPS4RES AFP7CPS3RE AFP7CPS3RES AFP7CPS3R AFP7CPS3RS AFP7CPS2R

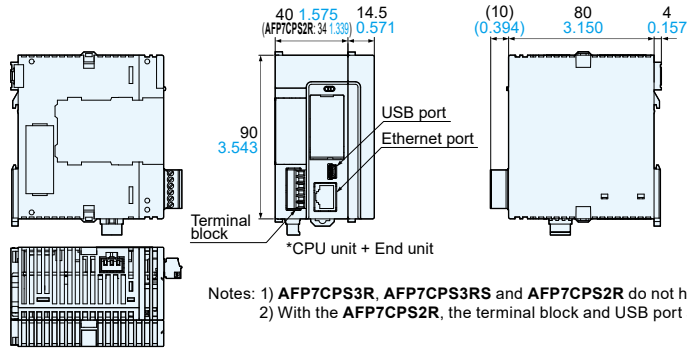

Add-on cassettes

AFP7CCRS1 AFP7CCRS2 AFP7CCRM1 AFP7CCRM2
AFP7CCRS1M1 AFP7FCRA21 AFP7FCRAD2 AFP7FCRTC2

AFP7CCRET1



Power supply units

AFP7PSA1

AFP7PSA2

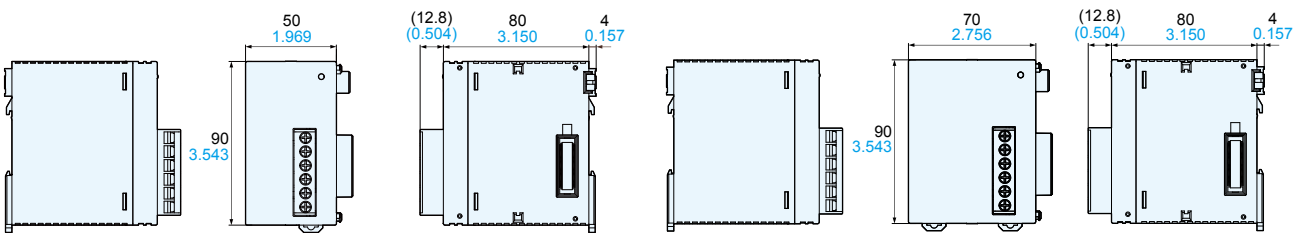

Input and output units / Analog input and output units

AFP7X16DW AFP7Y16R AFP7Y16T AFP7Y16P
AFP7AD4H AFP7AD8 AFP7DA4H

Expansion slave unit

AFP7EXPS

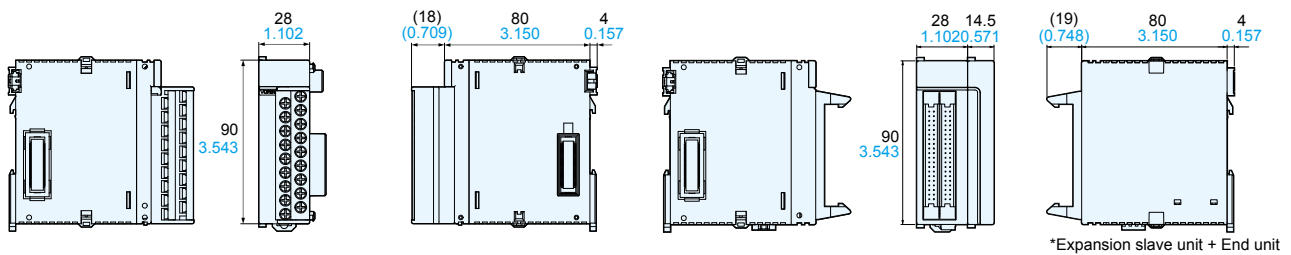

Expansion master units / Input and output units / Multi input/output unit / High-speed counter unit / Positioning units / Pulse output units

AFP7EXPM AFP7X32D2 AFP7Y32T AFP7Y32P AFP7MX32DWD AFP7HSC2T AFP7PP02T AFP7PP02L
AFP7PG02T AFP7PG02L

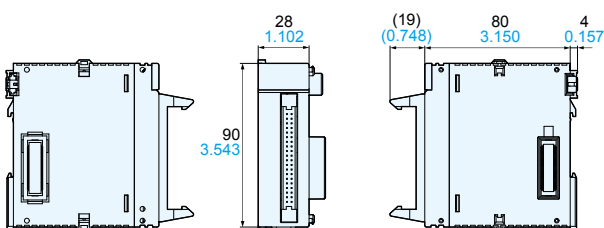

Dimensions (unit: mm in)

Input and output units / High-speed counter unit / Positioning units / Pulse output units

AFP7X64D2 AFP7Y64T AFP7Y64P AFP7XY64D2T AFP7XY64D2P AFP7HSC4T AFP7PP04T AFP7PP04L
AFP7PG04T AFP7PG04L

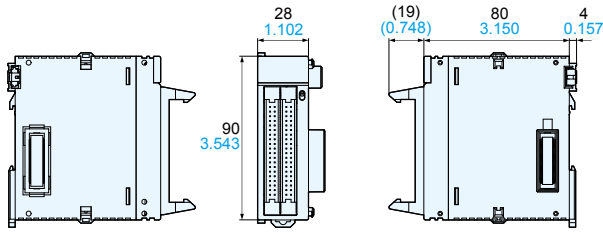

Temperature input units

AFP7TC8 AFP7RTD8

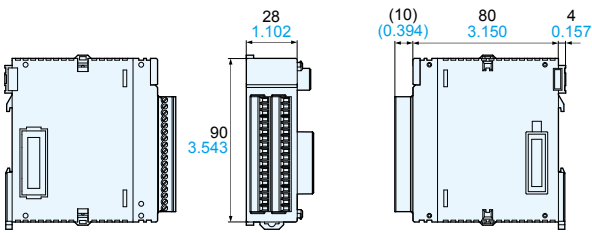

Motion control units

AFP7MC16EC AFP7MC32EC AFP7MC64EC

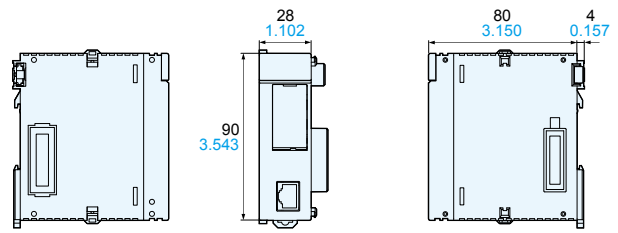

Serial communication unit

AFP7NSCR

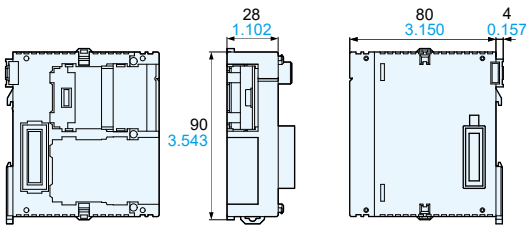

PHLS master unit

AFP7PHLSM

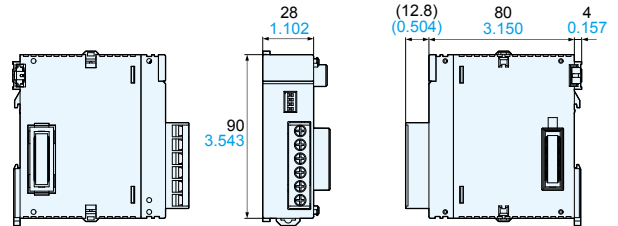

PHLS slave units (standard type)

AFPRP1X16D2 AFPRP1Y16T AFPRP1XY16D2T

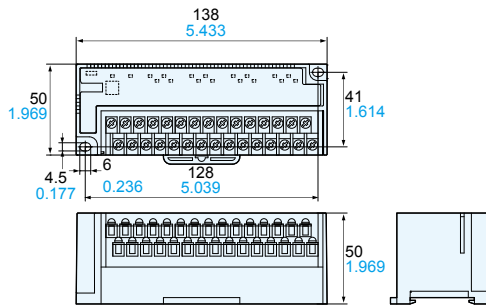

PHLS slave unit (standard type)

AFPRP1X08D2

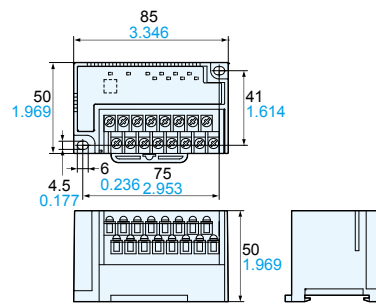

PHLS slave unit (e-CON)

AFPRP2X08D2E

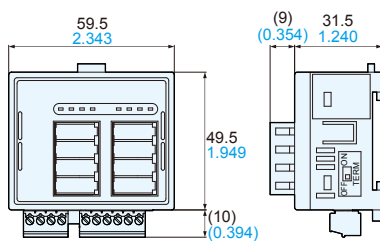

PHLS slave unit (connector type and relay output)

AFPRP2Y04R

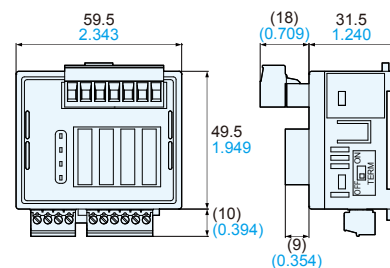

Dimensions (unit: mm in)

■ PHLs slave units (connector type)

AFPRP2X16D2 AFPRP2Y16T AFPRP2XY16D2T

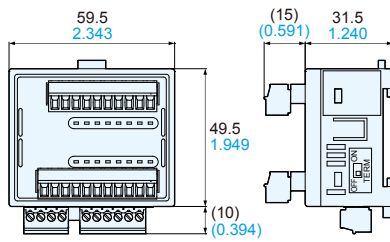

■ Multi-wire link unit

AFP7MW

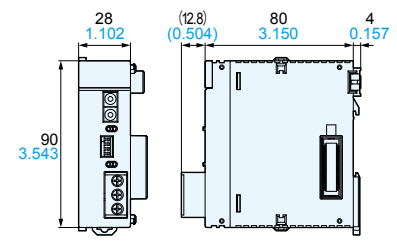

License Information

- This product includes software developed by Eric Young (eay@mincom.oz.au)
- This product includes cryptographic software written by Eric Young (eay@mincom.oz.au)
- This product includes cryptographic software written by Eric Young (eay@cryptsoft.com)
- This product includes software developed by the IEEE Industry Connections Security Group (ICSG)

Panasonic
INDUSTRY

Panasonic Industry Co., Ltd.

Industrial Device Business Division
7-1-1, Morofuku, Daito-shi, Osaka 574-0044, Japan
industrial.panasonic.com/ac/e/