

For detection: Non Seal Type Switches
AEQ (EQ) Switches

Product Catalog

**IN Your
Future**

AEQ (EQ) Switches

Sliding contact construction Switches for Low-level Loads

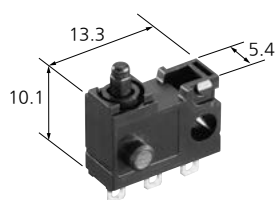

(Unit: mm)

FEATURES

- Handles low level load: 100 μ A at 3 V DC to 100 mA 30 V DC
- Long stroke: For pin plunger type, it maintains OT (Over Travel) with over 2.2 mm on the N.O. side and over 2.5 mm on the N.C. side.
- Since contact pressure does not depend on the operation stroke, the range of possible use over the entire stroke is greatly increased.
- Silent operation construction with sliding contact
- Protection grade: IP40

TYPICAL APPLICATIONS

- Crime prevention devices, Household appliances (Air conditioners, Air purifier, etc.)

ORDERING INFORMATION (PART NO.)

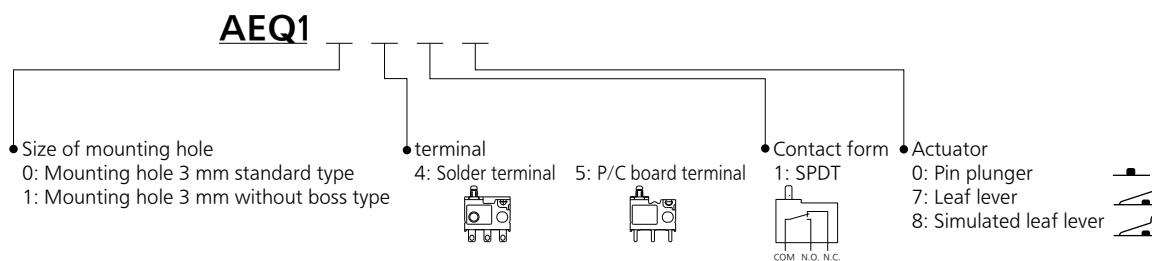

TYPES

Terminal type (Mounting hole: 3 mm standard type / 3 mm without boss type)

Actuator	Operating Force OF, Max.	Mounting hole: 3mm standard type		Mounting hole: 3mm without boss type	
		Solder terminal		P/C board terminal	
Pin plunger	1.2 N	AEQ10410		AEQ11510	
Leaf lever	1.7 N	AEQ10417		AEQ11517	
Simulated leaf lever	1.5 N	AEQ10418		AEQ11518	

RATING

Contact rating

100 μ A 3 V DC to 100 mA 30 V DC.

(Min. switching capacity (Reference value*) 10 μ A 1 V DC)

* This value is a rough indication of the lowest possible low level load at which switching is possible.

This value can change due to the switching frequency, environmental conditions, and desired reliability level, therefore it is recommended to check this with the actual load.

Operation environment and conditions

Item	Specifications
Ambient and storage temperature	-25 to +85°C (no freezing and condensing)
Allowable operating speed	30 to 500 mm/sec
Max. operating cycle rate	120 cpm

Note 1: When switching at low and high speeds or under vibration, or in high-temperature, high-humidity environments, life and performance may be reduced significantly depending on the load capacity. Please consult us.

Note 2:

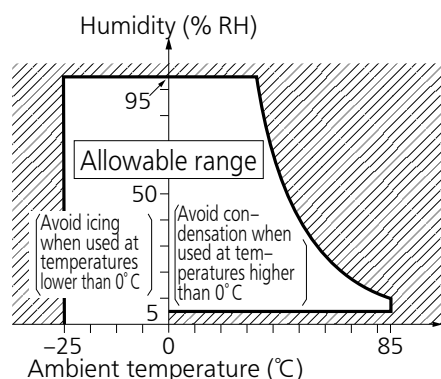

Electrical characteristics

Dielectric strength (Initial)	Between non-continuous terminals: 600 Vrms for 1 min Between each terminal and other exposed metal parts: 1,500 Vrms for 1 min Between each terminal and ground: 1,500 Vrms for 1 min (at detection current of 1 mA)
Insulation resistance (Initial)	Min. 100 M Ω (at 500 V DC insulation resistance meter, Locations measured same as breakdown voltage.)
Contact resistance (Initial)	Max. 1 Ω (by voltage drop 0.1 A, 6 to 8 V DC)

Characteristics

Item	Specifications
Electrical switching life	3 V DC 0.1 mA (resistive load) Min. 2×10^5
	30 V DC 100 mA (resistive load) Min. 10^5
Vibration resistance (malfunction vibration resistance)	Single amplitude: 0.75 mm Amplitude of vibration: 10 to 55 Hz (4 minutes cycle) Direction and time: 2 hours each in X, Y and Z directions
Shock resistance (malfunction shock resistance)	Shock value: 294 m/s ² Direction and time: 3 times each in X, Y and Z directions
Vibration resistance endurance	Frequency of vibration: 33.3 Hz Acceleration: 43.1 m/s ² Direction and time: 8 hours each in X, Y and Z directions
Terminal strength	Min. 6 N (to each direction, applied power at 1 minute) *Terminal deformation possible.
Salt spray resistance	Density of salt water: 5 % Temperature: 35°C each 100 hours At free position (FP) and total travel position (TTP)
Heat and cold resistance	-45 to -40°C 48 hours 85 to 90°C 48 hours
Humidity resistance	40°C 95% RH 96 hours
Unit weight	Approx. 0.8 g
Protection grade	IP40

Note: As long as there are no particular designations, the following conditions apply to the test environment.

- Ambient temperature: 5 to 35°C
- Relative humidity: 25 to 85% RH
- Air pressure: 86 to 106 kPa

Operating characteristics

Characteristics		Pin plunger	Leaf lever	Simulated leaf lever
Operating Force (OF) Max. *Note 1		1.2 N	1.7 N	1.5 N
Total travel Force (TF) Max. (reference value)		(1.8 N)	(3.1 N)	(2.8 N)
Free Position (FP) Max.	From mounting boss and hole center line	9.2 mm	11.5 mm	14.4 mm
	From standoff	13.4 mm	15.7 mm	18.6 mm
Operating Position on N.C. side (OP) N.C. *Note 2, 4	From mounting boss and hole center line	8.7±0.3 mm	9.8±0.5 mm	12.5±0.5 mm
	From standoff	12.9±0.3 mm	14.0±0.3 mm	16.7±0.3 mm
Operating Position on N.O. side (OP) N.O. *Note 3, 4	From mounting boss and hole center line	8.4±0.3 mm	9.3±0.5 mm	12.0±0.5 mm
	From standoff	12.6±0.3 mm	13.5±0.3 mm	16.2±0.3 mm
Release Position on N.C. side (RP) N.C. *Note 5	From mounting boss and hole center line	8.8±0.3 mm	10.1±0.5 mm	12.9±0.5 mm
	From standoff	13.0±0.3 mm	14.3±0.3 mm	17.1±0.3 mm
Release Position on N.O. side (RP) N.O. *Note 6	From mounting boss and hole center line	8.5±0.3 mm	9.6±0.5 mm	12.4±0.5 mm
	From standoff	12.7±0.3 mm	13.8±0.3 mm	16.6±0.3 mm
Over travel on N.C. side (OT) N.C. Min.		2.5 mm	3.1 mm	3.3 mm
Over travel on N.O. side (OT) N.O. Min.		2.2 mm	2.6 mm	2.8 mm
Total Travel Position (TTP) (reference value)	From mounting boss and hole center line	(5.9 mm)	(6.2 mm)	(8.7 mm)
	From standoff	(10.1 mm)	(10.4 mm)	(12.9 mm)

Notes: The above indicates the characteristics when operating the pushbutton from the vertical direction.

1. Indicates operation load for N.O. contact to achieve ON status.
2. Indicates position for N.C. contact to achieve OFF status.
3. Indicates position for N.O. contact to achieve ON status.
4. Although there is some overlap in the range of the operating position (OP) on the N.C. and N.O. sides due to the tolerance, in actuality there is always an intermediate OFF range (the N.C. and N.O. sides will never ON at the same time.)
5. Indicates position for N.C. contact to achieve ON status.
6. Indicates position for N.O. contact to achieve OFF status.

DATA

Applicable current range (Reference)

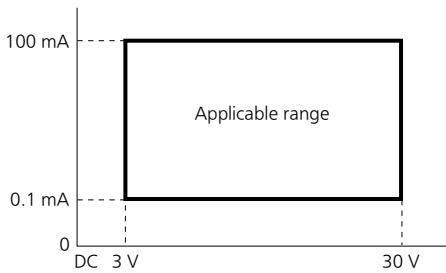

OPERATION CONCEPT DIAGRAM

Contact form: terminal type

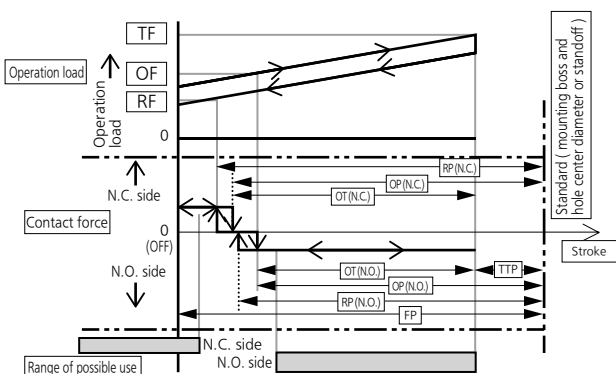

CONTACT FORM

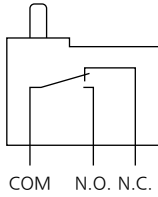

DIMENSIONS

CAD The CAD data of the products with a "CAD" mark can be downloaded from our Website.

Unit: mm

■ Solder terminal; Mounting hole: 3 mm, standard type

CAD

● Pin plunger



External dimensions

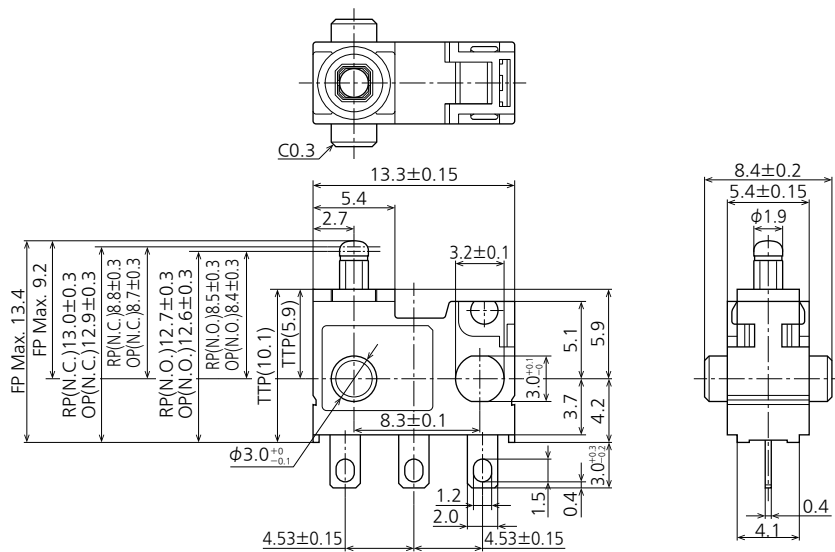

Operating Force (OF) Max.		1.2 N
Total travel Force (TF) Max. (reference value)		(1.8 N)
Free Position (FP) Max.	From mounting boss and hole center line	9.2 mm
	From standoff	13.4 mm
Operating Position on N.C. side (OP) N.C.	From mounting boss and hole center line	8.7±0.3 mm
	From standoff	12.9±0.3 mm
Operating Position on N.O. side (OP) N.O.	From mounting boss and hole center line	8.4±0.3 mm
	From standoff	12.6±0.3 mm
Release Position on N.C. side (RP) N.C.	From mounting boss and hole center line	8.8±0.3 mm
	From standoff	13.0±0.3 mm
Release Position on N.O. side (RP) N.O.	From mounting boss and hole center line	8.5±0.3 mm
	From standoff	12.7±0.3 mm
Over travel on N.C. side (OT) N.C. Min.		2.5 mm
Over travel on N.O. side (OT) N.O. Min.		2.2 mm

● Leaf lever

External dimensions

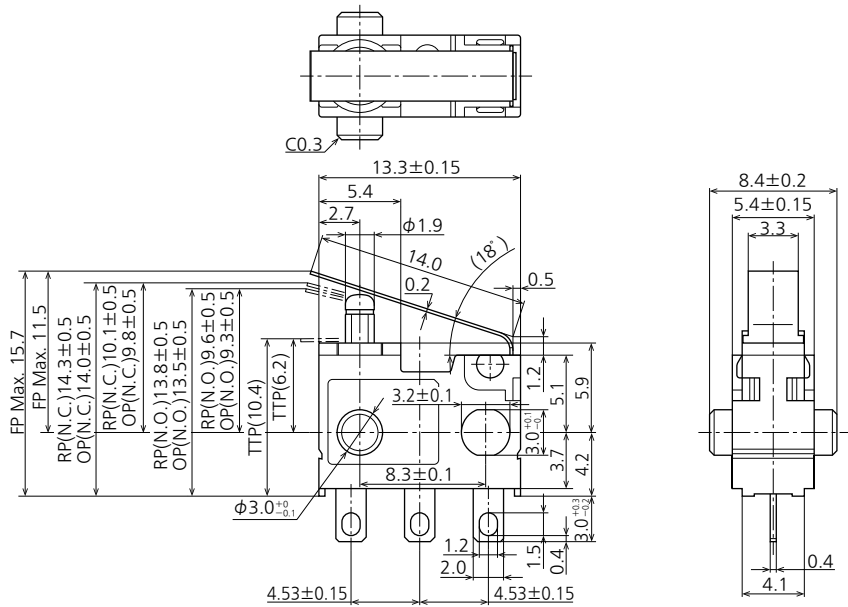

General tolerance: ±0.25

Note) When switching at high speed or under shock, lever endurance may drop. Therefore, please be sure to conduct an endurance evaluation under actual switching conditions.

Operating Force (OF) Max.		1.7 N
Total travel Force (TF) Max. (reference value)		(3.1 N)
Free Position (FP) Max.	From mounting boss and hole center line	11.5 mm
	From standoff	15.7 mm
Operating Position on N.C. side (OP) N.C.	From mounting boss and hole center line	9.8±0.5 mm
	From standoff	14.0±0.3 mm
Operating Position on N.O. side (OP) N.O.	From mounting boss and hole center line	9.3±0.5 mm
	From standoff	13.5±0.3 mm
Release Position on N.C. side (RP) N.C.	From mounting boss and hole center line	10.1±0.5 mm
	From standoff	14.3±0.3 mm
Release Position on N.O. side (RP) N.O.	From mounting boss and hole center line	9.6±0.5 mm
	From standoff	13.8±0.3 mm
Over travel on N.C. side (OT) N.C. Min.		3.1 mm
Over travel on N.O. side (OT) N.O. Min.		2.6 mm

AEQ (EQ) Switches

- Simulated leaf lever

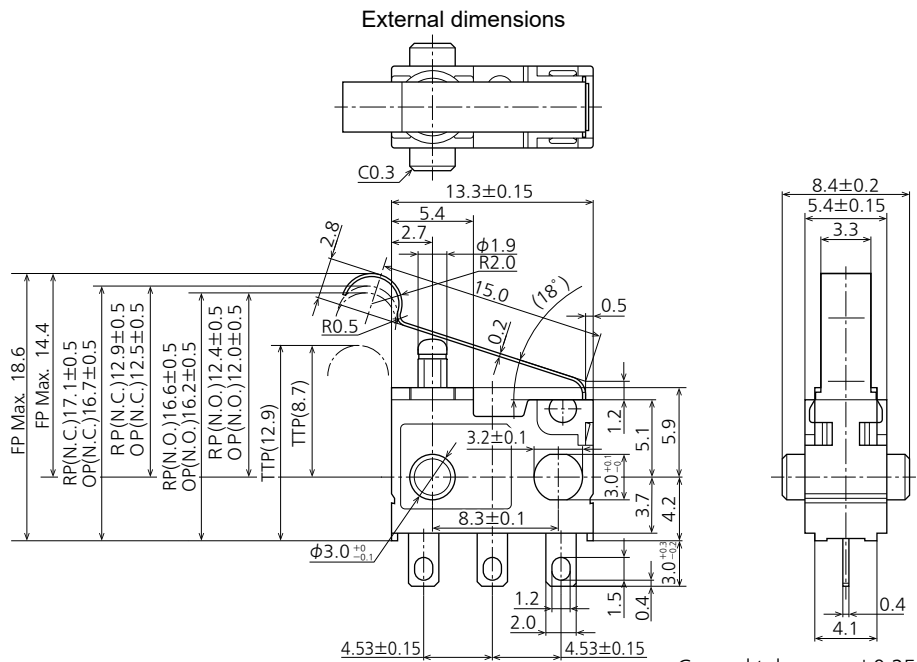

Note) When switching at high speed or under shock, lever endurance may drop.
Therefore, please be sure to conduct an endurance evaluation under actual switching conditions.

Operating Force (OF) Max.		1.5 N
Total travel Force (TF) Max. (reference value)		(2.8 N)
Free Position (FP) Max.	From mounting boss and hole center line	14.4 mm
	From standoff	18.6 mm
Operating Position on N.C. side (OP) N.C.	From mounting boss and hole center line	12.5±0.5 mm
	From standoff	16.7±0.3 mm
Operating Position on N.O. side (OP) N.O.	From mounting boss and hole center line	12.0±0.5 mm
	From standoff	16.2±0.3 mm
Release Position on N.C. side (RP) N.C.	From mounting boss and hole center line	12.9±0.5 mm
	From standoff	17.1±0.3 mm
Release Position on N.O. side (RP) N.O.	From mounting boss and hole center line	12.4±0.5 mm
	From standoff	16.6±0.3 mm
Over travel on N.C. side (OT) N.C. Min.		3.3 mm
Over travel on N.O. side (OT) N.O. Min.		2.8 mm

■ P/C board terminal; Mounting hole: 3 mm, without boss type

CAD

- Pin plunger

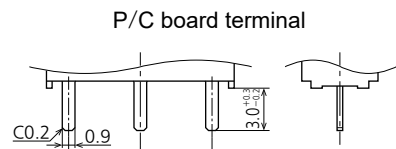
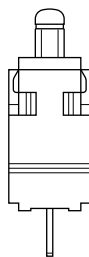
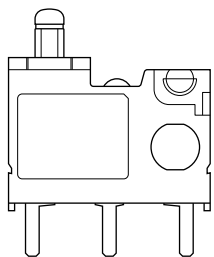

P/C board pattern

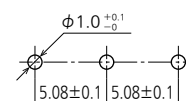

GUIDELINES FOR USAGE

■ Soldering conditions

The application of excessive heat upon the switch when soldering can cause degradation of switch operation. Therefore, be sure to keep within the conditions given below. Manual soldering: use soldering irons (Max. 350°C, within 3 seconds at each terminal) capable of temperature adjustment. This is to prevent deterioration due to soldering heat. Care should be taken not to apply force to the terminals during soldering. (More than one second interval is required to apply heat at each terminal.) Please consult us if you intend to use a soldering iron that exceeds 60 W.

■ Mounting

Please avoid use in which load would be applied to the sides [hatch part (both sides) shown below] of the switch in the direction indicated by the arrows. This could cause erroneous operation. Also, when using a metal installation board, please make allowance for burr direction designation and burr suppressing, etc., so that the burr side will not be on the switch installation side.

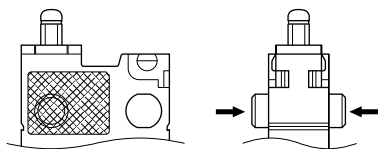

- 1) To secure the switch, please use an M3 small screw on a flat surface and tighten using a maximum torque of 0.29 N·m. It is recommended that spring washers be used with the screws and adhesive be applied to lock the screws to prevent loosening of the screws. Please make sure not to apply adhesive onto the moving parts.
- 2) Be sure to maintain adequate insulating clearance between each terminal and ground.
- 3) Although it is possible to directly operate the pin plunger type from the lateral direction, please consult us if doing so.
- 4) After mounting please make sure no tensile load will be applied to the switch terminals.
- 5) Range of possible use: Please set the operation position to within the ranges in the following table so that there is sufficient insulation distance and to maintain contact reliability.

Actuator	Plunger/lever free		Plunger/Lever pushed	
	From boss and hole center line	From standoff	From boss and hole center line	From standoff
Pin plunger	>9.2 mm	>13.4 mm	7.8 to 5.9 mm	12.0 to 10.1 mm
Leaf lever	>10.7 mm	>14.9 mm	8.4 to 6.2 mm	12.6 to 10.4 mm
Simulated leaf lever	>13.5 mm	>17.7 mm	11.1 to 8.7 mm	15.3 to 12.9 mm

- 6) P/C board terminal type should be used if the products are to be soldered on the P/C board. (Solder terminal type is not for soldering on P/C board.)

■ Cautions regarding the circuit

- 1) In order to prevent malfunction in set devices caused by bounce and chattering during the ON-OFF switch operation, please verify the validity of the circuit under actual operating conditions and temperature range.
- 2) When switching inductive loads (relays, solenoids, buzzers, etc.), an arc absorbing circuit is recommended to protect the contacts.

■ Please verify under actual conditions.

Please be sure to conduct quality verification under actual operating conditions in order to increase reliability during actual use.

■ Selection of switch

Please make your selection so that there will be no problems even if the operating characteristics vary up to ±20% from the standard values.

■ Others

- 1) Keep away from environments where silicon based adhesives, oil or grease are present as faulty contacts may result from silicon oxide. Do not use in areas where flammable or explosive gases from gasoline and thinner, etc., may be present.
- 2) When using the lever type, please be careful not to apply unreasonable load from the reverse or lateral directions of operation.
- 3) Do not exceed the total travel position (TTP) and press the actuator. This could cause operation failure. Also, when switching at high speed or under shock even within the operation limit, the working life may decrease. Therefore, please be sure to verify the quality under actual conditions of use.
- 4) Please make considerations so that the switch does not become the stopper for the operating part. The switch could break.

■ Quality Assurance

We make every effort assure the quality of these parts.

To prevent as far as possible the effects of unforeseen circumstances that do not correspond with those described in this specification, we request that you provide us with specifications of the product in which these parts will be used, along with details of the destination and conditions of use of your finished product, and the mounting mechanism of the parts.

To minimize the risk of product liability, in the unlikely event that a quality defect in any of these parts causes a significant impact on property or human life, to supplement the warranted operations and performance figures described in this specification, we recommend the implementation of safety measures such as redundant circuits.

The quality of these parts is assured for one year after delivery to your company. Quality assurance is limited solely to the items described in this specification and operation within the ranges specified. After you have received a part, in the unlikely event that it proves defective, acting in good faith, we will promptly send you a replacement or replace or repair the defective part at the place of delivery.

However, this warranty does not apply in the circumstances listed below.

- 1) We accept no responsibility for other failures that may be attributed to a defect or failure of the delivered parts.
- 2) After receipt by your company, conditions other than those described in these specifications that occur during handling, storage, and transportation (conveyance).
- 3) When a phenomenon that could not have been foreseen has been caused by technology put to practical use at the time of delivery of the part to your company.
- 4) Failures due to natural or man-made disasters such as earthquakes, floods, fires, public or industrial disturbances and other events that are not the fault of our company.

The above stipulations apply only to parts purchased and used in Japan. If you are considering purchasing or using these parts outside of Japan, please consult our sales office.

Please refer to **"the latest product specifications"** when designing your product.

•Requests to customers:

<https://industrial.panasonic.com/ac/e/salespolicies/>

TECHNICAL TERMINOLOGY

■ Detection Switches

A compact switch equipped with an enclosed micro-gap snapaction contact mechanism that makes a specified motion with a specified force to open/close a circuit, and an actuator outside the enclosure (hereinafter referred to as the switch)

■ Actuator

A part of the switch that transmits the received external force to an internal spring mechanism to move the movable contact so that the switch can be opened and closed

■ Actuator stopper

A part of the switch to limit the actuator movement in the switch operation direction

■ Rated values

Values indicating the characteristics and performance guarantee standards of the snap-action switches. The rated current and rated voltage, for instance, assume specific conditions (type of load, current, voltage, frequency, etc.).

■ Mechanical life

The service life when operated at a preset operating frequency without passing electricity through the contacts. (The life test is performed at a switching frequency of 60 times/minute and operating speed of 100 mm/second at the regular cam.)

■ Electrical life

The service life when the rated load is connected to the contact and switching operations are performed. (The life test is performed at a switching frequency of 20 times/minute and operating speed of 100 mm/second at the regular cam.)

■ Contact form

This refers to the components determining the type of application which make up the electrical input/output circuits in the contact.

SPDT	
SPST-N.C.	
SPST-N.O.	

■ Insulation resistance

Resistance between non-continuous terminals, each terminal and other exposed metal parts and between each terminal and ground.

■ Dielectric

Threshold limit value that a high voltage can be applied to a predetermined measuring location for one minute without causing damage to the insulation.

■ Contact resistance

This indicates the electrical resistance at the contact part. Generally, this resistance includes the conductor resistance of the spring and terminal portions.

■ Vibration resistance

Malfunction vibration ... Vibration range where a closed contact does not open for longer than a specified time due to vibrations during use of the snap-action switches.

■ Shock resistance

Shock durability ... Shock range where the mechanical shocks received during snap-action switches transport and installation do not damage the parts or harm the operating characteristics.
Malfunction shock ... Shock range where a closed contact does not open for longer than a specified time due to shocks during use of the snap-action switches.

TECHNICAL TERMINOLOGY

■ Definition of operating characteristic

The main terminological illustrations and meanings which are used with snapaction switches are as follows.

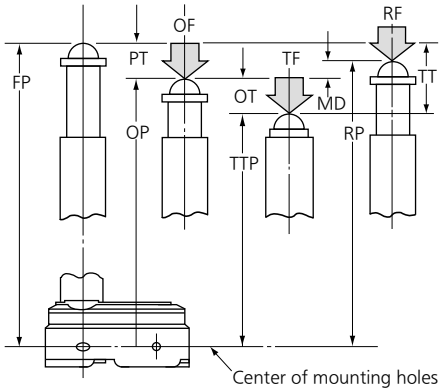

Classification	Terminology	Symbol	Unit	Varying display method	Starting current
Force	Operating Force	OF	N	Max.	The force required to cause contact snap-action. It is expressed terms of force applied to the the actuator.
	Release Force	RF	N	Min.	The force to be applied to the the actuator at the moment contact snaps back from operated position to total travel position.
	Totaltravel Force	TF	N		Force applied to an actuator required to move from an operating position to a total travel position
Movement	Pretravel	PT	mm, degree	Max.	Distance or agree of the actuator movement from free position to operating position.
	Overtravel	OT	mm, degree	Min.	The distance or degree which the actuator is permitted to travel after actuation without any damage to the switching mechanism.
	Movement Differential	MD	mm, degree	Max.	The distance or degree from operating position to release position of the actuator.
	Totaltravel	TT	mm, degree		The migration length or the move angle from the free position to total travel position of actuator
Position	Free Position	FP	mm, degree		Position of the actuator when no force is applied to.
	Operating Position	OP	mm, degree	±	The position of the actuator when the traveling contacts snaps with the fixed contact.
	Release Position	RP	mm, degree		The position of the actuator when the traveling contact snaps back from operating position to its original position.
	Total travel Position	TTP	mm, degree		The stopping position of the actuator after total travel.

TECHNICAL NOTES ON MECHANICAL CHARACTERISTICS

Actuation Force and Stroke

Adequate stroke setting is the key to high reliability. It is also important that adequate contact force be maintained to ensure high reliability. For a normally closed (N.C.) circuit, the driving mechanism should be set so that the actuator is normally in the free position. For a normally open (N.O.) circuit, the actuator should be pressed to 70% to 100% of the specified stroke to absorb possible errors. If the stroke is set too close to the operating point (OP), this may cause unstable contact, and in the worst case may cause actuator damage due to inertia of the drive mechanism. It is advisable that the stroke be adjusted with the mounting plate or driving mechanism.

The figure at right shows a typical example of activation and contact forces varying with stroke. In the vicinity of the OP and RP, the contact force is diminished, causing chatter and contact bounce immediately before or after reversal. For this reason, use the switch while giving due consideration to this. This also causes the snap action switch to be sensitive to vibration or shock.

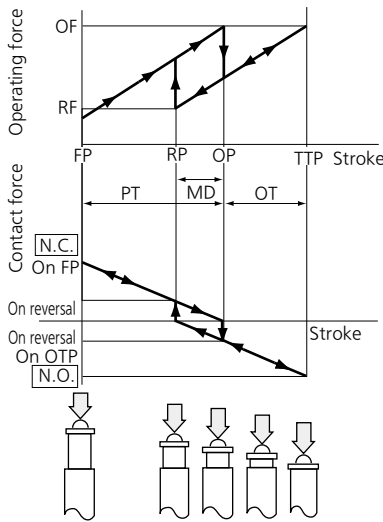

Changes in Operating Characteristics

Exercise design care so that malfunctions will not occur if the operating characteristics vary by as much as 20% from, rated values.

<Example>

In the OF Max. 0.98N specification for FS snap-action switches, the allowable Max. is 0.98 N (100%+20%) = 1.18 N

In the RF Min. 0.15 N Min. specification the allowable Min. 0.15 N (100%-20%) = 0.12 N

Mechanical Conditions for Type Selection

Actuator type should be selected according to activation method, activation speed, activation rate, and activation frequency.

- 1) An extremely slow activation speed may cause unstable contact transfer, possibly resulting in contact failures or contact fusion.
- 2) An extremely high activation speed may cause damage to contacts or contact response failure.

Driving Mechanism

Use of a driving mechanism which will cause physical impact to the actuator should be avoided.

<Example>

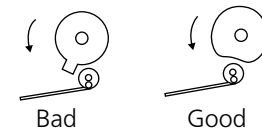

TECHNICAL NOTES ON ELECTRICAL CHARACTERISTICS

- 1) The snap-action switch is designed for AC operations. While it has small contact gaps and no arc absorber, it may be used for low-capacity DC operations. Please refer to the rating of each products
- 2) For applications with very small switching voltage or current, choose the low-level load type (Au contact).

Small current and voltage application range (Au contact)

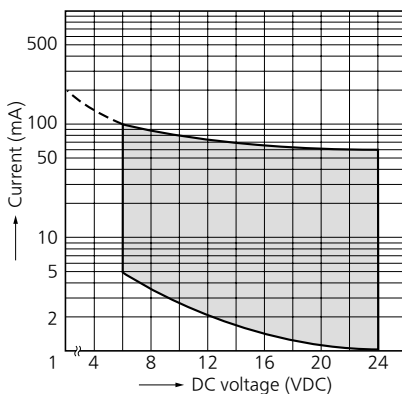

- 3) When selecting a contact type of a snap-action switch to be used for low-level load switching, the following should be noted. Silver contacts' surfaces are prone to be oxidized and form a sulfide film. The switch operates with no problems at the beginning of use. However, as the contact surfaces develop films with time, the film may not be broken by the switching operation, causing a conduction failure. Therefore, please choose the Au contact type for switching a load of 0.1 A or below.
- 4) Application to Electronic Circuits
 - The snap-action switch contacts can sustain bounce or chatter when closed. Bounce or chatter can cause noise or pulse count errors when the snap action switch is used in electronic circuits.
 - If contact bounce or chatter poses problems in the vicinity of the OP and RP, use a suitable absorption network, such as a C/R network.
- 5) Check the surge current, normal current and surge duration.
- 6) Contact resistance given in performance specifications is measured with a voltage drop method using 6 to 8 V DC, 1 A (except for low-level load type). Contact resistance across COM and N.C. terminals is measured in the free position, while contact resistance across COM and N.O. terminals is measured in the total travel position.
- 7) To prevent contact welding failure, be sure to use a serial resistance for each capacitive load.
- 8) If snap-action switch operation is synchronized with the AC supply phase, this may cause: shortened electrical life, contact fusion failure, contact transfer, or other reliability problems.

CAUTIONS IN A CIRCUIT

1) Contact protection is recommended when snap-action switches are used in an inductive load circuit.

Circuit diagram	Cautions for use
<p>Contact for snap-action switch</p>	<p>(1) $r =$ more than 10Ω (2) In an AC circuit Impedance of R is to be slightly smaller than impedance of r and c.</p>
<p>Contact for snap-action switch</p>	<p>Can be used for both AC and DC. Impedance of r is nearly equal to impedance of R. C: $0.1 \mu\text{F}$</p>
<p>Contact for snap-action switch</p>	<p>(1) For DC circuits only.</p>
<p>Contact for snap-action switch</p>	<p>Can be used for both AC and DC.</p>

2) Do not connect the contacts on individual switches to different type or different poles of the power supply.

Examples of power supply connections (connection to different poles)

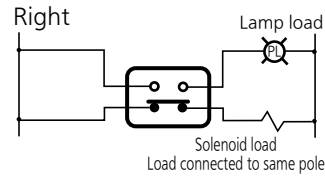
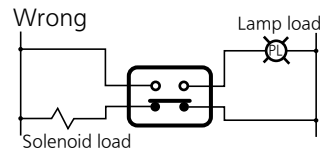

Example of wrong power supply connection (connection to different poles of power supply)

This may lead to mixed DC and AC.

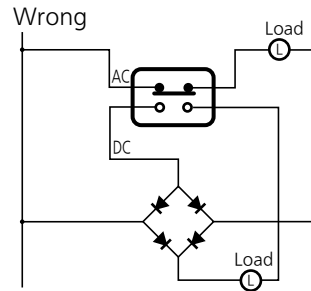

3) Avoid circuits which apply voltage between contacts. (This may lead to mixed deposition.)

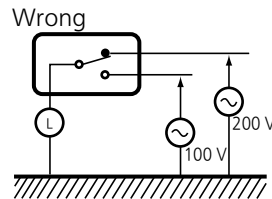

MOUNTING STATE AND ENVIRONMENT

■ Checking the insulation distance

After mounting and wiring, check the insulation distance between terminals and the ground. If the insulation distance is inadequate, mount insulating material between as required.

■ Fastening the snap-action switch body

See the Section "CAUTIONS FOR USE" for the individual switch.

■ Position adjustment with effector

- 1) The effector should be positioned so that direct force is not applied to the plunger or actuator in its free position. The operating force to the plunger should only be applied in a perpendicular direction.
- 2) Note that the use of the switch as a stopper may cause an operational problem.

■ Switch installation position

● Basically, the switch should be installed so that the object to press the switch's plunger or lever can press it down to 70 to 100% of OT of the switch. When determining the position, the tolerance of OP (Operating Position) and other factors should be taken into account. The following describes the case where the strictest tolerance conditions are adopted.

● Example: Hinge lever type FS switch

Reference values: OP = 8.8 ± 0.8 mm
 PT = Max. 2.8 mm
 OT = Min. 1.2 mm

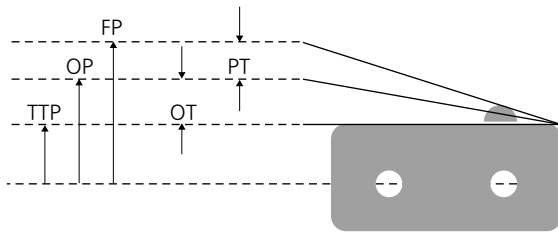

- (1) When the switch is not pressed
 The object to press the lever should not be in contact with the lever.
 For this purpose, the object should be at a distance from the switch fater than the maximum FP (Free Position) value.
 $FP \text{ Max} = OP \text{ Max} + PT \text{ Max} = 9.6 + 2.8 = 12.4 \text{ mm Max}$
 The object should be at a distance of 12.4 mm or more from the mounting hole.
- (2) Depressed position
 The plunger/lever should be pressed down to 70% or more of OT (Over Travel). Therefore, the depressed position should be calculated based on the minimum value of OP (Operating Position) and the 70 and 100% of the OT value.
 $OP \text{ Min} - 70\% \text{ of OT} = 8.0 - 0.84 = 7.16 \text{ mm}$
 $OP \text{ Min} - 100\% \text{ of OT} = 8.0 - 1.2 = 6.80 \text{ mm}$
 The plunger/lever should be pressed down to the position of 6.80 to 7.16 mm from the mounting hole.

■ Soldering precautions

For manual soldering, lay the terminals flat (horizontal with the ground) and quickly perform the soldering operation using a soldering iron with the appropriate heat capacity and the proper amount of solder. Take care that the flux does not flow into the switch interior by using a ventilation fan to discharge flux gas and to prevent contact of the switch body with the soldering iron tip. Be careful not to apply force to the lead wires or the terminal portions immediately after soldering.

The temperature setting and time conditions vary depending on the product.

See the section "CAUTIONS FOR USE" for each product.

<Examples>

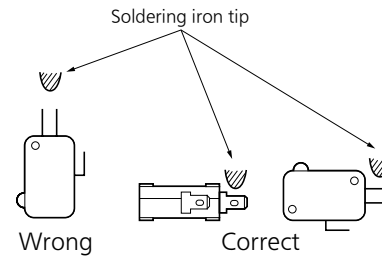

■ Avoid using in a silicon atmosphere

Avoid using organic silicon rubber, adhesives, sealing compounds, oil, grease, and wires in a silicon atmosphere.

■ Please consult us when using under the following conditions*:

- 1) Environments where hydrogen sulfide or other corrosive gases are present.
- 2) Environments where gasoline, thinner or other flammable, explosive gases are present.
- 3) Dusty environments (for non-seal type snap action switches).
- 4) The perpendicular operating speed exceeds the allowable operating speed.
- 5) Switching between different poles.
- 6) Use in environments not in the prescribed temperature or humidity range.

■ Storage precautions

To prevent discoloration due to sulfurization of the terminals (silver-plated), store the switches in a polyethylene bag or other suitable airtight container.

■ Usage, storage, and transport conditions (except turquoise switches)

During usage, storage, or transportation, avoid locations subject to direct sunlight and maintain normal temperature, humidity, and pressure conditions.

The allowable specifications for environments suitable for usage, storage, and transportation are given below.

- 1) Temperature: The allowable temperature range differs for each switch, so refer to the switch's individual specifications. In addition, when transporting or storing switches while they are tube packaged, there are cases when the temperature may differ from the allowable range. In this situation, be sure to consult the individual specifications.
- 2) Humidity: The allowable humidity range differs for each switch, so refer to the switch's individual specifications.
- 3) Pressure: 86 to 106 kPa
The humidity range varies with the temperature. Use within the range indicated in the graph below.

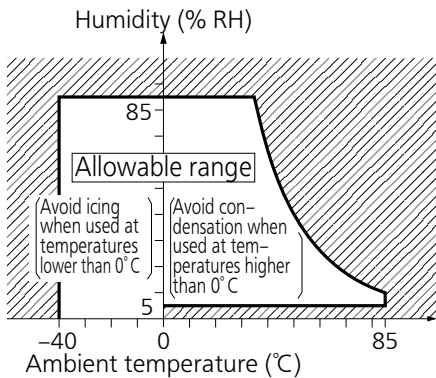

(The allowable temperature depends on the switch.)

- Condensation will occur inside the switch if there is a sudden change in ambient temperature when used in an atmosphere of high temperature and high humidity. This is particularly likely to happen when being transported by ship, so please be careful of the atmosphere when shipping. Condensation is the phenomenon whereby steam condenses to cause water droplets that adhere to the switch when an atmosphere of high temperature and humidity rapidly changes from a high to low temperature or when the switch is quickly moved from a low humidity location to one of high temperature and humidity.
Please be careful because condensation can cause adverse conditions such as deterioration of insulation, coil cutoff, and rust.
- Condensation or other moisture may freeze on the switch when the temperatures is lower than 0°C 32°F. This causes problems such as sticking of movable parts or operational time lags.
- The plastic becomes brittle if the switch is exposed to a low temperature, low humidity environment for long periods of time.
- Storage for extended periods of time (including transportation periods) at high temperatures or high humidity levels or in atmospheres with organic gases or sulfide gases may cause a sulfide film or oxide film to form on the surfaces of the contacts and/or it may interfere with the functions. Check out the atmosphere in which the units are to be stored and transported.
- In terms of the packing format used, make every effort to keep the effects of moisture, organic gases and sulfide gases to the absolute minimum.

■ We reserve the right to modify without notice the materials, internal components, and other parts to improve product quality.

■ Handling precautions





When handling the switches, be careful not to drop them on the floor since this may damage them.

* Select contact sulfurization (clipping) prevention products (FS and Au-clad double layer contacts) for use with extremely small loads or an environment-resistant Turquoise switch.

■ Others

- 1) Failure modes of switches include short-circuiting, opencircuiting and temperature rises. If this switch is to be used in equipment where safety is a prime consideration, examine the possible effects of these failures on the equipment concerned, and ensure safety by providing protection circuits or protection devices. In terms of the systems involved, make provision for redundancy in the design and take steps to achieve safety design.
- 2) The ambient operating temperature (and humidity) range quoted is the range in which the switch can be operated on a continuous basis: it does not mean that using the switch within the rating guarantees the durability performance and environment withstanding performance of the switch. For details on the performance guarantee, check the specifications of each product concerned.

Technical Terminology & Cautions for Use (Detection Switches)

Shape	Classification	Pretravel (PT)	Overtravel (OT)	Operating Force (OF)	Vibration Shock	Features
	Pin plunger	Small	Small	Large	Outstanding	Appropriate for linear short-stroke action. Pin plunger acts directly on snap action mechanism, enabling high-precision positioning. Amount of movement after operation is smallest among all of the actuators, however, so reliable stopper is required.
	Hinge lever	Large	Medium	Small	Possible	Little force required for operation. Appropriate for use with low-speed cams and dogs; has large stroke. Lever available in various shapes to fit operating unit.
	Simulated roller lever	Large	Medium	Small	Possible	Tip of hinge lever is bent into a semi-circle, enabling use as a simple roller type.
	Leaf lever	Large	Large	Small	Excellent	Play in lever is used to assure maximum stroke. Construction provides for space where lever is attached, for outstanding resistance to freezing.
	Hinge roller lever	Large	Medium	Small	Possible	This is a hinge lever with a roller, and can be used with high-speed cams and dogs. The force required for pin plunger action is lighter than that of the lever, and the stroke is longer.

Panasonic
INDUSTRY

Panasonic Industry Co., Ltd.

Electromechanical Control Business Division
■1006, Oaza Kadoma, Kadoma-shi, Osaka 571-8506, Japan
industrial.panasonic.com/ac/e/