

Active Optical Connector
V Series
(LC Connector type)

Product Catalog

**IN Your
Future**

V Series (LC Connector type)

High-speed transmission of large data can be easily achieved Intra- or Inter-device connection.

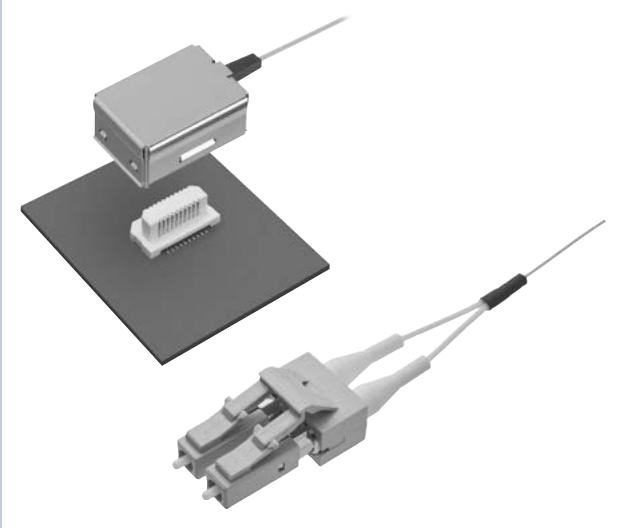

FEATURES

- Long-distance high-speed, wide data rate transmission, and relay connections are possible.
- Easily achieved long-distance transmission by relay connection with a Duplex-LC connector. (Compliant IEC61754-20 standard)
- Separable optical transmission part for easy wiring and assembly.
- Easily achieved optical transmission by connecting an electrical connector to PC board.
- High-speed transmission with noise resistance or electrical isolation.
- Small, lightweight, wire-saving, and low power consumption for high-speed transmission.

TYPICAL APPLICATIONS

- Measuring equipment, Image processing instrument, Industrial robots, Printer, Medical equipment, etc. and other high speed transmission, noise reduction and electrical isolation applications

DETAILED FEATURES

■ Long-distance high-speed, wide data rate transmission, and relay connections are possible.

Easily achieved long-distance transmission by relay connection with a Duplex-LC connector.

(Compliant IEC61754-20 standard)

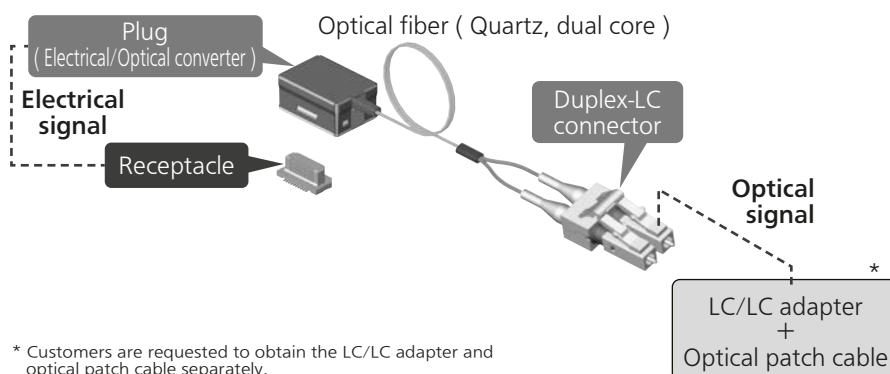

- **1 channel-Bi-direction: Max. 8 Gbps transmission**
Being able to reverse the dual core optical fiber transfer direction makes it ideal for such applications as mutual high speed transfer between connected PC boards.

Active Optical Connector V Series (LC Connector type)

- The differential input signal is converted to an optical signal by Laser Diode Driver (LDD) and Laser Diode (LD) in the plug. The optical signal is transmitted through the optical fiber and output from Duplex-LC connector.
- The optical signal that is input from Duplex-LC connector is reproduced to electrical signal by Photo Diode (PD) and Trans Impedance Amplifier (TIA) and output as differential output signal.

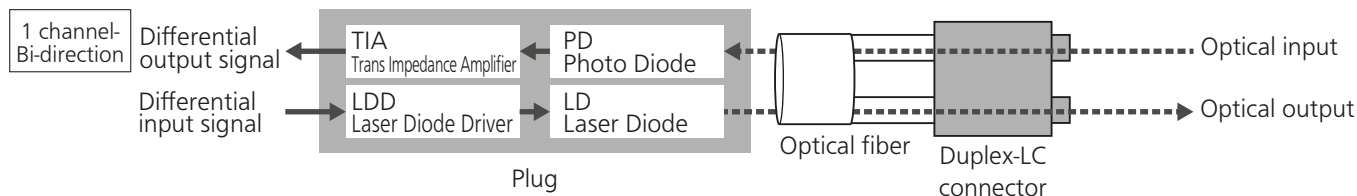

PRODUCT TYPES (1 channel-Bi-direction)

■ Integrated cable and plug

Transmission rate	Transmission specifications	Cable length	Part No.	Packing quantity
20 Mbps to 8 Gbps/ch	1 channel-Bi-direction	90 mm	AYG4V50985	40 pcs. (Inner carton 10 pcs. / tray × 4)
		220 mm	AYG4V52285	

Note) Please contact our sales representative to your request, such as different fiber length.

■ Receptacle

Product type	Part No.	Packing quantity
Receptacle	AXK6S20447M1	20 pcs.
	AXK6S20447M3	200 pcs. (reel)
	AXK6S20447M5	1,500 pcs. (reel)

Active Optical Connector V Series (LC Connector type)

SPECIFICATIONS (1 channel-Bi-direction)

This product has a structure requiring an insertion force for mating, but the mating may come off when an external force is applied to the plug, impact is applied by dropping, or vibration is applied in equipment. Sufficient caution should be used with the equipment to avoid such incidents.

Rated specifications (per channel)

Item	Min.	Typ	Max.	Unit	Condition
Supply voltage	3.2	3.3	3.4	V	Including ripple
Power consumption	—	—	115	mW	—
Transmission rate	0.02	—	8	Gbps	8b/10b coding
Input/output characteristic impedance	80	100	125	Ω	—
Differential input voltage	400	—	1600	mVpp	peak-to-peak
Input common mode voltage	150	—	340	mV	*1
Input total jitter	—	—	0.24	UI	*2
Input rise-time	—	—	0.30	UI	20 to 80%*2 *3
Input fall-time	—	—	0.30	UI	20 to 80%*2 *3
Differential output voltage	300	440	550	mVpp	peak-to-peak*2
Output common mode voltage	150	250	275	mV	*2
Output rise-time	—	—	0.50	UI	20 to 80%*2
Output fall-time	—	—	0.50	UI	20 to 80%*2
Output total jitter	—	—	0.60	UI	Dj+Rjpp*2

*1: When performing AC coupling, the input common mode voltage is 0 to 1.8 V.

*2: Input data pattern is PRBS 2²-1. Rjpp is equivalent to BER 10⁻¹².

*3: When the transmission rate is under 1.5 Gbps, the time is up to 200 ps.

Use conditions

Item	Performance	Remarks
Operating ambient temperature	0 to +70 °C	No icing or condensation.
Storage temperature	-20 to +50 °C (packaged form) -20 to +85 °C (product only)	No icing or condensation.
Electrostatic Discharge	±2 kV	Applied 3 times on the external shell C=100 pF, R=1.5 k Ω C=150 pF, R=330 Ω
Electromagnetic immunity	Conformed to IEC61000-6-2 standard	—
Electromagnetic interference	Conformed to IEC61000-6-4 standard	—
Optical fiber minimum bending radius	15 mm	—
Plug pressing force	Max. 20 N	—
Insertion and removal life of plug	50 times	Repeated insertion and removal cycles of Max. 200 times/hour
Duplex-LC connector specification	Compliant IEC61754-20 standard	—
Connecting relay fiber	OM-3 GI50/125 multimode fiber fiber length: <100 m	In the case of optical active connectors with two adapters connected to both ends of the relay fiber.
Laser Product	Class 1 Laser Product Center wavelength: 850 nm, <2.2 mW	IEC60825-1 Ed. 2:2007 IEC60825-1 Ed. 3:2014 EN60825-1:2014/A11:2021

Materials and specifications

Component name	Materials	Specifications and Remarks
Shell	Copper alloy	Ni plating
Bushing	Elastomer	—
Optical fiber	Silica, UV-cured resin	0.4 × 0.6 mm 2 cores GI multimode fiber core: ϕ 50 μ m, clad: ϕ 125 μ m
Connector	LCP resin, copper alloy	Terminal (Au-plating on Ni-base)
Photoelectric conversion PC board	Glass-fibered epoxy, epoxy resin, etc.	—
IC (LDD, TIA)	CMOS	—
Laser diode	GaAs	—
Photodiode	GaAs	—
Duplex-LC connector	PEI resin, etc.	Compliant IEC61754-20 standard

Active Optical Connector V Series (LC Connector type)

TERMINAL LAYOUT (1 channel-Bi-direction)

■ Electrical connector terminal

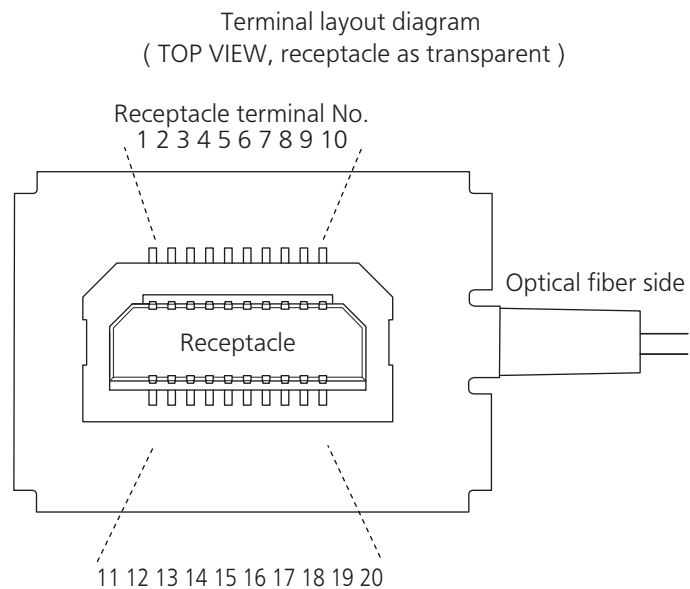

No.	Name
1	Monitor
2	GND
3	Differential output -
4	Differential output +
5	GND
6	Open
7	Open
8	Power Supply
9	Power Supply
10	GND
11	Open
12	GND
13	Differential input -
14	Differential input +
15	GND
16	GND
17	Power Supply
18	Power Supply
19	Power Supply
20	GND

■ Optical connector terminal

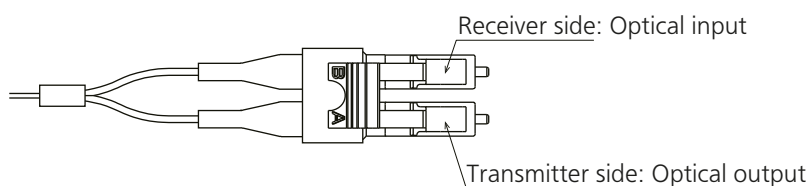

Active Optical Connector V Series (LC Connector type)

DIMENSIONS (Unit: mm)

CAD The CAD data of the products with a " CAD " mark can be downloaded from our Website.

■ Integrated cable and plug

CAD

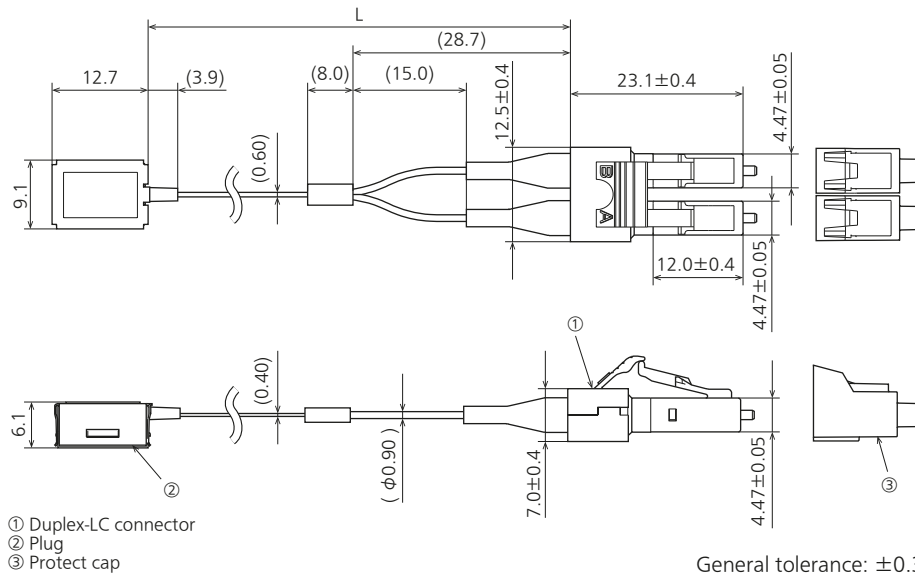
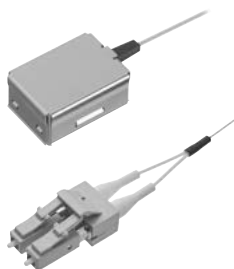

L: Cable length (mm)	Tolerance (mm)
90	± 10
220	± 20

■ Receptacle

CAD

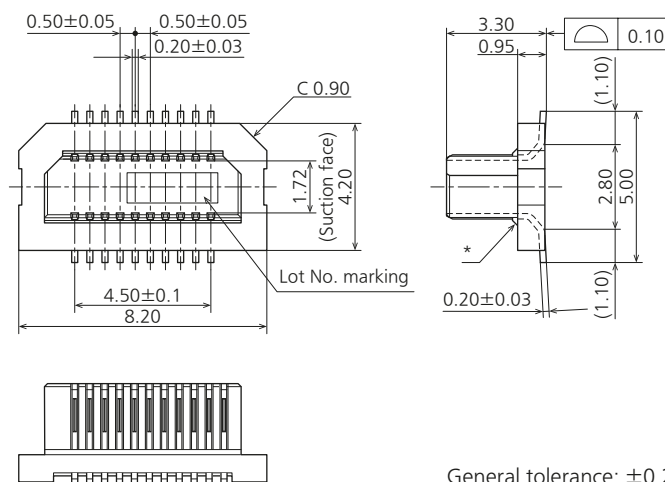
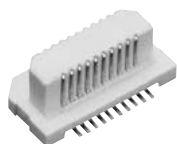

* The terminal close to the portion to be soldered have nickel barriers (except nickel portions).

Active Optical Connector V Series (LC Connector type)

■ Plug and receptacle are mated

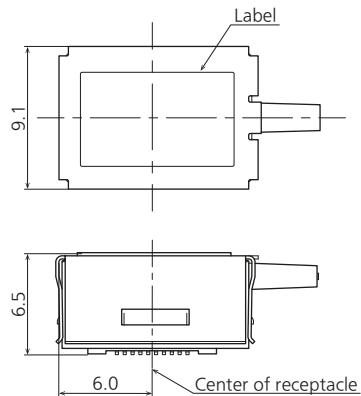

EMBOSED TAPE DIMENSIONS (Unit: mm)

■ Receptacle: Embossed tape packaging

● Specifications for taping

In accordance with JIS C 0806: 1990. However, not applied to the mounting-hole pitch of some connectors.

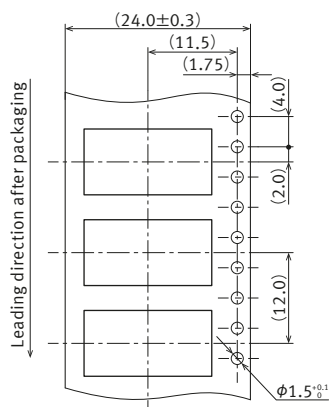

● Specifications for the plastic reel

In accordance with EIAJ ET-7200B.

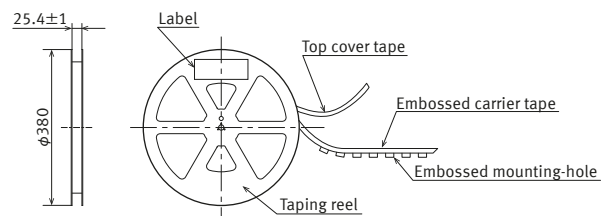

■ Receptacle orientation with respect to embossed tape feeding direction

Direction of tape progress	Type	Receptacle

Active Optical Connector V Series (LC Connector type)

NOTES (Unit: mm)

■ Mounting layout (Component prohibited area)

The shaded area cannot be used for the placement of other components since it is used by the active optical connector. The PC board in the shaded area should be covered with solder resist except for the receptacle's mounting pad.

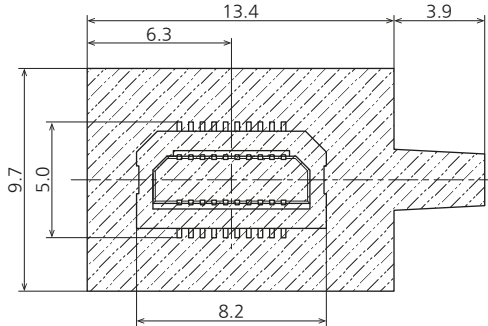

■ Design of PC board patterns

Conduct the recommended foot pattern design, in order to preserve the mechanical strength of terminal solder areas.

■ Recommended PC board and metal mask patterns

Connectors are mounted with high pitch density, intervals of 0.35 mm, 0.4 mm or 0.5 mm. In order to reduce solder and lux rise, solder bridges and other issues make sure the proper levels of solder is used.

The figures are recommended patterns. Please use them as a reference.

● Recommended PC board pattern (TOP VIEW)

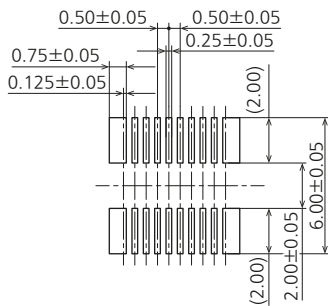

● Recommended metal mask pattern

Metal mask thickness: When 150 μm
(Opening area ratio: 69 %)

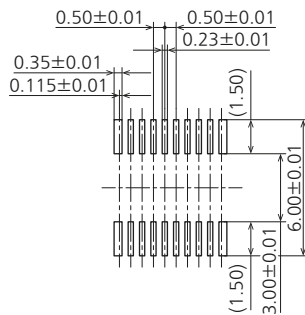

● Recommended metal mask pattern

Metal mask thickness: When 120 μm
(Opening area ratio: 87 %)

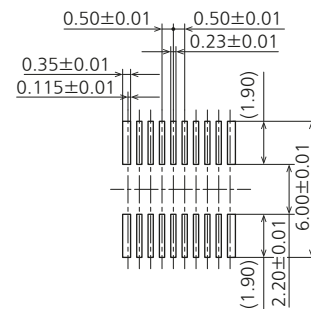

Please refer to "the latest product specifications" when designing your product.
 • Requests to customers:
<https://industrial.panasonic.com/ac/e/salespolicies/>

Notes on Using Active Optical Connector V Series

About safety remarks

■ Observe the following safety remarks to prevent accidents and injuries.

- Do not use these connectors beyond the specification sheets. The usage outside of specified rated current, dielectric strength, and environmental conditions and so on may cause circuitry damage via abnormal heating, smoke, and fire, or eye or skin injuries by laser beam.
- In order to avoid accidents, your thorough specification review is appreciated. Please contact our sales representative if your usage is out of the specifications. Otherwise, Panasonic Industry Co., Ltd. cannot guarantee the quality and reliability.
- We are doing our best to constantly improve the quality and reliability of our products. However, some electric items/components do in fact fail despite our efforts. The durability of products also varies depending on service environments and conditions. Please check your product under actual service conditions before use. If you continue to use a product in a poor condition, items with deteriorated insulation performance may generate abnormal heat or smoke or even ignite. The product's failure or end of service life may cause accidents involving risks to human health, fire, or danger to the public at large. We advise you to apply safety measures and regular maintenance work, such as the use of redundant design, fireproofing, and malfunction-preventing design, to rule out such accidents.
- Caution at the time of a breakage of optical fiber When the optical fiber breaks, immediately shut off the power. This product uses a laser diode (class 1) of non-visible light with oscillation wavelength 850 nm. Do not look into the tip of an optical fiber. The laser beam does not irradiate outside in normal operation, but a breakage of the optical fiber may cause irradiation outside. When the optical fiber breaks, be very careful not to injury at the fiber tip.

● LC connector type

- This product uses a laser diode (IEC60825-1 standard : class 1) of invisible light with oscillation wavelength 850 nm, and laser light is emitted from the tip of Duplex-LC connector, so do not to direct view .

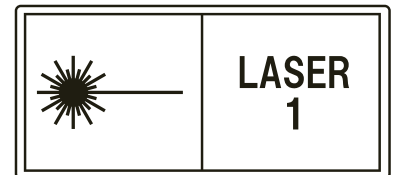
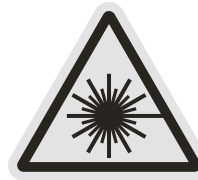

Cautions when using the product

■ Cautions about the operating and storage environments

Please use the product in accordance with the conditions described in these specifications.

The product quality cannot be warranted if the product fails because it is used outside the conditions in these specifications.

- Product failure due to condensation cannot be warranted.
- Use caution for avoiding dust.
- The following environment may deteriorate the product's appearance and affect the product characteristics, and should thus be avoided.
- An environment in which the possible adherence of chemicals such as acid and alkali exists.
- In a gaseous atmosphere of salt, sulfide, etc.

Notes on Using Active Optical Connector V Series

- This product has a structure requiring an insertion force for mating, but the mating may come off when an external force is applied to the plug, impact is applied by dropping, or vibration is applied in equipment. Sufficient caution should be used with the equipment to avoid such incidents.
- The product cannot be used in a movable parts while the optical fiber is bent. Such use may cause deformation of the receptacle or breakage of the optical fiber.
- In order to avoid a load on the plug, Duplex-LC connector, and receptacle applied by the tensile force of the optical fiber, a redundant design is required with respect to the optical fiber length.
- Use caution for wiring the optical fiber to avoid getting entangled or twisting. Also, use adhesive tape for securing the optical fiber for preventing excessive stress caused by vibration and impact.

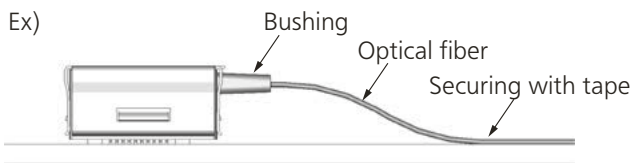

- Insertion and removal operations must be performed while the power is off. Insertion or removal operations in a live condition (with current and voltage) may lead to a breakage.
- Use caution with regard to the generation and handling of static electricity in the operating environment to protect the plug.
- Secure Sufficient insulation distance between the external metal enclosure of the plug and the peripheral components. The plug enclosure, which is connected to the ground, may give rise to danger from a short-circuit. When the product is used in a different environment and in accordance with a method other than described in this document, please contact our sales representative.
- Do not disassemble this product. Doing so will cause malfunction. Also, do not remove the label. The product control number is there.

● LC connector type

- The electrical output characteristics of the receiver side of this product are when this product is used as transmitter side, so we cannot guarantee the electrical output characteristics of the receiver side when using other companies' product as transmitter side. When using other companies' product as transmitter side, use AOC after confirming the performance sufficiently with your product installed AOC.
- This product requires the use of an LC adapter, but we cannot guarantee any problems caused by LC adapter.
- If the tip of the ferrule of the Duplex-LC connector is scratched, it may cause transmission failure. And the lever may be damaged due to a collision. Please use it with the utmost care.
- When connecting Duplex-LC connector, clean the tip of the Duplex-LC connector ferrule with a cleaner to prevent dust, oil, water droplets, etc. from adhering to it. If there is dust or particles on the tip of the ferrule, the transmission characteristics will deteriorate.

- When removing the product from the tray, if it is removed from the plug, there is a concern that it may contact with the connector terminal or the optical fiber may bend less than minimum diameter, so it is recommend removing it from the Duplex-LC connector.

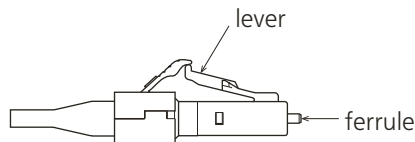

Duplex-LC connector

Plug

Direction of mating and insertion

1 channel-Bi-direction

Mating of the plug and receptacle requires orientation. Align the receptacle shape in the direction of the optical fiber of plug.

2-channel-Uni-direction

The plugs on each end of the optical fiber cable are different (transmission side and receiving side). The cable will not work if inserted incorrectly; therefore, please verify the ends prior to installation. The receiving end plug has an arrow printed on it for the purpose of verification. Please implement a measure to avoid incorrect insertion such as by printing a similar mark on the PC board.

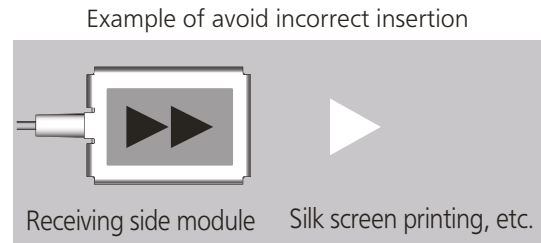

Insertion

Because this product has been designed with a thin mating structure between the plug and receptacle for compact-sizing purposes, excessive tilting during insertion or removal leads to product fracture and separation of the solder section of terminals.

For avoiding breakage of the mating parts, confirm the alignment before mating.

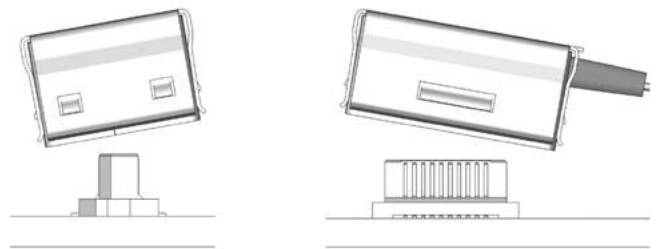

Mating of plug

Make sure the plug is securely inserted into the receptacle. After mating, a gap remains between the PC board and plug.

Avoid applying more pressure, than 20 N.

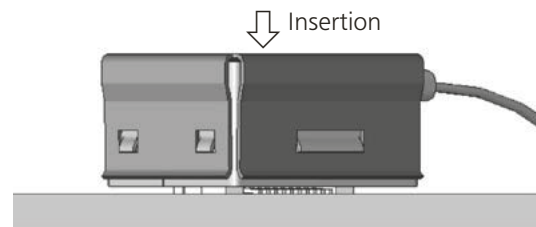

Plug removal

For the removal operation, hold both sides of the metal enclosure and lift the plug upward.

Do not pull the optical fiber and bushing.

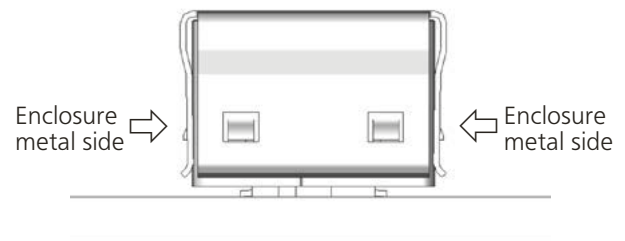

Receptacle

■ Regarding soldering

● Reflow soldering

- Measure the recommended profile temperature for reflow soldering by placing a sensor on the PC board near the connector surface or terminals. (Please refer to the specification for detail because the temperature setting differs by products.)
- As for cream solder printing, screen printing is recommended.
- When setting the screen opening area and PC board foot pattern area, refer the recommended PC board pattern and window size of metal mask on the specification sheet, and make sure that the size of board pattern and metal mask at the base of the terminals are not increased.
- Please pay attentions not to provide too much solder. It makes miss mating because of interference at soldering portion when mating.

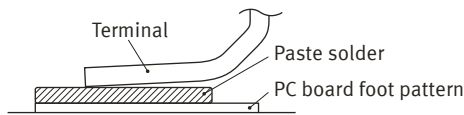

- When mounting on both sides of the PC board and the connector is mounting on the underside, use adhesives or other means to ensure the connector is properly fixed to the PC board. (Double reflow soldering on the same side is possible.)
- The condition of solder or flux rise and wettability varies depending on the type of solder and flux. Solder and flux characteristics should be taken into consideration and also set the reflow temperature and oxygen level.
- Do not use resin-containing solder. Otherwise, the contacts might be firmly fixed.

- Soldering conditions
Please use the reflow temperature profile conditions recommended below for reflow soldering. Please contact our sales representative before using a temperature profile other than that described below (e.g. lead-free solder)

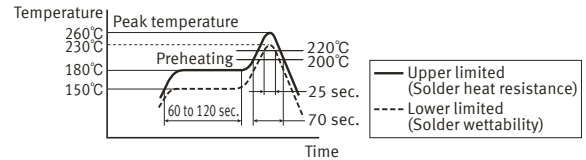

- The temperature profiles given in this catalog are values measured when using the connector on a resin-based PC board. When performed reflow soldering on a metal board (iron, aluminum, etc.) or a metal table to mount on a FPC, make sure there is no deformation or discoloration of the connector before mounting.
- Please contact our sales representative when using a screen-printing thickness other than that recommended.

● Manual soldering

- Set the soldering iron so that the tip temperature is less than that given in the table below.

Table A

Product name	Soldering iron temperature
SMD type connectors	300 °C within 5 sec.
all products	350 °C within 3 sec.

- Do not allow flux to spread onto the connector leads or PC board. This may lead to flux rising up to the connector inside.
- Touch the soldering iron to the foot pattern. After the foot pattern and connector terminal are heated, apply the solder wire so it melts at the end of the connector terminals.

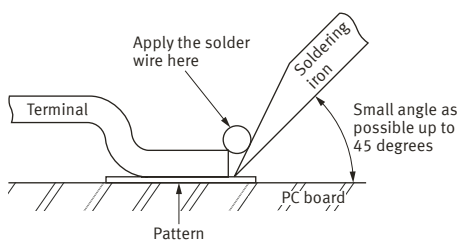

- Be aware that soldering while applying a load on the connector terminals may cause improper operation of the connector.
- Thoroughly clean the soldering iron.
- Flux from the solder wire may get on the contact surfaces during soldering operations. After soldering, carefully check the contact surfaces and clean off any solder before use.
- These connector is low profile type. If too much solder is supplied for hand soldering, It makes miss mating because of interference at soldering portion. Please pay attentions.

● Solder reworking

- Finish reworking in one operation.
- In case of soldering rework of bridges. Do not use supplementary solder flux. Doing so may cause contact problems by flux.
- Keep the soldering iron tip temperature below the temperature given in Table A.

Notes on Using Active Optical Connector V Series

■ Handling single components

- Make sure not to drop or allow parts to fall from work bench.
- Excessive force applied to the terminals could cause warping, come out, or weaken the adhesive strength of the solder. Handle with care.
- Do not insert or remove the connector when it is not soldered.
Forcibly applied external pressure on the terminals can weaken the adherence of the terminals to the molded part or cause the terminals to lose their evenness.

■ Cleaning flux from PC board

There is no need to clean this product.

If cleaning it, pay attention to the following points to prevent the negative effect to the product.

- Keep the cleaning solvent clean and prevent the connector contacts from contamination.
- Some cleaning solvents are strong and they may dissolve the molded part and characters, so pure water passed liquid solvent is recommended.

■ Handling the PC board

● Handling the PC board after mounting the connector

When cutting or bending the PC board after mounting the connector, be careful that the soldered sections are subjected to excessive force.

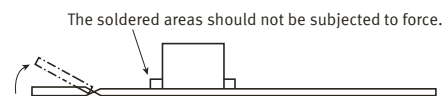

■ Storage of connectors

- To prevent problems from voids or air pockets due to heat of reflow soldering, avoid storing the connectors in areas of high humidity.
- Depending on the connector type, the color of the connector may vary from connector to connector depending on when it is produced. Some connectors may change color slightly if subjected to ultraviolet rays during storage. This is normal and will not affect the operation of the connector.
- When storing the connectors with the PC boards assembled and components already set, be careful not to stack them up so the connectors are subjected to excessive forces.
- Avoid storing the connectors in locations with excessive dust. The dust may accumulate and cause improper connections at the contact surfaces.

■ Other Notes

- Do not remove or insert the electrified connector (in the state of carrying current or applying voltage).
- Dropping of the products or rough mishandling may bend or damage the terminals and possibly hinder proper reflow soldering.
- Before soldering, try not to insert or remove the connector more than absolutely necessary.
- When coating the PC board after soldering the connector to prevent the deterioration of insulation, perform the coating in such a way so that the coating does not get on the connector.
- There may be variations in the colors of products from different production lots. This is normal.
- The connectors are not meant to be used for switching.
- Product failures due to condensation are not covered by warranty.

Please refer to "**the latest product specifications**" when designing your product.

- Requests to customers:
<https://industrial.panasonic.com/ac/e/salespolicies/>

■ Global Sales Network Information: industrial.panasonic.com/ac/e/salesnetwork

Panasonic
INDUSTRY

Panasonic Industry Co., Ltd.

Electromechanical Control Business Division

■ 1006, Oaza Kadoma, Kadoma-shi, Osaka 571-8506, Japan
industrial.panasonic.com/ac/e/