

# ER-V SERIES

Related Information

- General terms and conditions..... F-17
- Selection guide ..... P.1075~
- Glossary of terms..... P.1401
- General precautions ..... P.1405



[panasonic-electric-works.net/sunx](http://panasonic-electric-works.net/sunx)

## A new style of charge removal New ultra-compact, high-performance ionizer!

### Ultra-compact design accurately removes charges of objects even from narrow spaces

The main unit is merely 109 × 27 × 28 mm 4.291 × 1.063 × 1.102 in, so it can easily be combined with other devices and also be installed as an add-on. Furthermore, the high-voltage power supply is built-in, so no extra space is required except for the ionizer itself.

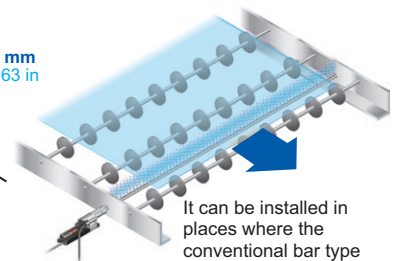

It can be installed in places where the conventional bar type cannot, so it can be placed closer to the object for more accurate charge removal.

### Produces excellent ion balance

The adoption of high-frequency AC method allows extremely stable ion balance to be achieved. Because the ion balance is not affected by the pressure of air supplied or by the setup distance, no troublesome adjustments are required after setup.

#### Charge removal time (typical)

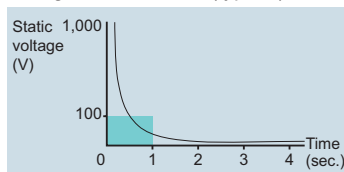

#### Ion balance comparison

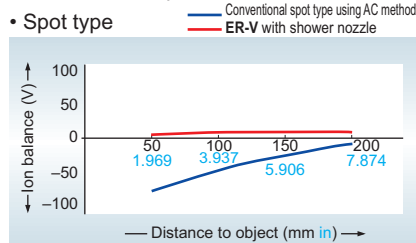

\* Comparison test carried out by Panasonic Electric Works SUNX

#### Bar type

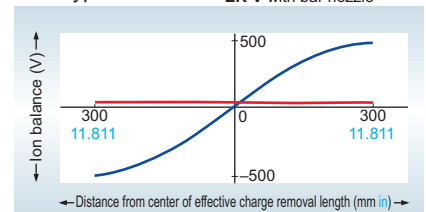

\* Comparison test carried out by Panasonic Electric Works SUNX

- FIBER SENSORS
- LASER SENSORS
- PHOTOELECTRIC SENSORS
- MICRO PHOTOELECTRIC SENSORS
- AREA SENSORS
- LIGHT CURTAINS
- PRESSURE / FLOW SENSORS
- INDUCTIVE PROXIMITY SENSORS
- PARTICULAR USE SENSORS
- SENSOR OPTIONS
- SIMPLE WIRE-SAVING UNITS
- WIRE-SAVING SYSTEMS
- MEASUREMENT SENSORS
- STATIC CONTROL DEVICES
- ENDOSCOPE
- LASER MARKERS
- PLC / TERMINALS
- HUMAN MACHINE INTERFACES
- ENERGY CONSUMPTION VISUALIZATION COMPONENTS
- FA COMPONENTS
- MACHINE VISION SYSTEMS
- UV CURING SYSTEMS

- Selection Guide
- Static Removers
- Cleaning Box
- Pluse Air-gun
- Electrostatic Sensor

- ER-Q
- ER-F
- ER-TF
- ER-VW
- ER-V

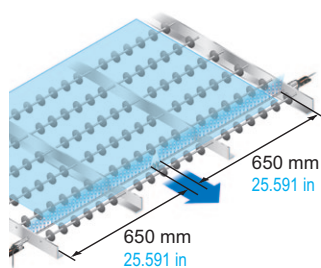
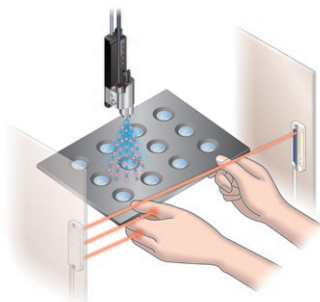
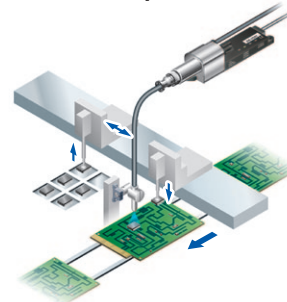
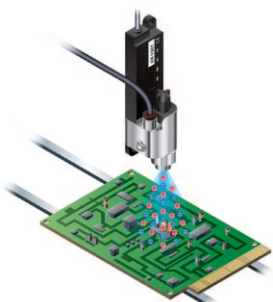
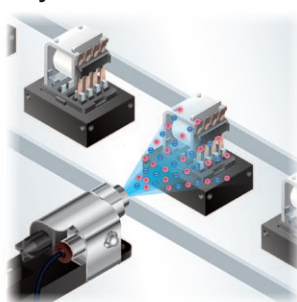
**APPLICATIONS****Charge removal of FPD glass surfaces****Charge removal and dust removal of lenses****Pinpoint charge removal of electronic components****Prevent discharge damage in circuit board LEDs****Charge removal and dust removal of relay and switch contacts****FUNCTIONS****High performance with no controller needed**

A full range of functions have been provided with full consideration given to ease of use in the workplace. No separate controller is needed.

**Discharge halt input**

A signal from an external device can be used to turn discharge ON and OFF. Sensors can be used to detect the objects so that the ion air is generated only when required.

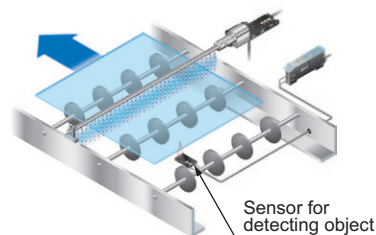
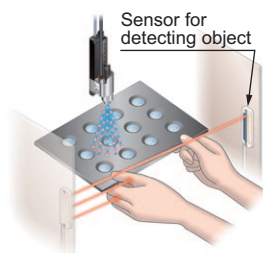
**Discharge indicator**

The discharge ON / OFF status can be checked using an LED display. This lets you avoid problems such as when the power is on but no discharge is occurring.



Lights up when the power is ON (Green LED)

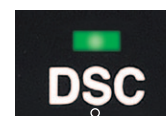

DISCHARGE / Lights up during discharge (Green LED)

FIBER SENSORS

LASER SENSORS

PHOTOELECTRIC SENSORS

MICRO PHOTOELECTRIC SENSORS

AREA SENSORS

LIGHT CURTAINS

PRESSURE / FLOW SENSORS

INDUCTIVE PROXIMITY SENSORS

PARTICULAR USE SENSORS

SENSOR OPTIONS

SIMPLE WIRE-SAVING UNITS

WIRE-SAVING SYSTEMS

MEASUREMENT SENSORS

STATIC CONTROL DEVICES

ENDOSCOPE

LASER MARKERS

PLC / TERMINALS

HUMAN MACHINE INTERFACES

ENERGY CONSUMPTION VISUALIZATION COMPONENTS

FA COMPONENTS

MACHINE VISION SYSTEMS

UV CURING SYSTEMS

Selection Guide

Static Removers

Cleaning Box

Pluse Air-gun

Electrostatic Sensor

**ER-Q****ER-F****ER-TF****ER-VW****ER-V**

- FIBER SENSORS
- LASER SENSORS
- PHOTOELECTRIC SENSORS
- MICRO PHOTOELECTRIC SENSORS
- AREA SENSORS
- LIGHT CURTAINS
- PRESSURE / FLOW SENSORS
- INDUCTIVE PROXIMITY SENSORS
- PARTICULAR USE SENSORS
- SENSOR OPTIONS
- SIMPLE WIRE-SAVING UNITS
- WIRE-SAVING SYSTEMS
- MEASUREMENT SENSORS
- STATIC CONTROL DEVICES
- ENDOSCOPE
- LASER MARKERS
- PLC / TERMINALS
- HUMAN MACHINE INTERFACES
- ENERGY CONSUMPTION VISUALIZATION COMPONENTS
- FA COMPONENTS
- MACHINE VISION SYSTEMS
- UV CURING SYSTEMS
- Selection Guide
- Static Removers
- Cleaning Box
- Pluse Air-gun
- Electrostatic Sensor
- ER-Q
- ER-F
- ER-TF
- ER-VW
- ER-V

**BASIC PERFORMANCE / MAINTENANCE**

**Completely safe design and easy maintenance**

**Easy discharge needle maintenance**

The discharge needle can be removed from the rear of the main unit, so there is no need to remove the nozzle when replacing the needle. Maintenance is easy even when the ion air outlet is located close to the object.

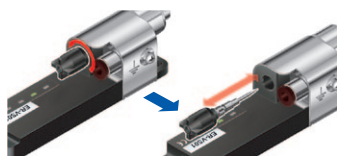

**Low power consumption and low-voltage wiring**

The power supply voltage is 24 V DC, and the power consumed is only 70 mA or less. In addition, safety is enhanced because no high-voltage cables are required.

**Discharge needle is covered by the nozzle**

The discharge needle does not protrude from the main unit, so it cannot be touched by accident. Furthermore, no leaks can occur when it is brought close to metallic objects.

**Safe design**

A “checking function” and an “abnormal discharge monitoring function” are provided to notify the operator when it is time to clean or replace the discharge needle and to prevent discharge problems from occurring. Each function has an LED display to use for checking. The output from each function can also be used to externally monitor the status of the ionizer during operation.



Lights up when the discharge needle is worn or dirty  
(Orange LED)  
[Checking function]  
When lit, the discharge needle may be worn or dirty. Please check it.



Lights up when abnormal discharge is detected  
(Red LED)  
[Abnormal discharge monitoring function]  
When lit, an abnormal discharge has been detected, e.g. due to a foreign substance, and discharge halted in order to maintain safety.



**ORDER GUIDE**

**Ionizer main unit** Nozzle and cable with connector are not supplied with the ionizer main unit. Please order them separately.

Type	Appearance	Charge removal time (±1,000 V → ±100 V)	Ion balance	Model No.
Spot type	 <p>* The photograph shows the unit fitted with a shower nozzle.</p>	1 sec. or less (Note)	±10 V or less (Note)	<b>ER-VS01</b>

Note: A typical sample applied with a supply voltage of 24 V, a distance of 100 mm 3.937 in from the front surface of the air flow outlet and a pressure of 0.25 MPa while the shower nozzle is in use.  
(Measured on a sample left in the atmosphere at a relative humidity of 65 % RH or less for 24 hours or more.)

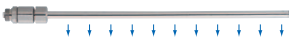
**ORDER GUIDE****Nozzles** Nozzle is not supplied with the ionizer main unit. Please order it separately.

Type	Appearance	Model No.	Description	
Shower nozzle		<b>ER-VAS</b>	Air dispersal type	
Straight bar nozzle		<b>ER-VAB020</b>	Effective charge removal length 200 mm	Straight-line bar containing a series of holes
		<b>ER-VAB032</b>	Effective charge removal length 320 mm	
		<b>ER-VAB065</b>	Effective charge removal length 650 mm	
Shape-preserving tube Joint nozzle		<b>ER-VAJK</b>	Joint nozzle for ionizer main unit and shape-preserving tube	
		<b>ER-VAK10</b>	Tube length 112 mm	Bends easily and holds its bent shape so the tube does not need to be secured (Minimum bending radius: R40 mm R1.575 in)
		<b>ER-VAK30</b>	Tube length 312 mm	
<b>ER-VAK50</b>	Tube length 512 mm			
Conductive tube Joint nozzle		<b>ER-VAJT-64</b>	Joint nozzle for ionizer main unit and conductive tube	
		<b>ER-AT50</b>	Tube length 500 mm	Bends freely, and can be cut to different length (Minimum bending radius: R15 mm R0.591 in)

**Cables with connector** Cable with connector is not supplied with the ionizer main unit. Please order it separately.

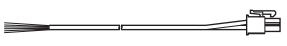
Appearance	Model No.	Description	
	<b>ER-VCCJ2</b>	Length: 2 m	0.15mm <sup>2</sup> 8-core cabtyre cable with connector Cable outer diameter: $\varnothing$ 4.2 mm $\varnothing$ 0.165 in
	<b>ER-VCCJ5</b>	Length: 5 m	
	<b>ER-VCCJ9</b>	Length: 9 m	

**OPTIONS**

Type	Model No.	Description	
Conductive tube holder	<b>ER-ATH</b>	Used to secure conductive tubes	
Mini line filter	<b>ER-AF10</b>	Processed air volume 40 l/min. (ANR)	Removes solid particles such as dirt and dust from air supply • Collected particle dia.: 0.1 $\mu$ m 0.004 mil • Collection efficiency: 99.9 %
	<b>ER-AF20</b>	Processed air volume 80 l/min. (ANR)	
Discharge needle unit	<b>ER-VANT</b>	Unit with tungsten needle (1 set)	

**Conductive tube holder**

- 
- ER-ATH**

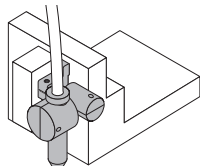
**Mini line filter**

- 
- ER-AF10**
- 
- 
- ER-AF20**

\* The photograph shows **ER-AF10****Discharge needle unit**

- 
- ER-VANT**

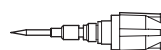
FIBER  
SENSORSLASER  
SENSORSPHOTO-  
ELECTRIC  
SENSORSMICRO  
PHOTO-  
ELECTRIC  
SENSORSAREA  
SENSORSLIGHT  
CURTAINSPRESSURE /  
FLOW  
SENSORSINDUCTIVE  
PROXIMITY  
SENSORSPARTICULAR  
USE  
SENSORSSENSOR  
OPTIONSSIMPLE  
WIRE-SAVING  
UNITSWIRE-SAVING  
SYSTEMSMEASURE-  
MENT  
SENSORSSTATIC  
CONTROL  
DEVICES

ENDOSCOPE

LASER  
MARKERSPLC /  
TERMINALSHUMAN  
MACHINE  
INTERFACESENERGY  
CONSUMPTION  
VISUALIZATION  
COMPONENTSFA  
COMPONENTSMACHINE  
VISION  
SYSTEMSUV  
CURING  
SYSTEMSSelection  
GuideStatic  
RemoversCleaning  
BoxPulse  
Air-gunElectrostatic  
Sensor**ER-Q****ER-F****ER-TF****ER-VW****ER-V**

## SPECIFICATIONS

### Main unit

Item	Type	Spot type
	Model No.	<b>ER-VS01</b>
Charge removal time ( $\pm 1,000$ V $\rightarrow$ $\pm 100$ V)		1 sec. or less (Note 2)
Ion balance		$\pm 10$ V or less (Note 2)
Ozone generation		0.03 ppm or less (Note 3)
Applicable fluid		Air (dried clean air) (Note 4)
Supplied air flow		500 l/min. (ANR) or less (Note 5)
Air pressure range		0.05 to 0.7 MPa (Note 5)
Supply voltage		24 V DC $\pm 10$ %
Current consumption		70 mA or less
Discharge method		High frequency AC method
Discharge output voltage		2,000 V approx.
Check output		NPN open-collector transistor <ul style="list-style-type: none"> <li>Maximum sink current: 50 mA</li> <li>Applied voltage: 30 V DC or less (between check output and 0 V)</li> <li>Residual voltage: 1 V or less (at 50 mA sink current)</li> </ul>
	Output operation	ON when a dirt or worn etc. of the discharge needle is detected for 1.5 sec. or more continuously, OFF when operation is normal (Note 6)
	Short-circuit protection	Incorporated
Error output		NPN open-collector transistor <ul style="list-style-type: none"> <li>Maximum sink current: 50 mA</li> <li>Applied voltage: 30 V DC or less (between error output and 0 V)</li> <li>Residual voltage: 1 V or less (at 50 mA sink current)</li> </ul>
	Output operation	OFF when abnormal discharge is detected, ON when operation is normal
	Short-circuit protection	Incorporated
Discharge halt input		Short-circuit to 0 V: Discharge halt, Open: Discharge allowed (operation start)
Reset input		When abnormal discharge is detected, discharge is halted due to an error. Reset the discharge halt by briefly shorting the power supply's 0 V line.
Indicators	Power	Green LED (lights up when the power is ON)
	Discharge	Green LED (lights up when discharging)
	Check	Orange LED (lights up when the discharge needle is worn or dirty, etc.) (Note 6)
	Error	Red LED (lights up when abnormal discharge is detected)
Environmental resistance	Ambient temperature	0 to +55 °C <b>+32 to +131 °F</b> (No dew condensation)
	Ambient humidity	35 to 65 % RH
	EMC	EN 61000-6-2, EN 61000-6-4
	Vibration resistance	10 to 150 Hz frequency, 0.75 mm <b>0.030 in</b> amplitude in X, Y and Z directions for two hours each
Cable		Cable with a connector, 0.5 m <b>1.640 ft</b> long
Material		Enclosure: PPS, Cover: Stainless steel, Discharge needle: Tungsten
Weight		Net weight: 120 g approx.
Accessory		Connector for wiring: 1 set [Manufactured by Molex: Housing (5557-08R), Terminal (5556TL)]

- Notes: 1) Where measurement conditions have not been specified precisely, the conditions used were an ambient temperature of +20 °C **+68 °F**.  
2) A typical sample applied with a supply voltage of 24 V, a distance of 100 mm **3.937 in** from the front surface of the air flow outlet and a pressure of 0.25 MPa while the shower nozzle is in use. (Measured on a sample left in the atmosphere at a relative humidity of 65 % RH or less for 24 hours or more.)  
3) A typical sample applied with a power voltage of 24 V, a distance of 300 mm **11.811 in** from the front surface of the air flow outlet and a pressure of 0.25 MPa while the shower nozzle is in use.  
4) The air is dried (dew point: equivalent of  $-20$  °C  **$-4$  °F**) and filtered (mesh-size: equivalent of  $0.01$   $\mu$ m **0.0004 mil**) air.  
5) The applicable pressure range depends on the nozzle to be used.  
6) When confirming the check output, carry out discharge for 2 sec. or more.

FIBER SENSORS

LASER SENSORS

PHOTO-ELECTRIC SENSORS

MICRO PHOTO-ELECTRIC SENSORS

AREA SENSORS

LIGHT CURTAINS

PRESSURE / FLOW SENSORS

INDUCTIVE PROXIMITY SENSORS

PARTICULAR USE SENSORS

SENSOR OPTIONS

SIMPLE WIRE-SAVING UNITS

WIRE-SAVING SYSTEMS

MEASUREMENT DEVICES

STATIC CONTROL DEVICES

ENDOSCOPE

LASER MARKERS

PLC / TERMINALS

HUMAN MACHINE INTERFACES

ENERGY CONSUMPTION VISUALIZATION COMPONENTS

FA COMPONENTS

MACHINE VISION SYSTEMS

UV CURING SYSTEMS

Selection Guide

Static Removers

Cleaning Box

Pluse Air-gun

Electrostatic Sensor

ER-Q

ER-F

ER-TF

ER-VV

ER-V



**SPECIFICATIONS**

**Nozzles / Tubes**

Type	Shower nozzle	Straight bar nozzle 200 mm 7.874 in	Straight bar nozzle 320 mm 12.598 in	Straight bar nozzle 650 mm 25.591 in	
Item	Model No.	<b>ER-VAS</b>	<b>ER-VAB020</b>	<b>ER-VAB032</b>	<b>ER-VAB065</b>
Supplied air pressure range	0.05 to 0.40 MPa				
Charge removal range	—	200 mm 7.874 in	320 mm 12.598 in	650 mm 25.591 in	
Material	Stainless steel				
Accessories	Attachment and insulation pipe: 1 pc. each	Attachment and insulation pipe: 1 pc. each, Straight bar nozzle holder: 1 set			

Type	Shape-preserving tube joint nozzle	Conductive tube joint nozzle	
Item	Model No.	<b>ER-VAJK</b>	<b>ER-VAJT-64</b>
Air pressure range	0.02 to 0.5 MPa	0.02 to 0.7 MPa (Maximum applied pressure depends on the tube length. Refer to the following figure)	
Material	Stainless steel	Stainless steel	
Consumption air flow	30 to 250 l/min. (ANR)	20 to 160 l/min. (ANR) (at applied pressure of 0.02 to 0.7 MPa)	
Accessories	Attachment (White): 1pc., Insulation pipe: 1pc.	Attachment (White): 1pc., Insulation pipe: 1pc.	

Type	Shape-preserving tube			Conductive tube
Item	Model No.	<b>ER-VAK10</b>	<b>ER-VAK30</b>	<b>ER-AT50</b>
Tube length	112 mm 4.409 in	312 mm 12.283 in	512 mm 20.157 in	500 mm 19.685 in
Material	Tube interior: Aluminum, Tube sheath: High-density polyethylene, Terminal cap: Stainless steel			Urethane
Air pressure range	0.02 to 0.5 MPa			0.02 to 0.7 MPa
Minimum bending radius	R40 mm R1.575 in or more			R15 mm R0.591 in or more

Note: Where measurement conditions have not been specified precisely, the conditions used were an ambient temperature of +20 °C +68 °F.

**• Correlation between tube length and maximum applied pressure**

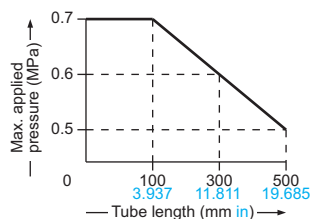

**I/O CIRCUIT AND WIRING DIAGRAMS**

**ER-VS01**

**I/O circuit diagram**

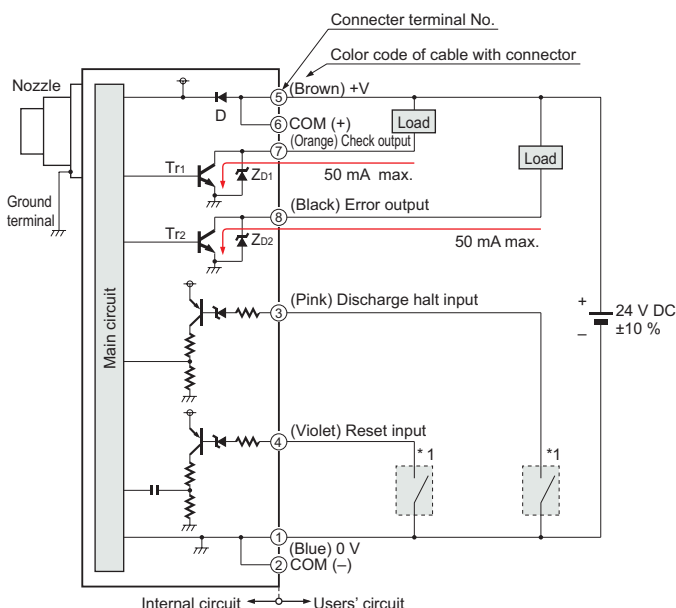

Symbols ... D: Reverse supply polarity protection diode  
 ZD1, ZD2: Surge absorption zener diode  
 Tr1, Tr2: NPN output transistor

**Connector terminal arrangement**

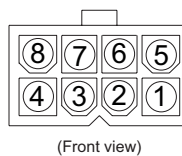

Terminal No.	Description	Color code of cable with connector
①	0 V	Blue
②	COM (-)	—
③	Discharge halt input	Pink
④	Reset input	Violet
⑤	24 V	Brown
⑥	COM (+)	—
⑦	Check output	Orange
⑧	Error output	Black

Note: ① and ② are short-circuited at the connector side.  
 ⑤ and ⑥ are short-circuited at the connector side.

\* 1

Non-voltage contact or NPN open-collector transistor

- Discharge halt input  
 Low (0 V): Discharge halt  
 High (Open): Discharge allowed (Operation starts)
- Reset input  
 When abnormal discharge is detected, discharge is halted due to an error.  
 Reset the discharge halt by briefly shorting the power supply's 0 V line.

FIBER SENSORS  
 LASER SENSORS  
 PHOTO-ELECTRIC SENSORS  
 MICRO PHOTO-ELECTRIC SENSORS  
 AREA SENSORS  
 LIGHT CURTAINS  
 PRESSURE / FLOW SENSORS  
 INDUCTIVE PROXIMITY SENSORS  
 PARTICULAR USE SENSORS  
 SENSOR OPTIONS  
 SIMPLE WIRE-SAVING UNITS  
 WIRE-SAVING SYSTEMS  
 MEASUREMENT SENSORS  
 STATIC CONTROL DEVICES  
 ENDSCOPE  
 LASER MARKERS  
 PLC / TERMINALS  
 HUMAN MACHINE INTERFACES  
 ENERGY CONSUMPTION VISUALIZATION COMPONENTS  
 FA COMPONENTS  
 MACHINE VISION SYSTEMS  
 UV CURING SYSTEMS

Selection Guide  
 Static Removers  
 Cleaning Box  
 Pluse Air-gun  
 Electrostatic Sensor

**ER-Q**  
**ER-F**  
**ER-TF**  
**ER-VW**  
**ER-V**

**CHARGE REMOVAL CHARACTERISTICS (TYPICAL)**

Please contact our office for details on data that is not listed here.

Measured using a 150 mm × 150 mm 5.906 in × 5.906 in CPM (charge plate monitor). (At center of CPM)

**Common to all nozzles**

**Air flow**

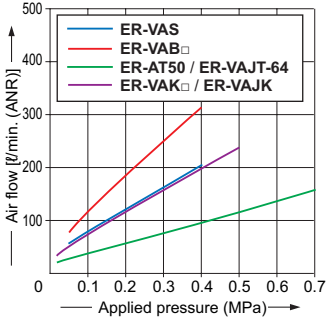

**Correlation between charge removal distance and ion balance (Typical: ER-VAS)**

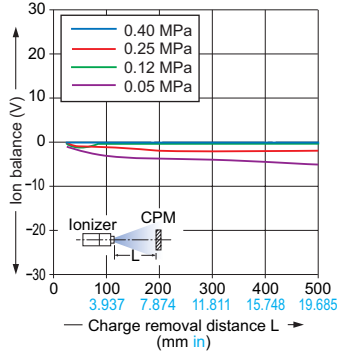

**ER-VAS**

**Shower nozzle**

**Correlation between charge removal distance and charge removal time**

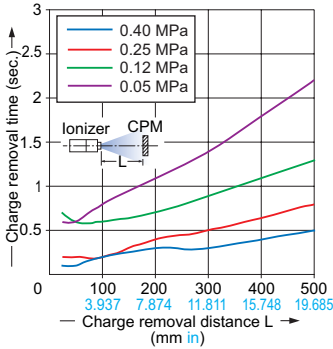

**Charge removal field (0.40 MPa)**

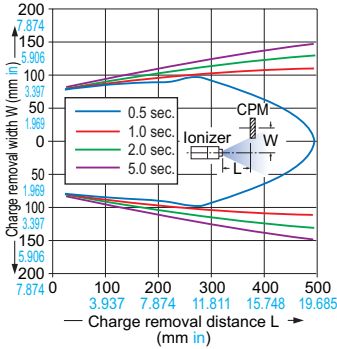

**ER-VAB020**

**Straight bar nozzle**

**Correlation between charge removal distance and charge removal time**

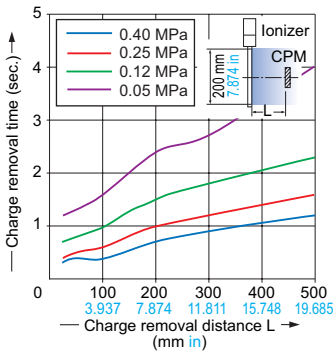

**Charge removal field (0.40 MPa)**

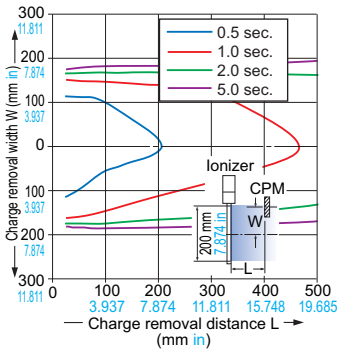

**ER-VAB032**

**Straight bar nozzle**

**Correlation between charge removal distance and charge removal time**

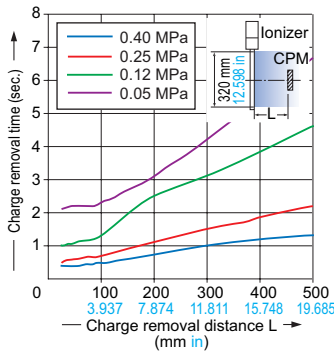

**Charge removal field (0.40 MPa)**

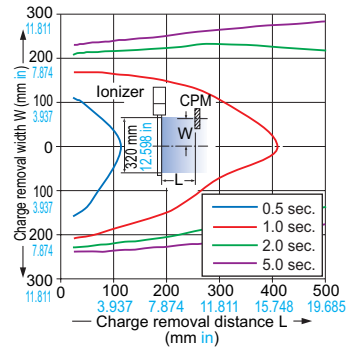

**ER-Q**

**ER-VAB065**

**Straight bar nozzle**

**Correlation between charge removal distance and charge removal time**

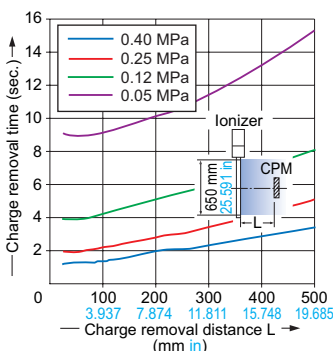

**Charge removal field (0.40 MPa)**

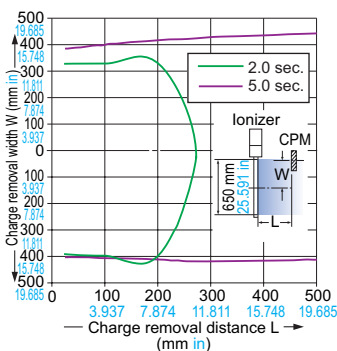

**ER-F**

**ER-TF**

**ER-VV**

**ER-V**

- FIBER SENSORS
- LASER SENSORS
- PHOTO-ELECTRIC SENSORS
- MICRO PHOTO-ELECTRIC SENSORS
- AREA SENSORS
- LIGHT CURTAINS
- PRESSURE / FLOW SENSORS
- INDUCTIVE PROXIMITY SENSORS
- PARTICULAR USE SENSORS
- SENSOR OPTIONS
- SIMPLE WIRE-SAVING UNITS
- WIRE-SAVING SYSTEMS
- MEASUREMENT SENSORS
- STATIC CONTROL DEVICES
- ENDSCOPE
- LASER MARKERS
- PLC / TERMINALS
- HUMAN MACHINE INTERFACES
- ENERGY CONSUMPTION VISUALIZATION COMPONENTS
- FA COMPONENTS
- MACHINE VISION SYSTEMS
- UV CURING SYSTEMS
- Selection Guide
- Static Removers
- Cleaning Box
- Pluse Air-gun
- Electrostatic Sensor

**CHARGE REMOVAL CHARACTERISTICS (TYPICAL)**

Please contact our office for details on data that is not listed here.

**ER-VAJK ER-VAK10** Shape-preserving tube joint nozzle, Shape-preserving tube

Correlation between charge removal distance and charge removal time

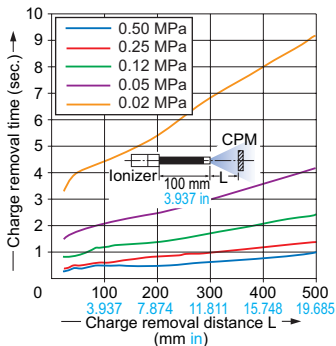

Charge removal field (0.50 MPa)

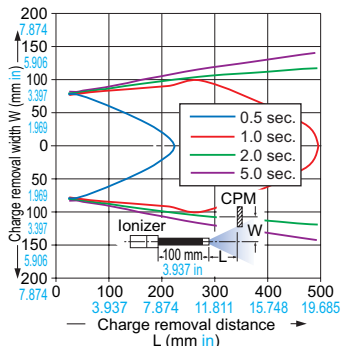

**ER-VAJK ER-VAK30** Shape-preserving tube joint nozzle, Shape-preserving tube

Correlation between charge removal distance and charge removal time

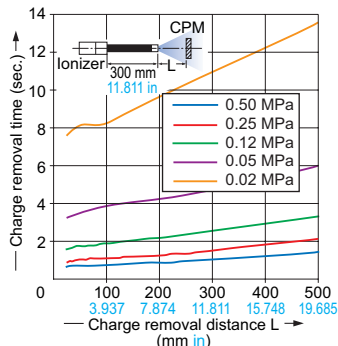

Charge removal field (0.50 MPa)

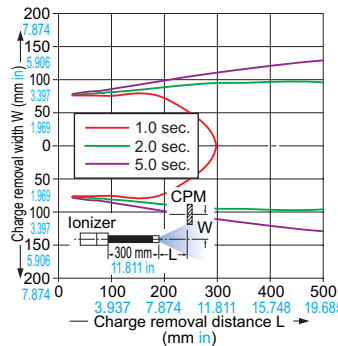

**ER-VAJK ER-VAK50** Shape-preserving tube joint nozzle, Shape-preserving tube

Correlation between charge removal distance and charge removal time

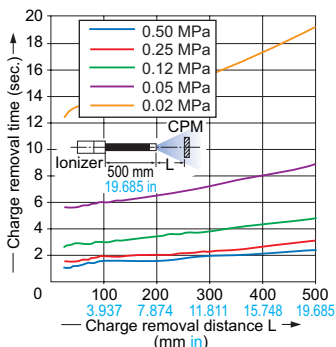

Charge removal field (0.50 MPa)

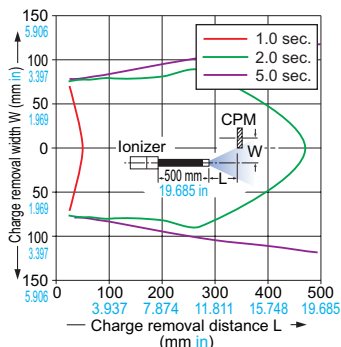

**ER-VAJT-64 ER-AT50**

Conductive tube joint nozzle, Conductive tube

Correlation between charge removal distance and charge removal time (Tube length 100 mm 3.937 in)

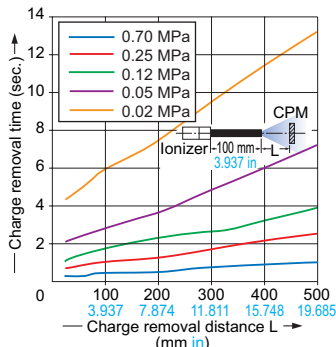

Correlation between charge removal distance and charge removal time (Tube length 300 mm 11.811 in)

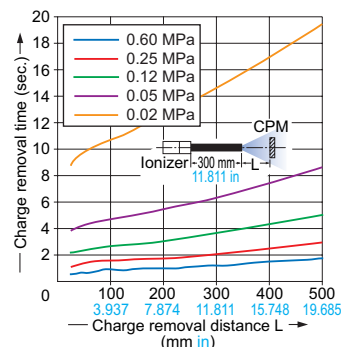

Correlation between charge removal distance and charge removal time (Tube length 500 mm 19.685 in)

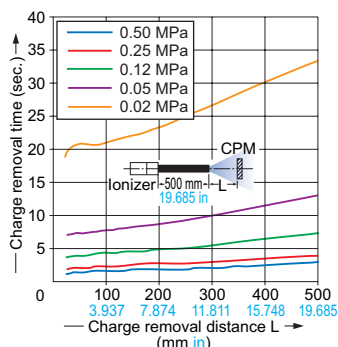

Correlation between tube length and max. applied pressure

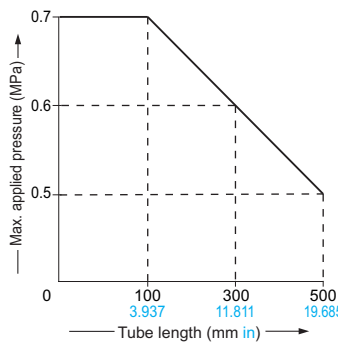

Charge removal field (0.70 MPa) (Tube length 100 mm 3.937 in)

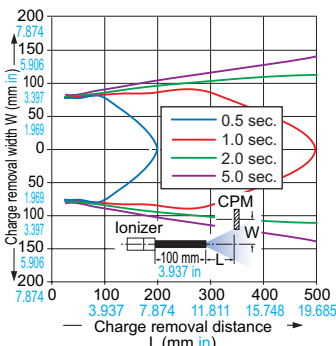

Charge removal field (0.60 MPa) (Tube length 300 mm 11.811 in)

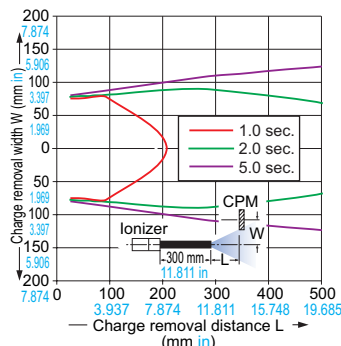

Charge removal field (0.50 MPa) (Tube length 500 mm 19.685 in)

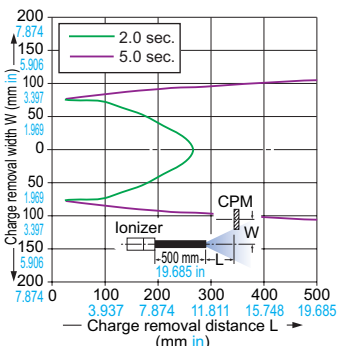

- FIBER SENSORS
- LASER SENSORS
- PHOTO-ELECTRIC SENSORS
- MICRO PHOTO-ELECTRIC SENSORS
- AREA SENSORS
- LIGHT CURTAINS
- PRESSURE / FLOW SENSORS
- INDUCTIVE PROXIMITY SENSORS
- PARTICULAR USE SENSORS
- SENSOR OPTIONS
- SIMPLE WIRE-SAVING UNITS
- WIRE-SAVING SYSTEMS
- MEASUREMENT SENSORS
- STATIC CONTROL DEVICES
- ENDOSCOPE
- LASER MARKERS
- PLC / TERMINALS
- HUMAN MACHINE INTERFACES
- ENERGY CONSUMPTION VISUALIZATION COMPONENTS
- FA COMPONENTS
- MACHINE VISION SYSTEMS
- UV CURING SYSTEMS
- Selection Guide
- Static Removers
- Cleaning Box
- Pluse Air-gun
- Electrostatic Sensor
- ER-Q**
- ER-F**
- ER-TF**
- ER-VW**
- ER-V**



## PRECAUTIONS FOR PROPER USE

Refer to General precautions.



This product is designed to remove static electricity for industrial use. It is not intended to be used to prevent accidents, either to humans or properties, or for safety maintenance.

### Mounting

- When this product is mounted in a housing, use M4 screws (please arrange separately).
- If more than 2 units are mounted close together, keep 5 mm **0.197 in** or more between them. If used at distances within 5 mm **0.197 in**, performance may be affected.
- Ensure sufficient space for daily check and maintenance.
- Make sure to ground this product. If the grounding is not proper, charge removal may be impaired. (Direct earth or power supply common earth)
- If an electrostatically charged object is in contact with or near another object, charge removal may be impaired. Install this product such that ions are blown against the electrostatically charged object, when the object is at a distance from other objects or is floating in mid-air.

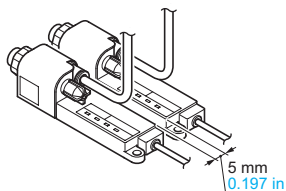

### Nozzle



- The ionizer main unit cannot be used by itself. Always be sure to attach a nozzle (optional) before use.
- Never modify the optional nozzle. If the modified nozzle is used, the pressure inside of the nozzle increases, and the check output works as the monitoring function of the discharge part is activated.
- For the details of the optional nozzle, refer to the instruction manual enclosed with the nozzle.

- There are Select the suitable model for your application.
- Appropriate air pressure for each nozzle should be used.
- To fit the air nozzle, screw it to the product till it stops.

### Piping

- The outer diameter of the air tube for the air inlet of this product should be  $\varnothing 6$  mm  **$\varnothing 0.236$  in**.
- Make sure that clean air (air containing no water, no oil and no dust) should be supplied.

### Wiring



- Make sure that the power supply is off while wiring. Otherwise, there is a danger of electric shock.

- After wiring, reconfirm the wiring connections before switching on the power supply.
- Note, wrong wiring will damage the product.
- Verify that the supply voltage variation is within the rating.
- Do not run the wires together with high-voltage lines or power lines or put them in the same raceway. This can cause malfunction due to induction.

### Maintenance



- Always be sure that the power supply and the air supply are both turned off before inspection and cleaning.
- Since the tip of the discharge needle is pointed, take sufficient care when cleaning.

- The charge removal effect will deteriorate if dirt is stuck to the tip of the discharge needle. If a check signal is output, clean the discharge needle.
- Clean the discharge needle periodically even if no check signal is output.
- The discharge needle's life-time is approximately 10,000 hours. Please change it after this period has elapsed. Use only **ER-V** discharge needle **ER-VANT** (optional).
- If a check signal is output even after the discharge needle has been cleaned, replace the discharge needle.
- If an error signal is output, it may indicate an abnormal discharge.

Check the following points:

- Make sure that the supply voltage is within the tolerance as per specifications.
  - Make sure that the discharge needle unit is mounted correctly on the main unit. Check the tip of the discharge needle for a chip or contamination. If the discharge needle is chipped or dirty, clean it or replace it with a new needle.
  - Check that no foreign materials are inside the nozzle, that the nozzle is mounted correctly and that the ionizer is set up correctly.
  - Make sure that the ground terminal is connected completely.
- To reset the ionizer after an error signal has been output, input a reset signal.

#### Procedure for cleaning

- Check that the power supply and the air supply are both turned off.
- Remove the discharge needle from the rear of the main unit.
- Remove the dirt on and around the discharge needle with a cotton swab soaked in alcohol.
- Check the discharge needle once more to make sure it is free from foreign particles such as thread scraps.
- After cleaning the discharge needle, mount it.

#### Replacing the discharge needle

- Check that the power supply and the air supply are both turned off.
- Remove the discharge needle from the rear of the main unit.
- After checking there is no contamination on or around the new discharge needle, mount the nozzle.

FIBER SENSORS

LASER SENSORS

PHOTO-ELECTRIC SENSORS  
MICRO PHOTO-ELECTRIC SENSORS

AREA SENSORS

LIGHT CURTAINS

PRESSURE / FLOW SENSORS

INDUCTIVE PROXIMITY SENSORS

PARTICULAR USE SENSORS

SENSOR OPTIONS

SIMPLE WIRE-SAVING UNITS

WIRE-SAVING SYSTEMS

MEASUREMENT SENSORS

STATIC CONTROL DEVICES

ENDOSCOPE

LASER MARKERS

PLC / TERMINALS

HUMAN MACHINE INTERFACES

ENERGY CONSUMPTION VISUALIZATION COMPONENTS

FA COMPONENTS

MACHINE VISION SYSTEMS

UV CURING SYSTEMS

Selection Guide

Static Removers

Cleaning Box

Pluse Air-gun

Electrostatic Sensor

ER-Q

ER-F

ER-TF

ER-VW

ER-V

**PRECAUTIONS FOR PROPER USE**

Refer to General precautions.

**Others**

- Make sure to use the DC power supply insulated by an isolation transformer, etc. for this product.
- If an auto-transformer, etc. (single winding transformer) is used, this product or the power supply may be damaged due to short-circuit.

- Do not use this product beyond its rated specifications. Doing so can cause product breakdown, non-function, or damage. Furthermore, it will also cause a marked reduction in product life.
- Never disassemble, repair, modify, or misuse this product, as this can cause an accident or malfunction.
- Do not throw this product into fire: it may explode or generate poisonous gas.
- Since high voltage is applied to the discharge needle, keep your fingers, body, metal, e.g. wires or tools, etc., away from the needle. If you fail to keep away from the needle, electric shock or malfunction may be the result.
- This product is not explosion-proof. Do not use it in places where combustible or flammable material is present. There is a danger of catching fire.
- Since this product emits ozone into the atmosphere, circulate air to prevent foul smells. If ozone lingers for long periods, metals, etc. may oxidize / decay. Furthermore, do not try to confirm that foul smells are caused by the ozone by drawing your face near the

nozzle outlet and air outlet: you may hurt your nose, throat, etc.

- Do not use this product in steamy or dusty places, in places where water and oil splash, or where spatter flies when welding.
- If the power supply is switched on immediately after being switched off, fault output may be generated. After the power supply is switched off, wait at least 1 sec. before switching it on again.
- Confirm the wiring and piping state before supplying power or air. Wrong wiring and piping may cause malfunction.
- Do not use this product for any purpose other than charge removal.
- When this product is no longer usable or required, dispose of properly as industrial waste.
- If the air supplied to this product is turned ON / OFF by a solenoid valve, for example, make sure to turn the discharge halt input ON / OFF simultaneously.
- Use air (dry, clean air) for the fluid. Any fluid other than air (dry, clean air) or even air containing corrosive gas may cause an accident or malfunction.
- Do not use air that contains foreign particles, e.g. carbon dust, dust, water or oil. Since these substances may cause electric shock or malfunction, take appropriate countermeasures, e.g. install an airfilter, air-drier, etc.

**Mini Line Filter****Specifications**

Item	Designation Model No.	Mini line filter	
		ER-AF10	ER-AF20
Applicable ionizer		ER-VS01, ER-SP□	
Applicable fluid		Air	
Pipe connection port		R 1/8, Rc 1/8	R 1/4, Rc 1/4
Collected particle dia.		0.1 μm <b>0.0004 mil</b>	
Collection efficiency		99.9 %	
Processed air volume (Note)		40 l/min. (ANR)	80 l/min. (ANR)
Membrane area		29.9 cm <sup>2</sup>	68.7 cm <sup>2</sup>
Max. operating pressure		0.97 MPa	
Warranted withstand pressure		1.47 MPa	
Ambient temperature		+5 to +45 °C <b>+41 to +113 °F</b>	
Material		Main body: Aluminum alloy (Almite processed) Element: Porous, hollow fiber membranane	
Net Weight		11 g approx.	18 g approx.

Note: Maximum processed air volume that the filter performance can be maintained.  
Approximately 0.1 MPa of pressure drop occurs with the max. processed air volume.

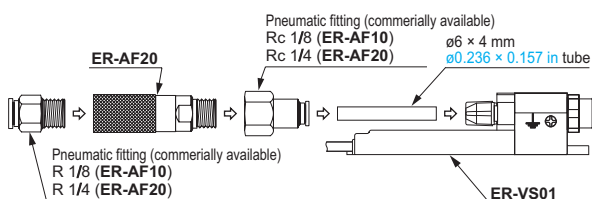
**Piping****<Mounting example of ER-AF20 + ER-VS01>**

- Fit the pneumatic fittings on the both sides of this product to connect to the pneumatic tube, as the figure shown above.

Notes: 1) Since this product is made by aluminum alloy, make sure that excessive force is not applied.  
2) This product is for removal of solid particles. Remove water, oil, etc., in the primary pressure side.

**Cautions**

- Before the piping, make sure to sufficiently carry out internal flashing (blowing of compressed air) of the pipe. If scrap or sealing tape, generated during work, or rust, etc., gets inserted, it will cause clogging.
- Use air (dry, clean air) which does not contain water, oil, etc. Water or oil will cause clogging or reduction in performance.
- Do not use with a fluid or in an environment containing the following substances:
  - Organic solvents · Ester phosphate type hydraulic fluid
  - Sulfuric acid gas · Chlorine gas · Acids
- Do not use at a place where the temperature exceeds the rated ambient temperature range.
- Do not use at a pressure exceeding the rated maximum operating pressure.
- This product is for industrial use. Do not use it in equipment affecting human life.
- Make sure that excessive external force is not applied to this product.
- Never disassemble or modify this product.
- Do not expose this product to ultraviolet light, wind or rain.
- When disposing this product, dispose it as industrial waste.

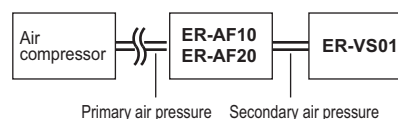
**Pressure drop**

- When the mini line filter (ER-AF10/AF20) is fitted, a pressure drop occurs. Adjust the primary air pressure so that the secondary air pressure is within the air pressure range of the ionizer. (Take care that the air pressure range differs depending on the nozzle. Furthermore, in case the filter is used with the max. processed air volume, approximately 0.1 MPa of pressure drop occurs.)
- Take care that if the air more than the specified processed air volume is applied, the efficiency will deteriorate.

FIBER SENSORS

LASER SENSORS

PHOTO-ELECTRIC SENSORS

MICRO PHOTO-ELECTRIC SENSORS

AREA SENSORS

LIGHT CURTAINS

PRESSURE / FLOW SENSORS

INDUCTIVE PROXIMITY SENSORS

PARTICULAR USE SENSORS

SENSOR OPTIONS

SIMPLE WIRE-SAVING UNITS

WIRE-SAVING SYSTEMS

MEASURE-MENT SENSORS

STATIC CONTROL DEVICES

ENDOSCOPE

LASER MARKERS

PLC / TERMINALS

HUMAN MACHINE INTERFACES

ENERGY CONSUMPTION VISUALIZATION COMPONENTS

FA COMPONENTS

MACHINE VISION SYSTEMS

UV CURING SYSTEMS

Selection Guide

Static Removers

Cleaning Box

Pluse Air-gun

Electrostatic Sensor

ER-Q

ER-F

ER-TF

ER-VW

ER-V

### DIMENSIONS (Unit: mm in)

The CAD data in the dimensions can be downloaded from our website.

#### ER-VS01

Ionizer main unit

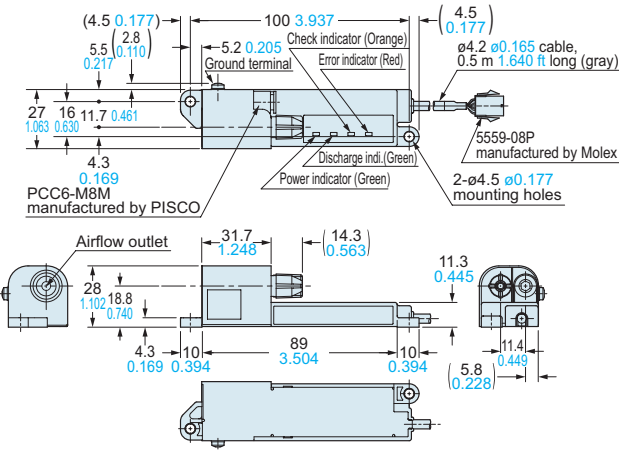

#### Mounting drawing with shower nozzle (ER-VAS, Optional)

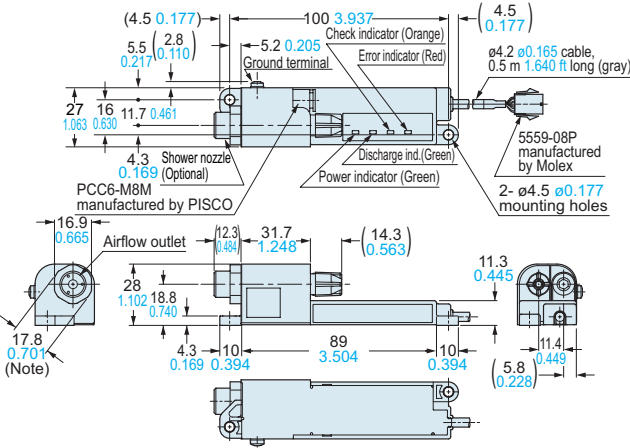

Note: Hexagonal clamping part is 16.9 mm 0.665 in.

#### Mounting drawing with straight bar nozzle (ER-VAB, Optional)

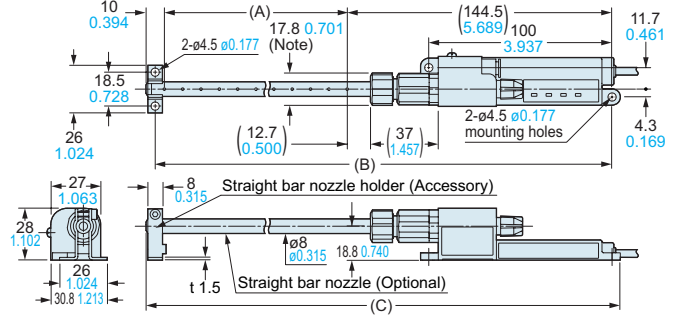

Model No.	A	B	C
ER-VAB020	200 7.874	349.5 13.760	359 14.134
ER-VAB032	320 12.598	469.5 18.484	479 18.858
ER-VAB065	650 25.591	799.5 31.476	809 31.850

Note: Hexagonal clamping part is 16.9 mm 0.665 in.

#### Mounting drawing with shape-preserving tube and joint nozzle (ER-VAK, ER-VAJK, Optional)

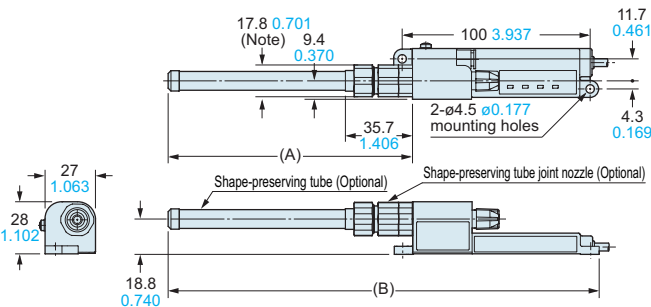

Model No.	A	B
ER-VAK10	130 5.118	229.3 9.028
ER-VAK30	330 12.992	429.3 16.902
ER-VAK50	530 20.866	629.3 24.776

Note: Hexagonal clamping part is 16.9 mm 0.665 in.

#### Mounting drawing with conductive tube joint nozzle (ER-VAJT-64, Optional)

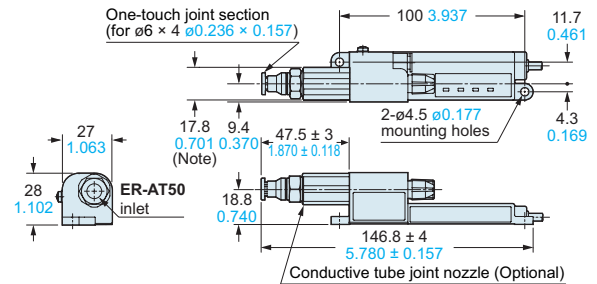

Note: Hexagonal clamping part is 16.9 mm 0.665 in.

- FIBER SENSORS
- LASER SENSORS
- PHOTO-ELECTRIC SENSORS
- MICRO PHOTO-ELECTRIC SENSORS
- AREA SENSORS
- LIGHT CURTAINS
- PRESSURE / FLOW SENSORS
- INDUCTIVE PROXIMITY SENSORS
- PARTICULAR USE SENSORS
- SENSOR OPTIONS
- SIMPLE WIRE-SAVING UNITS
- WIRE-SAVING SYSTEMS
- MEASUREMENT SENSORS
- STATIC CONTROL DEVICES
- ENDOSCOPE
- LASER MARKERS
- PLC / TERMINALS
- HUMAN MACHINE INTERFACES
- ENERGY CONSUMPTION VISUALIZATION COMPONENTS
- FA COMPONENTS
- MACHINE VISION SYSTEMS
- UV CURING SYSTEMS
- Selection Guide
- Static Removers
- Cleaning Box
- Pluse Air-gun
- Electrostatic Sensor
- ER-Q
- ER-F
- ER-TF
- ER-VW
- ER-V

**DIMENSIONS (Unit: mm in)**

**ER-VAJK** Shape-preserving tube joint nozzle (Optional)

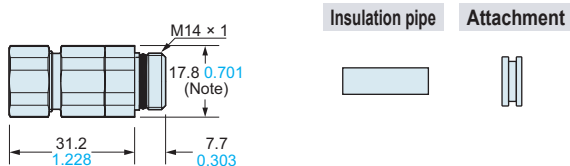

Note: Hexagonal clamping part is 16.9 mm 0.665 in.

**ER-VAJT-64** Conductive tube joint nozzle (Optional)

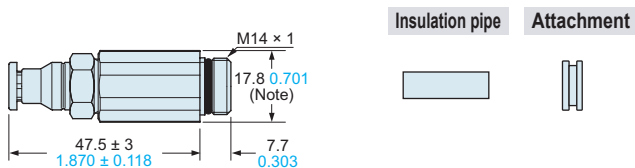

Note: Hexagonal clamping part is 16.9 mm 0.665 in.

**ER-ATH** Conductive tube holder (Optional)

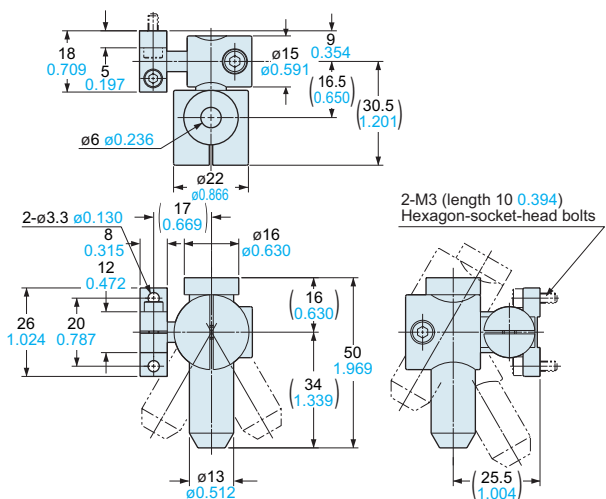

The CAD data in the dimensions can be downloaded from our website.

**ER-VAK□** Shape-preserving tube (Optional)

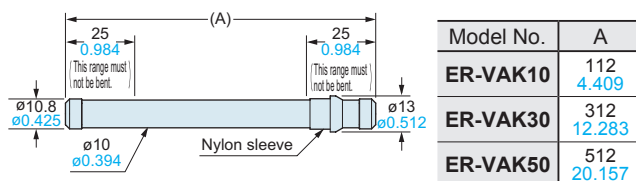

**ER-AT50** Conductive tube (Optional)

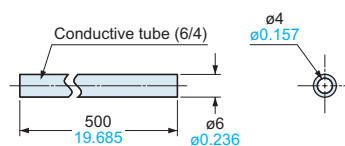

**ER-AF10** Mini line filter (Optional)

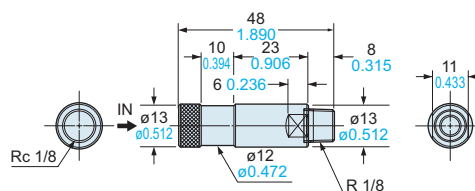

**ER-AF20** Mini line filter (Optional)

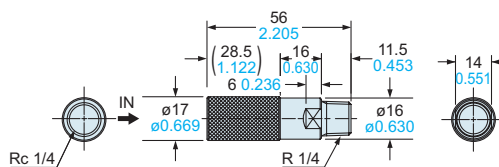

FIBER SENSORS

LASER SENSORS

PHOTO-ELECTRIC SENSORS

MICRO PHOTO-ELECTRIC SENSORS

AREA SENSORS

LIGHT CURTAINS

PRESSURE / FLOW SENSORS

INDUCTIVE PROXIMITY SENSORS

PARTICULAR USE SENSORS

SENSOR OPTIONS

SMILE WIRE-SAVING UNITS

WIRE-SAVING SYSTEMS

MEASUREMENT SENSORS

STATIC CONTROL DEVICES

ENDOSCOPE

LASER MARKERS

PLC / TERMINALS

HUMAN MACHINE INTERFACES

ENERGY CONSUMPTION VISUALIZATION COMPONENTS

FA COMPONENTS

MACHINE VISION SYSTEMS

UV CURING SYSTEMS

Selection Guide

Static Removers

Cleaning Box

Pluse Air-gun

Electrostatic Sensor

**ER-Q**

**ER-F**

**ER-TF**

**ER-VW**

**ER-V**