

TOSHIBA

Variable Speed Drive

TOSVERT™ VF-nC3



Transistor Inverter TOSVERT™ VF-nC3

Triple
Simple
Features

Operation

Set Up

Installation



Simple Set Up

Easy to set parameters

- Showing most frequently used parameters in easy mode.**
EASY key allows you switch between Easy mode and Standard mode.
Easy mode: Scrolls through a list of only seven parameters. You can optionally add up to 24 parameters to the list.
Standard mode: Rotates through all parameters.
- Guides you step by step through parameters you need to set up.**
Since the guidance feature shows one parameter at a time according to the selected function, you can interactively edit its value. Auto-guidance function is available with motor parameter setup, preset speed selection and analog signal control, etc.
- Searching for a history of changes in history function.**
History function makes change of parameter setting easily when some parameters are repeatedly set by the trial run and the adjustment, etc... History function automatically searches for 5 latest parameters that are set with different values from the standard default setting.
- Searching and resetting of changed parameters.**
User parameter group, *U-r-U*, automatically searches for only those parameters that are set with different values from the standard default setting and display them. This function makes the parameter setting check and resetting easily.



Communication Network

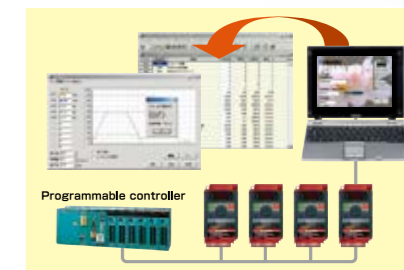

A RJ45 connector for RS485 communication is located on the bottom of the VF-nC3.

Built-in RS485 communication

- Built-in RS485 communication enable to control the inverter and build network.
- Communication rate : 38.4 kbps max.
 - Compatible with the Modbus RTU and Toshiba protocols.
- You can connect a PC to manage parameters and monitor operating conditions.

Simple Installation

The vertically oriented main circuit terminal block allows easy wiring.

Like power distribution devices, the main circuit terminal block of the VF-nC3 is vertically oriented to make wiring easy and minimize tangles of cable.

Side-by-side installation for space-saving

Generally, inverters must be placed in consideration of radiation of heat. The VF-nC3 can be placed side by side with no gap, saving inside of control panel space.*1

Side-by-side installation



The covers for the main circuit terminal block ensure safety.

You can remove the covers for the main circuit terminal block with a screwdriver. Since the covers can be attached after the wiring of the main circuit terminal block, the VF-nC3 can be installed easily and safely.

Main circuit terminal block cover



*1: Necessary to reduce output current on some conditions.

Simple Operation

The “turn-and-push” setting dial makes setup easily.

The large setting dial at the center of the front panel allows you to set the parameters easily. Just turn the setting dial until you get the right parameter and push the setting dial to select.

You can also use the setting dial to set the reference frequency.

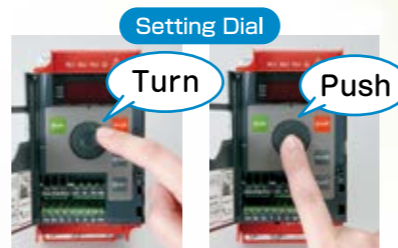

The RUN and STOP keys allow to operate easily.

You can operate the inverter with the **[RUN]** and **[STOP]** keys on the front panel. The front cover may be closed to conceal the other keys to avoid accidental key pressing.

RUN and STOP Keys



The Extension panel option allows to operate the VF-nC3 in front of the cabinet.

An extension panel option installed on the surface of the cabinet can operate the VF-nC3 in front of the cabinet.

It is possible to monitor the output frequency on the VF-nC3 and the output current on the extension panel option (RKPO07Z). It is possible to use it as a digital meter.

*The extension panel option is connected to the inverter with the optional cable. In the extension panel option, there is no setting dial.

Extension panel option <RKPO07Z>



●Models and Applicable Motors

Voltage (Input / Rated Output)	Applicable Motor Capacity (kW)						
	0.1	0.2	0.4	0.75	1.5	2.2	4.0
3ph-240V/3ph-240V	[Green bar]						
1ph-240V/3ph-240V	[Blue bar]						
1ph-120V/3ph-240V	[Purple bar]						

Index

Features	1
Application examples	4
Panel and operation procedure	5
Specification and dimensions	7
Connection diagram and terminal functions	9
List of parameters	11
Peripheral devices	13
For inverter users	16

Panel and operation procedure



Note: The above photo only shows the front body of the VF-nC3, and its front cover is removed for an explanatory purpose. Be sure to put the VF-nC3 in use with its front cover.

TOSVERT™ VF-nC3

Power on (setup parameter)

① When power on the inverter for the first time, **SEt** is blinking.



② Select an area code by the setting dial.

JP | USA | ASIA | EU



③ Press the center of the setting dial to confirm your change. When **inIt** is displayed and then **0.0**, you finish setting the setup parameter.



Monitor display

The LEDs on the operation panel display the following symbols indicate operations and parameters.

LED(number)

0	1	2	3	4	5	6	7	8	9	-
0	1	2	3	4	5	6	7	8	9	-

LED(alphabet)

Aa	Bb	C	c	Dd	Ee	Ff	Gg	H	h	I	i	Jj	Kk	Ll
R	b	l	c	d	E	F	G	H	h	i	,	U		L
Mm	Nn	O	o	Pp	Qq	Rr	Ss	Tt	Uu	Vv	Ww	Xx	Yy	Zz
n	n	0	a	p	q	r	s	t	u	v	w	x	y	z

Values set by each setup parameter

Title	Function	EU (Mainly in Europe)	USA (Mainly in North America)	ASIA (Mainly in Asia/Oceania)	JP (Mainly in Japan)
FH	Max.frequency	50.0(Hz)	60.0(Hz)	50.0(Hz)	80.0(Hz)
UL/L/F17	Frequency setting	50.0(Hz)	60.0(Hz)	50.0(Hz)	60.0(Hz)
F204	Frequency of V1 Input point2	50.0(Hz)	60.0(Hz)	50.0(Hz)	60.0(Hz)
UL/L/F17	Base frequency voltage 1&2	230(V)	230(V)	230(V)	200(V)
F127	Sink/source switching	100 [Source logic] (Positive common) (Common : P24)	0 [Sink logic] (Negative common) (Common : CC)		F.R.S1.S2 CC
F307	Power voltage compensation (Output voltage limit)	2	2	2	3
F417	Rated motor speed	1410(min ⁻¹)	1710(min ⁻¹)	1410(min ⁻¹)	1710(min ⁻¹)

Panel and operation procedure

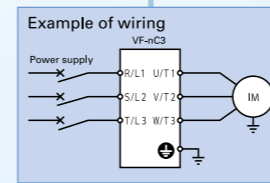

Operation

- Turn on the power. **0.0** is displayed.
- Pressing the RUN key and turning the setting dial ...
- Operates VF-nC3 at the frequency set by the setting dial.
- Turning the setting dial ...
- Changes the output frequency.
- Pressing the STOP key ...
- Decelerates and stops the motor.

Monitoring

- Displays operation frequency.
- Pressing the MODE key twice ...
- Displays the motor rotating direction.
- Turning the setting dial clockwise ...
- Displays operation frequency command value.
- Turning the setting dial clockwise ...
- Displays output current (%/ampere)
- Turning the setting dial clockwise, the various data are displayed such as input voltage, output voltage, the status of input/output terminal signals. Pressing the MODE key ...
- Displays operation frequency (returns to the beginning).

Setting

- Turn on the power. **0.0** is displayed.
- Pressing the mode key ...
- Displays "RUH".
- Turning the setting dial until "RCC" is displayed ...
- Displays "RCC".
- Press the center of the setting dial...
- Displays the setting value.
- Turn the setting dial and press the center of the setting dial...
- Displays "RCC", and the setting value alternately, and then the setting is completed.*

*If you press the center of the setting dial without changing the setting, the next parameter ("dEC") is displayed.

Item displayed	Panel operated	LED display	Description
Operation frequency *1		50.0	The operation frequency is displayed (Operation at 50Hz). (When standard monitor display selection F 7 10 is set at 0 (operation frequency))
Parameter setting mode	MODE	RUH	The first basic parameter "RUH" (history function) is displayed.
Direction of rotation	MODE	F _r -F	The direction of rotation is displayed. (F _r -F : forward run, F _r -r : reverse run)
Operation frequency command *1		F50.0	The operation frequency command value (Hz/free unit) is displayed. (In case of F 7 1 1=2)
Output current *1		l 80	The inverter output current (load current) (%/A) is displayed. (In case of F 7 1 2=1)
Input voltage *1		y 100	The inverter input voltage (DC detection) (%/V) is displayed. (In case of F 7 1 3=3)
Output voltage *1		P 100	The inverter output voltage (%/V) is displayed. (In case of F 7 1 4=4)
Inverter load factor *1		L 70	The inverter load factor (%) is displayed. (In case of F 7 1 5=2 7)
Operation frequency *1		o 50.0	The operation frequency (Hz/free unit) is displayed. (In case of F 7 1 6=0)
Input terminal		R ...	The ON/OFF status of each of the control signal input terminals (F, R, S1, S2, VI) is displayed in bits. ON : OFF :
Output terminal		0 ..	The ON/OFF status of each of the control signal output terminals (OUT and FL) is displayed in bits. ON : OFF :

Item displayed	Panel operated	LED display	Description
Logic input terminals setting		L-50	Logic setting by F127 is displayed. L-50 : Source logic L-5 : Sink logic
CPU1 version		u 101	The version of the CPU1 is displayed.
CPU2 version		u c 01	The version of the CPU2 is displayed.
Past trip 1		0 C 3 ⇐ 1	Past trip 1 (displayed alternately) *2
Past trip 2		0 H ⇐ 2	Past trip 2 (displayed alternately) *2
Past trip 3		0 P 3 ⇐ 3	Past trip 3 (displayed alternately) *2
Past trip 4		n E r r ⇐ 4	Past trip 4 (displayed alternately) *2
Parts replacement alarm information		n ...	The ON/OFF status of the parts replacement alarm of the cooling fan, circuit board capacitor and main circuit capacitor, and cumulative operation time are displayed in bits. ON : OFF : Cumulative operation time Cooling fan Control circuit board capacitor Main circuit capacitor
Cumulative operation time		t 0.10	The cumulative operation time is displayed. (0.01-1 hour, 1.00-100 hours)
Default display mode	MODE	50.0	The operation frequency is displayed (Operation at 50Hz).

*1 These monitor items can be selected by setting parameters F 7 0 1 to F 7 1 6. (F 7 2 0).
*2 Details on a past trip (of trips 1 to 4) can be displayed

Peripheral devices

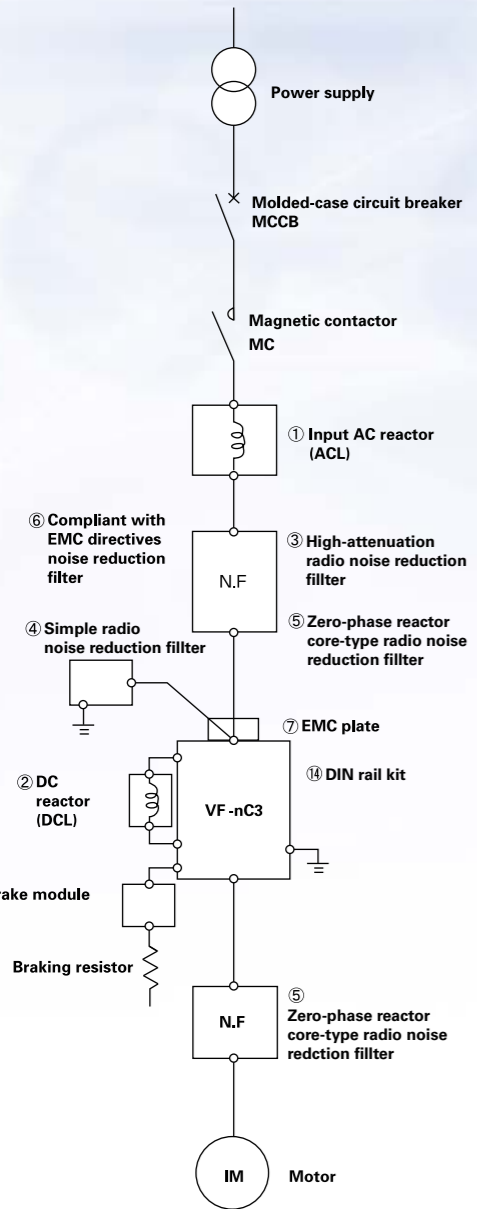

No.	Device	Function, Purpose, etc.	Refer to
①	Input AC reactor	Used to improve the input power factor, reduce the harmonics, and suppress external surge on the inverter power source side. Install when the power capacity is 200kVA or more and 10 times or more than the inverter capacity or when a distorted wave generation source such as a thyristor unit or a large-capacity inverter is connected in the same distribution system.	P.14
②	DC reactor	Improves the power factor more than the input reactor. When the facility applying the inverter requires high reliability, it is recommended to use the DC reactor with an input reactor effective for external surge suppression.	
③	High-attenuation filter (LC filter) NF type	These type of filters are not necessary for single-phase 240V (built-in EMC noise filter) model. The built-in filter meets IEC61800-3. ● Effective to prevent interference with audio equipment used near the inverter. ● Install on the input side of the inverter. ● Provided with wide-range attenuation characteristics from AM radio bands to near 10MHz. ● Use when equipment readily affected by noise is installed in the peripheral area.	P.14
④	Simple filter (capacitive filter) Capacitor type	● Effective to prevent interference with audio equipment used near the inverter. ● Install on the input side of the inverter. ● Attenuation characteristic is available only in a specific frequency and, effective in suppressing noise in a specific AM radio station (e.g., weak radio waves in mountainous regions). ● Increases leakage current because this is a capacitor-based filter. When the power supply is equipped with an ELCB, avoid using too many filters of this type.	
⑤	Zero-phase reactor (inductive filter) core type	● Effective to prevent interference with audio equipment used near the inverter. ● Effective in noise reduction on both input and output sides of the inverter. ● Provided with attenuation characteristics of several dB in frequencies from AM radio bands to 10MHz. ● For noise countermeasures, insert on the secondary side of the inverter.	-
⑥	Compliant with EMC directives noise reduction filter	This noise filter complies with European EMC Directive. *These type of filters are not necessary for single-phase 240V (built-in EMC noise filter) model. The built-in filter meets IEC61800-3 C1.	
⑦	EMC plate	A steel plate used to connect shielded grounding cables from inverter's power cables or to connect grounding cables from external devices.	P.7
⑧	Brake module	Use when rapid deceleration or stop is frequently required or when it is desired to reduce the deceleration time with large load. This module and resistor consumes regenerative energy during power generation braking. For 0.1 to 2.2kW models. <Type: BRMD0015Z>	-
⑨	Extension panel (parameter writer)	LED remote keypad is for extension. It is provided with an LED display, some operational keys. The panel with parameter writer function can setup and read the parameters for inverter.	P.15
⑩	USB communication unit	This unit is connected to a PLC or a computer to enable data communications. By connecting the connector cable, parameters can be easily adjusted, and data easily saved and written.	P.15
⑪	Remote panel	Has a built-in frequency meter, frequency setter and RUN-STOP (forward run, reverse run) switch.	P.15
⑫	Frequency meter	Use to mount the meter on an external operation unit.	P.15
⑬	FRH kit	FRH-kit includes frequency setting resistor, panel and knob for an external operation unit.	P.15
⑭	DIN rail kit	Use to mount the inverter on DIN rails. For 0.1 to 2.2kW models. <Type: DIN003Z, DIN005Z>	-

Peripheral devices

Voltage class	Inverter model	Applicable motor (kW)	Input AC reactor (ACL)	DC reactor (DCL)	Radio noise reduction filter		
					High-attenuation filter	Simple filter	Zero-phase reactor
3-phase 240V	VFNC3-2001P	0.1	PFL-2001S	DCL3-4004	RCL-M2	NF3005A-MJ	RC5078ZZ
	VFNC3-2002P	0.2	PFL-2001S	DCL3-4007			
	VFNC3-2004P	0.4	PFL-2005S	DCL3-4015			
	VFNC3-2007P	0.75	PFL-2005S	DCL3-2007			
	VFNC3-2015P	1.5	PFL-2011S	DCL3-2015			
	VFNC3-2022P	2.2	PFL-2011S	DCL3-2022			
	VFNC3-2037P	4.0	PFL-2018S	DCL3-2037			
1-phase 240V	VFNC3S-2001PL	0.1	PFL-2005S	DCL3-4007	The EMC noise filter is built into the 1ph-240V models by the standard.	-	RC5078ZZ
	VFNC3S-2002PL	0.2	PFL-2005S	DCL3-4015			
	VFNC3S-2004PL	0.4	PFL-2005S	DCL3-2007			
	VFNC3S-2007PL	0.75	PFL-2011S	DCL3-2015			
	VFNC3S-2015PL	1.5	PFL-2018S	DCL3-2037			
VFNC3S-2022PL	2.2	PFL-2018S	DCL3-2037				
1-phase 120V	VFNC3S-1001P	0.1	PFL-2005S	1ph-120V models cannot be used with DC reactors.	RCL-M2	NF3005A-MJ	RC5078ZZ
	VFNC3S-1002P	0.2	PFL-2005S				
	VFNC3S-1004P	0.4	PFL-2018S				
	VFNC3S-1007P	0.75	PFL-2018S				
	VFNC3S-1007P	0.75	PFL-2018S				

External dimensions and connections

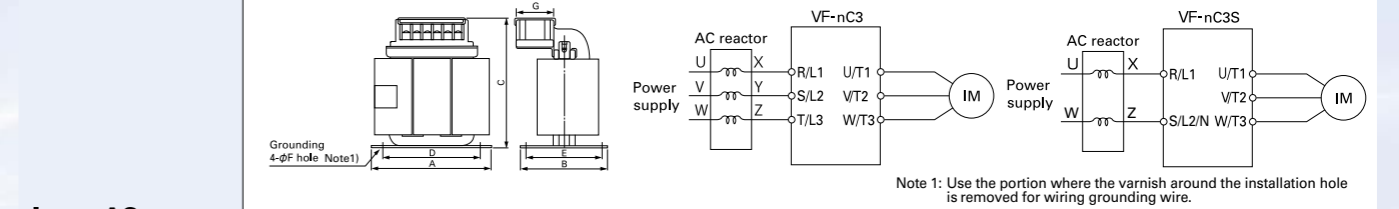

Input AC reactor (ACL)

Model	Rating	Inverter type		Dimensions(mm)							Terminal (Terminal block)	Approx. mass (kg)
		VFNC3-	VFNC3S-	A	B	C	D	E	F	G		
PFL-2001S	3-phase 200V class -1.7A-50/60Hz	2001P,2002P	-	105	65	115	90	55	5	40	M 3.5	1.0
PFL-2005S	3-phase 200V class -5.5A-50/60Hz	2004P,2007P	2001PL,2002PL,2004PL,1001P,1002P	105	65	115	90	55	5	40	M 3.5	1.2
PFL-2011S	3-phase 200V class -11A-50/60Hz	2015P,2022P	2007PL	130	70	140	115	60	5	50	M4	2.3
PFL-2018S	3-phase 200V class -18A-50/60Hz	2037P	2015PL,2022PL,1004P,1007P	130	70	140	115	60	5	50	M4	2.5

DC reactor (DCL)

1ph-120V models cannot be used with DC reactors. Please select input AC reactors.

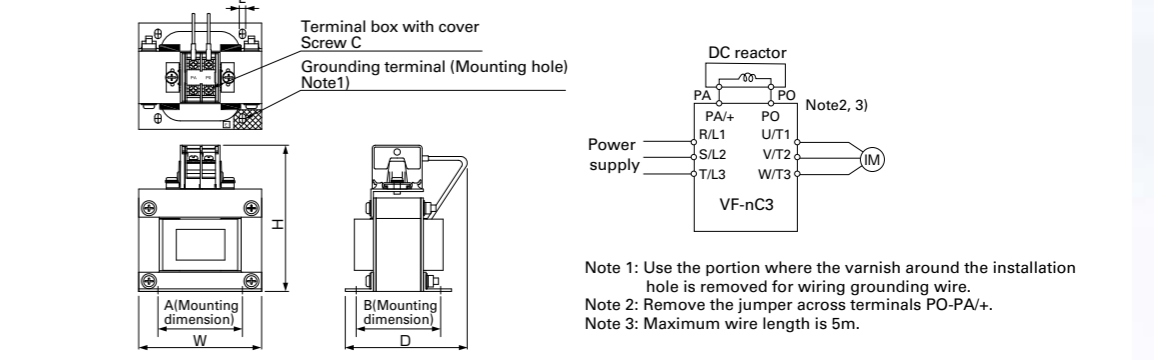

Model	Inverter type		Dimensions(mm)							Approx. mass (kg)
	VFNC3-	VFNC3S-	W	H	D	A	B	C	E	
DCL3-2007	2007P	2004PL	75	116	78	54	51	M4	5	1.0
DCL3-2015	2015P	2007PL								1.0
DCL3-2022	2022P	-	96	118	100	66	66	M4	5	1.1
DCL3-2037	2037P	2015PL, 2022PL								2.2
DCL3-4004	2001P	-	75	116	78	54	51	M4	5	1.0
DCL3-4007	2002P	2001PL								1.0
DCL3-4015	2004P	2002PL	-	-	-	-	-	-	-	1.0

High-attenuation radio noise reduction filter (NF type)

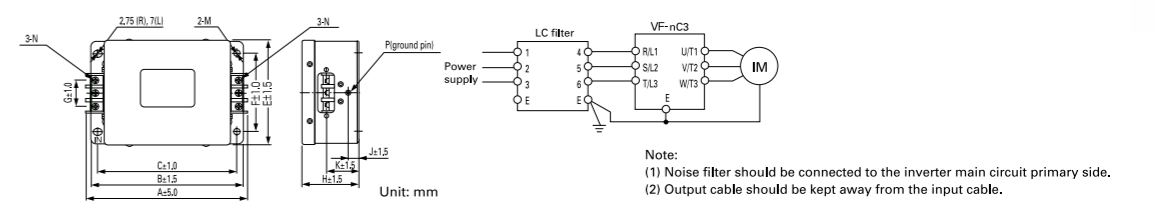

Model	Rated current (A)	Inverter type		Dimensions(mm)											Approx. mass (kg)	
		VFNC3-	VFNC3S-	A	B	C	E	F	G	H	J	K	M	N		P
NF3005A-MJ	5	2001P, 2002P, 2004P, 2007P	1001P	174.5	160	145	110	80	32	70	20	45	φ5.5	M4	M4	1.0
NF3015A-MJ	15	2015P, 2022P	1002P, 1004P													1.6
NF3020A-MJ	20	2037P	1007P													1.6

Simple radio noise reduction filter (capacitive filter)

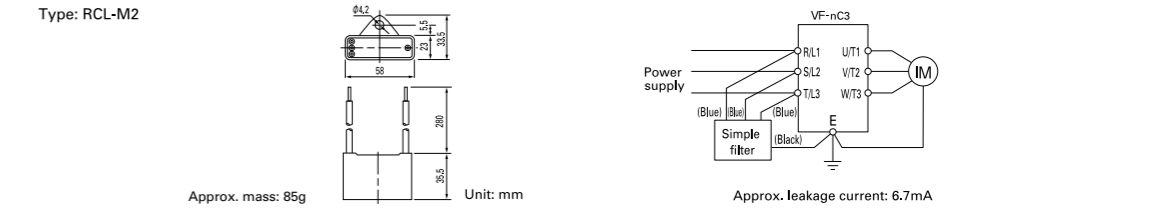

Zero-phase reactor core-type radio noise reduction filter

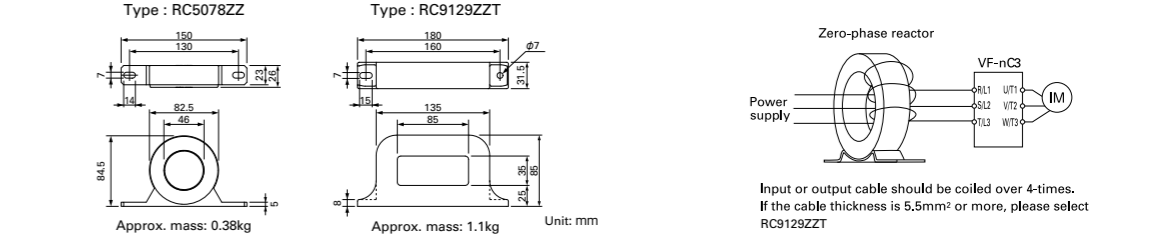

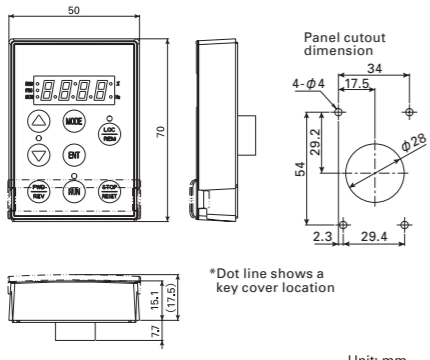
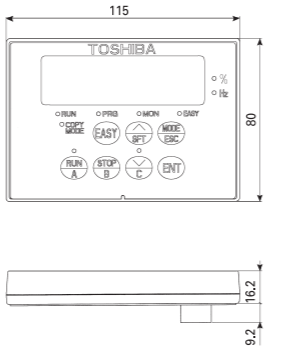
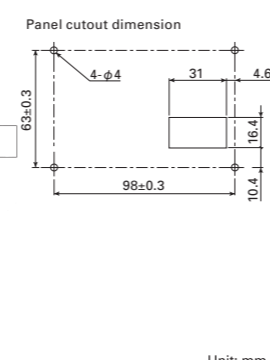
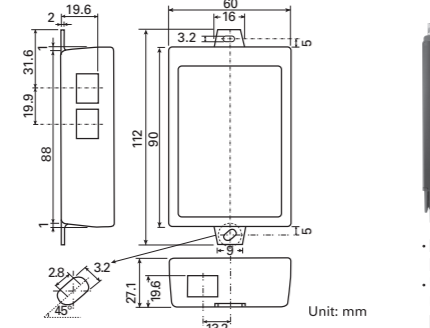
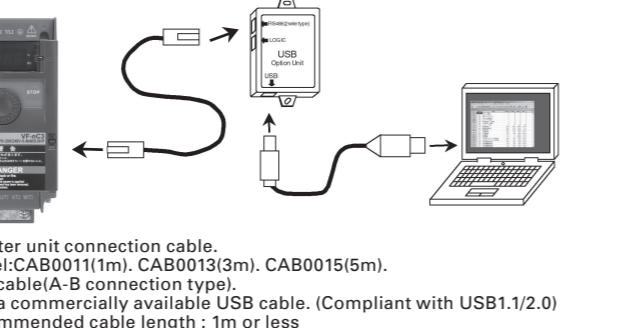
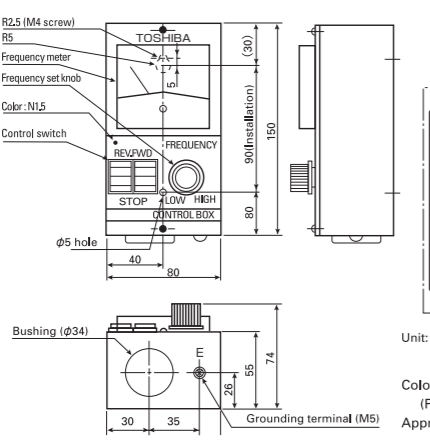
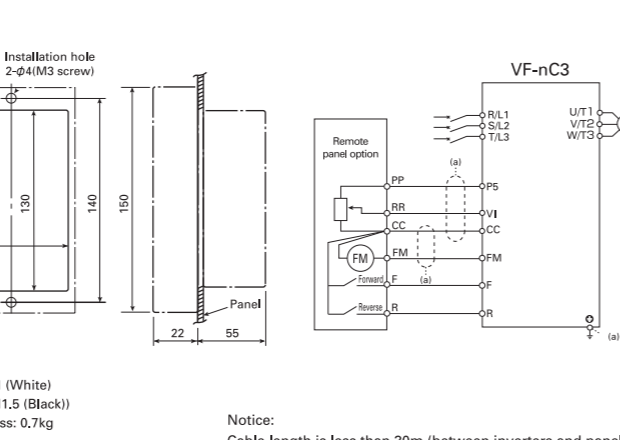
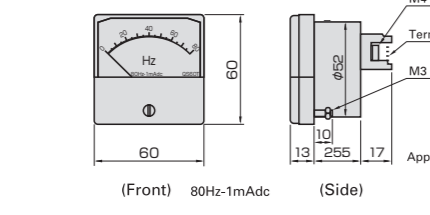
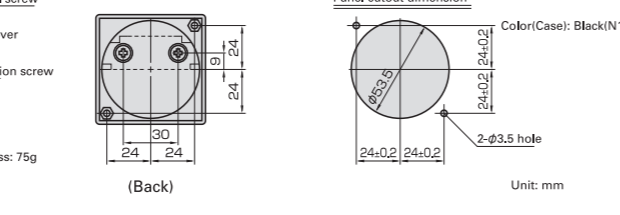
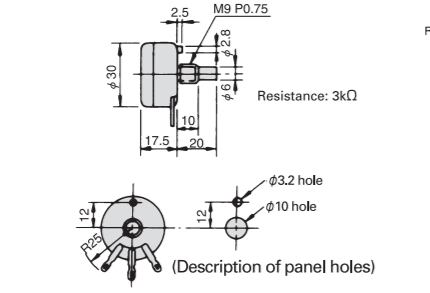
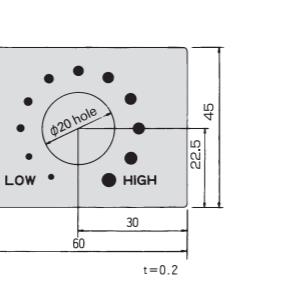
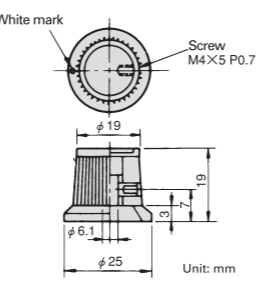
Devices	External dimensions and connections		
Extension panel	Type: RKP007Z  Unit: mm · Communication cable (option). Model : CAB0071(1m), CAB0073(3m), CAB0075(5m)	Type: RKP002Z  Unit: mm · Communication cable (option). Model : CAB0011(1m), CAB0013(3m), CAB0015(5m)	* With parameter writer function  Unit: mm
USB communications conversion unit	Type: USB001Z  Unit: mm	VF-nC3  · Inverter unit connection cable. Model: CAB0011(1m), CAB0013(3m), CAB0015(5m). · USB cable(A-B connection type). · USB a commercially available USB cable. (Compliant with USB1.1/2.0) · Recommended cable length : 1m or less	
Remote panel	Type: CBVR-7B1  Unit: mm Color: 5Y7/1 (White) (Panel: N1.5 (Black)) Approx. mass: 0.7kg Notice: Cable length is less than 30m (between inverters and panels).	Connection 	
Frequency meter	Type: QS60T  (Front) 80Hz-1mAcd (Side) (Back) Approx. mass: 75g	Panel cutout dimension  Unit: mm Color(Case): Black(N1.5)	
FRH kit	Frequency setting resistor<RV30YN-20S-B302>  Resistance: 3kΩ (Description of panel holes)	Frequency setting panel  Unit: mm t=0.2	Frequency setting knob <K-3>  Unit: mm

For inverter users

1. When studying how to use our inverters

Notes

Leakage current

This inverter uses high-speed switching semiconductors for PWM control. When a relatively long cable is used for power supply to an inverter, current may leak from the cable or the motor to the ground because of its capacitance, adversely affecting peripheral equipment. The intensity of such a leakage current depends on the PWM carrier frequency setting, the lengths of the input and output cables, etc., of the inverter. To prevent current leakage, it is recommended to take the following measures.

[Effects of leakage current]

Leakage current which increases when an inverter is used may pass through the following routes:

- Route (1) ... Leakage due to the capacitance between the ground and the noise filter
- Route (2) ... Leakage due to the capacitance between the ground and the inverter
- Route (3) ... Leakage due to the capacitance between ground and the cable connecting the inverter and the motor
- Route (4) ... Leakage due to the capacitance of the cable connecting the inverter and the motor in another power distribution line
- Route (5) ... Leakage through the grounding line common to motors
- Route (6) ... Leakage to another line because of the capacitance of the ground

Leakage current which passes through the above routes may cause the following trouble.

- Malfunction of a leakage circuit breaker(ELCB) in the same or another power distribution line
- Malfunction of a ground-relay installed in the same or another power distribution line
- Noise produced at the output of an electronic device in another power distribution line
- Activation of an external thermal relay installed between the inverter and the motor, at a current below the rated current

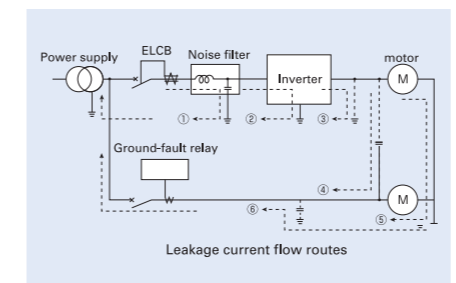

[Measures against effects of leakage current]

The measures against the effects of earth leakage current are as follows:

- 1) Measures to prevent the malfunction of leakage circuit breakers (ELCB)
 - (1) Decrease the PWM carrier frequency of the inverter. Note)

- (2) Use radio-frequency interference-proof ELCBs as ground-fault interrupters in not only the system into which the inverter is incorporated but also other systems. When the ELCBs are used, the PWM carrier frequency enable to be increased to operate the inverter.
- (3) When connecting multiple inverters to a single ELCB, use an ELCB with a high current sensitivity or reduce the number of inverters connected to the ELCB.

2) Measures against malfunction of ground-fault relay:

- (1) Decrease the PWM carrier frequency of the inverter. Note)
- (2) Install ground-fault relays with a high-frequency protective function in both the same and other lines. When the relays are used, the PWM carrier frequency enable to be increased to operate the inverter.

3) Measures against noise produced by other electric and electronic systems:

- (1) Separate the grounding line of the inverter from that of the affected electric and electronic systems.
- (2) Decrease the PWM carrier frequency of the inverter. Note)

4) Measures against malfunction of external thermal relays:

- (1) Remove the external thermal relay and use the electronic thermal function of the inverter instead of it. (Unapplicable to cases where a single inverter is used to drive more than one motor. Refer to the instruction manual for measures to be taken when thermal relays cannot be removed.)
- (2) Decrease the PWM carrier frequency of the inverter. Note)

5) Measures by means of wiring and grounding

- (1) Use a grounding wire as large as possible.
- (2) Separate the inverter's grounding wire from that of other systems or install the grounding wire of each system separately to the grounding point.
- (3) Ground (shield) the main circuit wires with metallic conduits.
- (4) Use the shortest possible cables to connect the inverter to the motor.
- (5) If the inverter has a high-attenuation EMC filter, turn off the grounding capacitor detachment switch to reduce the leakage current. Note that doing so leads to a reduction in the noise attenuating effect.

Note) In the case of this inverter, the PWM carrier frequency can be decreased to 2.0kHz. Decreasing the carrier frequency results in an increase in electromagnetic noise from the motor.

Ground fault

Before beginning operation, thoroughly check the wiring between the motor and the inverter for incorrect wiring or short circuits. Do not ground the neutral point of any star-connected motor.

Radio interference

[Noise produced by inverters]

Since this inverter performs PWM control, it produces noise and sometimes affects nearby instrumental devices, electrical and electronic systems, etc. The effects of noise greatly vary with the noise resistance of each individual device, its wiring condition, the distance

between it and the inverter, etc.

[Measures against noises]

According to the route through which noise is transmitted, the noises produced by an inverter are classified into transmission noise, induction noise and radiation noise.

[Examples of protective measures]

- Separate the power line from other lines, such as weak-current lines and signal lines, and install them apart from each other.
- Install a noise filter in each inverter. It is effective for noise prevention to install noise filters in other devices and systems, as well.
- Shield cables and wires with grounded metallic conduits, and cover electronic systems with grounded metallic cases.
- Separate the power distribution line of the inverter from that of other devices and systems.
- Install the input and output cables of the inverter apart from each other.
- Use shielded twisted pair wires for wiring of the weak-current and signal circuits, and always ground one of each pair of wires.
- Ground the inverter with grounding wires as large and short as possible, separately from other devices and systems.

1ph-240V models have built-in EMC noise filters on their input side, and reduce noise greatly.

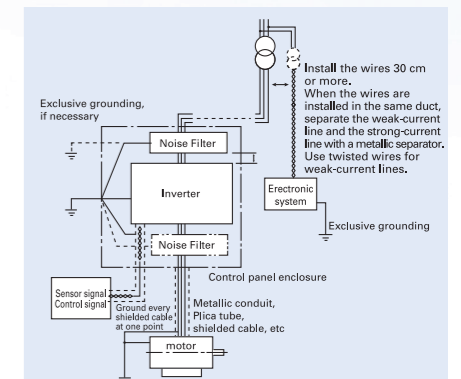

Power factor improvement capacitors

Do not install a power factor improvement capacitors on the output side of the inverter.

Installing a power factor improvement capacitor on the output side causes current containing harmonic components to flow into the capacitor, adversely affecting the capacitor itself or causing the inverter to trip. To improve the power factor, install an input AC reactor on the primary side of the inverter or install a DC reactor.

Installation of input AC reactors

These devices are used to improve the input power factor and suppress high harmonic currents and surges. Install an input AC reactor when using this inverter under the following conditions:

- (1) When the power source capacity is 200kVA or more, and when it is 10 times or more greater than the inverter capacity.
- (2) When the inverter is connected the same power distribution system as a thyristor-committed control equipment.
- (3) When the inverter is connected to the same power distribution system as that of distorted wave-producing systems, such as arc furnaces and large-capacity inverters.

2. Selecting the Capacity (model) of the Inverter

○ Selection

Capacity

Refer to the applicable motor capacities listed in the standard specifications.

When driving some motors in parallel, select such an inverter that the sum of the motor rated current multiplied by 1.05 to 1.1 is less than the inverter's rated output current value.

Acceleration/deceleration times

The actual acceleration and deceleration times of a motor driven by an inverter are determined by the torque and moment of inertia of the load, and can be calculated by the following equations.

The acceleration and deceleration times of an inverter can be set individually. In any case, however, they should be set longer than their respective values determined by the following equations.

Acceleration time	$t_a = \frac{(JM+JL) \times \Delta N}{9.56 \times (TM-TL)}$ (sec.)
Deceleration time	$t_d = \frac{(JM+JL) \times \Delta N}{9.56 \times (TB+TL)}$ (sec.)
Conditions	<p>JM : Moment of inertia of motor (kg,m²) JL : Moment of inertia of load (kg,m²) (converted into value on motor shaft) ΔN : Difference in rotating speed between before and after acc. or dec. (min.⁻¹) TL : Load torque (N,m) TM : Motor rated torque x 1.2 to 1.3 (N,m) ... V/f control ... Motor rated torque x 1.5 (N,m) ... Vector operation control TB : Motor rated torque x 0.2 (N,m) (When a braking resistor or a braking resistor unit is used.) (Motor rated torque x 0.8 to 1.0 (N,m))</p>

Allowable torque characteristics

When a standard motor is combined with an inverter to perform variable speed operation, the motor temperature rises slightly higher than it normally does during commercial power supply operation. This is because the inverter output voltage has a sinusoidal (approximate) PWM waveform. In addition, the cooling becomes less effective at low speed, so the torque must be

reduced according to the frequency. Regarding the allowable torque characteristic, please confirm its motor manufacturer.

When constant-torque operation must be performed at low speeds, use a Toshiba VF motor designed specifically for use with inverters.

Starting characteristics

When a motor is driven by an inverter, its operation is restricted by the inverter's overload current rating, so the starting characteristic is different from those obtained from commercial power supply operation.

Although the starting torque is smaller with an inverter than with the commercial power supply, a high starting torque can be produced at low speeds by adjusting the V/f pattern torque boost amount or by employing vector control. When a larger starting torque is necessary, select an inverter with a larger capacity and examine the possibility of increasing the motor capacity.

3. When installing, wiring and operating the inverter

○ Selection

Installing precautions

- Do not install in any location of high temperature, high humidity, moisture condensation and freezing. Do not install the inverter where there are gases that corrode metal or solvents that adversely affect plastic. Avoid locations where there is exposure to water and/or where there may be large amounts of dust and metallic fragments. In this case, please install inverters in the enclosure type cabinet. The cabinet must be considered its size and the cooling method to allow the specifications of an ambient temperature for inverters.
- Must be installed in non-inflammables such as metals. The rear panel gets very hot. If installation is in an inflammable object, this can result in fire.
- Inverters should be arranged in horizontal rows.

Wiring precautions

Installing a molded-case circuit breaker [MCCB]

- Install a molded-case circuit breaker (MCCB) on the inverter's power supply input to protect the wiring.
- Avoid turning the molded-case circuit breaker on and off frequently to turn on/off the motor. To turn on/off the motor frequently, close/break the control terminals F (or R)-CC.

Installing a magnetic contactor [MC] [primary side]

- To prevent an automatic restart after the power interruption or overload relay has tripped, or actuation of the protective circuit, install an electro-magnetic contact in the power supply.
- The inverter is provided with a fault detection relay (FL), so that, if its contacts are connected to the operation circuit of the magnetic contactor on the primary side, the magnetic contactor will be opened when the protective circuit of the inverter is activated.
- The inverter can be used without a magnetic contactor. In this case, use an MCCB (equipped with a voltage tripping device) for opening the primary circuit when the inverter protective circuit is activated.

- Avoid turning the magnetic contactor on and off frequently to turn on/off the motor.
- To turn on/off the motor frequently, close/break the control terminals F (or R)-CC.
- Install surge suppressor on any magnetic contactor and relay coils used around the inverter.
- If using a braking resistor, install a magnetic contactor (MC) to the power supply of the inverter, so that the power circuit opens when the internal overload relay of the braking resistor is activated.

Installing a magnetic contactor [MC] [secondary side]

- As a rule, if a magnetic contactor is installed between the inverter and the motor, do not turn on/OFF while running. (If the secondary-side contactor is turned of ON/OFF while running, a large current may flow in the inverter, causing inverter damage and failure.)
- A magnetic contactor may be installed to change the motor or change to the commercial power supply when the inverter is stopped. Always use an interlock with the magnetic contactor in this situation so that the commercial power supply is not applied to the inverter's output terminals.

External signal

- Use a relay rated for low currents. Mount a surge suppressor on the excitation coil of the relay.
- When wiring the control circuit, use shielded wires or twisted pair cables.
- Because all of the control terminals except FLA, FLB and FLC are connected to electronic circuits, insulate these terminals to prevent them from coming into contact with the main circuit.

Installing an overload relay

- This inverter has an electronic-thermal overload protective function. However, in the following cases, the thermal relay operation level must be adjusted or an overload relay matching the motor's characteristics must be installed between the inverter and the motor.
 - When using a motor having a rated current value different from that of the equivalent.
 - When driving several motors simultaneously.

- When using the inverter to control the operation of a constant-torque motor (VF motor), change the protective characteristic of the electronic thermal relay according to the setting of the VF motor.
- In order to adequately protect a motor used for low-speed operation, we recommend the use of a motor equipped with an embedded thermal relay.

Wiring

- Do not connect input power to the output (motor side) terminals (U/T1,V/T2,W/T3). That will destroy the inverter and may result in fire. Please pay attentions of wiring before power supply turns-on.
- The DC terminals (PA+, PO and PC-) are for specified options. Do not connect other devices to these terminal.
- Within 15 minutes after turning off input power, do not touch wires of devices connected to the input side of the inverter.

Grounding

The inverters and motors must be connected to ground securely. In case of grounding for inverters, please use the grounding terminal of the inverter.

○ Operating precautions

- The inverter operates in abnormal circumstances the security function, and stops outputting. However, the inverters can not stop the motors quickly. Please install the mechanical brake or maintenance function in the mechanical equipment and the device for which the emergency stop is necessary.
- When you drive the machine and the device that hangs the load repeatedly with the inverter, the semiconductor within inverter might cause thermal fatigue, and it come to have a short life if a big current flows repeatedly when driving and stopping. In this case, it is possible to extend life span by controlling the starting current and the load current low or setting the PWM carrier frequency low. If you can not decrease the starting current, please select larger capacity of inverters for current margins.

4. When changing the motor speed

○ Application to standard motors

Vibration

When a motor is operated with an industrial inverter, it experiences more vibrations than when it is operated by the commercial power supply. The vibration can be reduced to a negligible level by securing the motor and machine to the base firmly. If the base is weak, however, the vibration may increase at a light load due to resonance with the mechanical system.

Setting the jump frequency or changing the PWM carrier frequency enable to reduce vibration.

Acoustic noise

The magnetic noise of motors with inverter drives is changed by PWM carrier frequency. In case of high PWM carrier frequency settings, its acoustic noise is almost same as commercial power supply drives. Moreover, when the motors are operated over rated rotation, the windy noise of the motors is increased.

Reduction gear, belt, chain

Note that the lubrication capability of a reducer or a converter used as the interface of the motor and the load machine may affected at low speeds.

When operating at a frequencies exceeding 60 Hz or higher, power transmission mechanisms such as reduction gear, belts and chains, may cause problems such as production of noise, a reduction in strength, or shortening of service life.

Frequency

Before setting the maximum frequency to 60 Hz or higher, confirm that this operating range is acceptable for the motor.

Starting method

When you drive the motor with changeable connection between star-connection and delta-connection for decreasing starting current, please connect delta-connection only. If you

change motor connection while inverter drives, the protective function of inverter occurs.

○ Application to special motors

Gear motor

When using an inverter to drive a gear motor, inquire of the motor manufacturer about its continuous operation range due to the followings:

- The low-speed operation of a gear motor may cause insufficient lubrication
- The loss of a gear may be increasing than commercial power supply drives.
- In case of the high frequency operation, the acoustic noise and motor temperature may be higher.

Toshiba Gold Motor

(High-efficiency power-saving motor)

Inverter-driven operation of Toshiba Gold Motors is the best solution for saving energy. This is because these motors have improved efficiency, power factor, and noise/vibration reduction characteristics when compared to standard motors.

Pole-changing motor

Pole-changing motors can be driven by this inverter. Before changing poles, however, be sure to let the motor come to a complete stop. If you change motor connection while inverter drives, the protective function of inverter occurs.

Underwater motors

Note that underwater motors have higher rated current than general motors.

The current ratings of underwater motors are relatively high. So, when selecting an inverter, you must pay special attention to its current rating so that the current rating of the motor is below that of the inverter.

When the lengths of the motor cable are long, please use thicker cable than a table of "Wiring

devices" because the maximum torque is decreased by the voltage dropping. Moreover, please pay attention to select leakage circuit breakers.

Single-phase motor

Because single-phase motors are equipped with a centrifugal switch and capacitors for starting, they cannot be driven by an inverter. When single phase motors are driven by inverters, a centrifugal switch and capacitors may be broken. If only a single-phase, power system is available a 3-phase motor can be driven by using a single-phase input inverter to convert it into a 3-phase 240V output. (A special inverter and a 3-phase 240V motor are required.)

Braking motor

When using a braking motor, if the braking circuit is directly connected to the inverter's output terminals, the brake cannot be released because of the lowered starting voltage. Therefore, when using a braking motor, connect the braking circuit to the inverter's power supply side, as shown on the below. Usually, braking motors produce larger noise in low speed ranges.

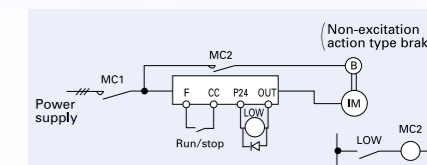

For users of the products : Our variable speed drives are designed to control the speeds of three-phase motors for general industry.

Precautions

- * Please read the instruction manual before installing or operating the drive unit.
- * This product is intended for general purpose uses in industrial application. It cannot be used applications where may cause big impact on public uses, such as power plant and railway, and equipment which endanger human life or injury, such as nuclear power control, aviation, space flight control, traffic, safety device, amusement, or medical.
It may be considerable whether to apply, under the special condition or an application where strict quality control may not be required. Please contact our headquarters, branch, or local offices printed on the front and back covers of this catalogue.
- * When exporting Toshiba variable speed drive separately or combined with your equipment, please be sure to satisfy the objective conditions and inform conditions listed in the export control policies, so called Catch All restrictions, which are set by the Ministry of Economy, Trade and Industry of Japan, and the appropriate export procedures must also be taken.
- * Please use our product in applications where do not cause serious accidents or damages even if product is failure, or please use in environment where safety equipment is applicable or a backup circuit device is provided outside the system.
- * Please do not use our product for any load other than three-phase motors.
- * None of Toshiba, its subsidiaries, affiliates or agents, shall be liable for any physical damages, including, without limitation, malfunction, anomaly, breakdown or any other problem that may occur to any apparatus in which the Toshiba variable speed drive is incorporated or to any equipment that is used in combination with the Toshiba variable speed drive. Nor shall Toshiba, its subsidiaries, affiliates or agents be liable for any compensatory damages resulting from such utilization, including compensation for special, indirect, incidental, consequential, punitive or exemplary damages, or for loss of profit, income or data, even if the user has been advised or apprised of the likelihood of the occurrence of such loss or damages.

For further information, please contact your nearest Toshiba Representative or International Operations-Producer Goods.
The information in this brochure is subject to change without notice.

Toshiba Industrial Products and Systems Corporation

Global Sales Group Motor Drive Division

10th Floor, LAZONA Kawasaki TOSHIBA building, 72-34, Horikawa-cho, Saiwai-ku, Kawasaki-shi, Kanagawa 212-8585, Japan

Tel: +81-44-520-0828 Fax: +81-44-520-0508

<http://www.toshiba-tips.co.jp/en/>

CKVJ-1134

2021-11 