

Endura ACA592

2-electrode conductivity transmitter



Measurement made easy

Rugged design transmitter for industrial applications

Introduction

The Endura ACA592 2-electrode conductivity transmitter is intended for low conductivity measurement.

The ACA592 2-electrode conductivity transmitter is fully compatible with ABB's comprehensive range of 2-electrode conductivity sensors and enables users to measure conductivity in applications from clean water to harsh chemicals.

The ACA592 has automatic temperature sensor recognition for both 2- and 3-wire RTD inputs from common inputs such as Pt100, Pt1000 and 3k Balco.

ACA592 transmitters are communication-ready field devices with microprocessor-controlled electronics. For bi-directional communication, an FSK signal is superimposed on the 4 to 20 mA output signal via the HART protocol.

The device type manager (DTM) can be used to configure, poll and test devices on a PC. Handheld terminals such as the DHH801 also support communication.

The transmitter is equipped with an LCD display used to show the current process data. The four keys beneath the transmitter enable local configuration.

For more information

Further publications for the Endura ACA592 2-electrode conductivity transmitter are available for free download from:

www.abb.com/analytical

See links and reference numbers below or scan this code:



Description	Search for or click on
Data Sheet Endura ACA592 Conductivity transmitter	DS/ACA592-EN
Addendum RoHS Directive 2011/65/EU (RoHS II)	ADD/MEASUREMENT/001-EN

Contents

1	Safety	4
1.1	Technical Limits	4
1.2	Operator Liability	4
1.2.1	Operating Safety Information	4
1.2.2	Special Conditions of Use (FM Approval)	4
1.3	Health & Safety	5
1.4	Electrical Safety – IEC / EN 61010-1	5
1.4.1	Electrical Installation Safety Information	5
1.5	Symbols – EN / IEC 61010-1	6
1.6	Product Recycling Information	7
1.7	Product Disposal	8
1.7.1	Information on WEEE Directive 2002/96/EC (Waste Electrical and Electronic Equipment)	8
1.8	Returning Transmitters	9
1.8.1	Transport Safety Information	9
1.9	Restriction of Hazardous Substances (RoHS)	9
1.10	Safety Precautions	9
1.11	Safety Conventions	10
1.12	Safety Recommendations	10
1.13	Service and Repairs	10
1.14	Potential Safety Hazards	10
2	Use in Areas Requiring Ignition Protection	11
2.1	Approvals	11
2.1.1	CE Mark	11
2.1.2	Ignition Protection	11
2.2	Ground	11
2.3	Interconnection	11
2.4	Configuration	11
2.5	Hazardous Area Relevant Information	12
2.5.1	ACA592-XX.A1... (Intrinsic Safety)	12
2.5.2	ACA592-XX.A2... (Flameproof Protection)	13
2.5.3	ACA592-XX.A3... (Type n Non-sparking)	13
2.5.4	ACA592-XX.F1 or .C1 (Intrinsic Safety)	14
2.5.5	ACA592-XX.F2 or .C2 (Explosion-proof)	15
2.5.6	ACA592-XX.F3 or .C3 (Non-incendive)	15
3	Mechanical Installation	17
3.1	Hazardous Area Installation	17
3.2	Non-hazardous area installation	17
3.3	Installation Conditions	18
3.4	Dimensions	19
3.4.1	Transmitter-only Dimensions (Excluding Mounting Bracket)	19
3.4.2	Wall-mount Transmitter Dimensions	20
3.4.3	Pipe-mount Transmitter Dimensions	21
3.4.4	Transmitter Label	22
3.4.5	'HazLoc' Labels	23
3.4.6	Aligning the Cartridge LCD Display	25

4	Electrical Installation	26
4.1	Cable Glands and Plugs	26
4.1.1	ACA592–XX for Intrinsically Safe, Type n, and Non-incendive Installations	26
4.1.2	ACA592–XX Ex d Models without Cable Gland	26
4.2	DC Power Supply Connections	28
4.3	Sensor Connections	29
4.3.1	ACA592 2-Electrode Conductivity Transmitter – Sensor Connections	30
4.4	Integral Sensor Cable Connection	31
4.5	Junction Box and Extension Cable Connection	31
4.6	Power Supply Requirements	32
4.6.1	Standard Application	32
4.6.2	Standard Application with HART Functionality	33
4.6.3	Electrical Connection in Hazardous Area	34
4.6.4	Installation in Hazardous Areas	35
5	Start-up and Operation	39
5.1	Navigating Menus and Parameters	39
5.2	Security Levels and Password Access	40
5.2.1	Security Permissions	41
5.2.2	Default Passwords	41
5.3	Configuration Menu Overview	42
6	Configuration	44
6.1	Configuration Options	44
6.2	Configuration DIP Switch	45
7	Operator Pages and Menus	46
7.1	Process Display	46
7.1.1	Operator Pages	47
7.2	Parameter Maps	50
7.2.1	ACA592 2-Electrode Conductivity Transmitter – Conductivity Parameter Map	50
7.2.2	ACA592 2-Electrode Conductivity Transmitter – Concentration Parameter Map	51
7.3	ACA592 2-Electrode Conductivity Transmitter Parameters	52
7.3.1	Easy Setup	52
7.3.2	Calibrate	53
7.3.3	Device Setup	55
7.3.4	Input/Output	58
7.3.5	Display	59
7.3.6	Diagnostics	60
7.3.7	Communication	61
7.3.8	Service	62
8	Troubleshooting and Diagnostics	63
8.1	Diagnostic Messages	64
8.2	Diagnosis Screens	68
8.2.1	ACA592 2-Electrode Conductivity Transmitter – Diagnosis Overview Screen	68
8.2.2	ACA592 2-Electrode Conductivity Transmitter – Diagnosis Masking	69
8.2.3	ACA592 2-Electrode Conductivity Transmitter – Diagnosis Simulation	69

9 HART Communication	71
9.1 HART Device Type Codes	71
9.2 HART Configuration Maps	72
9.3 HART Universal Commands	74
9.4 HART Common Practice Commands	76
10 Specification	78
11 Spares and Accessories	82
Appendix A Permits and Certification	84
Appendix B Installation Drawings	85
B.1 Drawing P0908	85
B.2 Drawing P0909	86
B.3 Drawing P0910	87
B.4 Drawing P0911	88

1 Safety

Warning.

- System configuration must be carried out only by users or personnel with approved access rights (user privileges).
- Read all relevant sections of this guide before configuring the system or modifying system parameters.
- Install and use this equipment as detailed in this guide. Install and use associated equipment in accordance with the relevant national and local standards. Installation and repair must only be carried out by the manufacturer, authorized agents or persons conversant with the construction standards for hazardous area certified equipment.

Information in this manual is intended only to assist our customers in the efficient operation of our equipment. Use of this manual for any other purpose is specifically prohibited and its contents are not to be reproduced in full or part without prior approval of the Technical Publications Department.

1.1 Technical Limits

The transmitter is designed for use exclusively within the stated values on the name plate and in the technical specifications (see Specifications, page 78). These must be complied with accordingly:

- Do not exceed the maximum / permitted operating temperature.
- Observe the housing protection system.

1.2 Operator Liability

When measuring corrosive and abrasive materials, the operator must examine the resistance of all parts that come into contact with the process being measured. ABB will assist with the selection but cannot, however, accept any liability.

Operators must strictly observe the national regulations applicable in their countries with regards to installation, functional tests, repairs and maintenance of electrical devices.

1.2.1 Operating Safety Information

Before switching on, ensure that the specified environmental conditions in the Specifications section (page 78) are complied with and that the power supply voltage corresponds with the voltage of the transmitter.

When there is a chance that safe operation is no longer possible, put the transmitter out of operation and secure against unintended operation.

1.2.2 Special Conditions of Use (FM Approval)

ACA592-XX transmitters are approved for connection to ABB conductivity sensor types:

2025	2278	TB26	TB452	TB464
2045	AC2	TB264	TB456	TB465
2077	TB25	TB27	TB457	TB468
2078	TB254	TB404	TB458	TB471
2085	TB256	TB451	TB461	TB475

1.3 Health & Safety

Health and Safety

To ensure that our products are safe and without risk to health, the following points must be noted:

- The relevant sections of these instructions must be read carefully before proceeding.
- Warning labels on containers and packages must be observed.
- Installation, operation, maintenance and servicing must only be carried out by suitably trained personnel and in accordance with the information given.
- Normal safety precautions must be taken to avoid the possibility of an accident occurring when operating in conditions of high pressure and / or temperature.

Safety advice concerning the use of the equipment described in this manual or any relevant Material Safety Data Sheets (where applicable) may be obtained from the Company address on the back cover, together with servicing and spares information.

1.4 Electrical Safety – IEC / EN 61010-1

This equipment complies with the requirements of IEC / EN 61010-1 'Safety Requirements for Electrical Equipment for Measurement, Control and Laboratory Use' and complies with applicable electrical codes NEC and CEC.

If the equipment is used in a manner NOT specified by the Company, the protection provided by the equipment may be impaired.

1.4.1 Electrical Installation Safety Information

Electrical connection may be performed only by authorized personnel according to the electrical codes of the country of destination.













Observe the electrical connection information in this publication. Failure to do so may affect the electrical protection of the transmitter.



The secure isolation of contact-dangerous electrical circuits is guaranteed only when the connected devices fulfil the requirements of the applicable electrical codes, or DIN VDE 0106 T.101 (basic requirements for secure isolation ['VDE' may not be applicable for NAM]).

For secure isolation, route the process supply lines separately from electrical circuits or additionally isolate them.

1.5 Symbols – EN / IEC 61010-1

One or more of the following symbols may appear on the equipment labelling:

	Protective earth (ground) terminal.
	Functional earth (ground) terminal.
	Direct current supply only.
	Alternating current supply only.
	Both direct and alternating current supply.
	The equipment is protected through double insulation.
	This symbol, when noted on a product, indicates a potential hazard which could cause serious personal injury and / or death. The user should reference this instruction manual for operation and / or safety information.
	This symbol, when noted on a product enclosure or barrier, indicates that a risk of electrical shock and / or electrocution exists and indicates that only individuals qualified to work with hazardous voltages should open the enclosure or remove the barrier.
	This symbol indicates that the marked item can be hot and should not be touched without care.
	This symbol indicates the presence of devices sensitive to electrostatic discharge and indicates that care must be taken to prevent damage to them.
	This symbol identifies a risk of chemical harm and indicates that only individuals qualified and trained to work with chemicals should handle chemicals or perform maintenance on chemical delivery systems associated with the equipment.
	This symbol indicates the need for protective eye wear.

	This symbol indicates the need for protective hand wear.
	Electrical equipment marked with this symbol may not be disposed of in European public disposal systems. In conformity with European local and national regulations, European electrical equipment users must now return old or end-of-life equipment to the manufacturer for disposal at no charge to the user.
	Products marked with this symbol indicates that the product contains toxic or hazardous substances or elements. The number inside the symbol indicates the environmental protection use period in years.

1.6 Product Recycling Information

	Electrical equipment marked with this symbol may not be disposed of in European public disposal systems after 12 August 2005. In conformity with European local and national regulations (EU Directive 2002 / 96 / EC), European electrical equipment users must now return old or end-of-life equipment to the manufacturer for disposal at no charge to the user.
---	---

Note. For return for recycling, please contact the equipment manufacturer or supplier for instructions on how to return end-of-life equipment for proper disposal.

1.7 Product Disposal

ABB, Inc. actively promotes environmental consciousness and has an operational management system in accordance with DIN EN ISO 9001, EN ISO 14001 and OHSAS 18001. Our products and solutions should have minimum impact on the environment and persons during manufacture, storage, transport, use and disposal. This includes the environmentally friendly use of natural resources. Through its publications ABB conducts an open dialog with the public.

The ACA592-XX transmitter is manufactured from materials that can be reused by specialized recycling companies.

Note. The following applies only to European customers.



ABB is committed to ensuring that the risk of any environmental damage or pollution caused by any of its products is minimized as far as possible. The European Waste Electrical and Electronic Equipment (WEEE) Directive (2002 / 96 / EC) that came into force on August 13 2005 aims to reduce the waste arising from electrical and electronic equipment; and improve the environmental performance of all those involved in the life cycle of electrical and electronic equipment.

In conformity with European local and national regulations (EU Directive 2002 / 96 / EC stated above), electrical equipment marked with the above symbol may not be disposed of in European public disposal systems after 12 August 2005.

1.7.1 Information on WEEE Directive 2002/96/EC (Waste Electrical and Electronic Equipment)

This product is **not** subject to the WEEE directive 2002/96/EC and relevant national laws (for example, ElektroG in Germany).

Dispose of the ACA592-XX transmitter directly in a specialized recycling facility. **Do not** use municipal garbage. Only privately used products may be disposed of in municipal garbage according to the WEEE directive 2002/96/EC. Proper disposal prevents negative effects on people and the environment, and supports the reuse of valuable raw materials.

If it is not possible to dispose of old equipment correctly, ABB Service will accept and dispose of returns for a fee.

1.8 Returning Transmitters

Use the original packaging or suitably secure packaging for returning the transmitter for repair or recalibration. Contact the local ABB office or sales representative for return authorization number and address.

All transmitters returned for service or repair to ABB must be free from any hazardous materials (acids, alkali, solvents, etc.).

1.8.1 Transport Safety Information

Observe the following information:

- Do not expose the transmitter to moisture during transport. Pack the transmitter accordingly.
- Pack the transmitter so that it is protected from vibration during transport, e.g. through air-cushioned packaging.

Check the transmitter for possible damage that may have occurred from improper transport. Damages in transit must be recorded on the transport documents. All claims for damages must be claimed against the shipper and before the installation.

1.9 Restriction of Hazardous Substances (RoHS)



The European Union RoHS Directive and subsequent regulations introduced in member states and other countries limits the use of six hazardous substances used in the manufacturing of electrical and electronic equipment. Currently, monitoring and control instruments do not fall within the scope of the RoHS Directive, however ABB has taken the decision to adopt the recommendations in the Directive as the target for all future product design and component purchasing.

1.10 Safety Precautions

Please read the entire manual before unpacking, setting up, or operating this instrument.

Pay particular attention to all warning and caution statements. Failure to do so could result in serious injury to the operator or damage to the equipment.

To ensure the protection provided by this equipment is not impaired, do not use or install this equipment in any manner other than that which is specified in this manual.

1.11 Safety Conventions

Warning. Indicates a condition which, if not met, could cause serious personal injury and / or death. Do not move beyond a warning until all conditions have been met.

If a warning sign appears on the instrument itself, refer to Precautionary Labels – product certification and Electrical Safety – EN / IEC 61010-1 for an explanation.

Caution. Indicates a condition which, if not met, could cause minor or moderate personal injury and / or damage to the equipment. Do not move beyond a caution until all conditions have been met.

Note. Indicates important information or instructions that should be considered before operating the equipment.

1.12 Safety Recommendations

For safe operation, it is imperative that these service instructions be read before use and that the safety recommendations mentioned herein be scrupulously respected. If danger warnings are not heeded to, serious material or bodily injury could occur.

1.13 Service and Repairs

Other than the serviceable items listed in Section 11, page 82, none of the transmitter's components can be serviced by the user. Only personnel from ABB or its approved representative(s) is (are) authorized to attempt repairs to the system and only components formally approved by the manufacturer should be used. Any attempt at repairing the instrument in contravention of these principles could cause damage to the instrument and corporal injury to the person carrying out the repair. It renders the warranty null and void and could compromise the correct working of the instrument and the electrical integrity or the CE compliance of the instrument.

If you have any problems with installation, starting, or using the instrument please contact the company that sold it to you. If this is not possible, or if the results of this approach are not satisfactory, please contact the manufacturer's Customer Service.

Note. The transmitter uses a capacitive touch display. Ensure the glass cover is kept in a clean condition to avoid contact problems caused by a dirty screen.

1.14 Potential Safety Hazards

The following potential safety hazards are associated with operating the system:

- Electrical (line voltage)
- Use in hazardous areas

2 Use in Areas Requiring Ignition Protection

Special regulations must be observed in explosion-protection zones for the auxiliary power connection, signal inputs/outputs and ground connection.

Caution.

- All parts must be installed in accordance with manufacturer information and relevant standards and regulations.
- Startup and operation must be performed in accordance with ATEX User Directive 99/92/EC or BetrSichV (EN60079-14).

2.1 Approvals

2.1.1 CE Mark

The ACA592-TE including type B LCD display / configuration software meets all requirements for the CE mark in accordance with applicable EC Directives 2004/108/EC (EMC), 2006/95/EC (LVD) and 94/9/EC (ATEX).

2.1.2 Ignition Protection

This transmitter is FM, CSA and ATEX/IEC approved – see Section 2.5, page 12 for hazardous area relevant information.

2.2 Ground

If for functional reasons, the intrinsically safe circuit must be grounded by connecting it to an equipotential bonding system, it must be grounded at a single location only.

2.3 Interconnection

If ACA592-XX transmitters are operated in an intrinsically safe circuit, proof of interconnection may be required during the installation. In general, intrinsically safe circuits require proof of interconnection.

2.4 Configuration

ACA592-XX transmitters can be installed in hazardous areas in compliance with proof-of-interconnection and directly in a hazardous area using approved handheld HART terminals (proof of interconnection may be required during the installation) as well as by coupling an ignition-proof modem to the circuit outside the explosion-protection area.

2.5 Hazardous Area Relevant Information

Note. The explosion-proof or ignition-proof designation is displayed on the agency certification label.

2.5.1 ACA592-XX.A1... (Intrinsic Safety)

ATEX/IECEx approved for use in zone 0/20.

Ex ia (Zone 0):

LCIE 11 ATEX 3058 X

IECEx LCI 11.0050X

Designation

Device design: II 1 G Ex ia IIC T4

Housing design: II 1 D Ex iaD A20 IP66 T135 °C, -20 °C ≤ T_{amb} ≤ 60 °C

Safety-relevant data

Input Parameters	
Maximum voltage	U _i = 30 V
Maximum input current	I _i = 160 mA
Maximum power	P _i = 0,8 W
Internal inductance	L _i = 0,5 mH
Internal capacitance	C _i = 5 nF

Table 2.1 Intrinsic Safety Input Parameters

Output Parameters	
Open-circuit voltage (maximum)	U _o = 11,8 V
Short-circuit current (maximum)	I _o = 5 mA
Maximum output power	P _o = 15 mW
Allowed inductance (total)	L _a = 1 H
Allowed capacitance (total)	C _a = 1.45 μF

Table 2.2 Intrinsic Safety Output Parameters

Notes.

- Parameters apply to entire system inclusive of cables.
- Each specified electrical parameter must be applied individually and in combination. Do not exceed the maximum values when applying the electrical parameters individually or in combination.
- Both Intrinsic safety and dust ratings are combined when ACA592-XX.A1... is ordered.

2.5.2 ACA592-XX.A2... (Flameproof Protection)

ATEX approved for use in Zone 1/21.

Ex d (Zone 1):

LCIE 11 ATEX 3057 X

IECEX LCI 11.0049X

Designation

Device design: II 2 G Ex d IIC T4

Housing design: II 2 D Ex tD A21 IP66 T135 °C, $-20\text{ °C} \leq T_{\text{amb}} \leq 60\text{ °C}$

Note. Both flameproof and dust ratings are combined when ACA592-XX.A2... is ordered.

2.5.3 ACA592-XX.A3... (Type n Non-sparking)

ATEX/IECEX approved for use in zone 2/22.

Ex nA (Zone 2):

LCIE 11 ATEX 1005 X

IECEX LCI 11.0048X

Designation

Device design: II 3 G Ex nA IIC T4

Housing design: II 3 D Ex tD A22 IP66 T135 °C, $-20\text{ °C} \leq T_{\text{amb}} \leq 60\text{ °C}$

Note. Both type n and dust ratings are combined when ACA592-XX.A3... is ordered.

ABB statement of conformity in accordance with ATEX directive.

2.5.4 ACA592-XX.F1 or .C1 (Intrinsic Safety)

Note. See installation drawings P0908 – FM (page 85), or P0910 – CSA (page 87) for allowable sensors.

Agency	Area Classification
FM	Class I, Div. 1, Groups A, B, C, D Class II/III, Div. 1, Group E, F, G; T4 Ta = 60 °C
CSA	Class I, Div. 1, Groups A, B, C, D Class II, Div. 1, Groups E, F, G Class III; Div. 1: T4

Table 2.3 Intrinsically Safe

Input Parameters	
Maximum voltage	$U_i = 30 \text{ V}$
Maximum input current	$I_i = 160 \text{ mA}$
Maximum power	$P_i = 0,8 \text{ W}$
Internal inductance	$L_i = 0,5 \text{ mH}$
Internal capacitance	$C_i = 5 \text{ nF}$

Table 2.4 Intrinsic Safety Input Parameters

Output Parameters	
Open-circuit voltage (maximum)	$U_o = 11.8 \text{ V}$
Short-circuit current (maximum)	$I_o = 5 \text{ mA}$
Maximum output power	$P_o = 15 \text{ mW}$
Allowed inductance (total)	$L_a = 1 \text{ H}$
Allowed capacitance (total)	$C_a = 1.45 \text{ }\mu\text{F}$

Table 2.5 Intrinsic Safety Output Parameters

Notes.

- Parameters apply to entire system inclusive of cables.
- Each specified electrical parameter must be applied individually and in combination. Do not exceed the maximum values when applying the electrical parameters individually or in combination.

2.5.5 ACA592-XX.F2 or .C2 (Explosion-proof)

Agency	Area Classification
FM	XP, Class I, Div. 1, Groups A, B, C, D Class II/III, Div. 1, Group F, G; T4 Ta = 60 °C
CSA	Class I, Div. 1, Groups A, B, C, D Class II, Div. 1; Groups E, F, G Class III; Div. 1; T4

Table 2.6 Explosion-proof

2.5.6 ACA592-XX.F3 or .C3 (Non-incendive)

Note. See installation drawings P0909 – FM (page 86), or P0911 – CSA (page 88) for allowable sensors.

Agency	Approvals
FM	Class I, Div. 2, Groups A, B, C, D Class II/III, Div. 2, Group F, G; T4 Ta = 60 °C
CSA	Class I, Div. 2, Groups A, B, C, D Class II, Div. 2, Groups F, G Class III; Div 2; T4

Table 2.7 Non-incendive

Input Parameters	
Maximum voltage	U _i = 30 V
Maximum input current	current controlled by transmitter
Internal inductance	L _i = 0,5 mH
Internal capacitance	C _i = 5 nF

Table 2.8 Non-incendive Field Wiring – FM and CSA: Input Parameters

Note. For installation not using Associated Equipment, maximum voltage is 42 V DC and input wiring must be installed per Div. 2 wiring methods in accordance with the applicable Electrical Code of the country in use.

Output Parameters	
Open-circuit voltage (maximum)	$U_o = 11.8 \text{ V}$
Short-circuit current (maximum)	$I_o = 5 \text{ mA}$
Maximum output power	$P_o = 15 \text{ mW}$
Allowed inductance (total)	$L_a = 1 \text{ H}$
Allowed capacitance (total)	$C_a = 1.45 \text{ }\mu\text{F}$

Table 2.9 Non-incendive Field Wiring – FM and CSA: Output Parameters

Notes.

- Parameters apply to entire system inclusive of cables.
- Each specified electrical parameter must be applied individually and in combination. Do not exceed the maximum values when applying the electrical parameters individually or in combination.

3 Mechanical Installation

3.1 Hazardous Area Installation

For hazardous area designation, the Ex installation is described on a separate 'HazLoc' label mounted on the transmitter body – see Section 3.4.5, page 23.

For protection in Ex d / explosion-proof installations, turn the 2 security screws (located beneath the covers on front and rear of the housing body) until they prevent both covers from being rotated (unscrewed) therefore preventing removal of the covers.

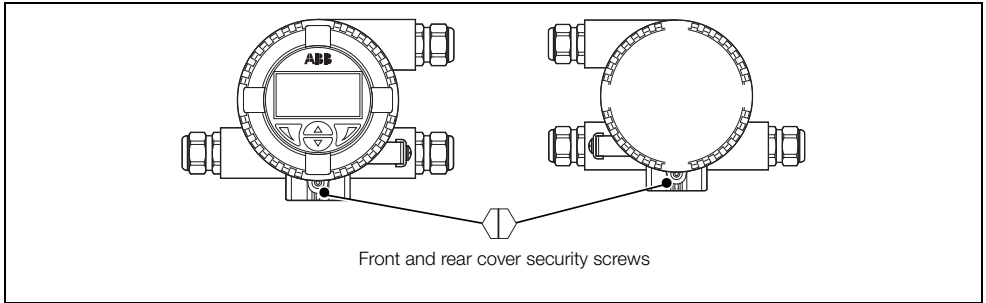

Fig. 3.1 Transmitter Cover Security Screws

3.2 Non-hazardous area installation

Fig. 3.2 shows a general purpose non-hazardous installation and is for reference only.

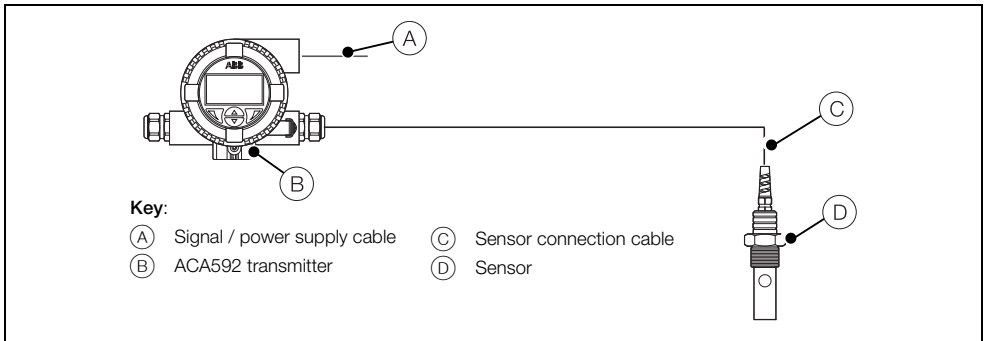

Fig. 3.2 Installation in Non-Hazardous Area

3.3 Installation Conditions

Ensure the following installation conditions are met:

1. Install the transmitter with consideration to ambient conditions.
2. Locate the transmitter in a position where the temperature and humidity specifications are not exceeded and ensure the transmitter is protected from direct sunlight, rain, snow and hail.
3. Ensure the transmitter operating temperature is within the range -20 to 60 °C (-4 to 140 °F).
4. Select a location away from strong electrical and magnetic fields.

3.4 Dimensions

3.4.1 Transmitter-only Dimensions (Excluding Mounting Bracket)

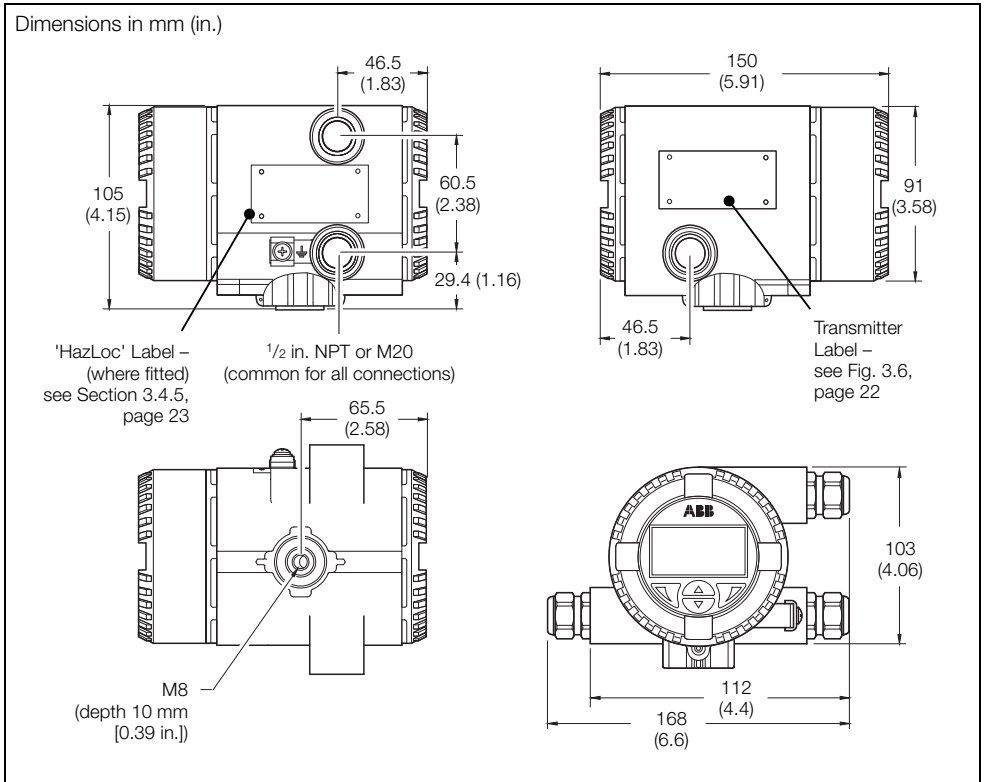

Fig. 3.3 Transmitter-only Dimensions

3.4.2 Wall-mount Transmitter Dimensions

Warning. Install the wall-mounting bracket on a sufficiently stable wall.

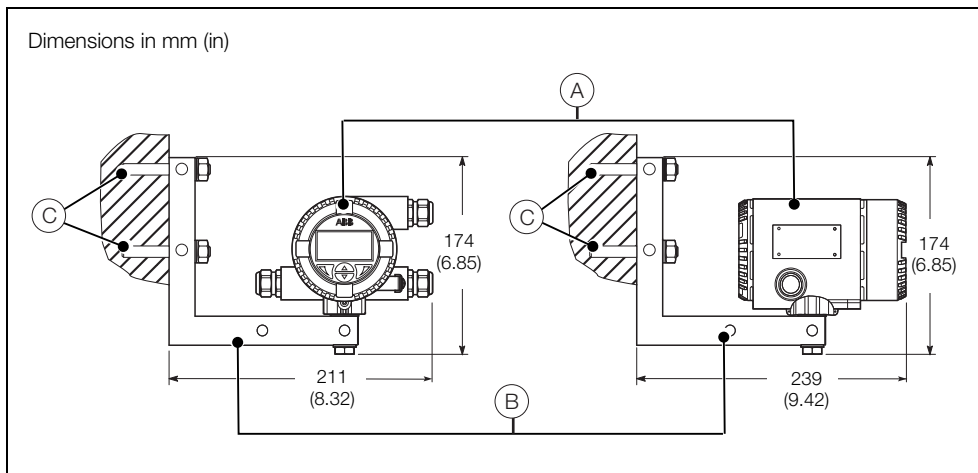

Fig. 3.4 Wall Installation

Wall-mounting an ACA592 transmitter

Referring to Fig. 3.4:

1. Select a location as close as possible to the sensor.
2. Bolt the transmitter (A) to the wall-mounting bracket (B) securely in the required position.

Note. The wall-mounting bracket (B) supports variable installation positions. 2 examples of the different options are shown in Fig. 3.4. The mounting bolt enables adjustable positioning (0° to 360°) of the transmitter housing.

3. Attach the wall-mounting bracket (B) to the wall securely using 2 x 10 mm bolts (C).

3.4.3 Pipe-mount Transmitter Dimensions

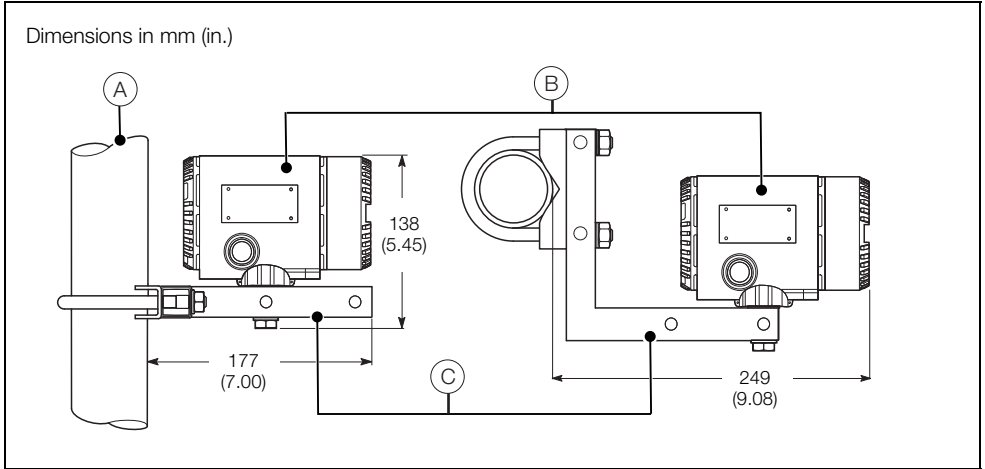

Fig. 3.5 Pipe Installation

Pipe-mounting an ACA592 transmitter

Referring to Fig. 3.5:

1. Select a suitable pipe (A) (maximum 50 mm [2 in.]) as close as possible to the sensor.
2. Bolt the transmitter (B) to the pipe-mounting bracket (C) securely in the required position.

Note. The pipe-mounting bracket (C) supports variable installation positions. Two examples of the different options are shown in Fig. 3.5. The transmitter mounting bolt enables adjustable positioning (0° to 360°) of the transmitter housing.

3. Attach the pipe-mounting bracket (C) to the pipe securely using the U-bolt, nuts and washers (included).

3.4.4 Transmitter Label

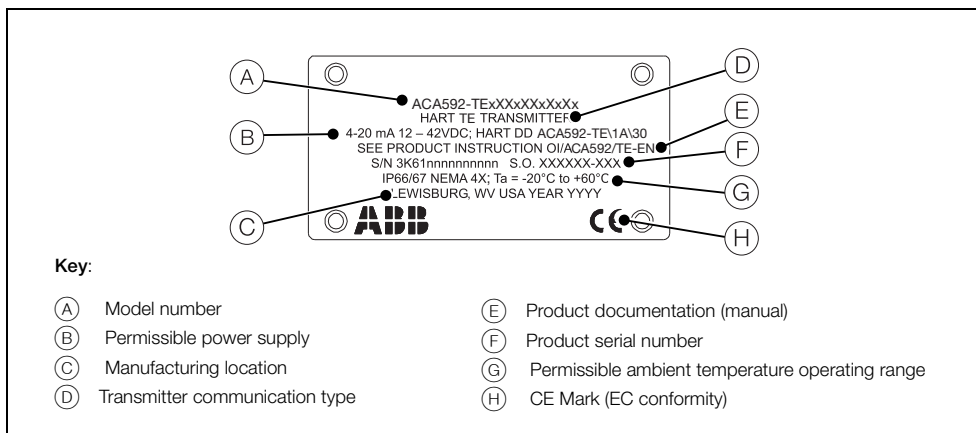

Fig. 3.6 Example of ACA592 2-Electrode Conductivity Transmitter Label

Note. The temperature range (G) refers to the permissible ambient temperature range for the transmitter **only** and not to the measuring element used.

3.4.5 'HazLoc' Labels

ATEX (Zone 0, Zone 1, Zone 2) Label

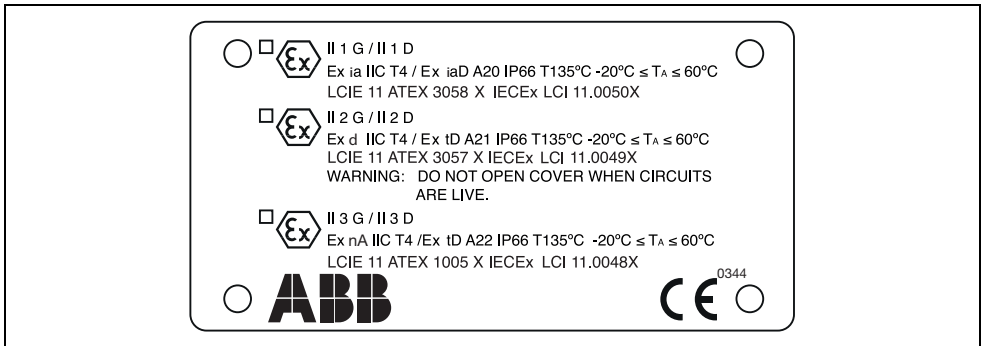

Fig. 3.7 Example of ATEX (Zone 0, Zone 1, Zone 2) 'HazLoc' Label

CSA / FM (Classes I, II, III; Div. 1 Intrinsic Safety and Div. 2 Non-incendive) Label

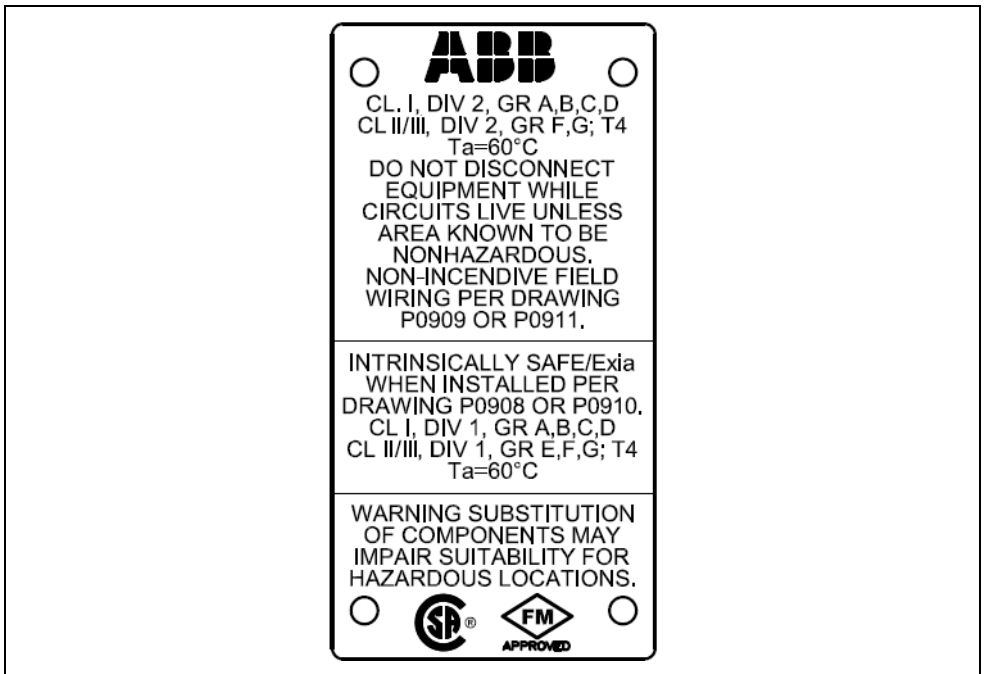

Fig. 3.8 Example of CSA / FM (Classes I, II, III; Div. 1 Intrinsic Safety and Div. 2 Non-incendive) 'HazLoc' Label

CSA / FM (Classes I, II and III; Div. 1 explosion- and ignition-proof) Label



Fig. 3.9 Example of CSA / FM (Classes I, II and III; Div. 1 explosion- and ignition-proof) 'HazLoc' Label

3.4.6 Aligning the Cartridge LCD Display

Warning. Isolate the transmitter from power supplies before aligning the cartridge LCD display.

Because the transmitter's mounting bracket enables the transmitter housing to be positioned in 90 ° steps only between 0 and 360 °, it may be necessary to re-position the cartridge to ensure the cartridge LCD display is readable when mounted.

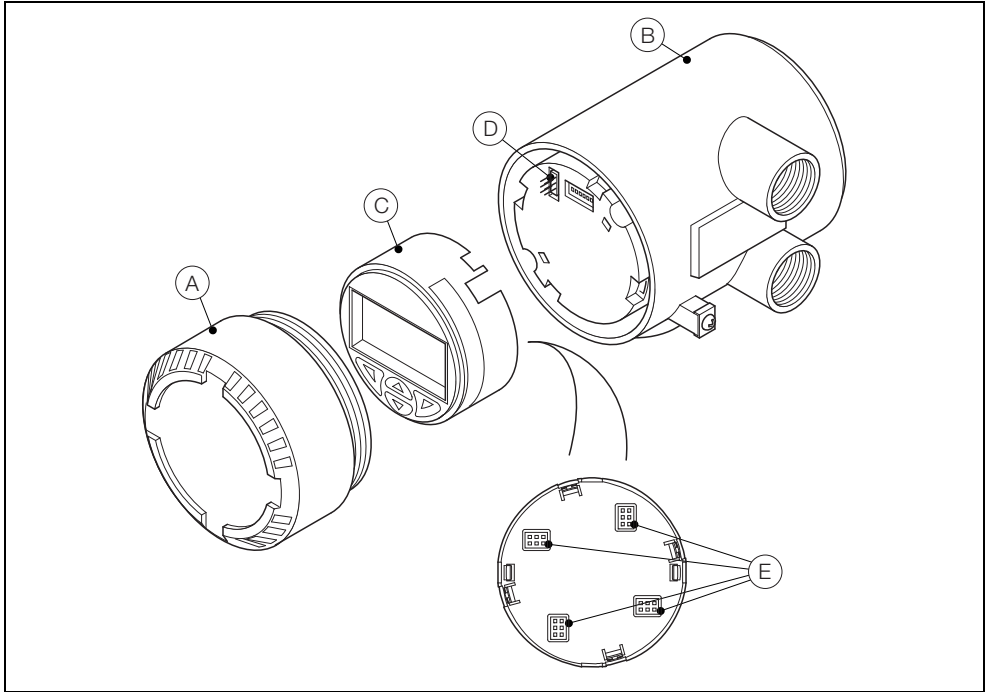

Fig. 3.10 LCD Display Alignment

To align the display:

1. Unscrew the cartridge cover (A) and remove it from the transmitter (B).
2. Depress the 4 locking lugs on the side of the cartridge (C) one at a time.
3. Pull the cartridge (C) carefully but firmly out of the transmitter (B) keeping it straight to avoid bending the 6-pin connector (D).
4. Align one of the 4 plug positions (E) on the rear of the cartridge (C) with the 6-pin connector (D) to ensure the cartridge LCD display is readable when mounted.
5. Refit the cartridge (C) in the new position by pushing it carefully but firmly into the transmitter. Keep the cartridge (C) straight to avoid bending the 6-pin connector (D).
6. Refit the cartridge cover (A) by screwing it until the O-ring is slightly compressed onto the transmitter (B).

4 Electrical Installation

Warning.

- Observe all local instructions and regulations governing electrical installation. Ensure the power supply and / or bus connections are switched off before making connections.
- Use a maximum of 12 SWG (10 AWG) wire for connection of this transmitter.
- Ensure connection to protective earth.
- Do not apply power until installed.
- The transmitter is not fitted with a switch and does not have overvoltage protection devices, lightning protection or voltage separation capacity therefore these must be provided on the plant side.
- Power supplies and signals are routed in the same line and must be implemented as SELV or PELV circuits according to requirements (standard version). In the ignition-proof version, the guidelines regarding the ignition-proof requirements must be adhered to.
- Ensure the existing power supply corresponds with the specifications on the name plate and the technical specifications – see Section 10, page 78.
- Use only signal cable wires with tinned or wire end sleeves.

4.1 Cable Glands and Plugs

4.1.1 ACA592–XX for Intrinsically Safe, Type n, and Non-incendive Installations

Non-Ex d transmitters are supplied with a nylon conduit plug and cable gland. The cable gland is sized to provide a tight seal around the sensor cable.

If a customer-supplied cable gland and plug is used, the cable diameter for the cable gland used must comply with the requirements for IP/NEMA 4X protection. This must be checked during installation.

4.1.2 ACA592–XX Ex d Models without Cable Gland

ACA592–XX Ex d / explosion-proof rated transmitters are supplied with a standard 316 stainless steel rated plug.

Hazardous area 316 stainless steel $\frac{1}{2}$ in. NPT or M20 cable glands must be ordered as an accessory based on the hazardous area installation requirements.

Note. For ATEX installations, an approved ATEX Ex d cable gland must be used according to EN 60079-1. For FM and CSA installations, an approved Ex d cable gland must be used.

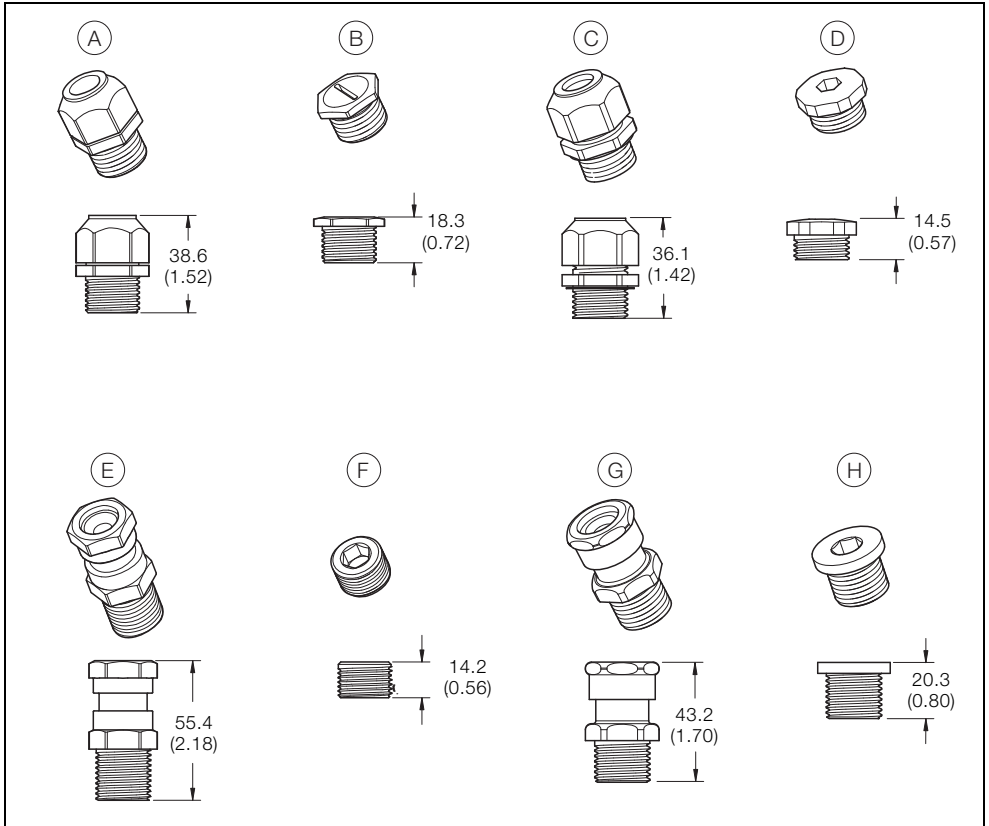

Fig. 4.1 Cable Glands and Plugs

Item	Description
(A)	1/2 in. NPT nylon cable gland
(B)	1/2 in. NPT nylon conduit plug
(C)	M20 nylon cable gland
(D)	M20 nylon conduit plug
(E)	1/2 in. NPT 316 stainless steel Ex d (explosion-proof) cable gland
(F)	1/2 in. NPT 316 stainless steel Ex d (explosion-proof) conduit plug
(G)	M20 316 stainless steel Ex d (explosion-proof) cable gland
(H)	M20 316 stainless steel Ex d (explosion-proof) conduit plug

Table 4.1 Cable Glands and Plugs – Descriptions

4.2 DC Power Supply Connections

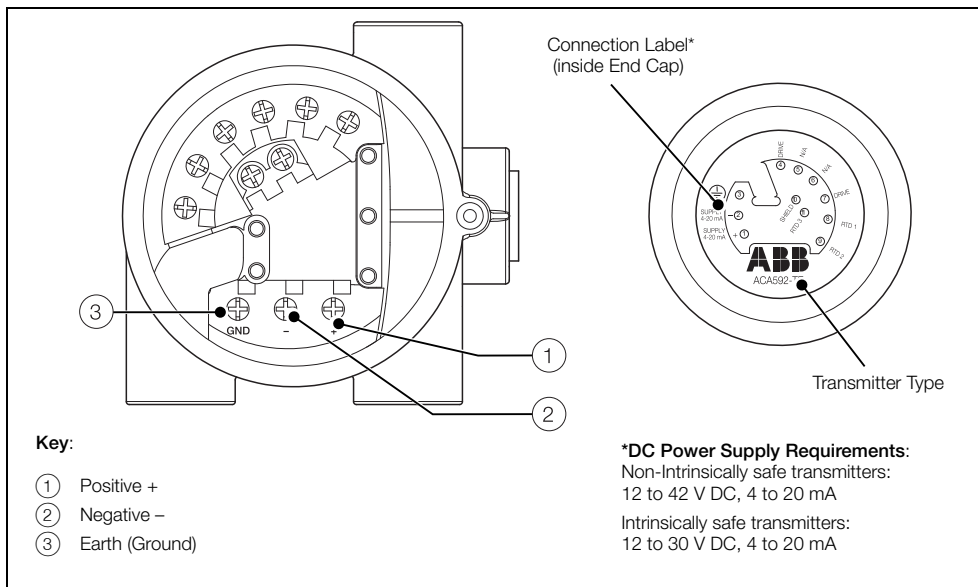

Fig. 4.2 Power Supply Connections at Transmitter Terminals

Note. HART Communication

Communication with the transmitter is supported by the HART protocol. The communication signal is modulated on both wires for the power supply line and decoded by the transmitter. The electrical connection is provided at the (+) and (-) terminals of the transmitter or by the power supply cable that is installed on-site.

To connect the HART power supply:

1. Route the power supply wiring through one of the three threaded connections in the transmitter housing.
2. Strip the wires and tin or attach wire end sleeves.
3. Loosen the power supply terminal captive screws (①), (②) and (③) using a flat-bladed screwdriver (3.5 / 4 mm or Size-1).
4. Connect the (+) wire to the (+) terminal (①).
5. Connect the (-) wire to the (-) terminal (②).
6. Connect the cable shield or earth (ground) wire to the earth (ground) terminal (③) (if required).

4.3 Sensor Connections

Caution.

- The connection terminals accept cables up to a maximum peripheral wire cross section of 2.5 mm² (12 SWG [10 AWG]).
- Do not use a rigid conductor material as this can result in wire breaks.
- Ensure the connecting cable is flexible.
- To ensure the sensor cable length is sufficient, allow an additional 100 mm (4 in.) of cable to pass through cable glands and into the housing.
- Ensure the correct connections are made to suit the transmitter variant – ACA592-TE (see Section 4.3.1, page 30).

4.3.1 ACA592 2-Electrode Conductivity Transmitter – Sensor Connections

To connect the sensor:

1. Refer to Table 4.2 to identify the correct cable wires for the ACA592-TE 2-electrode conductivity transmitter.
2. Route the sensor wiring through one of the three threaded connections in the transmitter housing and use an appropriated cable gland (refer to Fig. 4.1, page 27 for gland options). Note, a cable gland must be used
3. Loosen the sensor connection terminal captive screws using a a flat-bladed screwdriver (3.5 / 4 mm or Size-1).
4. Insert each sensor cable wire under the open terminals and secure by tightening the terminal captive screws.

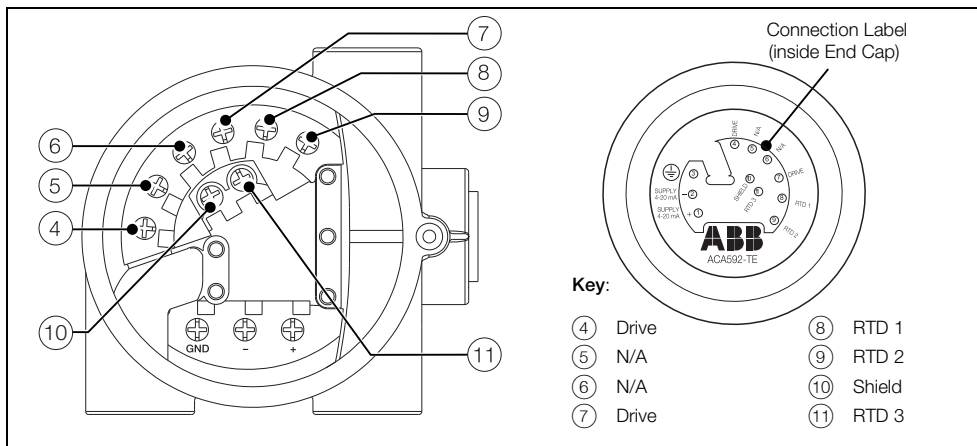

Fig. 4.3 ACA592-TE 2-Electrode Conductivity Transmitter – Sensor Connections at Transmitter Terminals

Connection Information		Sensor Cable Color							
Terminal	Function	2025	2045	2077	2078	2085	2278	AC4	TB2
4	Drive	Red	Red	Red	Red	Red	Green	Green	Green
5	N/A	None	None	None	None	None	None	None	None
6	N/A	None	None	None	None	None	None	None	None
7	Drive	Black	Black	Black	Black	Black	Black	Black	Black
8	RTD 1	Green / Yellow & Blue	Green / Yellow, Blue	Green / Yellow, Blue	Green / Yellow, Blue	Green / Yellow, Blue	Blue	Blue	Blue
9	RTD 2	Brown	Brown	Brown	Brown	Brown	Yellow	Yellow	Yellow
10	Shield	None	None	None	None	None	Dark Green	Dark Green	Dark Green
11	RTD 3	None	None	None	None	None	None	None	None

Table 4.2 ACA592-TE Compatible Sensor Cable Colors

4.4 Integral Sensor Cable Connection

For installations where the sensor is close to the transmitter, use an integral c cable. This design is preferred for submersible installations as there is no connector that could be affected by moisture.

For ease of sensor replacement, keep the cable length to a minimum.

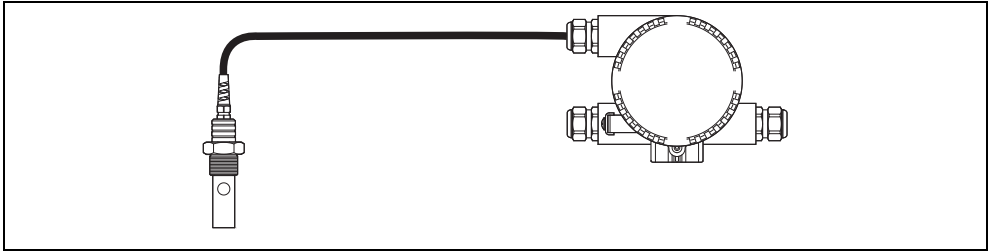

Fig. 4.4 Sensor with Integral Cable

4.5 Junction Box and Extension Cable Connection

For some applications, an extension cable is available that can be installed permanently between the sensor and the transmitter. The sensor has a junction box mounted either directly on it or in close proximity. The extension cable is connected to the sensor inside the junction box.

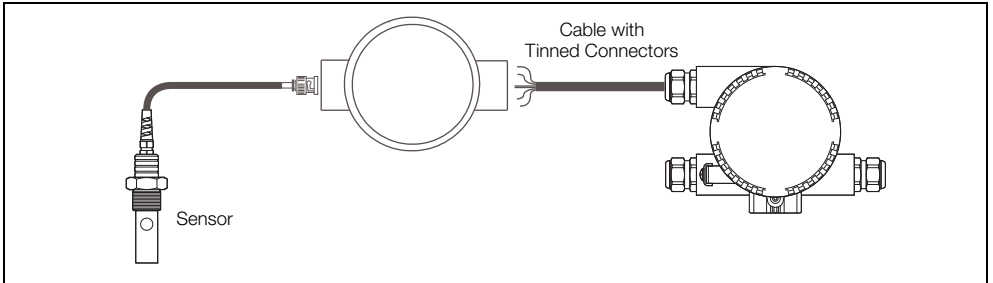

Fig. 4.5 Sensor with Junction Box and Extension Cable

4.6 Power Supply Requirements

Warning.

- The connection terminals accept cables with a maximum peripheral wire cross-section of 2.5 mm² 12 SWG (10 AWG).
- Switch off the power supply before connecting the transmitter.

Notes.

- To ensure the sensor cable length is sufficient, allow an additional 100 mm (4 in.) of cable to pass through cable glands and into the housing.
- Use stranded conductor material for the power supply cable.
- Ensure the connecting cable is flexible.
- Do not use a rigid conductor material as this can result in wire breaks.

4.6.1 Standard Application

When connecting ACA592-XX transmitters and power supplies in non-hazardous areas, observe the following specification:

$$U_{Smin} > U_{Mmin} + 0.022A \times R_{Ltg}$$

Where:

- U_{Mmin} – Minimum operating voltage of transmitter (refer to technical data for transmitter)
- U_{Smin} – Minimum supply voltage of power supply/SPS input (refer to technical data for transmitter)
- R_{Ltg} – Line resistance between transmitter and power supply

For HART functionality, use power supplies or SPS input cards with HART mark. If this is not possible, the interconnection must have a resistance. 250 Ω is required by HART standard.

Earth (ground) connection – when connecting the earth (ground) (minus side), ensure that only one side of the contact is connected to an equipotential bonding system.

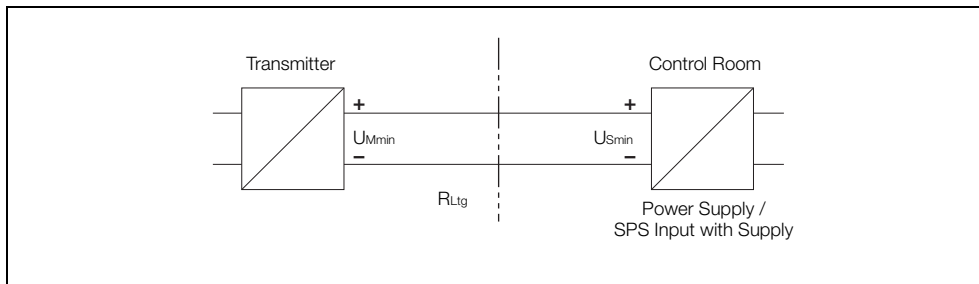

Fig. 4.6 Standard Application

4.6.2 Standard Application with HART Functionality

Adding resistance R_{250} increases the minimum supply voltage:

$$U_{Smin} > U_{Mmin} + 0.022A \times (R_{Ltg} + R_{250})$$

Where:

- U_{Mmin} – Minimum operating voltage of transmitter
(refer to technical data for transmitter)
- U_{Smin} – Minimum supply voltage of power supply/SPS input
(refer to technical data for transmitter)
- R_{Ltg} – Line resistance between transmitter and power supply
- R_{250} – Resistance for HART functionality

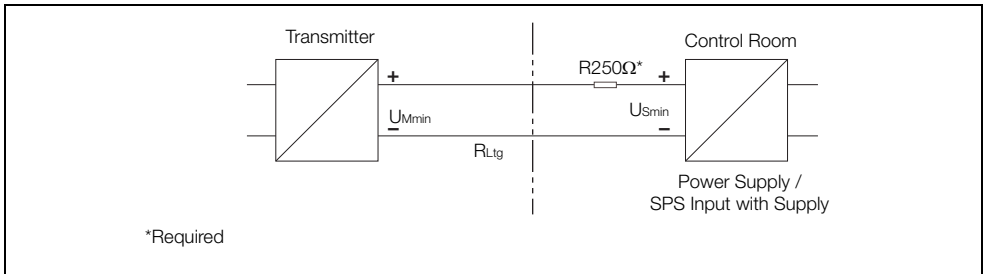

Fig. 4.7 Standard Application with HART Functionality

4.6.3 Electrical Connection in Hazardous Area

Special interconnections are required for use in hazardous areas depending on the safety requirements.

Caution. Refer to Section 2, page 11 and Section 10, page 78 for explosion risk area requirements.

Intrinsic safety

The power supply SPS inputs must have corresponding input protection circuits available to eliminate spark hazards. An interconnection inspection must be performed. For proof of intrinsic safety, the electrical limit values must be used as the basis for the prototype test certificates of the transmitters, including the capacitance and inductance values of the wires. Proof of intrinsic safety is granted if the conditions in Table 4.3 are fulfilled.

ACA592-XX (Intrinsically Safe Transmitter)		Power Supply/SPS Input (Related Apparatus)
U_i	\geq	U_o
I_i	\geq	I_o
P_i	\geq	P_o
$L_i + L_c$ (cable)	\leq	L_o
$C_i + C_c$ (cable)	\leq	C_o

Table 4.3 Intrinsic Safety Conditions

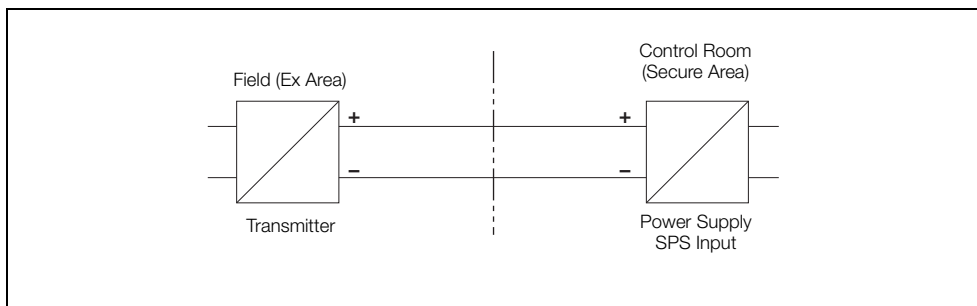

Fig. 4.8 Explosion Risk Area Application

4.6.4 Installation in Hazardous Areas

ACA592–XX transmitters can be installed in a wide variety of industrial sectors. Systems that require ignition protection are divided into zones. As a result, different instruments are also required.

Note. For additional information, refer to Section 2.5, page 12.

Figs 4.9 to 4.15, page 38 provide details of installations in ATEX / IEC Ex areas.

Intrinsic Safety – ATEX / IEC Ex

II 1 G Ex ia IIC T4

II 1 D Ex ia D A20 IP66 T135 °C, $-20\text{ °C} \leq T_{\text{amb}} \leq 60\text{ °C}$

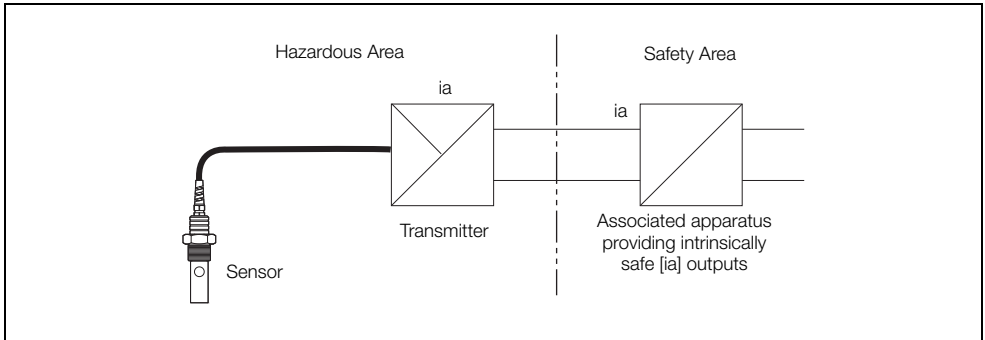

Fig. 4.9 Intrinsic Safety – ATEX/IEC Ex

Intrinsic Safety – FM and CSA

Entity parameters are specified in Appendix B, installation drawing P0908

<p>FM</p> <p>Class I, Div. 1, Groups A, B, C, D</p> <p>Class II/III, Div. 1, Group E, F, G;</p> <p>T4 Ta = 60 °C</p>	<p>CSA</p> <p>Class I, Div. 1, Groups A, B, C, D</p> <p>Class II, Div. 1, Groups E, F, G</p> <p>Class III, Div. 1; T4</p>
--	---

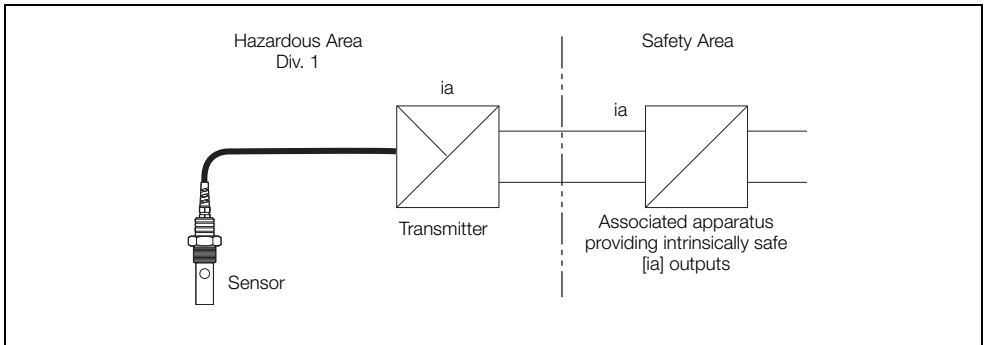

Fig. 4.10 Intrinsic Safety – FM and CSA

Type n (Non-sparking) – ATEX/IEC Ex

II 3 G Ex nA IIC; T4

II 3 D Ex tD A22 IP66 T135 °C, $-20\text{ °C} \leq T_{\text{amb}} \leq 60\text{ °C}$

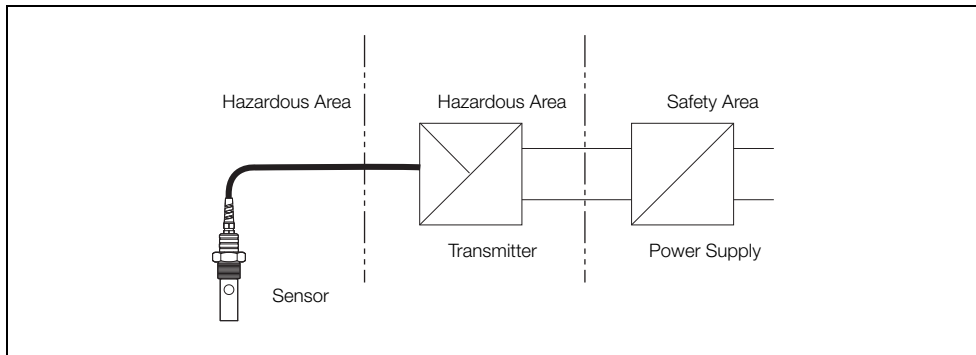

Fig. 4.11 Type n (Non-sparking) – ATEX/IEC Ex

Non-Incendive (Using Non-incendive Field Wiring) – FM and CSA

Entity parameters are specified in Appendix B, installation drawing P0909

FM	Class I, Div. 2, Groups A, B, C, D	CSA	Class I, Div. 2, Groups A, B, C, D
	Class II/III, Div. 2, Group F, G; T4		Class II, Div. 2, Groups F, G
	Ta = 60 °C		Class III, Div. 2; T4

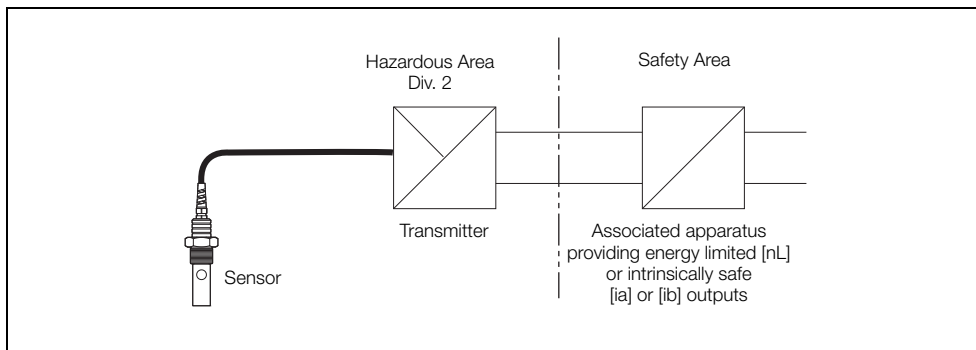

Fig. 4.12 Non-Incendive (using non-incendive field wiring) – FM and CSA

Non-Incendive (using Div. 2 field wiring) – FM and CSA

Note. Local regulations for the power supply must be observed and approved wiring methods for Div. 2 hazardous classified locations must be used.

<p>FM Class I, Div. 2, Groups A, B, C, D Class II/III, Div. 2, Group F, G; T4 Ta = 60 °C</p>	<p>CSA Class I, Div. 2, Groups A, B, C, D Class II, Div. 2, Groups F, G Class III, Div. 2; T4</p>
---	--

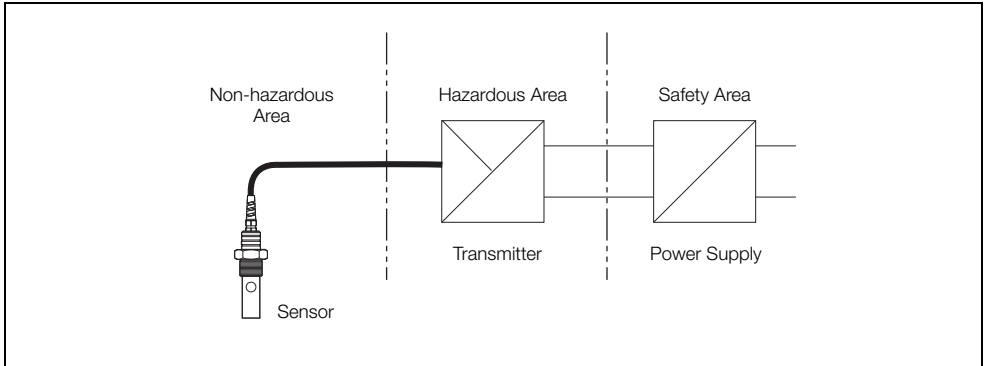

Fig. 4.13 Non-Incendive (using Div. 2 field wiring) – FM and CSA

Flameproof – ATEX

Note. Local regulations governing the installation of the power supply and the sensor must be observed. Do not open the cover when circuits are live.

II 2 G Ex d IIC T4
II 2 D Ex tD A21 IP66 T135 °C, -20 °C ≤ T_{amb} ≤ 60 °C

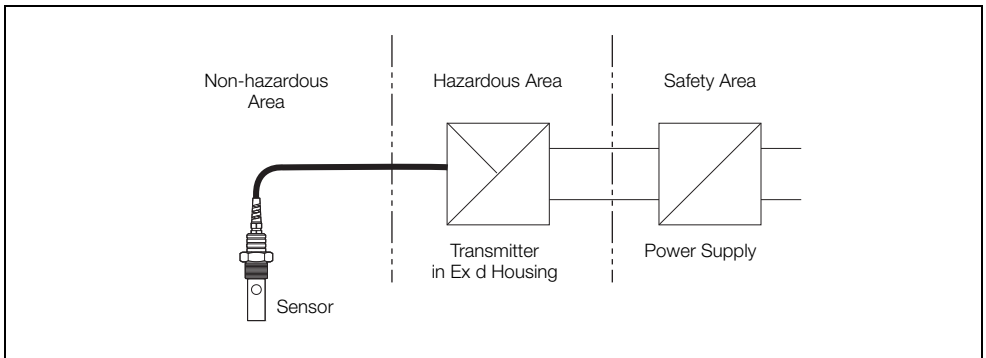

Fig. 4.14 Flameproof – ATEX

Explosion-proof, Dust-Ignition-proof – FM and CSA

Note. Local regulations governing the installation of the power supply and the sensor must be observed. Do not open the cover when circuits are live.

FM	XP, Class I, Div. 1, Groups A, B, C, D DIP, Class II, Div. 1, Groups E, F, G DIP, Class III, Div. 1; T4	CSA	Class I, Div. 1, Groups A, B, C, D Class II, Div. 1, Groups E, F, G Class III, Div. 1; T4
----	--	-----	---

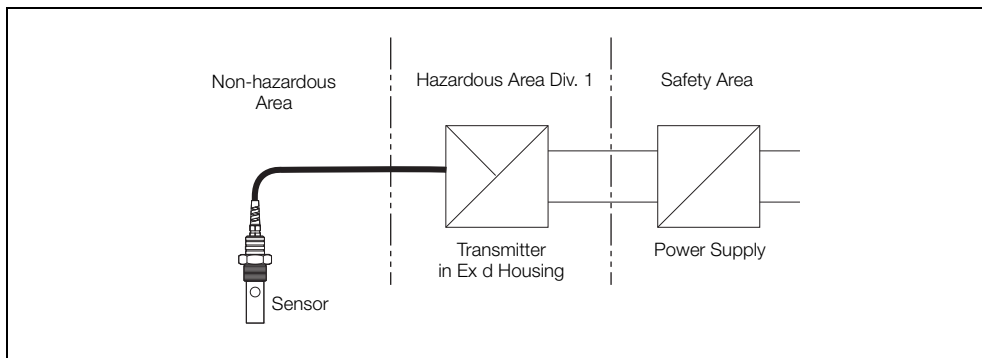

Fig. 4.15 Explosion-proof, Dust-ignition-proof – FM and CSA

5 Start-up and Operation

5.1 Navigating Menus and Parameters

The four keys below the display are used to navigate menus and to execute all system commands and selections.

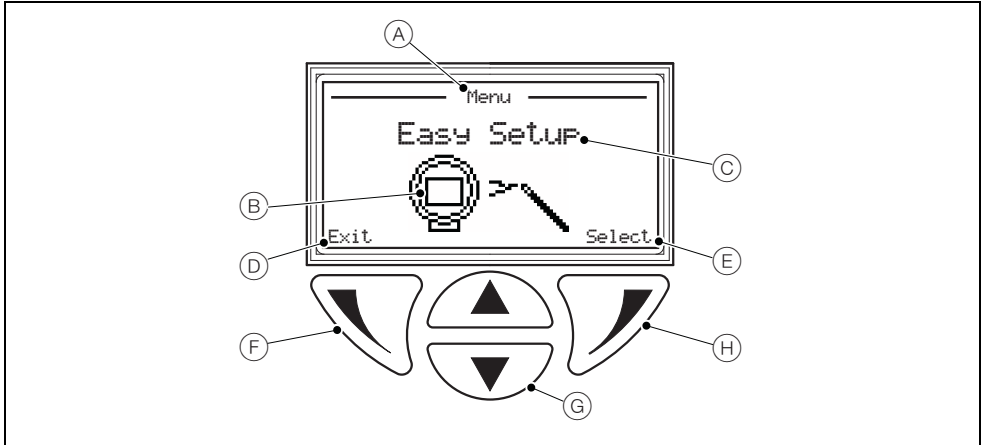



Fig. 5.1 Display and Keys

Item	Description
(A)	Screen title at the current level / parameter
(B)	Main level icon
(C)	Menu level title
(D)	Prompt executed by pressing the  key
(E)	Prompt executed by pressing the  key
(F)	Left key – used for parameter navigation and to enter editable parameters
(G)	Up / Down keys – used to scroll through menu options and to increase / decrease values in editable parameters
(H)	Right key – used to accept / select parameter values / selections and exit sub-levels

Note. The transmitter uses a capacitive touch display. The capacitive keys are calibrated with the glass cover during initial power up. If problems occur when using the keys, power the transmitter down and power up again to allow the unit to recalibrate the keys with the glass cover.

5.2 Security Levels and Password Access

At power-up, the *Start-up Display* and process display (*Operator Page*) screens are activated in sequence.

Note.

- Passwords at *Standard / Advanced* level are disabled by default. They can be enabled and disabled independently by end-users via the *Service* level.
- To navigate from the *Operator Page(s)* directly back to the menus, accept the default access level selection at the *Access Level* screen and press the  key.

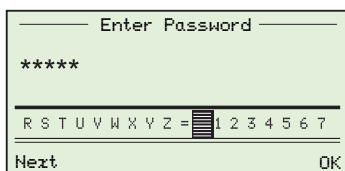
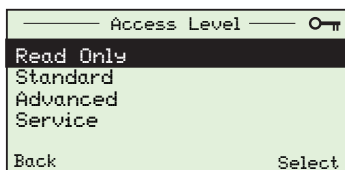

Operator Pages (Process Display)

When the start-up routine is completed the process display (*Operator Page*) screen is displayed.

Press the  key to display the *Access Level* screen where the level of user access is selected.

Access Level

Access to the *Read Only* level does not require a password.

Standard and *Advanced* access levels do not require passwords by default, however, passwords for these levels can be enabled via the *Service* level.







Access to the *Service* level is password-dependent.

The *Enter Password* screen is always displayed for *Service* level access. It is also displayed for *Standard* and *Advanced* level access when the corresponding passwords are enabled.

The *Enter Password* screen is not displayed when accessing *Read Only* level.

Enter Password

To select password characters and enter passwords:

1. Use the  and  keys to scroll to and highlight the first password character to be selected.
2. Press the  key to select the highlighted character (add it to the password set).
3. Use the  and  keys to highlight the next password character to be selected.
4. Repeat steps 2 to 4 until all characters have been added to the password.
5. Press the  key to accept the password and display menus available at the requested access level.

Note. If a time-out occurs (after 5 minutes of no activity), enter the password again to access menus at the same level.

5.2.1 Security Permissions

Table 5.1 (below) provides an overview of the permissions enabled at each access level:

Access Level	Read / Write	Read-only
Read-only	None	All levels and sub-levels
Standard*	<ul style="list-style-type: none"> ■ Calibrate ■ Input / Output ■ Display ■ Diagnostics 	<ul style="list-style-type: none"> ■ Easy Setup ■ Device Setup ■ Communication ■ Service
Advanced*	<ul style="list-style-type: none"> ■ Easy Setup ■ Calibrate ■ Device Setup ■ Input / Output ■ Display ■ Diagnostics ■ Communication 	<ul style="list-style-type: none"> ■ Service
Service	<ul style="list-style-type: none"> ■ Easy Setup ■ Calibrate ■ Device Setup ■ Input / Output ■ Display ■ Diagnostics ■ Communication ■ Service 	–

Table 5.1 Overview of Security Permissions

*Standard and Advanced Level passwords are enabled / disabled via the Service Level.

5.2.2 Default Passwords





The transmitter is supplied with factory-set (default) passwords for access to the *Standard*, *Advanced* and *Service* levels. Passwords cannot be modified.

5.3 Configuration Menus Overview

Note. Parameters displayed are dependent on the option selected at the *Analyzer Type* parameter.

The following measurement-specific parameters are available:

- 2-Electrode / Conductivity – see Section 7.2.1, page 50
- 2-Electrode / Concentration – see Section 7.2.2, page 51

To access menus from an *Operator Page*, press the  key (beneath the  icon) and select the required level of access (enter a user password if necessary). To scroll between menus, press the  and  keys.





Display Overview	Section and Function
 <p>The screenshot shows a green screen with 'Menu' at the top left and '1' at the top right. The main text is 'Easy Setup'. Below it is an icon of a device with a pencil. At the bottom left is 'Exit' and at the bottom right is 'Select'.</p>	<p>Easy Setup</p> <p>The <i>Easy Setup</i> menu is used to set up the system quickly and contains a series of options for users with <i>Advanced</i> level access permission.</p> <p>Users with <i>Read Only</i> and <i>Standard</i> access have read-only permissions and cannot make selections from this menu.</p>
 <p>The screenshot shows a green screen with 'Menu' at the top left and '2' at the top right. The main text is 'Calibrate'. Below it is an icon of a dial and a key. At the bottom left is 'Exit' and at the bottom right is 'Select'.</p>	<p>Calibrate</p> <p>Used to calibrate the transmitter.</p>
 <p>The screenshot shows a green screen with 'Menu' at the top left and '3' at the top right. The main text is 'Device Setup'. Below it is an icon of a device with a key and a vertical bar. At the bottom left is 'Exit' and at the bottom right is 'Select'.</p>	<p>Device Setup</p> <p>Used to specify temperature sensor and sensor data settings.</p>
 <p>The screenshot shows a green screen with 'Menu' at the top left and '4' at the top right. The main text is 'Input/Output'. Below it is an icon of a device with a waveform. At the bottom left is 'Exit' and at the bottom right is 'Select'.</p>	<p>Input/Output</p> <p>Used to setup logic states, pulse states and current output settings.</p>
 <p>The screenshot shows a green screen with 'Menu' at the top left and '5' at the top right. The main text is 'Display'. Below it is an icon of a device with a box containing the number '123'. At the bottom left is 'Exit' and at the bottom right is 'Select'.</p>	<p>Display</p> <p>Enables screen settings, language selection and the display format to be specified.</p>

Table 5.2 Operating Menus Overview

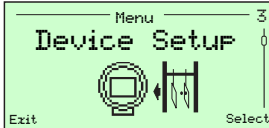

Display Overview	Section and Function
	<p>Diagnostics</p> <p>Used to test / fix the output current in loop mode and view the diagnosis simulation status.</p>
	<p>Communication</p> <p>Used to configure the transmitter's HART communication support.</p>
	<p>Service</p> <p>Note. Service level parameters are reserved for ABB factory-trained personnel – contact the Company for support.</p>

Table 5.2 Operating Menus Overview (Continued)

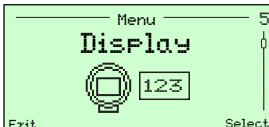
6 Configuration

6.1 Configuration Options

ACA592 transmitter configuration options comprise:

- Configuration via the transmitter's navigation keys.

Note.

- Complete configuration of the transmitter is available through the HMI. However, not all transmitter DTM functions (for example, such as Diagnosis Masking) are accessible via the transmitter's navigation keys.
- Communication with the transmitter is supported by the HART protocol – refer to Section 9, page 71 for HART commands.

- Configuration via FDT/DTM technology.

Configuration can be performed with any FDT network applications that are approved for use with the DTM (for example, ABB AssetVision Basic / Professional). The bus can be connected via FSK modem as well as HART + USB or HART Multiplexer.

- Configuration via EDD technology.

Configuration can also be performed with EDD master applications such as Siemens Simatic PDM, that is approved for use with EDD.

- Configuration using a handheld terminal.

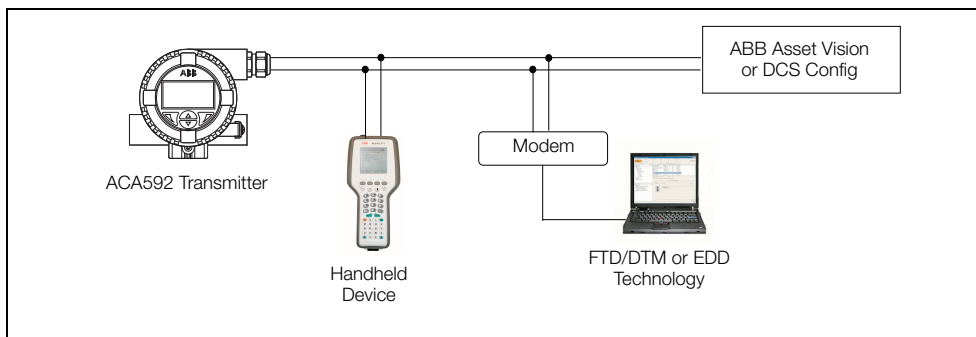

Fig. 6.1 Configuration Options – Schematic

6.2 Configuration DIP Switch

Warning. Isolate the transmitter from power supplies before accessing / setting the DIP switch.

A 6-pin DIP switch located behind the transmitter cartridge is used to enable / protect configuration settings (see Fig. 6.2 below for DIP switch positions). Transmitters are shipped with configuration changes enabled (DIP switch 1 set to the *OFF* position). To protect a configuration, set DIP switch 1 to the *ON* position.

Caution. When setting DIP switch 1, take care not to move DIP switch 6.

If DIP switch 6 is in the **ON** position when the transmitter is powered up, the transmitter's configuration is reset to default (factory) settings.

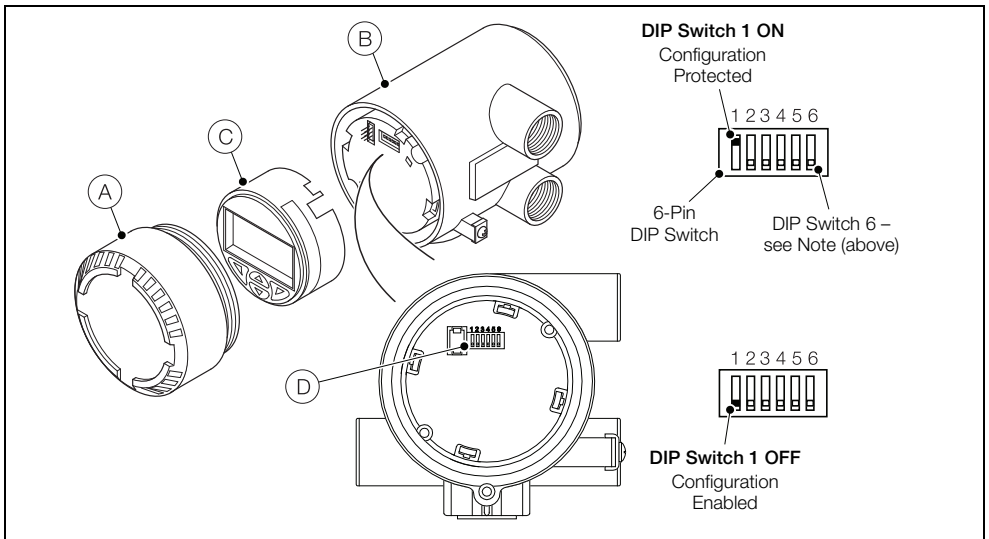

Fig. 6.2 Configuration DIP Switch

To protect a configuration:

1. Unscrew the cartridge cover (A) and remove it from the transmitter (B).
2. Pull the cartridge (C) carefully but firmly out of the transmitter (B) keeping it straight to avoid bending the 6-pin connector (D).
3. At the 6-pin DIP switch (D), set switch 1 to the *ON* position (up).
4. Refit the cartridge (C) by pushing it carefully but firmly into the transmitter. Keep the cartridge (C) straight to avoid bending the 6-pin connector (D).
5. Refit the cartridge cover (A) by screwing it until the O-ring is slightly compressed onto the transmitter (B). For protection in Ex d / explosion-proof installations, turn the 2 security screws (see Fig. 3.1, page 17) until they prevent both covers from being rotated (unscrewed) therefore preventing removal of the covers.

7 Operator Pages and Menus

7.1 Process Display

At power-up (if startup is successful) the startup screen is displayed momentarily after approximately 3 seconds. The display is then blank for the next 6 seconds (while the transmitter performs a self-check). Next the startup screen is displayed again, followed by the *Operator Page*. This is the normal operating state of the transmitter.

Access to the *Operator Menu* and the main menus (used for additional monitoring and configuration) is via an *Operator Page* – see Fig. 7.1. *Operator Page 1* displays information in a single line, *Operator Pages 2* to *4* display information in multi-line formats – see Section 7.1.1, page 47.

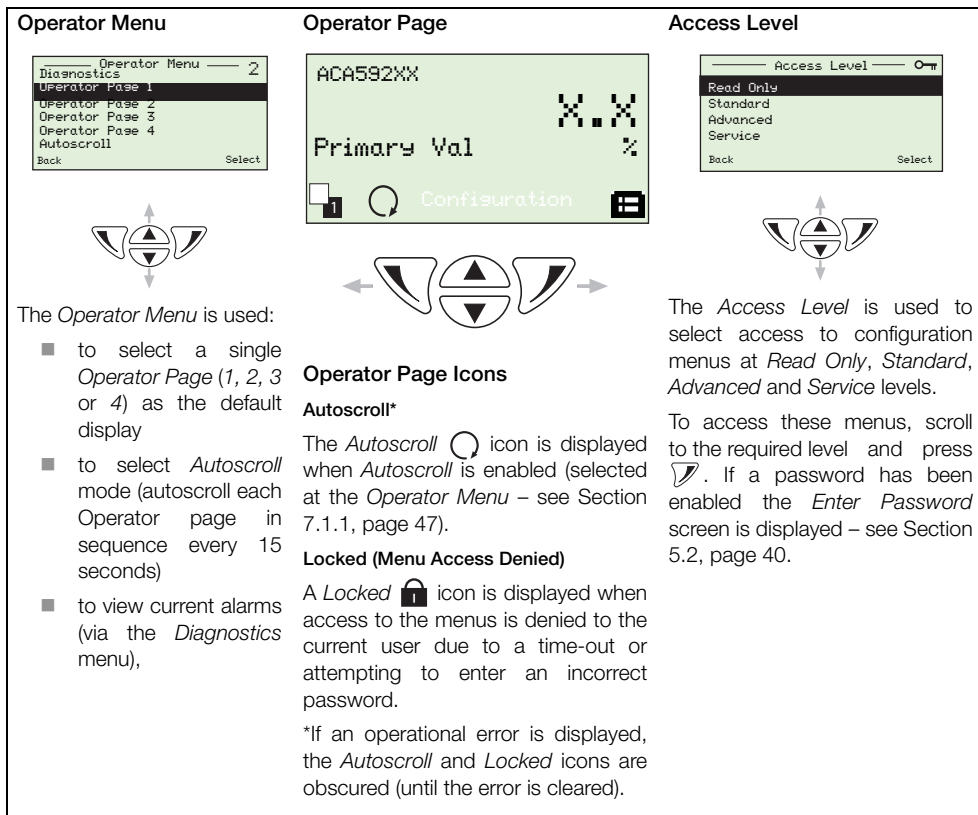
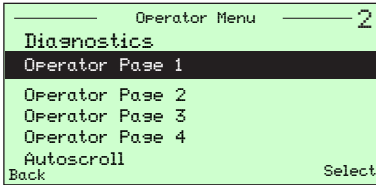

Fig. 7.1 Screen Navigation

7.1.1 Operator Pages



The *Operator Pages* are accessed from the *Operator Menu* by using the and to scroll to the required page and pressing the key.

Four *Operator* pages are available to monitor operation. These can be configured to display live measured input and output values.

An example of an *Operator Page* is shown in Fig. 7.2.

An overview of operator menus (including *Operator Pages*) is shown in Table 7.1, page 48.

Notes.

- It is not possible to configure the system or to modify data within the *Operator Pages*.
- The *Operator Page* number is displayed on each page.

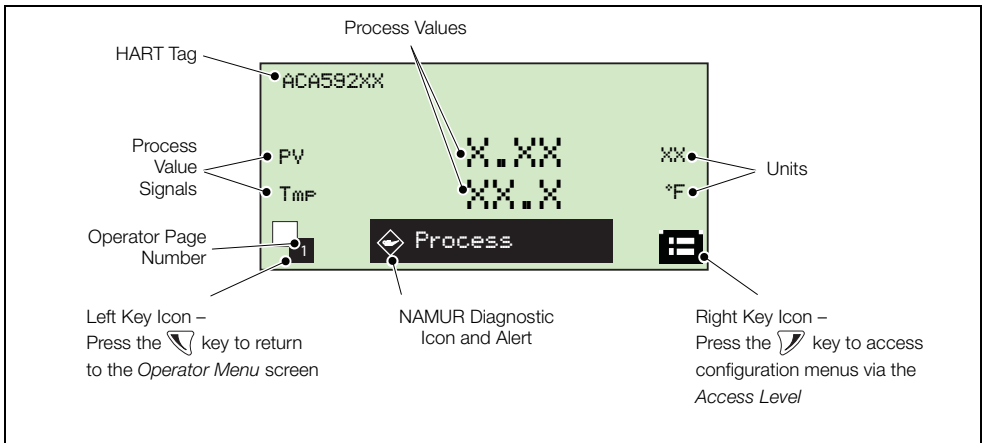

Fig. 7.2 Operator Page Example



Display Example	Title and Function
	<p>Diagnostics</p> <p><i>Diagnostic</i> screen – used to display active diagnostic system data (NAMUR icon, diagnostic code and diagnostic message).</p> <p>Use the ▲ and ▼ keys to scroll through all active diagnostics. Diagnostic messages in this screen do not include historical information that is available from the <i>Diagnostics</i> menu – see Section 7.3.6, page 60.</p> <p>Refer to Section 8.1, page 64 for a list of diagnostic messages.</p>
	<p>Operator Page 1</p> <p>Large primary value on the first line.</p>
	<p>Operator Page 2</p> <p>Large primary value on the first line and a primary value percentage range bar graph.</p>
	<p>Operator Page 3</p> <p>Primary value (plus associated unit) on the first line and a temperature value (and associated unit) on the second line.</p> <p>Data displayed on the second line is set via the <i>Display</i> menu – see Section 7.3.5, page 59.</p>

Table 7.1 Overview of Operator Menus

Display Example	Title and Function
 <p>ACA592XX PV X.XX XX TmpF 77.0 °F XX XX.X mA</p> <p>4 Process</p>	<p>Operator Page 4</p> <p>Primary value (plus associated unit) on the first line, a temperature value (plus associated unit) on the second line and the calculated current output value (and associated unit) on the third line.</p> <p>Data displayed on the second and third lines is set via the <i>Display</i> menu – see Section 7.3.5, page 59.</p>
 <p>Operator Menu — 2</p> <p>Diagnostics Operator Page 1 Operator Page 2 Operator Page 3 Operator Page 4 Autoscroll Back Select</p>	<p>Autoscroll</p> <p>By selecting <i>Autoscroll</i>, each <i>Operator Page</i> is displayed in sequence for 15 seconds. Auto scrolling can be stopped by selecting one of the <i>Operator Pages</i> from the <i>Operator Menu</i>.</p>
 <p>Signals View</p> <p>PV 0.00 % Cnd 1.4 µS/cm UnC 1.5 µS/cm</p> <p>Back Exit</p>	<p>Signals View</p> <p>Displays a list of active signals. Use the ▲ and ▼ keys to scroll through active signals.</p>

Table 7.1 Overview of Operator Menus (Continued)

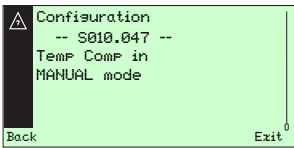
7.2 Parameter Maps

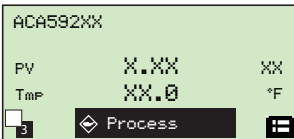
7.2.1 ACA592 2-Electrode Conductivity Transmitter – Conductivity Parameter Map

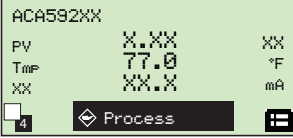
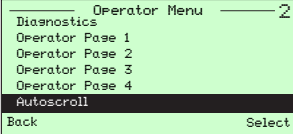
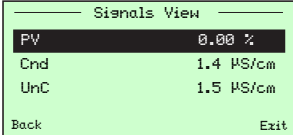
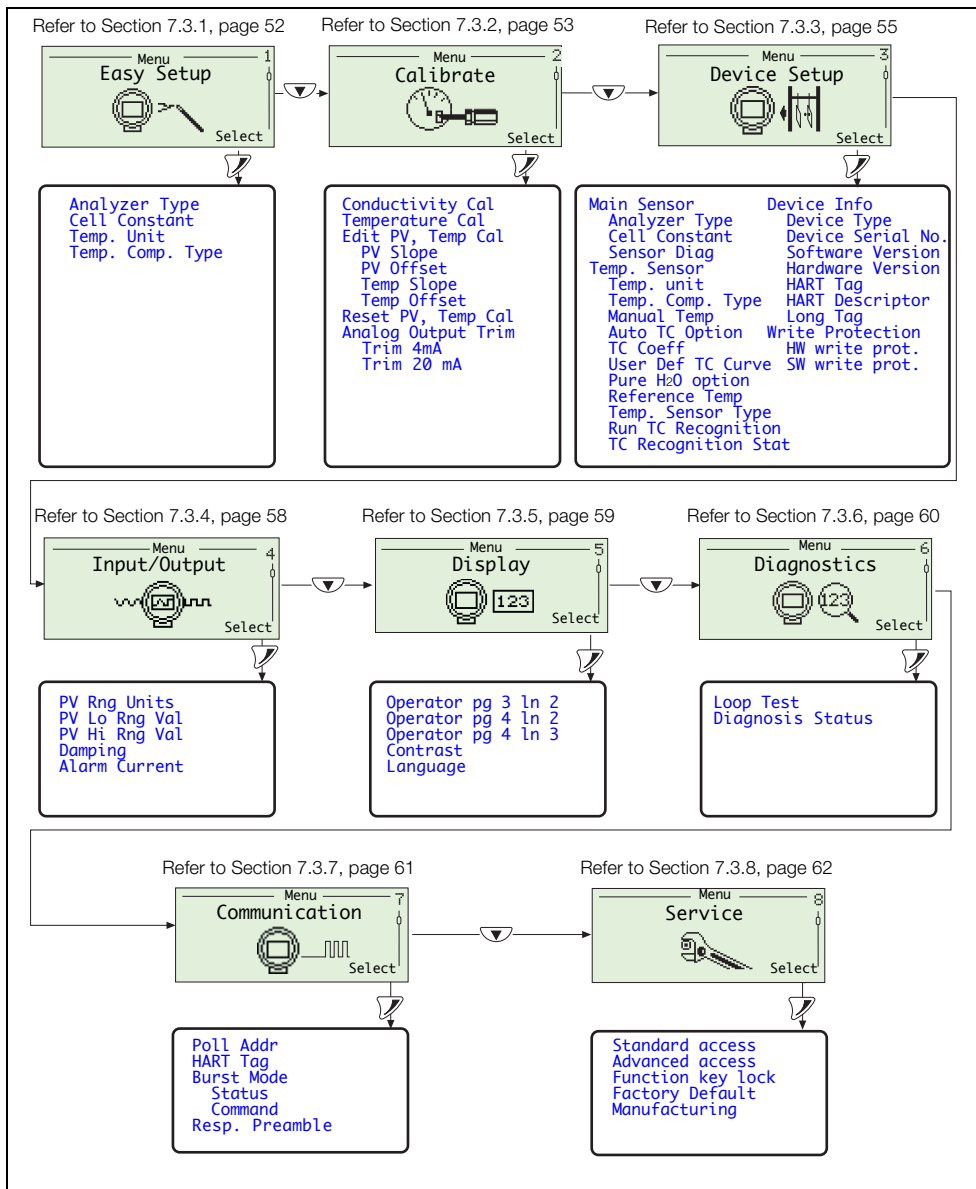

Fig. 7.3 ACA592 2-Electrode Conductivity Transmitter – Conductivity Parameter Map

7.2.2 ACA592 2-Electrode Conductivity Transmitter – Concentration Parameter Map

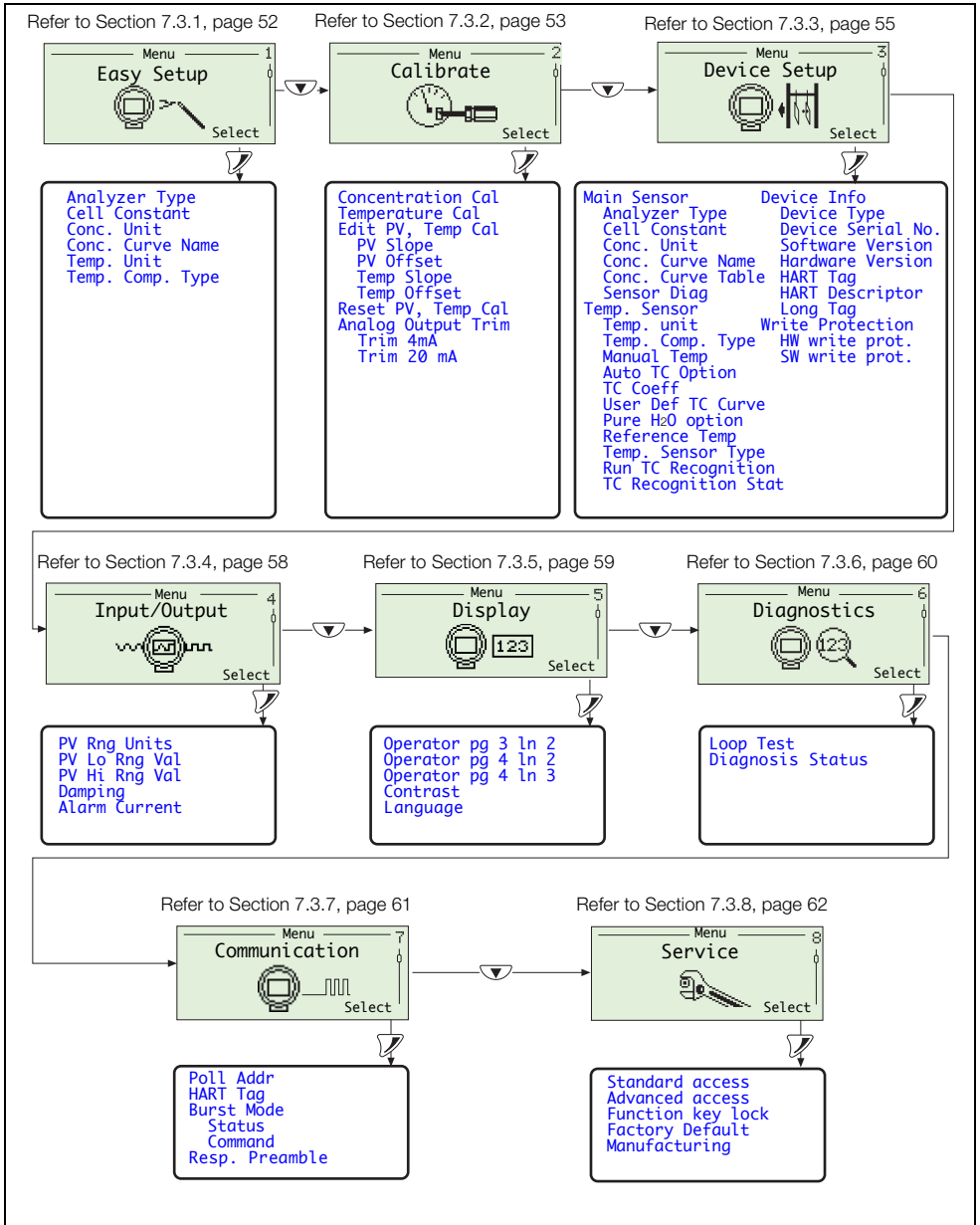
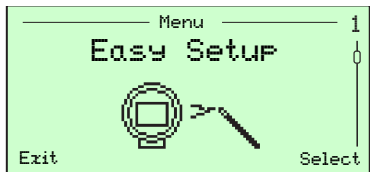

Fig. 7.4 ACA592 2-Electrode Conductivity Transmitter – Concentration Parameter Map

7.3 ACA592 2-Electrode Conductivity Transmitter Parameters

7.3.1 Easy Setup



Users with *Advanced* level access have read and write privileges to the parameters listed.

Users with *Standard* and *Read Only* access have read-only privileges to parameters at *Easy Setup* level.

Easy Setup Level	
Parameter	Description
Analyzer Type	Selects the measurement type: <ul style="list-style-type: none"> ■ Conductivity ■ Concentration
Cell Constant	Adjusts the slope of the calculation graph. The design of the conductivity cell determines the sensor constant (usually $k = 1$). (Range 0.003 to 1.999)
Conc. Unit	Enabled if <i>Analyzer Type = Concentration</i> . Selects the concentration unit: %, ppm, $\mu\text{g/l}$, ppb, mg/l, none
Conc. Curve Name	A user-defined name, enabled if <i>Analyzer Type = Concentration</i> . Press the  key to enter the required characters for the name as detailed on page 40.
Temp. unit	(Temperature Units) Sets the temperature unit ($^{\circ}\text{C}$ or $^{\circ}\text{F}$) applied to all transmitter temperature parameters and values.
Temp. Comp. Type	(Temperature Compensation Type)
Manual	<i>Manual</i> temperature compensation is enabled when the device does not detect any temperature sensor connection either at power-up or upon execution of <i>Run TC Recognition</i> . When <i>Temp Comp Type</i> is <i>Manual</i> , the user configurable <i>Manual Temp</i> value is used for temperature compensation.
Auto	Enabled when a temperature sensor is detected by the device either at power-up or when executing the <i>Run TC Recognition</i> routine (see page 57).

7.3.2 Calibrate

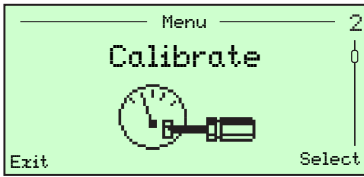

Used to calibrate the sensor and transmitter.

Calibrate Level	
Parameter	Description
Conductivity Cal	<p>Enabled if <i>Analyzer Type = Conductivity</i>.</p> <p>The 2-electrode mode does not require wet calibration if the sensor constant has been input correctly and the sensor cable resistance is not significant.</p> <p>A reference procedure for calibration of a conductivity process value.</p>
Concentration Cal	<p>Enabled if <i>Analyzer Type = Concentration</i>.</p> <p>Used to convert conductivity values to concentration units (from a temperature-compensated measurement).</p> <p>A reference procedure for calibration of a concentration process value.</p>
Temperature Cal	<p>The temperature calibration is used to calibrate the temperature input from the sensor against a standard known reading – see Table 7.2, page 54.</p> <p>A 2-point temperature calibration is performed using this routine by calibrating, in succession, at a low temperature value and a high temperature value (the two values separated by at least 20 °C [68 °F]).</p> <p>This results in both temperature slope and offset computation.</p>
Edit PV, Temp Cal	<p>Enables manual adjustment of the sensor PV slope and offset and sensor temperature slope and offset.</p> <p>Note. This function may not be suitable for many applications, but it provides quick, easy access to these calibration values for troubleshooting.</p> <p>PV Slope Edits the <i>PV Slope</i> value as a percentage</p> <p>PV Offset Edits the <i>PV Offset</i> value</p> <p>Temp Slope Edits the <i>Temp Slope</i> value as a percentage</p> <p>Temp Offset Edits the <i>Temp Slope</i> value</p>
Reset PV, Temp Cal	<p>Resets all process sensor and temperature sensor calibration data to default factory settings.</p>
Analogue Output Trim	<p>Adjusts the maximum / minimum output signals (4 to 20 mA, ±0.5 mA) to maintain precise transmission of the process variable to the final monitoring system.</p> <p>The transmitter's output current is factory calibrated; however, the output can be trimmed if required.</p> <p>Note. Enabled when <i>HART Poll Addr = 0</i> – see page 61.</p> <p>Not applicable to HART multidrop mode where current output is not used.</p>

Temperature Calibration







Step	Procedure	Screen
①	At the <i>Temperature Cal</i> parameter, wait for the message ' <i>Continue When Stable</i> ' to be displayed then press the  key to continue.	 <pre> - Temperature cal -  Temp. 50.0 °C Continue When Stable Abort Continue </pre>
②	Enter the new temperature using the  and  keys to select the new value then press the  key to continue display the result screen.	 <pre> - Temperature cal -  Temp. 50.0 °C New █025.0 Next Continue </pre>

Table 7.2 Temperature Calibration

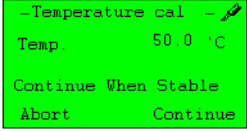
7.3.3 Device Setup

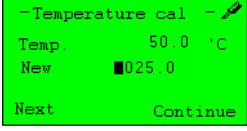

Used to set the sensor / sensor input, run temperature sensor / sensor recognition and obtain transmitter information.

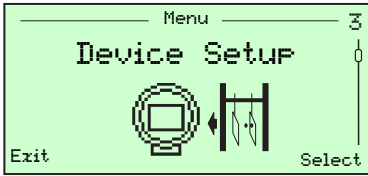
Note. Required level of access = *Advanced*.

Device Setup Level	
Parameter	Description
Main Sensor	
Analyzer Type	Sets the analyzer to a measurement type: <ul style="list-style-type: none"> ■ Conductivity ■ Concentration
Cell Constant	Used to adjust the slope of the calculation graph. The design of the conductivity sensor determines the sensor constant (usually $k = 1$). Range 0.003 to 1.999.
Conc. Unit.	Enabled if <i>Analyzer Type = Concentration</i> . Selects the concentration unit: %, ppm, $\mu\text{g/l}$, ppb, mg/l or none
Conc. Curve Name	A user-defined name, enabled if <i>Analyzer Type = Concentration</i> . Press the  key to enter the required characters for the name as detailed on page 40.
Conc. Curve Table	Enabled if <i>Analyzer Type = Concentration</i> . Enables entry of 6-point conductivity / concentration curve for user-defined concentration calculation. Range = X1 to X6 conductivity in $\mu\text{S/cm}$, Y1 to Y6 concentration
Sensor Diag	Turns sensor diagnostics on (<i>Yes</i>) or off (<i>No</i>) to confirm if a sensor is detected by the transmitter. Default = <i>Yes</i> . Refer to Section 8.1, page 64 for a list of diagnostic messages and suggested resolutions.

Device Setup Level	
Parameter	Description
Temp. Sensor	Temperature sensor parameters.
Temp. unit	Sets the temperature unit (°C or °F) applied to all transmitter temperature parameters and values.
Temp. Comp. Type	Temperature compensation type. <ul style="list-style-type: none"> ■ <i>Manual</i> <i>Manual</i> temperature compensation is enabled when the device does not detect any temperature sensor connection either at power-up or upon execution of <i>Run TC Recognition</i>. When <i>Temp Comp Type</i> is <i>Manual</i>, the user configurable <i>Manual Temp</i> value is used for temperature compensation. ■ <i>Auto</i> Enabled when a temperature sensor is detected by the device either at power-up or when executing the <i>Run TC Recognition</i> routine (see page 57).
Manual Temp	Enabled when <i>Temp Comp Type</i> = <i>Manual</i> . The value in this parameter is used for temperature compensation during <i>Manual</i> temperature compensation mode. Adjustable range -20 to 150 °C (-4 to 302 °F). Default = 25 °C (77 °F).
Auto TC Option	Enabled when <i>Temp. Comp Type</i> = <i>Auto</i> (temperature sensor input is detected). Options comprise: <ul style="list-style-type: none"> ■ <i>Standard KCl</i> ■ <i>TC Coeff</i> ■ <i>User Def.</i> ■ <i>Pure H₂O</i>
TC Coeff	Enabled when a temperature sensor is detected and <i>Auto TC Option</i> = <i>TC Coeff</i> .
User Def. TC Curve	Enabled when a temperature sensor is detected and <i>Auto TC Option</i> = <i>User Def. TC</i> . Enables entry of user-defined temperature compensation curve. Range = Temp 1 to Temp 6, K1/Kref to K6/Kref.
Pure H ₂ O option	Enabled when a temperature sensor is detected and <i>Auto TC Option</i> = <i>Pure H₂O</i> . Enables a Pure H ₂ O temperature compensation option to be selected. Options comprise: <ul style="list-style-type: none"> ■ <i>Acid</i> ■ <i>Base</i> ■ <i>Neutral</i>

Device Setup Level	
Parameter	Description
Reference Temp	Sets the required reference temperature.
Temp. Sensor Type	Indicates the type of temperature sensor detected. Options comprise: <ul style="list-style-type: none"> ■ Pt100 ■ Pt1000 ■ Balco 3k
Run TC Recognition	Starts the auto recognition process for the sensor.
TC Recognition Stat	Indicates if the temperature sensor was recognized / not recognized, either during startup or after execution of the <i>Run TC Recognition</i> function, above.
Device Info	
Device Type	The type of transmitter, for example, ACA592-TE (2-electrode, conductivity transmitter) – read-only.
Device Serial No.	The device-specific serial number – read-only.
Software Version	The transmitter's software version number – read-only.
Hardware Version	The transmitter's hardware version number – read-only.
HART Tag	A configurable 8-character HART tag. Default tag is ACA592TE.
HART Descriptor	Use to specify a short HART description for the transmitter (entered from the alphanumeric character set).
Long Tag	Use to specify a longer HART description for the transmitter (entered from the alphanumeric character set, maximum 32 characters).
Write Protection	
	Displays hardware / software write protection status. Note. Configurations can be protected by enabling the configuration DIP-switch – see Section 6.2, page 45.
HW write prot.	Displays the current state of the Hardware Write Protection switch (configuration DIP-switch) – <i>Off / On</i> .
SW write prot.	Turns the software <i>Write Protection Off / On</i> . Note. Software <i>Write Protection</i> cannot be modified when hardware write protection is enabled through the DIP switch – see Section 6.2, page 45.

7.3.4 Input/Output

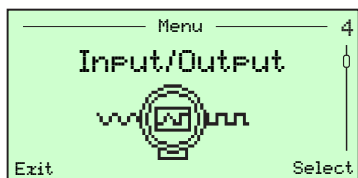



Used to setup process value high / low ranges, damping and alarm current settings.

Input Output Level	
Parameter	Description
PV Rng Units	Enables conductivity units selection for the purpose of editing the PV range values (<i>PV Lo / Hi Rng Val</i>). This is independent of the Process value units. Parameter is read-only when <i>Analyzer Type = Concentration</i> .
PV Lo Rng Val	The PV low (minimum) value 0.0 (corresponding to 4 mA) of selected <i>PV Rng Units</i> .
PV Hi Rng Val	The PV high (maximum) value corresponding to 20 mA of selected <i>PV Rng Units</i> . Maximum values: Cell constant 0.003 – 0.054 200 $\mu\text{S}/\text{cm}$ (or 0.2 mS/cm) Cell constant 0.055 – 0.299 2000 $\mu\text{S}/\text{cm}$ (or 2 mS/cm) Cell constant 0.3 – 0.054 20000 $\mu\text{S}/\text{cm}$ (or 20 mS/cm)
Damping	Enables damping of the 4 to 20 mA response. Minimum value 0.0 s, maximum value 99.9 s.
Alarm Current	Level of current loop output under alarm conditions. Options comprise: <ul style="list-style-type: none"> ■ <i>High</i> (corresponds to alarm current level of 21.5 mA) ■ <i>Low</i> (corresponds to alarm current level of 3.8 mA)

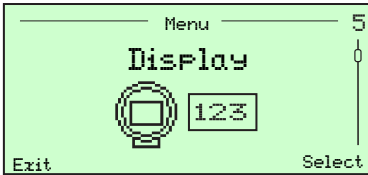
7.3.5 Display



Used to configure and format the information displayed, including: language, data displayed on Operator Pages 3 and 4 and screen contrast.

Display Level	
Parameter	Description
Conductivity units	Selects the conductivity unit displayed on HMI only (this parameter is not displayed on the transmitter). Auto, $\mu\text{S}/\text{cm}$ or mS/cm (this is independent of the conductivity used for HART communication).
Operator pg 3 In 2	Selects the type of data displayed on line 2 of <i>Operator Page 3</i> : Temperature compensated conductivity, temperature uncompensated conductivity, temperature, PV %, current output.
Operator pg 4 In 2	Selects the type of data displayed on line 2 of <i>Operator Page 4</i> : Temperature compensated conductivity, temperature uncompensated conductivity, temperature, PV %, current output.
Operator pg 4 In 3	Selects the type of data displayed on line 3 of <i>Operator Page 4</i> : Temperature compensated conductivity, temperature uncompensated conductivity, temperature, PV %, current output.
Contrast	Displays the current contrast level (default 50 %) and enables the contrast to be changed using the  and  keys.
Language	Selects the display language for all parameters: English, Deutsch, Francais, Espanol, Italiano, Portugues

7.3.6 Diagnostics



Used to perform a loop test (output verification) and indicate the diagnostic status (actual / simulated).

Diagnostics Level	
Parameter	Description
Loop Test	The current output of the transmitter can be adjusted between 3.8 and 21.5 mA. This feature is useful to verify that the transmitter output matches the current in the control room. Enabled when <i>HART Poll Addr = 0</i> – see page 61.
Diagnosis Status	Used to determine if diagnostics simulation is active (read-only parameter). The display should read 'Actual' indicating real-time diagnostics from the transmitter.

7.3.7 Communication

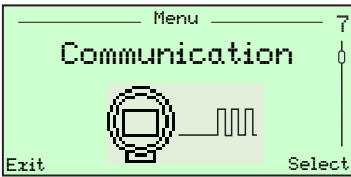





Used to configure HART communication parameters – see Section 9, page 71.

Communication Level	
Parameter	Description
Poll Addr	<p>The <i>Poll Addr.</i> (poll address) is used by a HART communication master to communicate with a HART device.</p> <p><i>Poll Addr.</i> = 0 conforms to HART point-to-point operating mode (4 to 20 mA current output following the Primary Value).</p> <p><i>Poll Addr.</i> = 1 to 15 conforms to HART multidrop operating mode, where more than one HART device can coexist on the same set of communication lines.</p> <p>The current output is fixed at 4.0 mA and does not follow the Primary Value.</p> <p>Note. Changing the <i>Poll Addr.</i> while the transmitter is communicating with a HART master causes loss of HART communication.</p>
HART Tag	A configurable 8-character HART tag used for identification.
Burst Mode	<p><i>Burst Mode</i> is a HART feature used to transmit one of three Universal HART command response packages on the HART bus continuously, without the need for commands being sent by the Master.</p> <p>This can be used to provide the quickest possible output from the transmitter.</p>
Status	Enables / disables <i>Burst Mode</i> (On / Off).
Command	Selects the HART command for which the response package will be transmitted continuously from the transmitter when Burst mode is turned on, refer to Section 9, page 71 for details of available commands.
Resp. Preamble	<p>The <i>Resp. Preamble</i> (response preamble) parameter determines the number of communication preamble bytes sent in the response message from the transmitter.</p> <p>The Response preamble can be set for any value from 5 to 20 bytes (default value 5 bytes).</p> <p>Note. This value must be synchronized with the control system.</p>

7.3.8 Service



Service level parameters are read-only and reserved for ABB factory-trained personnel.

Service Level	
Parameter	Description
Standard access	Enables / disables password protection to the <i>Standard Access</i> level. The factory default is disabled (<i>Disable password</i>).
Advanced access	Enables / disables password protection to the <i>Advanced Access</i> level. The factory default is disabled (<i>Disable password</i>).
Function key lock	Locks the   ,  ,  keys on the keypad. Factory default is unlocked (<i>No</i>). To lock the keypad select <i>Yes</i> . To unlock the keypad, first enable the keypad by holding down the  key for 5 seconds, then access the <i>Function key lock</i> menu and select <i>No</i> .
Factory Default	Resets all parameters to their factory default settings.
Manufacturing	This parameter is reserved for factory access only.

8 Troubleshooting and Diagnostics

During operation, the transmitter performs continuous diagnostic checks on hardware, software and sensor functions. If a non-conformance condition is detected the an alert is displayed in the lower portion of the *Operator* screen. Press the  key to access the *Operator Menu* and select the *Diagnostics* screen to view the messages – see Fig. 8.1 for an example of a message.

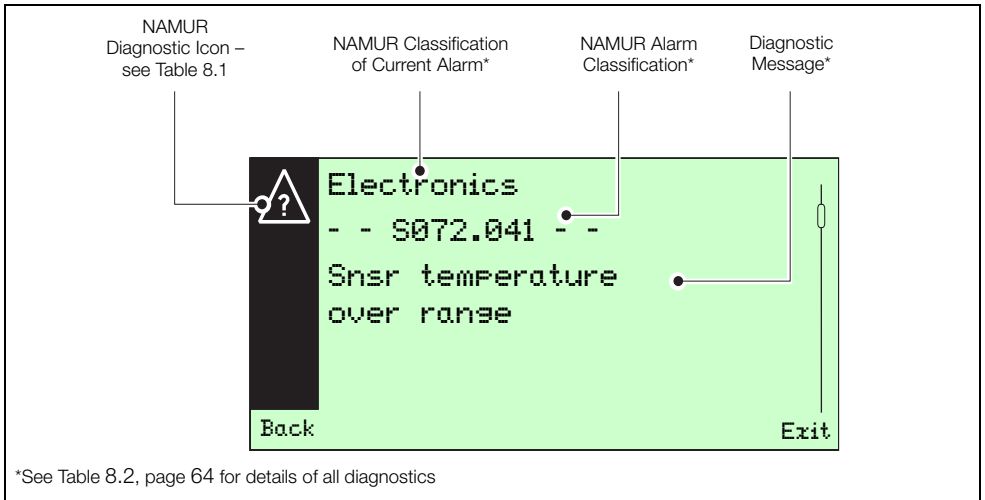

Fig. 8.1 Example of Diagnostic Alert

NAMUR (NE107)-based icons are used to indicate diagnostic conditions. The severity of the condition is related to the icon type displayed with the message – see Table 8.1 (see Section 8.1, page 64 for a list of messages and corrective actions).





Icon and Name	Description
 Failure	Transmitter functionality lost due to malfunction in the Instrument itself, its peripherals or due to operating conditions.
 Maintenance Required	Transmitter functionality fully available but maintenance required soon to avoid functional restrictions.
 Check Function	Transmitter functionality might be temporarily restricted due to on-going work. Example – simulation or a function check.
 Out of Specification	Transmitter functionality available but decreased due to operating conditions outside the specified limits or due to internal problems.

Table 8.1 NAMUR Diagnostic Icons

8.1 Diagnostic Messages

Diagnostic messages are related to 5 conditions:

1. Process diagnostics – the process setup or sensor connected to the ACA592–XX transmitter.
2. Sensor diagnostics – the sensor, its connections or calibration.
3. Installation diagnostics – HART setup, or, more commonly, during initial installation of the transmitter or a new sensor.
4. Operating conditions diagnostics – the operating condition of the transmitter, such as the DC voltage used to power the transmitter.
5. Electronics diagnostics – the transmitter's internal circuitry or the wiring connected to it.

Note.

- Sub-error messages are displayed on the transmitter DTM software only.
- Some diagnostic messages can be masked (see Section 8.2, page 68). This function is indicated in column 1 of Table 8.2 (below) where available.

Table 8.2 (below) lists diagnostic messages in alphabetical order:



Diagnostic Message [Sub-error Message]	Possible Cause(s) [Related Condition]	Corrective Action
Configuration Changed 	The device configuration has been changed by a write or set command or by an operation via device HMI. [INSTALLATION: This condition is not displayed on the HMI. This is just an indication to the HART master. It is visible only on the EDD and DTM]	Ensure that the copy of the device configuration in the DTM is the same as the device, (perform a configuration upload or download as required), then clear the <i>Configuration Changed</i> flag from the <i>Extras / Reset</i> menu.
C090.030 Output hold is enabled (Loop Test) 	The analog and digital analog outputs for the Primary Variable are held at the requested value. Device is in fixed current <i>Output hold is enabled (Loop Test)</i> mode – see Section 7.3.6, page 60. [STATUS]	Use a HART configurator (DTM / hand held) to place device back into normal operating mode (remove from <i>Loop Test</i> – Fixed output mode).
M085.037 Sensor Secondary PV input error 	Secondary PV signal related sensor board electronics malfunction [ELECTRONICS]	Check sensor connections. If the error persists, contact factory. (Maskable message)

Table 8.2 Diagnostic Messages







Diagnostic Message [Sub-error Message]	Possible Cause(s) [Related Condition]	Corrective Action
F086.000 PV input error 	PV related sensor board electronics malfunction. [ELECTRONICS]	Contact factory.
F088.016 Sensor electronics failure or wrong sensor board [Sensor electronics interface error] 	Data exchange with sensor electronics board has failed. [ELECTRONICS]	Power cycle the device and check if the problem is corrected. If the error persists, replace electronics.
F106.032 Unreliable output current 	The D to A converter is not properly Calibrated / Trimmed or output current has reached its hardware limit. [ELECTRONICS]	Perform an Output Trimming. If the error persists, replace the electronics. Check the device configuration.
F108.035 Output ReadBack failure 	The output circuit could be broken or not correctly calibrated [ELECTRONICS]	Perform an Output Trimming routine. If the error persists replace electronics.
F116.023 Memory Failure 	Electronic memory corrupted. [ELECTRONICS]	Replace electronics. Contact factory.
M023.036 Sensor electronics voltage warning 	Sensor electronics related malfunction. [ELECTRONICS]	Check sensor wiring. If problem persists, contact factory. (Maskable message)

Table 8.2 Diagnostic Messages (Continued)







Diagnostic Message [Sub-error Message]	Possible Cause(s) [Related Condition]	Corrective Action
M024.033 Power Supply warning [Power Supply too High / Power too Low] 	The Device Power Supply is close to the highest / lowest acceptable limit. [Operating / DC Power Supply]	Check the voltage at the terminal block and if it is not within the valid range check the external power supply. (Maskable message)
M026.024 Non-volatile memory burn error 	Writing to the electronic non-Volatile Memory was not successful. [ELECTRONICS]	Replace the electronics as soon as possible. (Maskable message)
M058.018 Snsr factory cal data corrupt 	Sensor factory calibration data corrupt or missing. [ELECTRONICS]	Contact factory. (Maskable message)
M098.031 Analog output saturated [Analog output high saturated] [Analog output low saturated] 	The analog output for the Primary Variable is beyond its high / low scaling limit and no longer represents the true applied process. The Analog Output (4 to 20 mA) is saturated to the configured Saturation Limit High / Low. [PROCESS]	Adjust the working range if possible.
S010.041 Temp comp in MANUAL mode 	The device is in Manual TC mode and not measuring process temperature. [STATUS]	If a temperature sensor is connected, activate a <i>Run TC Recognition</i> . If recognition fails, check the temp sensor wiring. Ignore or mask this warning if <i>Manual TC</i> is required. (Maskable message)
S070.040 Sensor temperature under range 	Sensor temperature is below range. [PROCESS]	Verify sensor wiring. Verify configuration related to temperature sensor and temperature compensation. (Maskable message)

Table 8.2 Diagnostic Messages (Continued)





Diagnostic Message [Sub-error Message]	Possible Cause(s) [Related Condition]	Corrective Action
S072.039 Snsr temperature over range 	Sensor temperature is above range. [PROCESS]	Verify sensor wiring. Verify configuration related to temperature sensor and temperature compensation. (Maskable message)
S074.001 Temperature input error 	Temperature related sensor board electronics error. [PROCESS]	Check temperature sensor connections. If a temperature sensor is not connected, switch temperature compensation to <i>Manual</i> mode. If the problem persists, contact factory. (Maskable message)
S076.010 PV out of range limits 	The analog output for the Primary Variable is beyond its scaling limit and no longer represents the true applied process. [PROCESS]	Adjust the working range if possible. (Maskable message)
S078.004 PV out of physical limit 	The process applied to the sensor for the Primary Variable is beyond the operating limits of the device. [PROCESS]	Verify sensor wiring. Verify configuration setting for the sensor. (Maskable message)
S084 038 Sensor polarization detected 	Invalid process conditions, improper sensor wiring, or trapped air in sensor cavity. [SENSOR]	Verify process conditions, specifically conductivity levels, are within values identified in the Specifications. Verify sensor does not have trapped air bubbles within the sensing cavity. Verify sensor wiring is properly connected, not shorted to other wiring or metal surfaces, free of nicks, cuts, breaks and/or open connections. Verify terminal blocks and other connections are free of liquids, oils, scale or corrosion and sensor tip is clean. If a sensor extension cable is used, verify ABB approved cabling is used and the connections are dry and free of corrosion. Verify sensor responds to conductivity standard solutions. Verify configuration.

Table 8.2 Diagnostic Messages (Continued)

8.2 Diagnosis Screens

Diagnosis screens can be viewed using the DTM or the EDD graphical user interface (they cannot be viewed on the transmitter's display).

8.2.1 ACA592 2-Electrode Conductivity Transmitter – Diagnosis Overview Screen

An overview of active / inactive diagnostic conditions can be viewed on the diagnosis *Overview* screen – see Fig. 8.2.

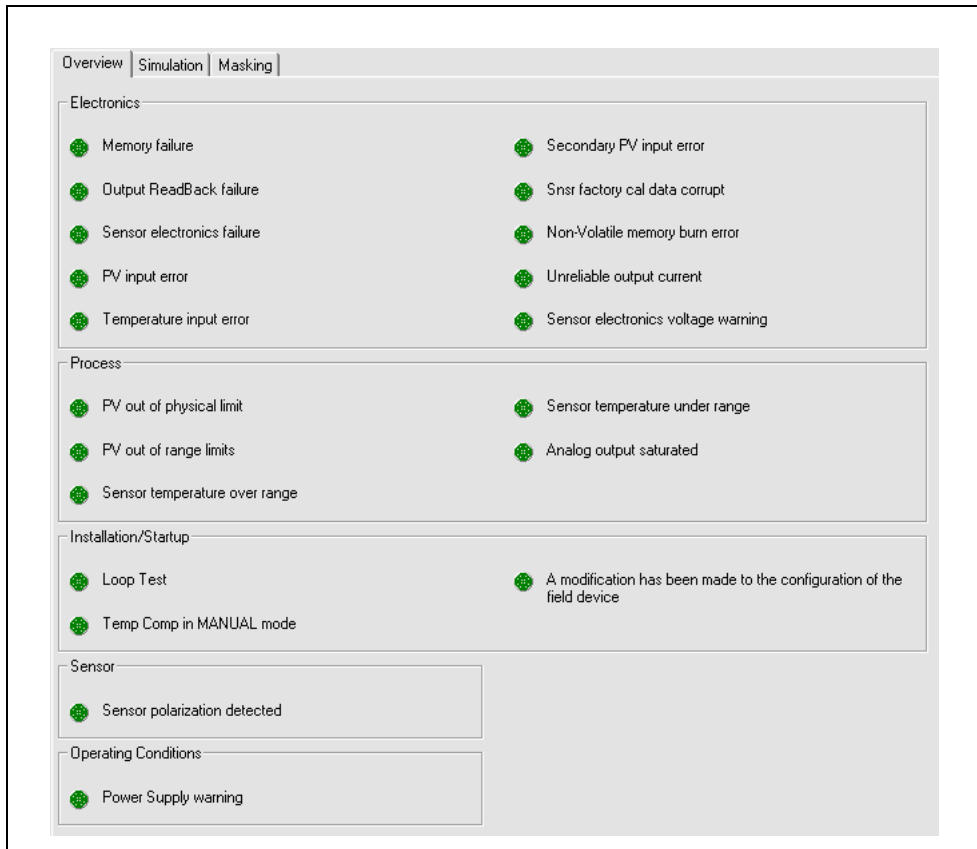

Fig. 8.2 ACA592 2-Electrode Conductivity Transmitter – Diagnosis Overview Screen

8.2.2 ACA592 2-Electrode Conductivity Transmitter – Diagnosis Masking

Certain non-critical diagnoses can be masked using the DTM or the EDD. This feature is not accessible via the transmitter's display and a masked diagnosis is not reported when it occurs. The list of maskable diagnoses is available on the DTM and EDD graphical user interface only.

The diagnosis *Masking* screen is shown in Fig. 8.3.

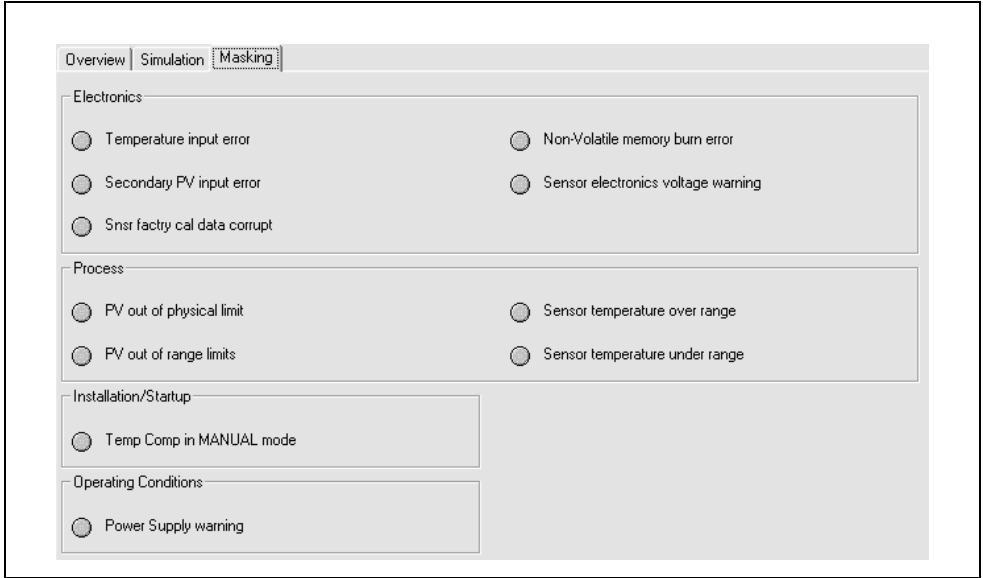

Fig. 8.3 ACA592 2-Electrode Conductivity Transmitter – Diagnosis Masking Screen

8.2.3 ACA592 2-Electrode Conductivity Transmitter – Diagnosis Simulation

All diagnosis conditions except *Loop test* (see page 64) can be simulated individually using the DTM or EDD.

To simulate a diagnosis, turn the diagnosis simulation ON, select a diagnosis and send it to the transmitter. In *Simulated Diagnosis* mode, all active diagnoses are suppressed and only the simulated diagnosis is reported.

Diagnosis simulation status can be viewed on the HMI using *Diagnostics / Diagnosis status* menu (see Section 7.3.6, page 60). The status is either *Simulated* or *Actual* (diagnosis simulation cannot be set or cleared from the HMI).

Caution.

- Diagnosis simulation cannot be performed via the transmitter's display.
- Diagnosis simulation should be used for advanced test purposes only.
- Diagnosis simulation is volatile – simulation setting is lost after a power-up.

The diagnosis *Simulation* screen is shown in Fig. 8.4.

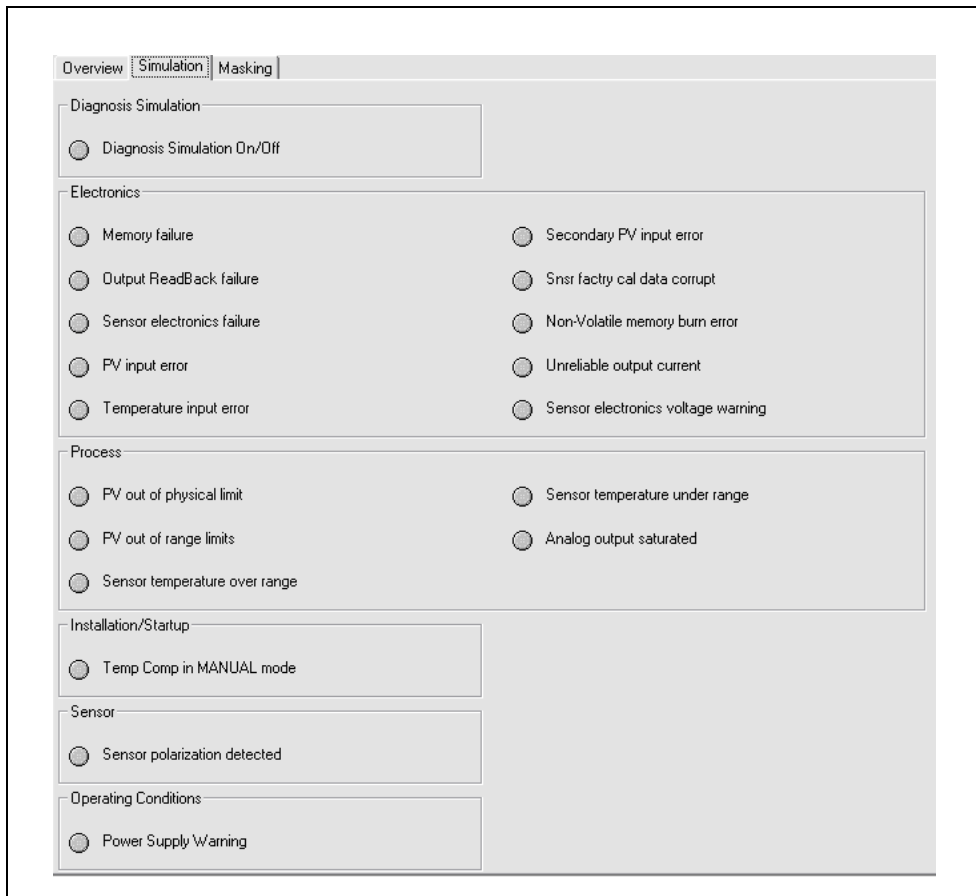

Fig. 8.4 ACA592 2-Electrode Conductivity Transmitter – Diagnosis Simulation Screen

9 HART Communication

For ease of identification, each HART device features a configurable 8-character HART tag. In addition to the HART tag, each device has a HART address (set to the default value 0). At this address the device operates in HART standard communication mode (point-to-point operation).

When an address in the range 1 to 15 is used, the transmitter switches to HART multidrop mode. This operating mode enables users to connect up to 15 transmitters in parallel to a power supply.

In multidrop mode, an analog output signal that matches the Primary Value is not available. The output signal in multidrop mode is, basically, a constant 4 mA and is used exclusively for the power supply.

In multidrop mode, sensor or process data information is available as a HART signal only.

In addition to point-to-point and multidrop modes, the third type of HART communication is burst mode. When *Burst Mode* is activated, the transmitter transmits a HART telegram containing process information continuously, (approximately every 500 ms) without prompting by a HART command.

Refer to the *Communication* level (see page 71) for further details of the *Burst Mode*.

9.1 HART Device Type Codes

All HART products contain unique identifiers that specify the device type.

The device type code for ACA592-TE 2-electrode conductivity transmitter series is: 50 (32 hex).

9.2 HART Configuration Maps

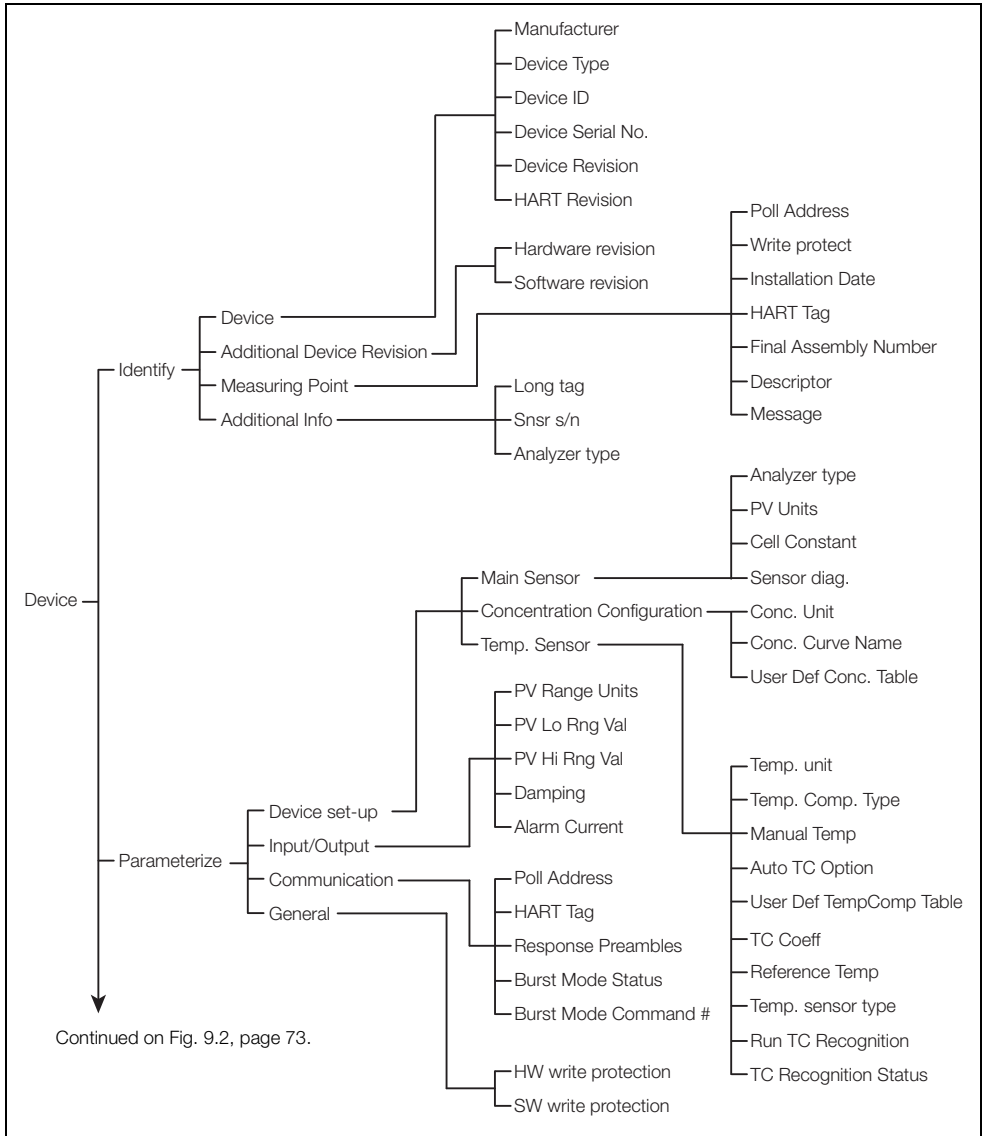

Fig. 9.1 ACA592 2-Electrode Conductivity Transmitter – HART Configuration Parameters

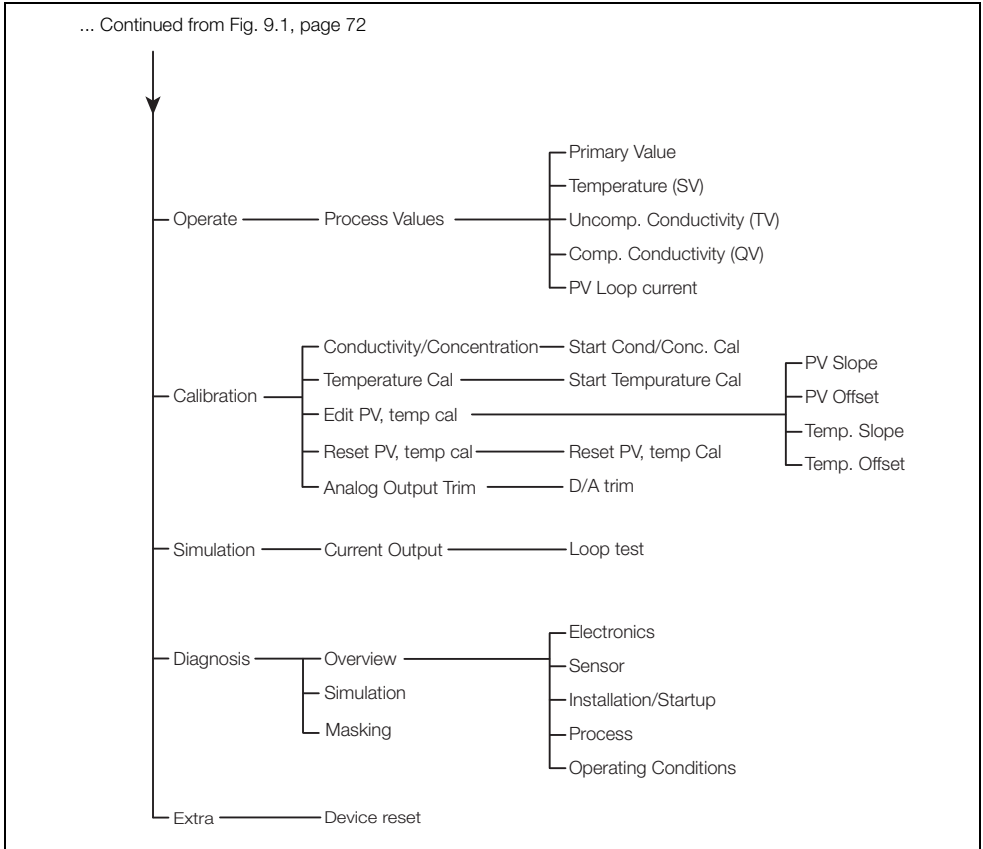

Fig. 9.2 ACA592 2-Electrode Conductivity Transmitter – HART Configuration Parameters (continued)

9.3 HART Universal Commands

Command No.	Description	Details
0	Read Transmitter Unique Identifier	Expanded device type code. Manufacturer identification code. Manufacturer device type code. Number of preambles. Revision level of HART Universal Command set implemented. Revision level of device-specific command set implemented. Transmitter software revision level. Transmitter hardware revision level. Device identification number.
1	Read Primary Variable	Process value with units.
2	Read Current and % of Range	Reads the Primary Variable as Current and a percent of the Primary Variable Range. The Primary Variable Current always matches the Analog Output current of the device including alarm conditions and set values. Percent of Range always follows the Primary Variable, even if the Primary Variable Current is in an alarm condition or set to a value. Also, the Percent of Range is not limited to values between 0 % and 100 %, but instead tracks the Primary Variable beyond the Range Values to the Sensor Limits when they are defined.
3	Read Dynamic Variables and Current	Read the Primary Variable Current and up to four predefined Dynamic Variables. The Primary Variable Current always matches the Analog Output current of the device including alarm conditions and set values. The Secondary, Tertiary, and 4th Variables are defined by each device type. <ul style="list-style-type: none"> ■ Secondary variable –temperature ■ Tertiary Variable – temperature uncompensated conductivity in $\mu\text{S}/\text{cm}$ ■ 4th variable – temperature compensated conductivity in $\mu\text{S}/\text{cm}$

Table 9.1 HART Universal Commands

Command No.	Description	Details
6	Write Polling Address	When set to 0 Current Output is active and provides an analog output proportional to the Primary Value. HART operates in point-to-point mode. When set between 1 to 15, Current Output is fixed at 4 mA and HART operates in multi-drop mode.
11	Read unique Identifier Associated with Tag	Returns the expanded device type code, revision levels and identification number of the device that contains the HART identification tag sent with this command.
12	Read message	Returns the user-defined HART message.
13	Read Tag, Descriptor and Date	Returns the user-defined HART information: HART Tag HART Descriptor Device installation date
14	Read Primary Variable Sensor Information	Returns the sensor limits and minimum permissible span of the sensor.
15	Read Primary Variable Output Information	PV Alarm selection code: 0 = Low, 1 = High, PV upper and lower range values. Damping time. Write protection status. Any private label distributor code associated with the device.
16	Read Final Assembly Number	Returns the user-defined final assembly number.
17	Write Message	Enables a user-defined message of up to 32 characters to be entered.
18	Write Tag, Descriptor and Date	Enables the user to assign a user-defined 8-character tag to the device. Enables a user-defined 16-character descriptor to be entered. Enables an installation date to be entered.
19	Write Final Assembly Number	Enables a user-defined final assembly number to be entered. This can be used for inventory or maintenance purposes.

Table 9.1 HART Universal Commands (Continued)

9.4 HART Common Practice Commands

Command No.	Description	Details
34	Write Damping	Enables the user to alter the PV damping value in seconds
35	Write the PV Range	Enables the low and high range values to be set for the range.
38	Write Configuration Reset	Enables the configuration changed flag to be changed.
40	Write Fixed Output Value	A value in the range of 3.8 to 21.5 can be written to fix the output of the device. A value of 0.0 should be written to fixed Output Value to exit the device from fixed output mode.
41	Start Self Test	Performs self-test function on the device.
42	Master Reset	Device can be reset.
44	Write PV Units	Select the units in which the Primary Variable and Primary Variable Range will be returned. This will also select the units for Primary Variable Sensor Limits and Primary Variable Minimum Span.
45	Write Trim Loop Current Zero	Enables user to trim the lower endpoint (for example, ~4.0mA) of the device's output.
46	Write Trim Loop Current Gain	Enables user to trim the upper endpoint (for example, ~20.0 mA) of the device's output.
47	Write PV Transfer function	User can alter the PV output linearity (used if a function-generator is needed for output adjustment)

Table 9.2 HART Common Practice Commands

Command No.	Description	Details
48	Read Device Status	The status of the device, determined from results of the continuous self-diagnostics, is reported every time communications with the device are established. If the device indicates there is additional status information, it can be obtained via this command.
49	Write Sensor Serial Number	Sensor serial number can be entered.
59	Write Number of Response Preambles	User can access and write the number of Response Preambles
108	Write Burst Mode Command Number	Burst command numbers 1, 2, 3 can be entered.
109	Write Burst Mode Control	User can turn ON/OFF Burst mode with this command.

Table 9.2 HART Common Practice Commands (Continued)

10 Specification

Input

Sensor Types

ACA592-TE ABB 2-electrode sensors

Measurement Range and Resolution

ACA592-TE (2-electrode conductivity transmitter):

Cell Constant	Measurement Range	Resolution / Accuracy / Linearity / Stability
0.01	0 to 200 µS/cm	0.001 µS/cm
0.1	0 to 2000 µS/cm	0.01 µS/cm
1	0 to 20000 µS/cm	0.1 µS/cm

Temperature

Compensation

Temperature Element	ACA592-TE
Pt100	✓
Pt1000	✓
Balco 3k	

Compensation Modes

Measured Liquid

User-defined

Pure H₂O neutral salt

Pure H₂O trace base

Pure H₂O trace acid

Input Range

-20 to 200 °C (-4 to 392 °F)

Accuracy / Stability

±0.1 °C (0.18 °F) after calibration

Dynamic Response

<3 Seconds for 90 % step change at 0.00 second dampening

Output

Signal

Configurable 4 to 20 mA (standard with HART)
User-programmable linear and non-linear across the entire range

Dynamic range 3.9 to 20.75 mA (3.8 mA = low alarm level, 21.5 mA = high alarm level)

Minimum Span

Sensor Type	ACA592-TE
0.01 Sensor	1 µS/cm
0.10 Sensor	10 µS/cm
1.0 Sensor	100 µS/cm

Maximum span

Sensor Type	ACA592-TE
0.01 Sensor	200 µS/cm
0.10 Sensor	2000 µS/cm
1.0 Sensor	20 mS/cm

Damping

Adjustable 0.0 to 99 seconds

Power Supply (Polarity Safe)

Supply Voltage

$U_s = 12$ to 42 V DC (Non-intrinsically safe installations)
 $U_s = 12$ to 30 V DC (Intrinsically Safe and Ex ia installations)

Maximum Permissible Ripple

Maximum ripple for supply voltage during communication in accordance with HART FSK physical layer specification, version 8.1 (08/1999) section 8.1

Under-voltage Protection

$U_{Terminal-Mu} < 12$ V results in $I_a = 3.8$ mA

Maximum Load

$R_{load} = (supply\ voltage - 12\ V) / 22\ mA$
Max. load Ω depending on supply voltage (V DC)

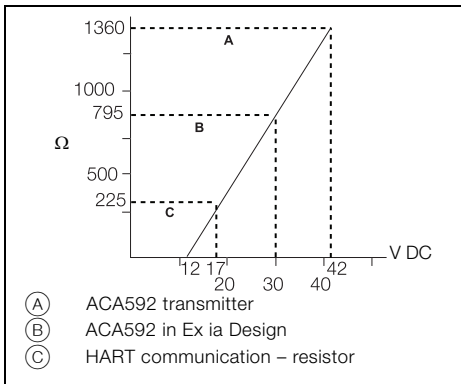

Fig. 10.1 Maximum Load

General Information

Display Update Speed

< 250 milliseconds

Environmental (Temperature)

Operating: -20 to 60 °C (-4 to 140 °F)

Storage: -40 to 80 °C (-40 to 176 °F)

Humidity

< 95 % RH non-condensing

Enclosure Protection

Aluminum, die cast, chromized inside/outside,

70 µm epoxy powdercoat (aluminum, magnesium content < 6 %, copper-free < 0.5 %)

Weight

1.3 Kg (3 lb.)

Cable Gland Protection

IP66 and 67 for plastic glands supplied with general purpose / Intrinsically safe instruments.

IP67 for stainless glands required for Ex d explosion-proof instruments.

EMC and Rf Interference

Emitted electromagnetic interference in accordance with EN61326-1 for Class A and Class B equipment

Galvanic Isolation

900 V DC for 1 second (insulation test voltage)

Equipment Markings

Intrinsic Safety – FM and CSA

- FM Class I, Div. 1, Groups A, B, C, D
Class II/III, Div. 1, Group E, F, G; T4 Ta = 60 °C
- CSA Class I, Div. 1, Groups A, B, C, D
Class II, Div. 1, Groups E, F, G
Class III, Div. 1; T4

Intrinsic Safety – ATEX / IECEx

- Approved for:
- II 1G Ex ia IIC T4
 - II 1D Ex iaD A20 IP66 T135 °C, $-20\text{ °C} \leq T_{amb} \leq 60\text{ °C}$

Intrinsically Safe and Ex ia IIC Hazardous Area

Parameter	Supply Circuit
Maximum voltage	$U_i = 30\text{ V}$
Maximum input current	$I_i = 160\text{ mA}$
Maximum power	$P_i = 0,8\text{ W}$
Internal inductance	$L_i = 0,5\text{ mH}$
Internal capacitance	$C_i = 5\text{ nF}$

Type n (Non-sparking) and Dust – ATEX / IECEx

- Approved for:
- II 3 G Ex nA IIC T4
- Approve for:
- II 3 D Ex tD A22 IP66 T135°C, $-20\text{ °C} \leq T_{amb} \leq 60\text{ °C}$

Non-incendive – FM and CSA

(when installed in accordance with the installation drawing P0909 of Appendix B)

- FM Class I, Div. 2, Groups A, B, C, D
Class II/III, Div. 2, Group F, G; T4 Ta = 60 °C
- CSA Class I, Div. 2, Groups A,B,C,D
Class II, Div. 2, Groups F, G
Class III, Div. 2; T4

Explosion-proof, ignition-proof – FM and CSA

- FM XP, Class I, Div. 1, Groups A,B,C,D
Class II/III, Div. 1, Group E, F, G; T4 Ta = 60 °C
- CSA Class I, Div. 1, Groups A,B,C,D
Class II, Div. 1, Groups E, F, G
Class III, Div. 1; T4

Flameproof and Dust Protection – ATEX / IECEx

- Approved for:
- II 2 G Ex d IIC T4
 - II 2 D Ex tD A21 IP66 T135°C, $-20\text{ °C} \leq T_{amb} \leq 60\text{ °C}$

Agency Enclosure Ratings

- IP66 and IP67
NEMA 4X

Approvals

CE Mark

The ACA592-TE including type B LCD display / configuration software meets all requirements for the CE mark in accordance with the applicable directives 2004/108/EC (EMC), 2006/95/EC (LVD) and 94/9/EC (ATEX).

11 Spares and Accessories





Part Number	Description	Item
4TB9515-0281	LCD display	
4TB9515-0282	Window cover	
4TB9515-0283	Wall / pipe mounting kit	
4TB9515-0285	1/2 in. NPT nylon cable gland (I.S./Non-Incendive)	
4TB9515-0286	1/2 in. NPT nylon conduit plug (I.S./Non-Incendive)	
4TB9515-0287	M20 nylon cable gland (I.S./Non-Incendive)	
4TB9515-0288	M20 nylon conduit plug (I.S./Non-Incendive)	
4TB9515-0289	1/2 in. NPT 316 stainless steel Ex d (Explosion-proof) cable gland	

Table 11.1 Spares and Accessories

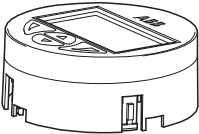
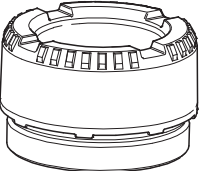
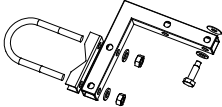

Part Number	Description	Item
4TB9515-0290	1/2 in. NPT 316 stainless steel Ex d (Explosion-proof) conduit plug	
4TB9515-0291	M20 316 stainless steel Ex d (Explosion-proof) cable gland	
4TB9515-0292	M20 316 stainless steel Ex d (Explosion-proof) conduit plug	
4TB9515-0280	Rear blind cover, plus 3 terminal block stickers (one each: EC, TE, TC)	

Table 11.1 Spares and Accessories (Continued)

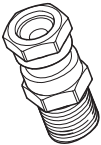
Appendix A Permits and Certification

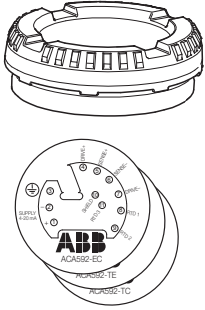

Symbol	Description
 <p>Explosion-proof approval</p>	<p>The Ex label indicates a device that complies with the directive 94/9/EC</p>
<p>CE mark</p> 	<p>The CE mark indicates that the device complies with the following directives and their basic safety requirements:</p> <ul style="list-style-type: none"> ■ CE mark on the name plate of transmitter <ul style="list-style-type: none"> – EMC directive 2004/108/EC, Low Voltage directive 2006/95/EC, ATEX directive 94/9/EC ■ For ignition-protection applications: <ul style="list-style-type: none"> – Conforms with hazardous area directive 94/9/EC <p>By placing the CE mark on its devices, ABB declares its conformance with these directives.</p>

Table A.1 Permits and Certification

Appendix B Installation Drawings

B.1 Drawing P0908

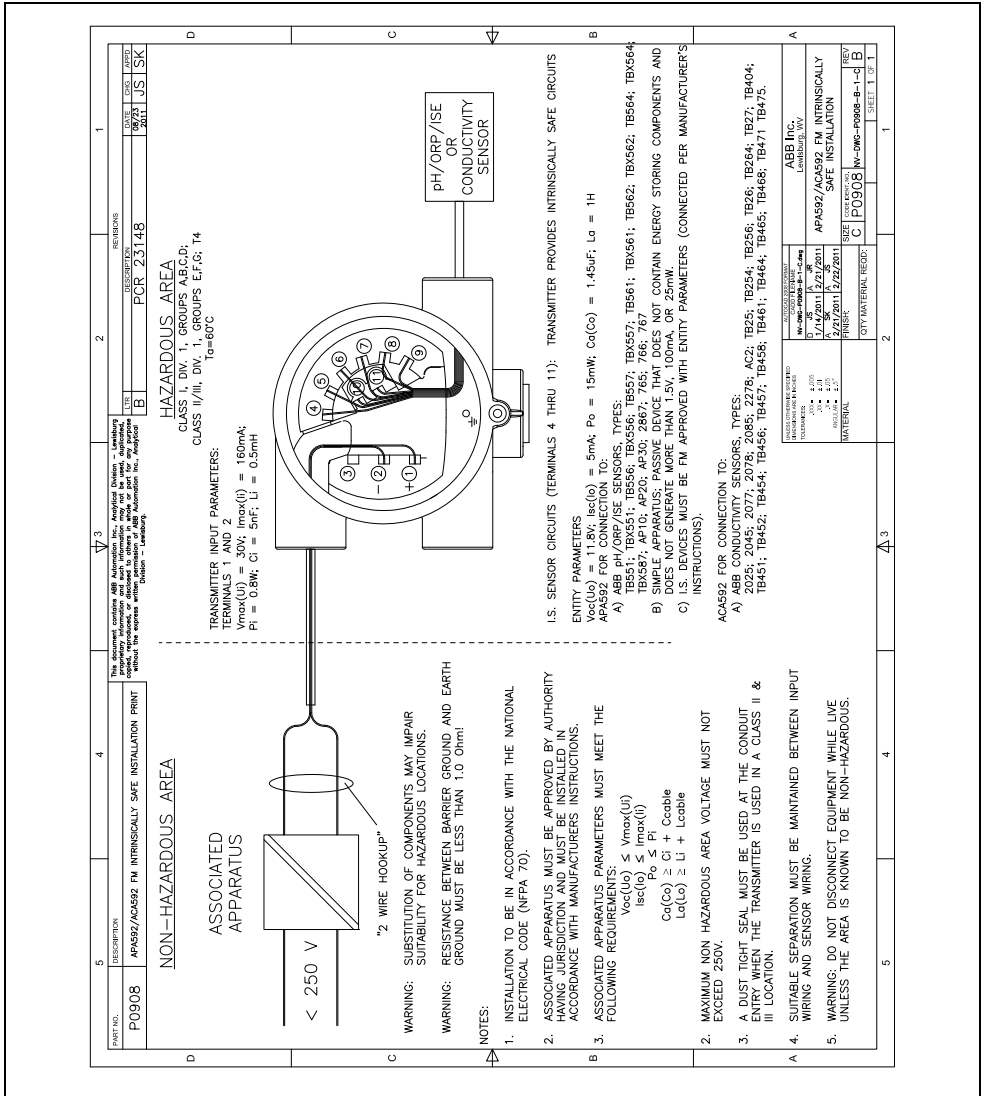
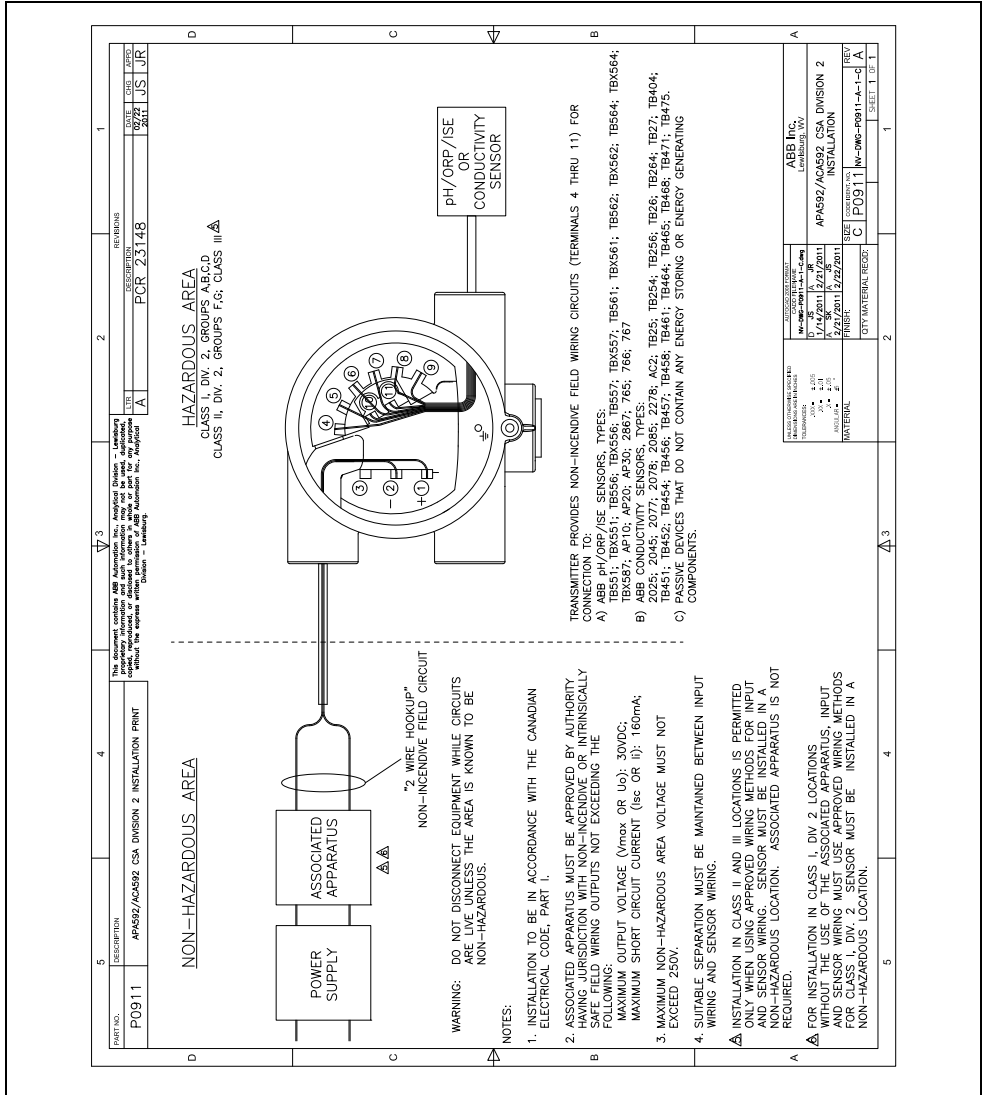

Fig. B.1 Installation Drawing P0908

B.4 Drawing P0911



Acknowledgements

- HART is a registered trademark of the HART Communication Foundation.
- Siemens is a copyright of Siemens AG.

Sales



Service



Software



ABB Inc.
Measurement & Analytics
3567 Jefferson Street N
24901, Lewisburg, WV
USA
Tel: +1 304 647 4358
Fax: +1 304 645 4236
Email analyzeit@us.abb.com

ABB Inc.
Measurement & Analytics
125 E. County Line Road
Warminster, PA 18974
USA
Tel: +1 215 674 6000
Fax: +1 215 674 7183

ABB Limited
Measurement & Analytics
Oldends Lane, Stonehouse
Gloucestershire, GL10 3TA
UK
Tel: +44 (0)1453 826 661
Fax: +44 (0)1453 829 671
Email: instrumentation@gb.abb.com

abb.com/measurement



We reserve the right to make technical changes or modify the contents of this document without prior notice. With regard to purchase orders, the agreed particulars shall prevail. ABB does not accept any responsibility whatsoever for potential errors or possible lack of information in this document.

We reserve all rights in this document and in the subject matter and illustrations contained therein. Any reproduction, disclosure to third parties or utilization of its contents – in whole or in parts – is forbidden without prior written consent of ABB.