

LST300

Compact ultrasonic level transmitter



The most powerful ultrasonic level transmitter in a compact form

Measurement made easy

For more information

Detailed operation and safety manual, training material and videos guide are available:
<https://new.abb.com/products/measurement-products/level/ultrasonic-level-transmitters-and-switches/lst300>

or by scanning this code:



Table of Contents

1	Introduction	5
2	Safety	6
	General information and notes	6
	Intended use.	6
	Improper use	6
	Target groups and qualifications	6
	Warranty provisions	6
	Operator liability	6
	Technical limit values	6
	Plates and symbols.	7
	Safety, warning and note symbols	7
3	Mounting	9
	Installation safety instructions	9
	Installation requirements.	9
	Dimensions	9
	Direct mounting variations	10
	Direct installation using a nut	10
	Direct installation using a sleeve	10
	Mounting with L-shape bracket	11
	Mounting with extendable bracket.	12
	Mounting with flanges	13
	Beam angle reference	14
	Nozzle installation	15
	To avoid false echoes	15
4	Electrical connections	16
	Cable connection area.	16
	DC power supply	17
	Analog output.	17
	HART communications	17
	Grounding	17
	Terminal connections.	18
	Wiring	19
5	Commissioning	20
	Preliminary checks prior to start-up	20
	Commissioning using the Easy Setup menu	20

6	Configuration	22
	Operation	22
	Menu navigation	22
	Menu levels	22
	Process display	22
	Switching to the information level (operator menu)	23
	Switching to the configuration level parameterization	24
	Selecting and changing parameters	24
	Overview of parameters at the configuration level	25
	Parameter descriptions	30
	Menu: Easy Setup	30
	Menu: Device Info	30
	Menu: Device Setup	31
	Menu: Display	33
	Menu: Input/Output	34
	Menu: Process Alarm	35
	Menu: Communication	35
	Menu: Diagnostics	36
	Menu: Calibrate	37
	Menu: Service	38
	Alarm Simulation	38
	Device with HART protocol	38
7	Advanced functions	39
	Signal waveform	39
	Accessing the waveform display	39
	Signal waveform display	39
	True Echo Detection	41
	Accessing the True Echo Detection menu	41
	Configuring True Echo Detection	41
	Volume	42
	Example tank	43
	Configure the level settings	43
	Configure the volume unit	44
	Configure the linearization table	44
	Open channel flow	45
	Open channel flow on DTM	46
	Open channel flow on EDD	48
	Calibration	49
	Ultrasonic level calibration	49
	Dry calibration	49
	Wet calibration	50
8	Diagnostic messages	52

9	Ex relevant specifications	53
	Meter design for general purpose, Ex protection code Y053
	Meter design for NEPSI non sparking, ATEX/IECEX/UKCA energy limited (Zone 2 /22), cFMus division 2, Zone 2/22.53
	Meter design for NEPSI intrinsic safety, ATEX/IECEX/UKCA intrinsic safety (Zone $\frac{1}{20}$), and cFMus division 1, Zone 0/2054
	Meter design for NEPSI intrinsic safety, ATEX/IECEX/UKCA intrinsic safety (Zone $\frac{1}{20}$), and cFMus division 1, Zone 0/2055
	Specific Conditions of Use	56
10	Specification	57
	Measurement57
	Mechanical data.57
	Electrical data.57
	Displays (option)57
	Hazardous area approvals58
	Environmental data58

1 Introduction

Liquid level measurement has never been easier.

LST300 is the most advanced compact level instrument available. With class leading accuracy and specification typically only found in expensive remote sensor units, LST300 changes the way the world looks at compact ultrasonic transmitters.

LST300 features high temperature range, corrosion resistant design, metal housing, intrinsic safety, advanced diagnostics, false echo filtering and even real time on-screen graphic echo view. The LST300 can be installed in areas where compact instruments were never an option.

LST300 solves many liquid level challenges in liquid storage tanks and liquid processes in a wide range of industries, including:

- Water and wastewater
- Chemical and petrochemical
- Power
- Paper and pulp
- Mining and metals
- Food and beverage

2 Safety

General information and notes

Read these instructions carefully prior to installing and commissioning the device.

These instructions are an important part of the product and must be kept for future reference.

These instructions are intended as an overview and do not contain detailed information about all design variations of this product or every possible aspect of installation, operation and maintenance.

For additional information, or if specific problems occur that are not detailed in these instructions, contact the manufacturer.

The content of these instructions is neither part of any previous or existing agreement, promise or legal relationship, nor is it intended to change the same.

This product is designed with state-of-the-art technology and is operationally safe. It left the factory pre-tested for safety and in perfect working order. The information in this manual must be observed and followed in order to maintain safe and optimal function throughout the period of operation.

Modifications and repairs to the product may be performed only if expressly permitted by these instructions or ABB technical support.

Observe all of the instructions and the safety and warning symbols to ensure optimum protection of personnel and the environment, as well as safe and fault-free operation of the device.

Information and symbols on the product must be observed. They may not be removed and must be fully legible at all times.

Intended use

This device is intended for the following uses:

- To measure distance to a liquid surface (directly, using time-of-flight through air)
- To measure the level of liquids in tanks (indirectly, using distance measurement and tank dimensions)
- To measure volumetric flow (indirectly using distance measurement and tank dimensions)
- To measure the volume (indirectly using distance measurement and tank dimensions)

Using these products as intended involves observing the following points:

- Read and follow the instructions in this manual
- Observe the technical ratings (refer to chapter 10 "Specification")

Improper use

The following are instances of improper use of the device:

- Measuring in a medium other than air, for example in the presence of heavy gas vapors
- Use as a climbing aid, for example for mounting purposes
- Use as a support for external loads, for example to support the tank, etc
- Addition of material, for example by painting over the name plate or welding/soldering on parts
- Removal of material, for example by spot drilling the housing

Target groups and qualifications

Installation, commissioning and maintenance of the product may be performed only by trained specialist personnel who have been authorized by the plant operator to do so. The specialist personnel must have read and understood the manual and comply with its instructions.

The operators must strictly observe the applicable national regulations with regard to installation, function tests, repairs, and maintenance of electrical products.

Warranty provisions

Using the device in a manner that does not fall within the scope of its intended use. Disregarding this manual, using unqualified personnel, or making unauthorized alterations releases the manufacturer from liability for any resulting damage. This renders the manufacturer's warranty null and void.

Operator liability

Installation, operation, maintenance and servicing must only be carried out by suitably trained personnel and in accordance with the information given. Any deviation from these instructions will transfer the complete liability to the user.

Technical limit values

Particular attention must be paid to the limit values listed in the sections relating to ex relevant specifications (refer to chapter 9, "Ex relevant specifications"):

- The data for the signal inputs and outputs of the transmitter
- The permissible temperature data and limit values

Plates and symbols

Safety, warning and note symbols

DANGER

The signal word '**DANGER**' indicates an imminent danger. Failure to observe this information will result in death or severe injury.

WARNING

The signal word '**WARNING**' indicates an imminent danger. Failure to observe this information may result in death or severe injury.

CAUTION

The signal word '**CAUTION**' indicates an imminent danger. Failure to observe this information may result in minor or moderate injury.

NOTICE

The signal word '**NOTICE**' indicates potential material damage.

Note

'**Note**' indicates useful or important information about the product.

IMPORTANT (NOTE)

The name plates shown here are only examples. The name plates attached to the device may be different to what you see here.

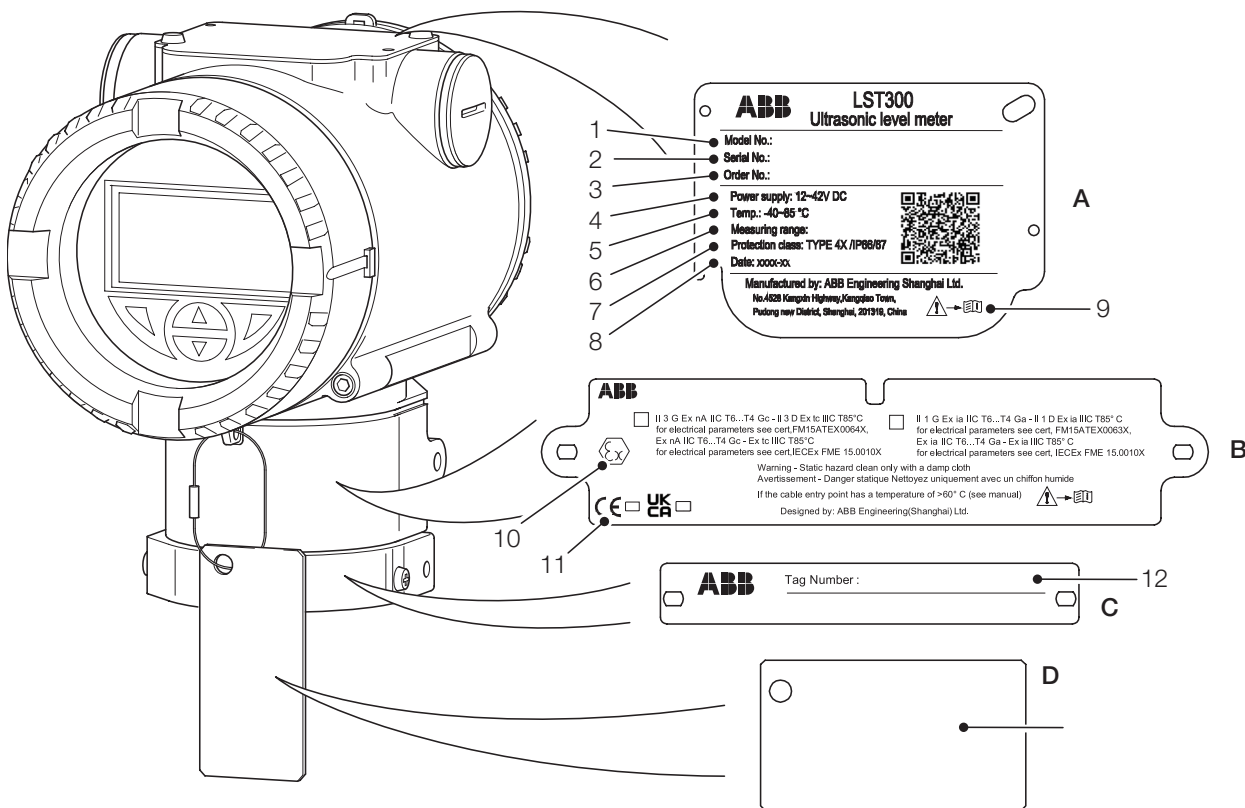

Figure 1 Product labels for LST300

1	Model number
2	Serial number for identification by the manufacturer
3	Order number
4	Power supply
5	Ambient temperature
6	Measuring range
7	Protection type according to EN 60529
8	Year / Month of manufacture
9	Alarm sign (read the instruction before using it)
10	Ex mark (example)
11	CE, UKCA mark
12	Tag number

B	Certification plate
C	Tag plate
D	Wired-On plate

3 Mounting

Installation safety instructions

Details of any damage that has occurred in transit must be recorded on the transportation documents. All claims for damages must be submitted to the shipper without delay and before installation.

Installation requirements

An LST300 level transmitter can be installed in many applications you need. Consider the following installation conditions:

- Ensure the instrument is installed within recommended temperature and pressure ratings.
- Try to avoid mounting LST300 in the middle of the tank or too close (less than 200mm) to the wall
- If installed in a conically shaped vessel, ensure that the sensor is installed just above the lowest point in the tank
- The sensor surface should be in parallel with the product surface
- Avoid two sensors in the same tank, or use sound guide pipes to avoid signals' interference from each other
- Standpipe/nozzle's length should be as short and the diameter as large as possible

- Avoid buildup, weld, couplings, other obstacles like switches, ladders, baffles within the nozzle or sensor beam angle
- The actual Max. measuring range depends on the operating conditions, refer to below table to estimate the actual measuring capability:

Actual operating conditions	Attenuation (% of the ideal range)
Calm liquid surface	0%
Waves or turbulence	0%~20% (strong)
Dust and vapor	0%~20% (heavy)
Hot surface	0%~20% (50°C+ higher than ambient)
Foaming	60%~100% according to the foam size
Solid—Hard surface	0%~40%
Soft/porous surface	60%
Nozzle/Pipe	0%~80% depending on the dimension and inner wall roughness

Note

The attenuation is the feature of ultrasound, not the capability of the device

Dimensions

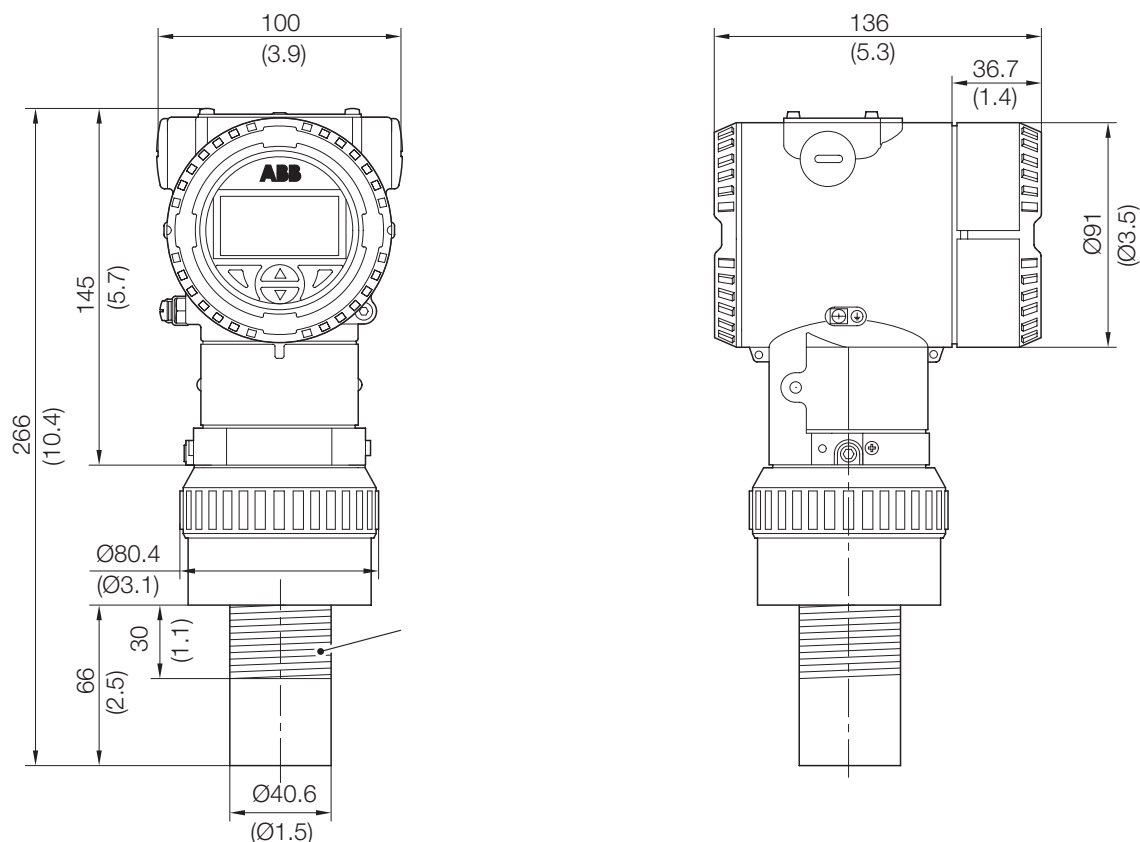

Figure 2 Transmitter with 1.5 inch thread

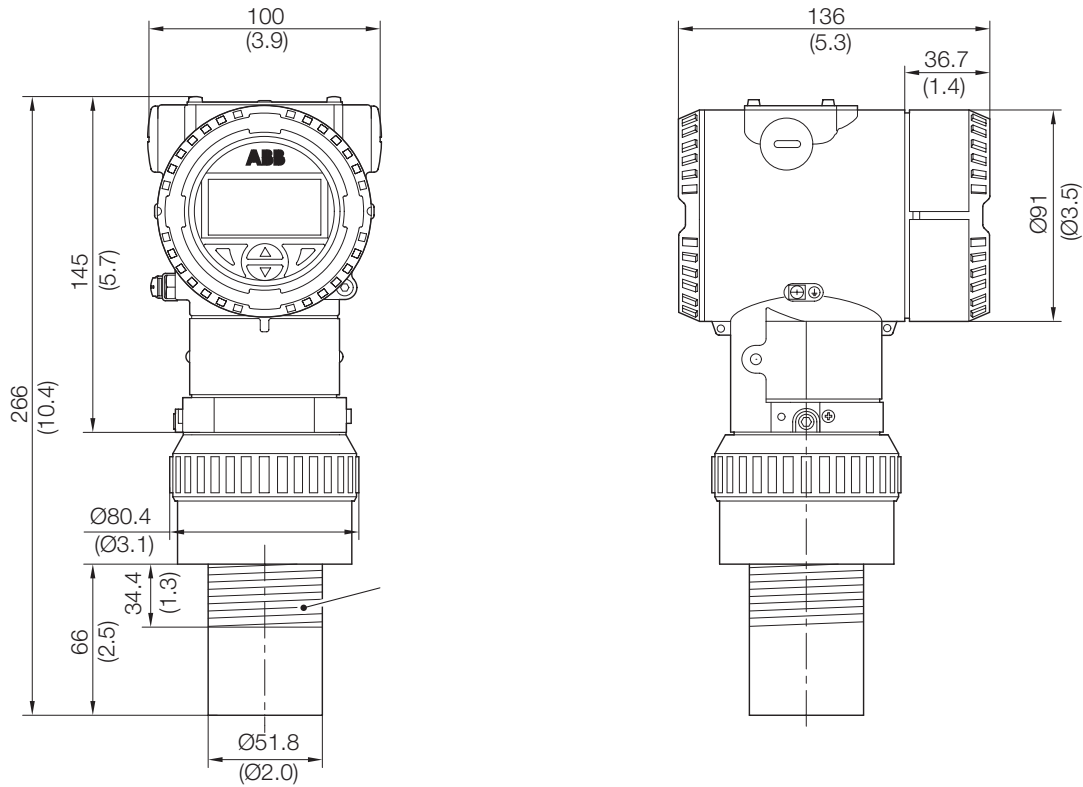

Figure 3 Transmitter with 2 inch thread

Direct mounting variations

The LST300 transmitter can also be mounted directly on a tank using either a nut or a sleeve.

Direct installation using a nut

- 1 Drill a 60 mm (2.4 in) hole (for both U5 and U2 process connection) into the tank.
- 2 Fit a seal to the LST300 transmitter, insert the transmitter through the hole and secure from inside the tank using the nut.

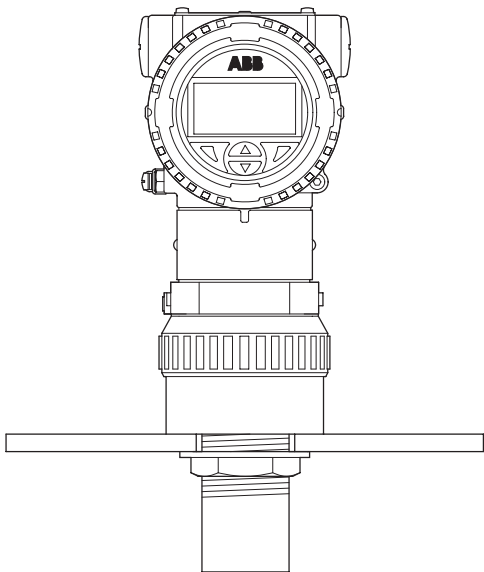

Figure 4 Direct installation using a nut

Direct installation using a sleeve

- 1 Select a sleeve that is compatible with NPT or BSP thread. The LST300 transmitter's thread size is 1.5 in. (for the 75 KHz version) or 2 in. (for the 50 KHz version).
- 2 Fit a seal to the LST300 transmitter and screw the transmitter into the sleeve by hand.

Note

Tighten the transmitter hand-tight only. Do not use tools.

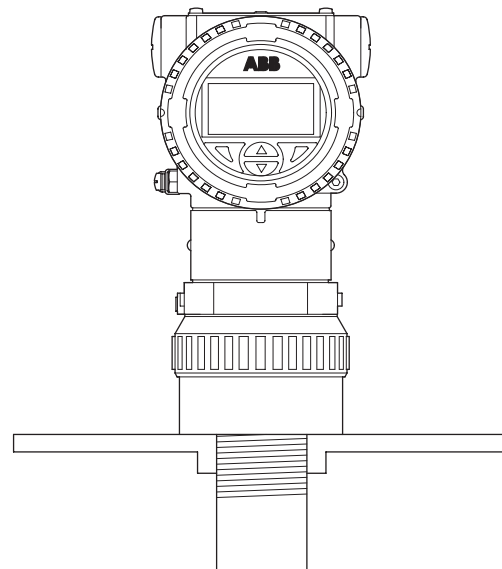

Figure 5 Direct installation using a sleeve

Mounting with L-shape bracket

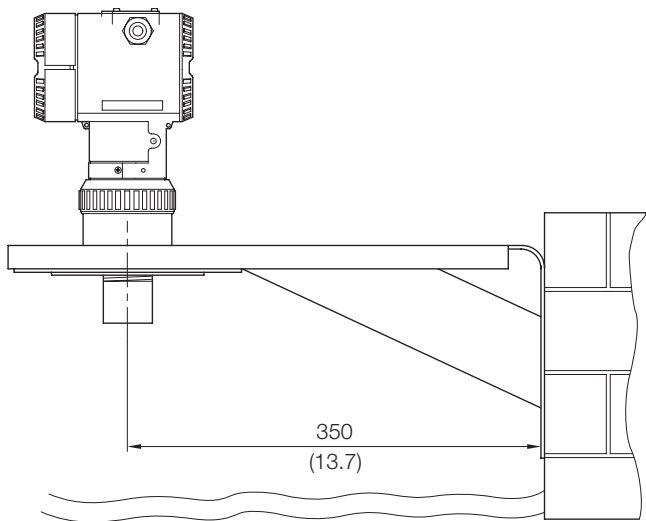

Figure 6 Wall mounting with L-shape bracket

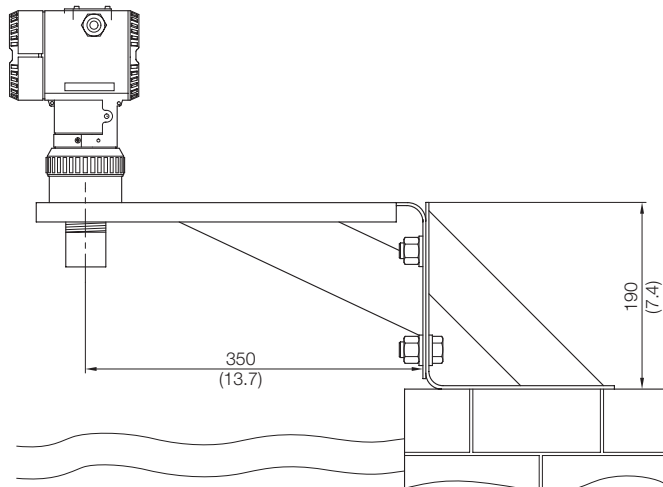

Figure 8 Floor mounting with L-shape bracket

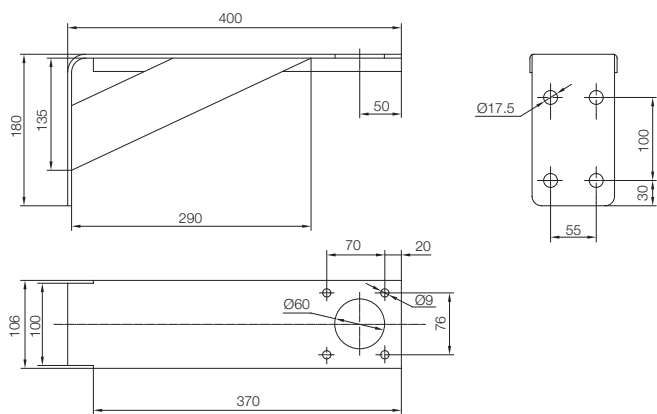

Figure 7 L-shape bracket

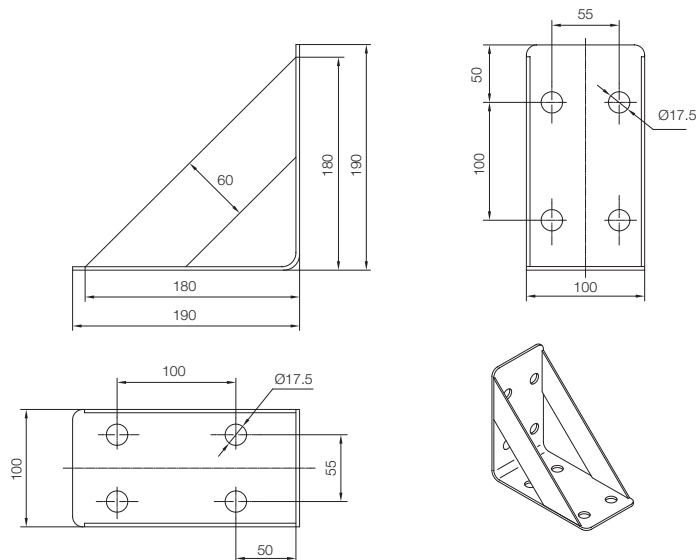

Figure 9 Floor mounting support

Mounting with extendable bracket

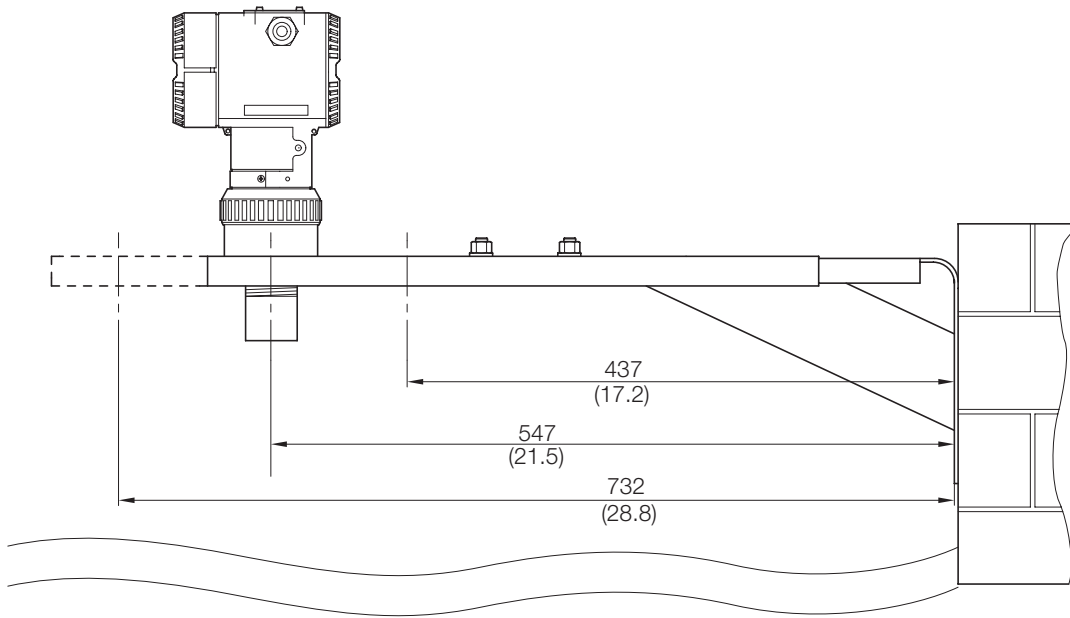

Figure 10 Wall mounting with extendable bracket

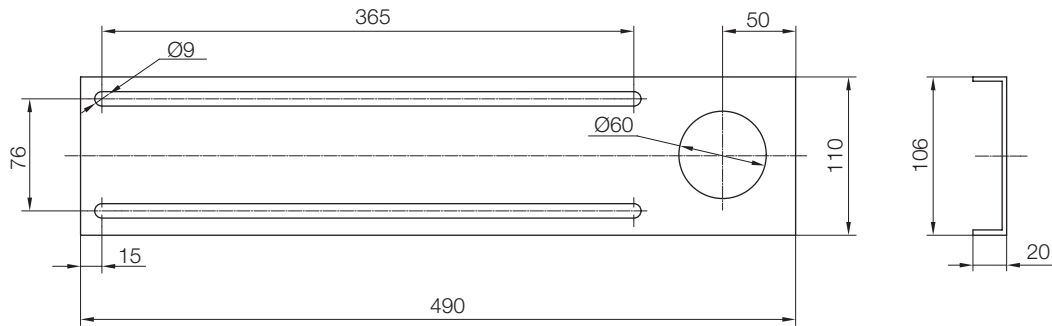

Figure 11 Extendable portion

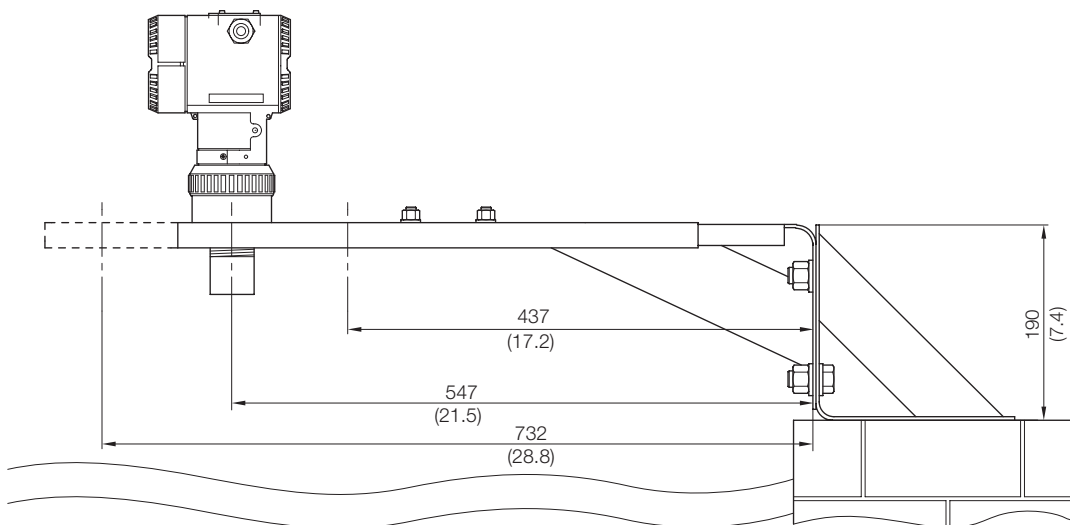

Figure 12 Floor mounting with extendable bracket

Mounting with flanges

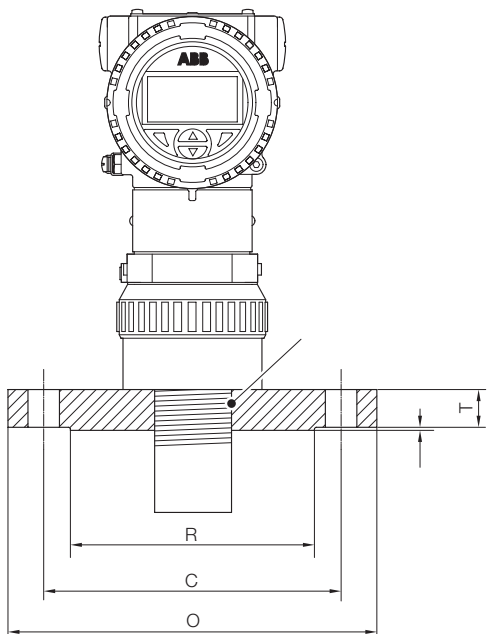

Figure 13 Mounting with ANSI B16.5 flange with 1.5" and 2" NPT thread

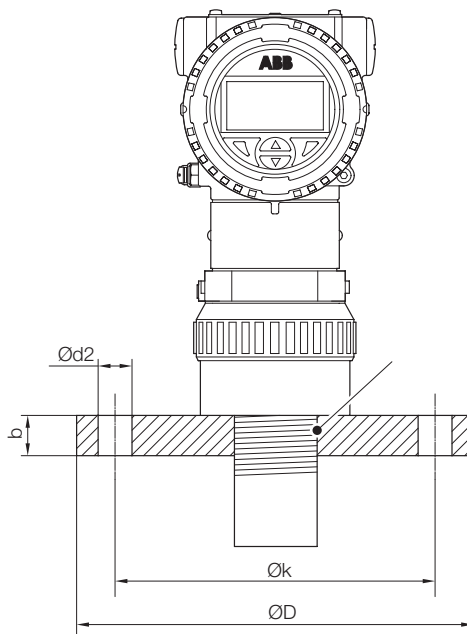

Figure 14 Mounting with DIN2527 flange with 1.5" and 2" NPT thread

ANSI B16.5 class 150 blind flanges								
Nominal pipe size	Outside diameter (O)	Thickness (T)	Raised face diameter (R)	Number of holes	Diameter of bolt holes	Bolt circle diameter (C)	Approximate weight (lbs)	Thread P
3	7.5	0.94	5	4	0.75	6	9	1.5" or 2" NPT THREAD
4	9.0	0.94	6.19	8	0.75	7.5	17	
6	11	1.00	8.5	8	0.88	9.5	26	

Table 1 Types of ANSI B16.5 class flanges for option

The dimensions are in inches.

DIN2527.PN16.Shape B								
Rated diameter	Flange			Screws			Weight of flange (7.8 Kg/dm ³)	Thread P
	D	b	k	Number	Thread	d2	Shape B (Kg)	
80	200	20	160	8	M16	18	9	1.5" or 2" NPT THREAD
100	220	20	180				17	
150	285	22	240	M20	22	26		

Table 2 Types of DIN2527 flanges for option

The dimensions are in mm.

Beam angle reference

LST300 shall be mounted in a proper position with no big blocks, e.g. filling point, pipes or wall within the beam angle area.

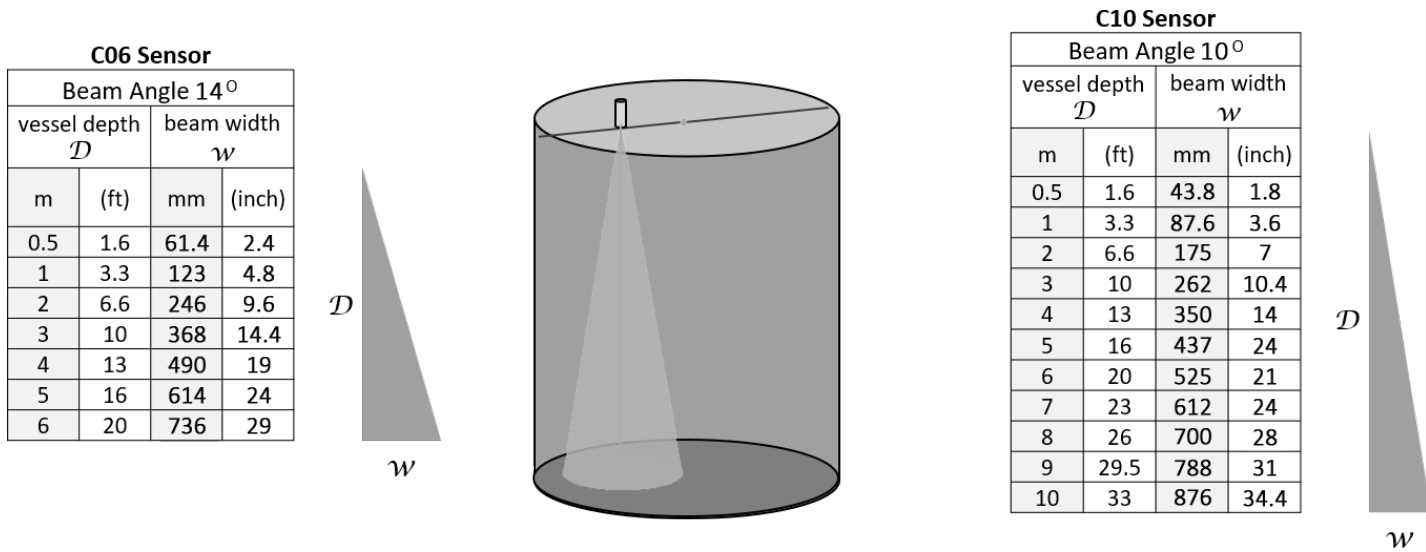

Figure 15

Note

If the blocks within the beam angle area cannot be avoided, the device can still work with shorter measuring range or sometimes true echo detection (diagnostics menu) function need to be enabled to filter fake echo from the blocks.

Transducer perpendicular to liquid level.

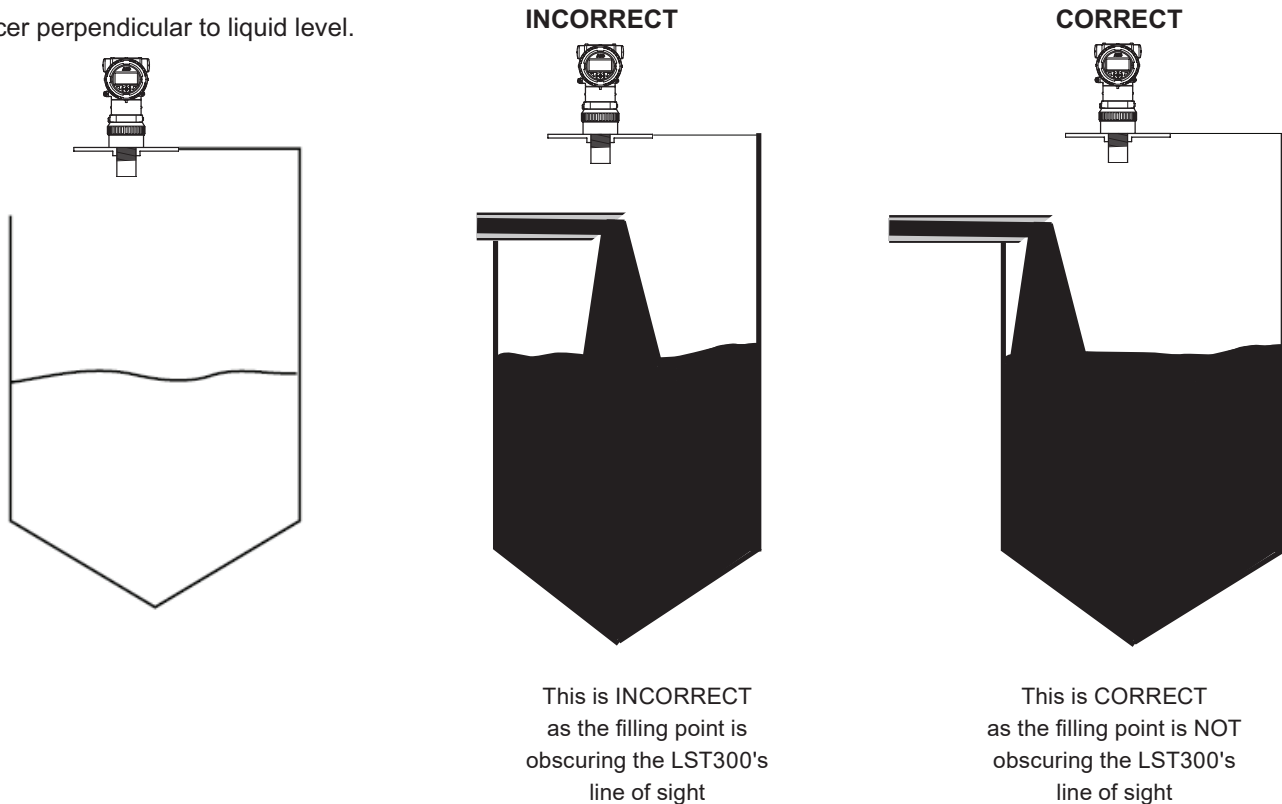

Figure 16

Nozzle installation

For easier installation or keeping a safety distance “S” between the blanking area and upper range limits (URV), you may need the help of a pipe nozzle to install the instrument at a certain height. The interior of the nozzle must be smooth without burrs or joints and a 45-degree angle edge would be ideal to minimize the disturbance. The limits of the nozzle are as below:

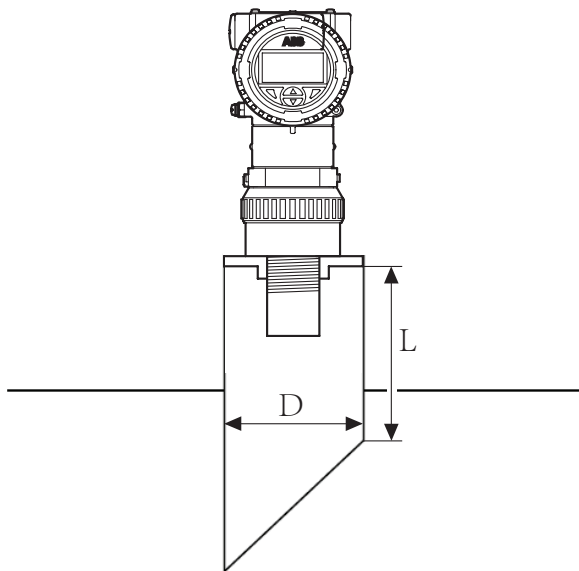

Figure 17

Better to ensure the diameter of the nozzle pipe D is larger than 120mm and $L/D \leq 3$, or refer to the table below:

C10-50kHz		C06-75kHz	
D	L	D	L
80	180	50	120
100	225	80	200
150	345	100	300
200	450	150	450
250	800	200	600
300	1500	250	800
		300	1500

To avoid false echoes

A PE or PVC pipe may be needed to guide the ultrasound when the false echoes from the obstacles were strong, and the recommended pipe inner diameter is no less than 150 mm (300 mm if there are joints for longer pipe).

Note

A vent is needed on the upper side of the pipe.

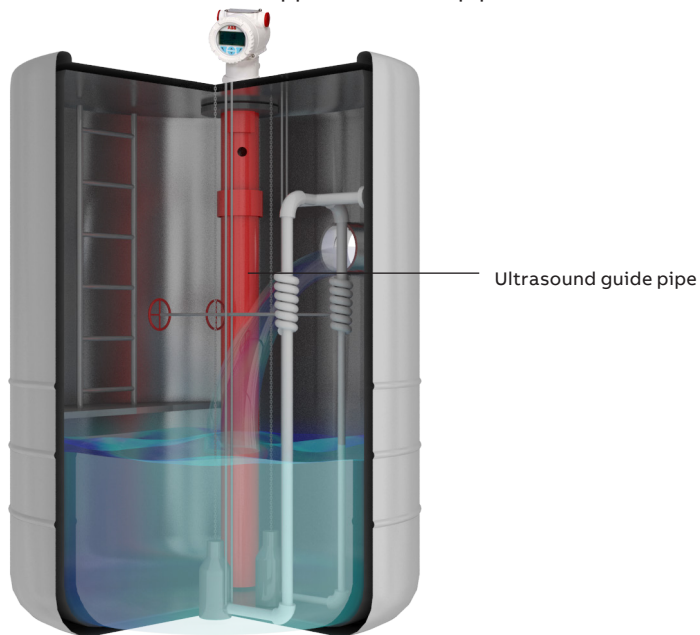

Figure 18 Ultrasound guide pipe installation

4 Electrical connections

Before installation, ensure the LST300 is not plugged in to any power supply.

Installation engineers must statically discharge themselves or use a wrist strap before connecting cables to LST300.

Check the LST300 power supply to ensure that it does not exceed the permitted range (12 to 42 V DC).

When the terminal cover of the LST300 is open, protect the inside of the transmitter against the ingress of dust and moisture.

⚠ WARNING – BODY INJURY

Not recommend for hot plugging power

The LST300 does not recommend hot plugging power (4 to 20 mA with HART).

Shut down the power supply before connecting the LST300 to the power supply.

Le LST300 ne recommande pas la puissance chaude de bouchage (4 - 20 mA avec Hart).

Arrêtez l'alimentation avant de connecter le LST300 à l'alimentation

NOTICE – PROPERTY DAMAGE

Material damage due to electrostatic discharge

An open cover does not provide contact protection. Touching conductive components can damage electronic components (in some cases beyond repair) due to electrostatic discharge. Do not touch conductive components.

LST300 connections have ESD 4 kV protection for contact and 8 kV for air in accordance with IEC 61000-4-2. ABB strongly recommends using a wrist strap or to discharge electrostatic charge before connecting cables to the LST300.

Cable connection area

The electrical wiring is fitted to the LST300 using a 1/2-14 NPT or a M20 x 1.5 cable gland. To ensure the transmitter's NEMA 4X and IP 66/67 ingress protection rating is maintained, apply a suitable sealing compound to the cable gland threads before screwing the gland into the housing (1/2 in. NPT or M20 x 1.5 female thread).

⚠ DANGER – SERIOUS DAMAGE TO HEALTH / RISK TO LIFE

When installing the LST300 measuring system in hazardous areas, all national standards and the specifications in the safety instructions must be complied with and the specified cable gland must be used.

NOTICE – PROPERTY DAMAGE

- Do not screw the terminal cover on with the cable gland tightened.
- Route a single cable only through the cable gland. Multiple cables will compromise the transmitter's ingress protection.
- After connecting the terminals, ensure the terminal cover is tightened.

IMPORTANT (NOTE)

The red plugs must be removed when the transmitter is installed in a hazardous area. They are not explosion-proof certified products.

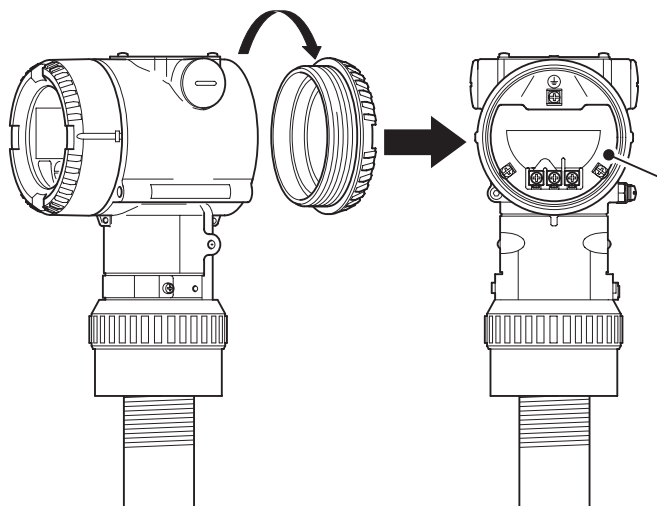

Figure 19 Cable connection area

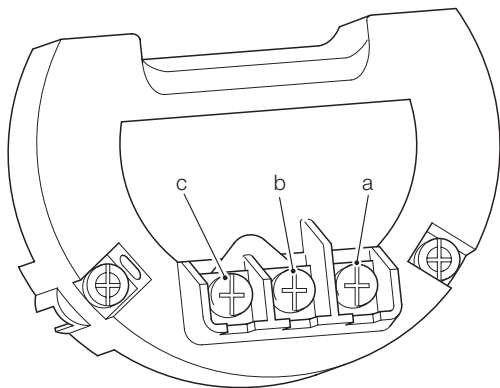

Figure 20 Termination introduction

a	Positive polarity of power supply (+)
b	Negative polarity of power supply (-)
c	Extend meter, shorted with negative polarity for normal use (Ext)

DC power supply

The LST300 operates from a DC power supply that is connected to the terminals shown in Fig. 15.

- Open the blind cover first to connect the cable.
- The power supply voltage is 12 to 42 V DC without surge protection, and 14 to 42 V with surge protection when the - and Ext Meter terminals are shorted.
- It is recommended to use twisted pair cables for better resistance to electrical disturbance.

Analog output

LST300 has a 4 to 20 mA analog output to transmit measurements and alarms.

- The 4 to 20 mA output and power supply input share the same wires.
- The output current is the process variable during normal conditions. It can also be a fixed value as a failsafe or to indicate alarm conditions.
- The current output range of a valid signal is 4 to 20 mA.
- The Low Alarm value is configurable in the range of 3.5 mA to 3.6 mA.
- The High Alarm value is configurable in the range of 21 mA to 22.6 mA.
- The refresh frequency of the 4 to 20 mA output is 0.2 second.

HART communications

The HART protocol is used for digital communication between a process control system / PC, a handheld terminal, and LST300. It can be used to send all device and measuring point parameters from the transmitter to the process control system or PC. Conversely, it also provides a means of reconfiguring the transmitter. Digital communication utilizes an alternating current superimposed on the analog output (4 to 20 mA) that does not affect any meters connected to the output.

- The HART communication shares the cable with the power supply. No additional wires are required.
- An extra resistor is needed for HART communication. The minimum value of resistor is 250 ohm. The resistor in power line causes voltage drop, and should be considered to ensure the power supply to the LST300 remains above the minimum rated input voltage.
- The baud rate of the HART communication is 1200.

Grounding

The LST300 requires a ground connection to the terminal as shown in Fig. 16.

- The LST300 provides two connectors for ground (PE). An effective ground connection is needed for optimum EMC protection.
- All grounding must comply with anti-explosion regulations if the LST300 transmitter is to be used in hazardous environments (Zone 1 Div 1 and Zone 1 Div 2).

Terminal connections

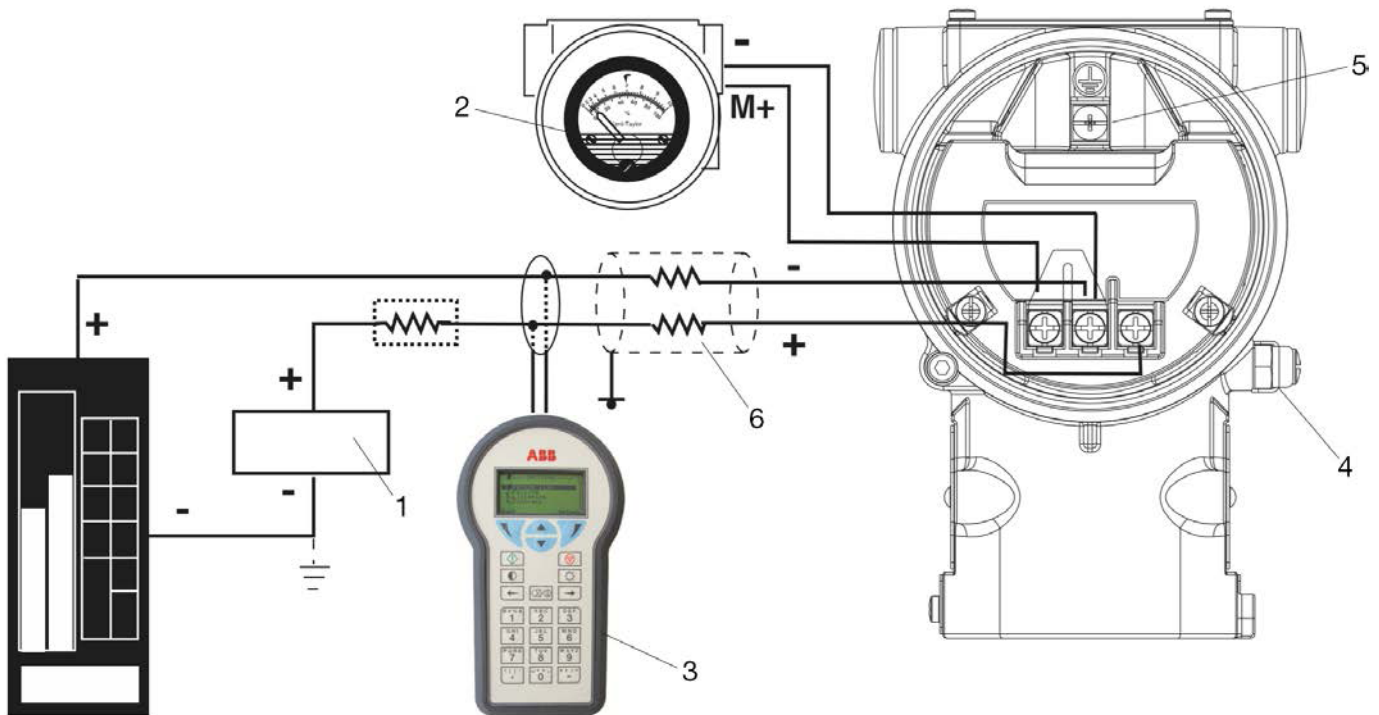

Figure 21 Electrical connection – HART version

1	Power supply
2	Remote display
3	Handheld terminal
4	External ground connection
5	Internal ground connection
6	Cable entry

⚠ WARNING

Explosion-proof transmitter must be either repaired by the manufacturer or approved by a certified expert following repair work. Observe the relevant safety precautions before, during and after repair work.

Émetteur-déflagrant doit être soit réparé par le fabricant ou approuvé par un expert agréé suite à des travaux de réparation. Respectez les précautions de sécurité nécessaires avant, pendant et après les travaux de réparation.

Wiring

Wire the transmitter as follows:

- 1 Remove the cap from one of the two electrical connection ports located at both sides in the upper part of the transmitter housing.
- 2 If needed, fit various adaptors and bushings to the ½ inch internal NPT threads of the connection ports to comply with plant wiring (conduit) standards.
- 3 Remove the housing cover of field terminals, side. However, in an explosion-proof installation, do not remove the transmitter covers when power is applied to the unit.
- 4 Run wiring through the open port. Connect the positive lead to the + terminal and the negative lead to the – terminal.

IMPORTANT (NOTE)

Do not connect the power across the test terminals, which could damage the test diode in the test connection.

- 5 Plug and seal the electrical ports. Make sure that when the installation is completed, these openings are properly sealed against entry of rain and corrosive vapors and gases.
- 6 If applicable, install wiring with a drip loop. Arrange the drip loop so that the bottom is lower than the conduit connection and the transmitter housing.
- 7 Put back the housing cover, turn it to seat O-ring into the housing, and then continue to manually tighten the cover until it contacts the housing metal-to-metal.

IMPORTANT (NOTE)

Remove the red plastic cover from the unused port and seal with proper plug so as to reduce the Reduce the long-term risk of dampness.

5 Commissioning

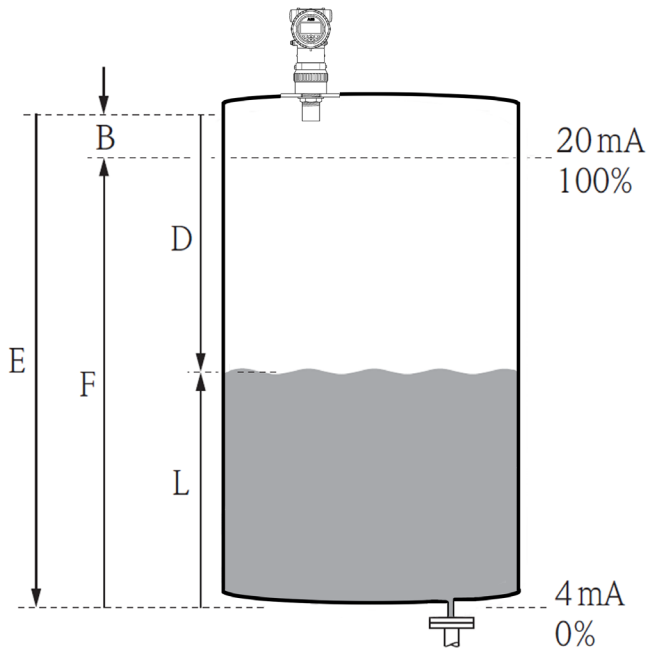

Figure 22

B	Blanking
E	Empty
F	Full
D	Distance
L	Level

Preliminary checks prior to start-up

Before beginning the commissioning procedure, ensure:

- The power supply is OFF.
- The power supply is within the specified range (12 to 42 V DC).
- The pin assignment matches the connection diagram.
- The transmitter is correctly grounded.
- The transmitter is within temperature limits.
- The transmitter is installed in a location free of vibration.
- The terminal cover is sealed.

Commissioning using the Easy Setup menu

The most common configuration parameters are summarized in the Easy Setup menu. This menu provides the quickest way to configure the device.

For a detailed description of these menus and parameters, see section “Parameter descriptions”.

- 1 Log on to the LST300 at the **Standard** or **Advanced** level.



- 2 Select **Easy Setup** in the main menu.

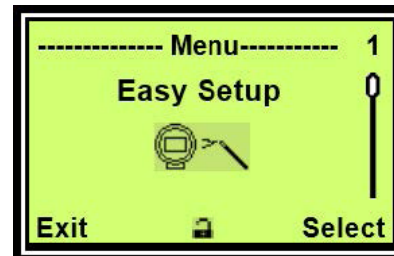

- 3 Select a language in the “Easy Setup” menu and press



- 4 Select an option of **Operation Mode** in the “Easy Setup” menu and press .

The options available are *Level*, *Flow* and *Volume*.

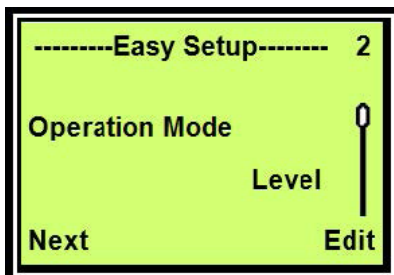

5 Configure **Empty Distance** and press .

Note

Empty Distance is the distance from the face of the sensor to the bottom of the tank. In Level mode, **Empty Distance** indicates the distance from the sensor where the tank is empty.

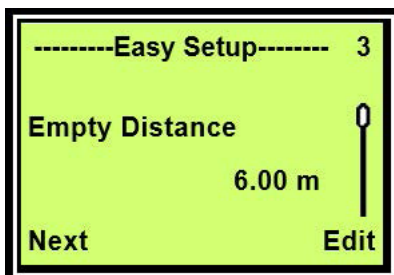

6 Configure **Span** and press .

Note

Span is the distance from the bottom of the tank to the top of the tank. In Level mode, **Span** indicates the tank full position.

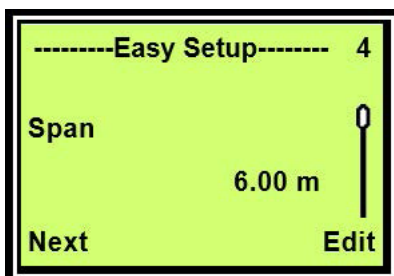

7 Configure **Blanking** and press .

Note

Blanking is the area close to the transmitter where meaningful measurements cannot be made. The default value depends on the product specification. Adjusting **Blanking** is optional.

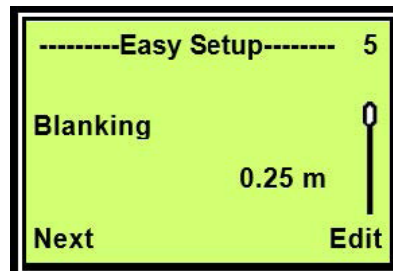

8 Configure **Max Change Rate**.

Note

Max Change Rate indicates the maximum change rate of measuring distance or level.

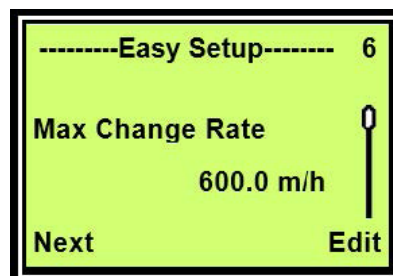

6 Configuration

Operation

The LCD display is provided with optional capacitive control buttons. When this option is selected, device control through the glass of the closed cover is enabled.

The default instrument offers standard push buttons.

IMPORTANT (NOTE)

When the capacitive control button option is selected, the transmitter automatically calibrates the buttons on a regular basis. If the cover should be opened during operation, the button sensitivity is increased at first. As a result, operating errors may occur. The button sensitivity returns to normal during the next automatic calibration.

Menu navigation

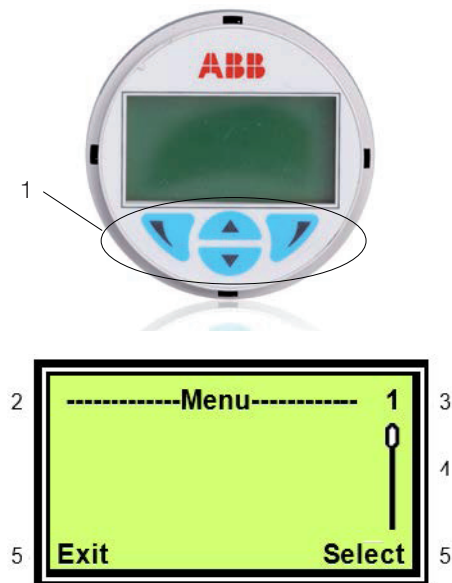

Figure 23 LCD indicator

1	Control buttons for menu navigation
2	Menu name
3	Menu number
4	Marker for indicating relative position within the menu
5	Functions currently assigned to the and control buttons

Control buttons

	Meaning
	Exit the menu
	Go back to the upper level menu
	Cancel a parameter entry
	Select the next position for entering numerical and alphanumeric values

	Meaning
	Select a submenu or parameter
	Edit parameter
	Save the entry

Menu levels

Two levels exist under the process display.

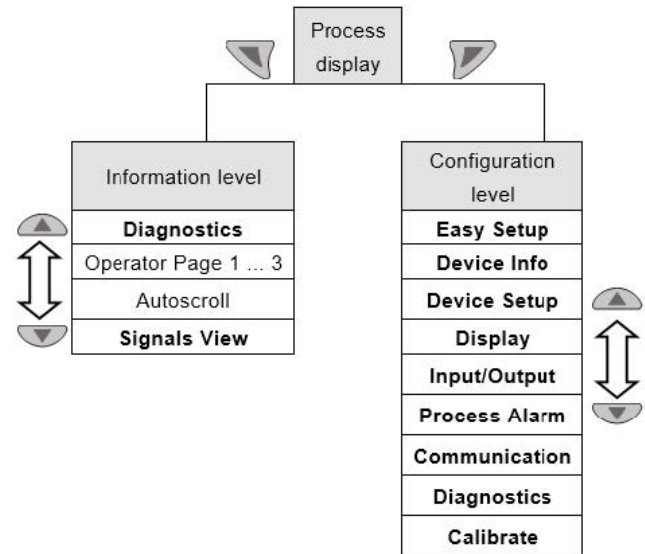

Figure 24 Menu levels

Process display	Display process data
Information level	Access diagnostics and operator pages
Configuration level	Configure the device

IMPORTANT (NOTE)

For a detailed description of the individual parameters and menus on the configuration level, refer to section “Overview of parameters on the configuration level” and section “Parameter descriptions”.

Process display

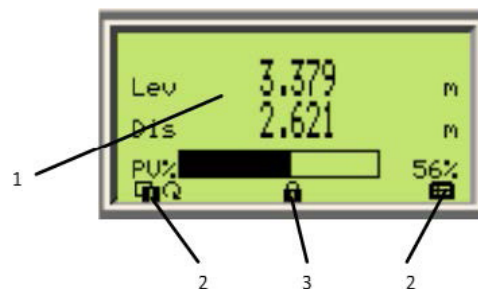





Figure 25 Process display

1	Present process values
2	Symbol indicating button function
3	Symbol indicating “Parameterization protected”

The process display appears when the device is switched on. It shows information about the device and the present process values.

The way in which the present process values (1) are shown can be adjusted at the configuration level.

Description of symbols

Symbol	Description
	Call up information level. When Autoscroll mode is enabled, a \cup symbol appears here and the operator pages are automatically displayed one after the other.
	Call up configuration level.
	The device is protected against changes to the parameter settings.
Q	Display of the current flowrate
$\Sigma+$	Totalizer status in forward direction
$\Sigma-$	Totalizer status in reverse direction

Switching to the information level (operator menu)

On the information level, the operator menu can be used to display diagnostic information and select which operator pages to display.

- 1 Press  to switch to the information level.

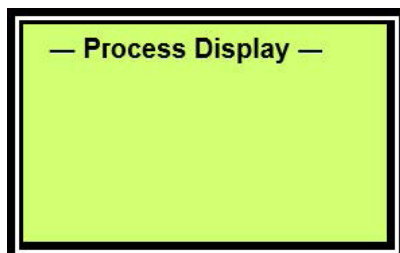

- 2 Press  or  to select a submenu.

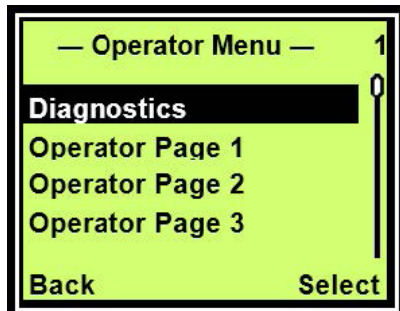

- 3 Press  to confirm your selection

Menu	Description
... / Operator Menu	
Diagnostics	Select the "Diagnostics" submenu. See also chapter 7 "Diagnostic Messages".
Operator Page 1	Select the operator page to be displayed
Operator Page 2	Select the operator page to be displayed
Operator Page 3	Select the operator page to be displayed
Operator Page 4	Select the operator page to be displayed



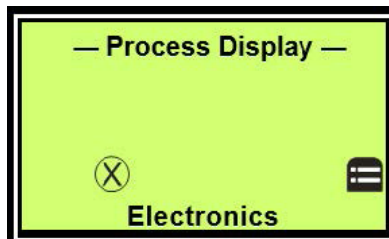

Menu	Description
Autoscroll	Initiates automatic switching of the operator pages on the process display when "Multiplex Mode" is enabled.
Signals View	Select the "Signals View" submenu (for service only).

Error messages on the LCD display

In case of an error, a message consisting of an icon and text appears at the bottom of the process display. The displayed text indicates where the error has occurred.



The error messages are divided into the following four groups:

Symbol	Description
	Error / Failure
	Functional check
	Out of specification
	Maintenance required



Additionally, an error message indicates one of the following areas where the error has occurred:

Area	Description
Electronics	Error / Alarm of the electronics.
Sensor	Error / Alarm of the flow meter sensor
Status	Alarm due to the present device status
Operation	Error / Alarm due to the present operating conditions

Invoking the error description

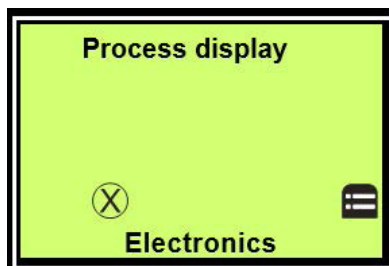
- 1 Press  to switch to the information level.



- 2 Press  or  to select the “Diagnostics” submenu.

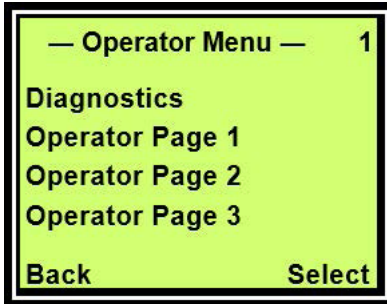

- 3 Press  to confirm your selection

The first line indicates where the error has occurred.
The second line shows the unique error number.
The next lines show a brief description of the error and its remedy information.



IMPORTANT (NOTE)

Refer to chapter 7 “Diagnostic Messages” for a detailed description of the errors and remedy information.

Switching to the configuration level parameterization

The device parameters can be displayed and changed on the configuration level.

- 1 Press  to switch to the information level.



- 2 Press  or  to select an access level.



- 3 Press  to confirm your selection

IMPORTANT (NOTE)

There are four access levels as follows:

- At the “Read Only” level all entries are disabled. Parameters are read only and cannot be modified.
- At the “Standard” level you can edit all parameters except for those written in italics.
- At the “Advanced” level all parameters can be modified.
- The Service menu is reserved to the customer service. Passwords can be defined for the “Standard” and “Advanced” levels. There are no factory default passwords. Password can be edited or reset once you have logged on to the corresponding access level. To reset to the “No password defined” state, select “-” as the password.

- 4 Enter the corresponding password (see section “Selecting and changing parameters”).

Note

There is no factory default password. You can switch to the configuration level without entering a password.

Note

The selected access level remains active for 3 minutes. Within this time period, you can toggle between the process display and the configuration level without re-entering the password.



- 5 Press  to switch to the information level. The LCD display now indicates the first menu item at the configuration level

- 6 Press  or  to select a menu.

- 7 Press  to confirm your selection



Selecting and changing parameters

Selecting a parameter value

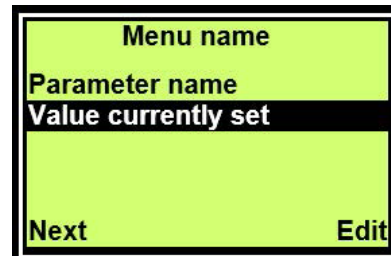
- 1 Select the parameter you want to set in the menu.



- 2 Press  to see the list of available parameter values. The parameter value that is currently set is highlighted.

- 3 Press  or  to select the required value.

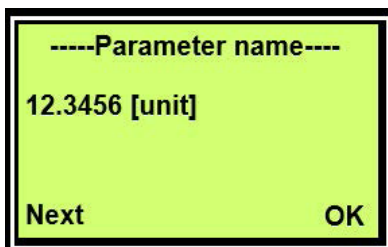



- 4 Press  to confirm your selection



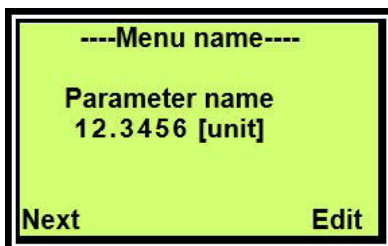

Setting a numerical parameter

- 1 Select the parameter you want to set in the menu.

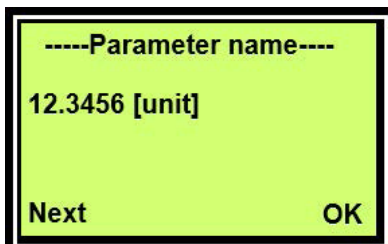

- 2 Press  for parameter editing. The currently selected position is highlighted.
- 3 Press  to select the decimal position to be changed.



- 4 Press  or  to select the required level.
- 5 Press  to select the next position.
- 6 If necessary, select and set other decimal positions using the same procedure as described in steps 3 and 4.
- 7 Press  to confirm your setting

Setting an alphanumeric parameter



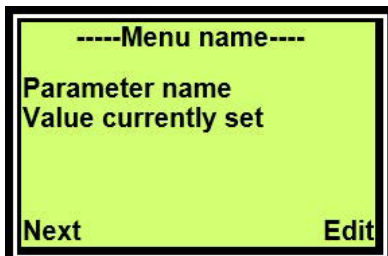

- 1 Select the parameter you want to set in the menu.

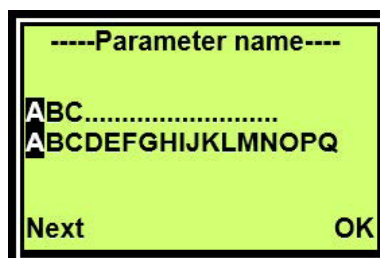

- 2 Press  for parameter editing. The currently selected position is highlighted.



- 3 Press  to select the alphanumeric position to be changed.



- 4 Press  or  to select the required character.
- 5 Press  to select the next position.
- 6 If necessary, select and set other alphanumeric positions using the same procedure as described in steps 3 and 4.
- 7 Press  to confirm your setting

Exiting the setup

Values are mandatory for some menu items. Exit a menu without parameter change as follows:

- 1 Press  repeatedly till the cursor is moved to the right. Once the cursor reaches the end position, “Cancel” is displayed in the lower right.
- 2 Press  to terminate editing and exit the menu item. Or press  to return to the start.

IMPORTANT (NOTE)

The LCD display automatically returns to the process display three minutes after the last button is actuated.

Overview of parameters at the configuration level

IMPORTANT (NOTE)

This overview of parameters shows all the menus and parameters available on the device. Depending on the device version and configuration, some menus and parameters may not be visible.

The displayed menu vary in different operation modes. In this section, menus displayed only in some operation modes are marked with numbers in brackets. The numbers represent the operation modes as follows:

- Level
- Flow
- Volume

Refer to section “Menu levels” for a list of operation modes these numbers represent.

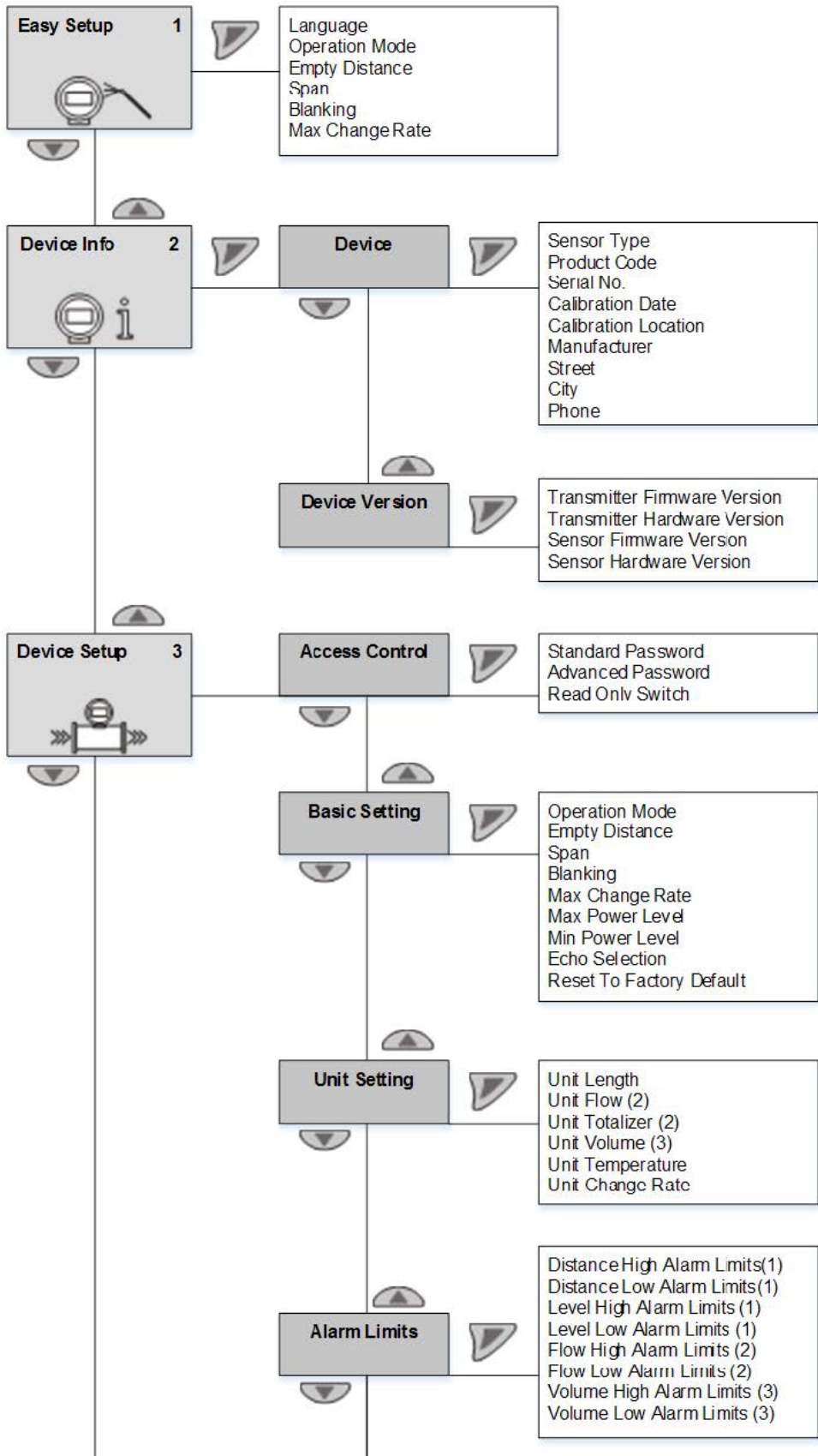

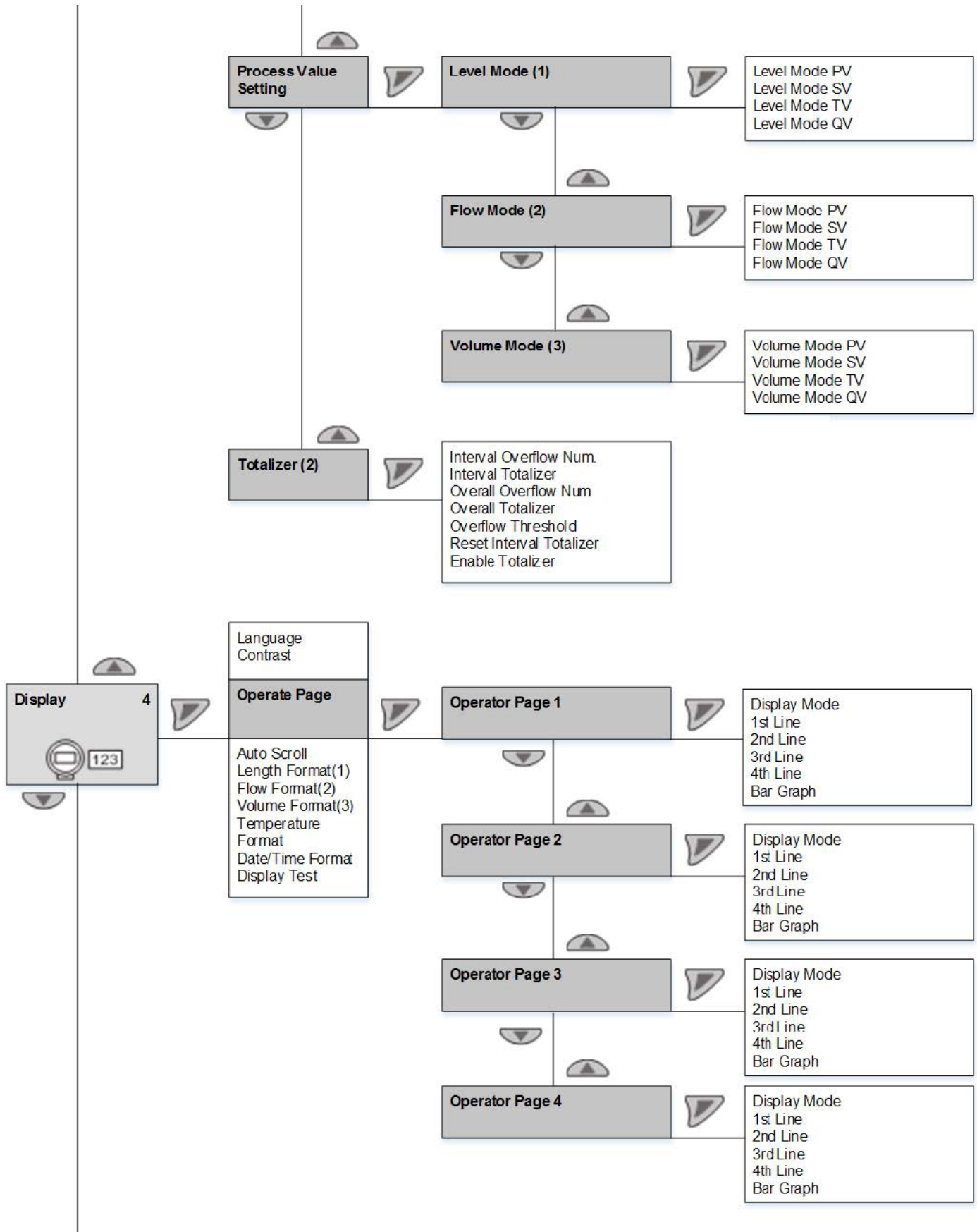

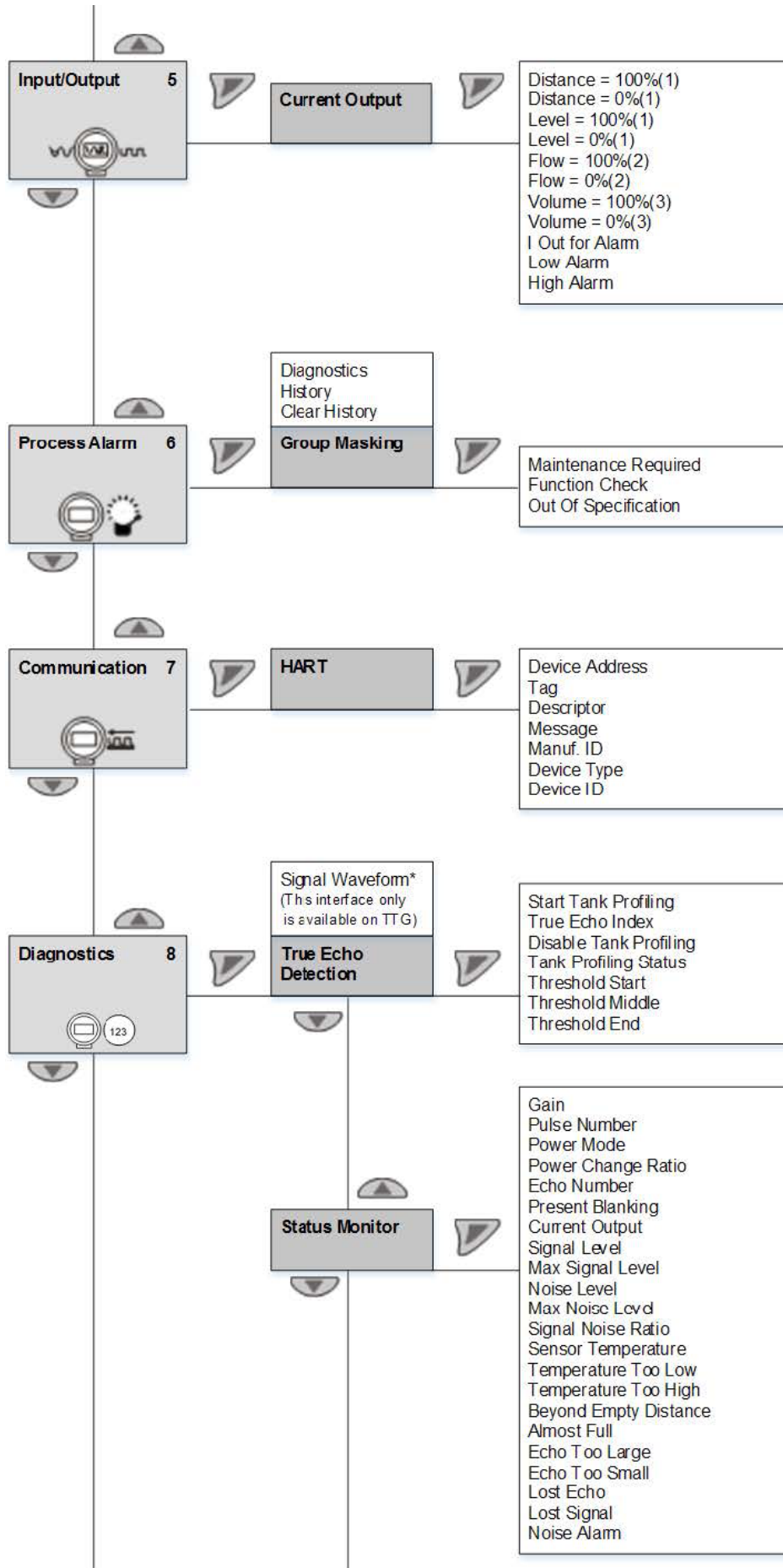

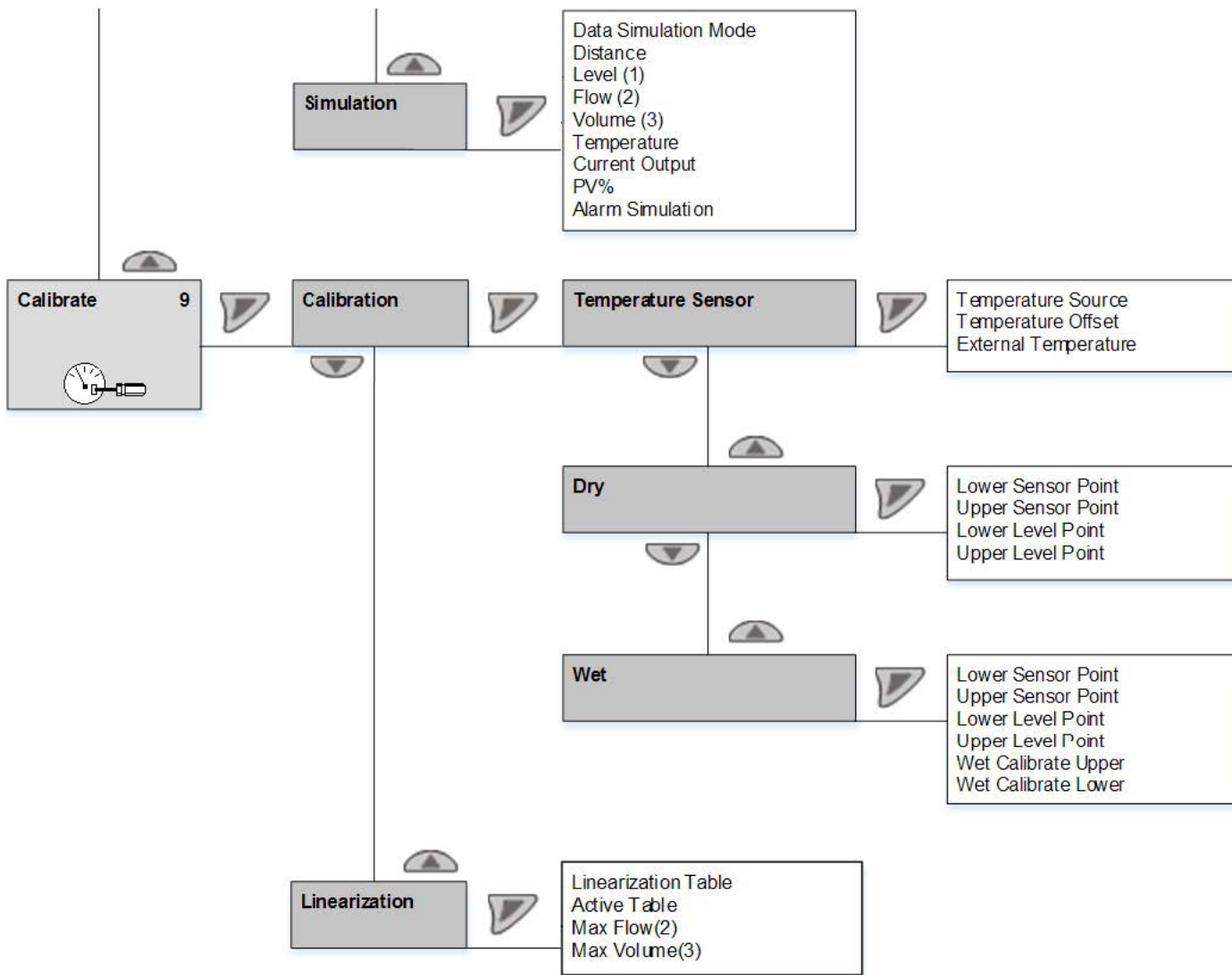

1) Distance Alarm Limit and Level Alarm Limit will be displayed based on present PV in Level Mode.

2) Distance = 100%, Distance = 0% and Level = 100%, Level = 0% will be displayed based on present PV in Level Mode.

Parameter descriptions



Menu: Easy Setup

Menu / Parameter	Value range	Description
Easy Setup		
Language	English, Chinese	Menu language. Only two languages are available. New languages can be downloaded.
Operation Mode	Level Mode Flow Mode Volume Mode	Select an operation mode
Empty Distance	350 to 12000 mm (50 kHz) 250 to 7200 mm (75 kHz)	Distance from sensor to the bottom of the measurement range
Span	0 to 12000 mm (50 kHz) 0 to 7200 mm (75 kHz)	Measurement span
Blanking	350 to 12000 mm (50 kHz) 250 to 7000 mm (75 kHz)	Distance from sensor where no measurement is possible
Max Change Rate	0 to 720 m/h	Maximum rate the level can change

Menu: Device Info

IMPORTANT (NOTE)







This menu is used only to display the device parameters. The parameters are displayed independently of the configured access level, but cannot be changed.

Menu / Parameter	Value range	Description
Device Info		
Device		-
Device Version		-

Menu / Parameter	Value range	Description
Device Info / Device		
Sensor Type	C10 (50 kHz) C06 (75 kHz)	Device sensor frequency
Product Code	-	Product code
Serial No.	-	Product serial number
Calibration Date	-	Product calibration date
Calibration Location	-	Product calibration location
Manufacturer	-	Manufacturer name
Street	-	Manufacturer street name
City	-	Manufacturer city name
Phone	-	Manufacturer phone number

Menu / Parameter	Value range	Description
Device Info / Device Version		
Transmitter Firmware Version	-	Firmware revision of the field device
Transmitter Hardware Version	-	Electronics hardware revision of the field device
Transmitter Bootloader Version	-	Software revision of the electronics board bootloader
Sensor Firmware Version	-	Firmware revision of the sensor
Sensor Hardware Version	-	Electronics hardware revision of the sensor
Sensor Bootloader Version	-	Software revision of the sensor board bootloader

Menu: Device Setup

Menu / Parameter	Value range	Description
Device Setup		
Access Control		-
Basic Setting		-
Unit Setting		-
Alarm Limits		-
Process Value Setting		-
Totalizer		-



Menu / Parameter	Value range	Description
Device Setup / Access Control		
Standard Password	alphanumeric	Set the password for the "Standard" access level
Advanced Password	alphanumeric	Set the password for the "Advanced" access level
Read Only Switch	-	Display the switch settings for hardware write protection

Menu / Parameter	Value range	Description
Device Setup / Basic Setting		
Operation Mode	Level Mode Flow Mode Volume Mode	Select an operation mode
Empty Distance	350 to 12000 mm (50 kHz) 250 to 7200 mm (75 kHz)	Distance from sensor to the bottom of the measurement range
Span	0 to 12000 mm (50 kHz) 0 to 7200 mm (75 kHz)	Measurement span
Blanking	350 to 12000 mm (50 kHz) 250 to 7000 mm (75 kHz)	Distance from sensor where no measurement is possible
Max Change Rate	0 to 720 m/h	Maximum rate the level can change
Max Power Level	1 to 5	Maximum power used
Min Power Level	1 to 5	Minimum power used
Echo Selection	First Echo Largest Echo Average Echo	Echo detection mode
Reset to Factory Default	-	Reset configuration to default according to the present access level

Menu / Parameter	Value range	Description
Device Setup / Unit Setting		
Unit Length	m cm mm feet inch	Define the unit for all length variable (distance, level, head, span, blanking, etc.)
Unit Flow	m ³ /s, m ³ /min, m ³ /h, m ³ /d ft ³ /s, ft ³ /min, ft ³ /h, ft ³ /d L/s, L/min, L/h USGps, USGpm, USGph, USGpd UKGps, UKGpm, UKGph, UKGpd MILGpd	Define the unit for the flow
Unit Totalizer	m ³ ft ³ L USG UKG	Define the unit for the total flow

Menu / Parameter	Value range	Description
Unit Volume	m ³ ft ³ L USG UKG	Define the unit for the volume
Unit Temperature	Kevin Celsius F	Define the unit for the temperature
Unit Change Rate	m/s, m/h inch/min feet/min	Define the unit for the distance change rate

Menu / Parameter	Value range	Description
Device Setup / Alarm Limits		
Distance High Alarm Limits	0 to 12000 mm	Alarm upper limits for distance measurement
Distance Low Alarm Limits	0 to 12000 mm	Alarm lower limits for distance measurement
Level High Alarm Limits	0 to 12000 mm	Alarm upper limits for level measurement
Level Low Alarm Limits	0 to 12000 mm	Alarm lower limits for level measurement
Flow High Alarm Limits	0 to 9999990000.0 m ³ /h	Alarm upper limits for flow measurement
Flow Low Alarm Limits	0 to 9999990000.0 m ³ /h	Alarm lower limits for flow measurement
Volume Low Alarm Limits	0 to 9999990000.0 m ³	Alarm upper limits for volume measurement
Volume Low Alarm Limits	0 to 9999990000.0 m ³	Alarm lower limits for volume measurement

Menu / Parameter	Value range	Description
Device Setup / Process Value		
Level Mode		-
Flow Mode		-
Volume Mode		-
Device Setup / Process Value / Level Mode		
Level Mode PV	Distance Level	Primary variable for level mode
Level Mode SV	Temperature Distance Level	Secondary variable for level mode
Level Mode TV	Temperature Distance Level	Tertiary variable for level mode
Level Mode QV	Temperature Distance Level	Quaternary variable for level mode





Menu / Parameter	Value range	Description
Device Setup / Process Value / Flow Mode		
Flow Mode PV	Flow	Primary variable for flow mode
Flow Mode SV	Temperature Distance Flow Interval totalizer Overall totalizer	Secondary variable for flow mode
Flow Mode TV	Temperature Distance Flow Interval totalizer Overall totalizer	Tertiary variable for flow mode
Flow Mode QV	Temperature Distance Flow Interval totalizer Overall totalizer	Quaternary variable for flow mode

Menu / Parameter	Value range	Description
Device Setup / Process Value / Volume Mode		
Volume Mode PV	Volume	Primary variable for volume mode
Volume Mode SV	Temperature Distance Volume	Secondary variable for volume mode
Volume Mode TV	Temperature Distance Volume	Tertiary variable for volume mode
Volume Mode QV	Temperature Distance Volume	Quaternary variable for volume mode

Menu / Parameter	Value range	Description
Device Setup / Totalizer		
Interval Overflow Num	Read Only	Interval totalizer overflow counter
Interval Totalizer	Display Only	Interval totalizer
Overall Overflow Num	Display Only	Overall totalizer overflow counter
Overall Totalizer	Display Only	Overall totalizer
Overflow Threshold	10E+9 10E+8 10E+7 10E+6 10E+5	Totalizer overflow threshold
Reset Interval Totalizer	-	Reset interval totalizer
Enable Totalizer	-	Enable totalizer

Menu: Display

Menu / Parameter	Value range	Description
Display		
Language	English, Chinese	Menu language. Only two languages are available. New languages can be downloaded.
Contrast	0 to 100	Contrast setting for the LCD display
Operator Pages		
Autoscroll	Disable, Enable	Up to four user-specific operator pages (layouts) can be configured for the process display. If several operator pages have been configured, these can be viewed by manual scrolling. Only Operator Page 1 is enabled by default. When Multiplex mode is enabled, the "Autoscroll" function can be activated at the information level. In this function, operator pages appear on the LCD display at ten-second intervals. Manual scrolling through pre-configured operator pages as described above is no longer necessary. Default setting: Disable
Length Format	0_DP 1_DP 2_DP 3_DP	Select the decimal places for the length indicator Default setting: x.xxx
Flowrate Format	0_DP 1_DP 2_DP 3_DP	Select the decimal places for the flow indicator Default setting: x.x
Volume Format	0_DP 1_DP 2_DP 3_DP	Select the decimal places for the volume indicator Default setting: x.xx
Temperature Format	0_DP 1_DP	Select the decimal places for the temperature indicator Default setting: x.x
Date/Time Format	DD-MM-YYYY MM-DD-YYYY YYYY-MM-YYYY	Select the display format for the date and time Default setting: YYYY-MM-DD
Display Test		Start the test of the LCD display by pressing "OK"

Menu / Parameter	Value range	Description
Display / Operator Pages		
Operator Page 1		-
Operator Page 2		-
Operator Page 3		-
Operator Page 4		-

Menu / Parameter	Value range	Description
Display / Operator Pages / Operator Page 1		
Display Mode	Off 1*6_A 1*6_B 1*6_BAR 1*9 1*9_BAR 2*9 2*9_BAR 3*9 Graph	Configure each operator page
1st Line	MAIN_OPERATOR_VIEW_ SIGNAL_1 MAIN_OPERATOR_VIEW_ SIGNAL_2 MAIN_OPERATOR_VIEW_ SIGNAL_3 ... MAIN_OPERATOR_VIEW_ SIGNAL_20	Configure each line
2nd Line	-	Configure each line
3rd Line	-	Configure each line
4th Line	-	Configure each line
Bar Graph	-	Configure each line
Display / Operator Pages / Operator Page 2/3/4		
Display Mode	-	Configure each operator page
1st Line	-	Configure each line
2nd Line	-	Configure each line
3rd Line	-	Configure each line
4th Line	-	Configure each line
Bar Graph	-	Configure each line

Menu: Input/Output

Menu / Parameter	Value range	Description
Input/Output		
Current Output		-

Menu / Parameter	Value range	Description
Input/Output / Current Output		
Distance I=100%	350 to 12000 mm (50 kHz) 250 to 7200 mm (75 kHz)	In this menu the distance value for which the current output is to indicate its 100 % value (20 mA) is entered. The menu is only displayed when the distance is output at the current output.
Distance I=0%	350 to 12000 mm (50 kHz) 250 to 7200 mm (75 kHz)	In this menu the distance value for which the current output is to indicate its 0 % value (4 mA) is entered. The menu is only displayed when the distance is output at the current output.
Level I=100%	0 to 12000 mm (50 kHz) 0 to 7200 mm (75 kHz)	In this menu the level value for which the current output is to indicate its 100 % value (20 mA) is entered. The menu is only displayed when the level is output at the current output.

Menu / Parameter	Value range	Description
Level I=0%	0 to 12000 mm (50 kHz) 0 to 7200 mm (75 kHz)	In this menu the level value for which the current output is to indicate its 0 % value (4 mA) is entered. The menu is only displayed when the level is output at the current output.
Flow I=100%	0 to 9999990000.0 m ³ /h	In this menu the flow value for which the current output is to indicate its 100 % value (20 mA) is entered. The menu is only displayed when the flow is output at the current output.
Flow I=0%	0 to 9999990000.0 m ³ /h	In this menu the flow value for which the current output is to indicate its 0 % value (4 mA) is entered. The menu is only displayed when the flow is output at the current output.
Volume I=100%	0 to 9999990000.0 m ³	In this menu the volume flowrate value for which the current output is to indicate its 100 % value (20 mA) is entered. The menu is only displayed when the volume flowrate is output at the current output.
Volume I=0%	0 to 9999990000.0 m ³	In this menu the volume flowrate value for which the current output is to indicate its 0 % value (4 mA) is entered. The menu is only displayed when the volume flowrate is output at the current output.
lout for Alarm	Alarm Hi Alarm Low	Select the status of the current output in error condition. The output "low" or "high" current is set in the subsequent menu. Default setting: "Low Alarm" General Alarm is not configurable.
Low Alarm	Max 3.6000 Min 3.5000	Unit: mA Select the current for Low Alarm
High Alarm	Max 22.600 Min 21.000	Unit: mA Select the current for High Alarm

Menu: Process Alarm

Menu / Parameter	Value range	Description
Process Alarm		
Diagnostic History	-	Display of the alarm history
Clear History	Execute	Clear the alarm list
Group Masking		Alarm messages are divided into groups. If masking is activated for a group (ON), no alarm occurs.

Menu / Parameter	Value range	Description
Process Alarm / Group Masking		
Maintenance Required	Disable, Enable	-
Function Check	Disable, Enable	-
Out Of Specification	Disable, Enable	-

Menu: Communication

Menu / Parameter	Value range	Description
Communication		
HART		-

Menu / Parameter	Value range	Description
Communication / HART		
Device Address	Max 15 Min 0	Select the HART device address. The HART protocol has provisions for creating a bus with up to 15 devices (1 to 15). If an address greater than 0 is set, the device operates in Multidrop mode, i.e., the current output is fixed at 4 mA and there is only HARTcommunication over the current output.
Tag	8 characters, uppercase only, no special characters	Enter a HART TAG number as the unique identifier for the device
Descriptor	16 characters, uppercase only, no special characters	Enter a HART descriptor
Message	32 characters alphanumeric	Display of the alphanumeric TAG number
Manuf. ID	26.000	Display of the HART manufacturer ID ABB = 26







Menu / Parameter	Value range	Description
Device Type	161.00	Display of the HART device type LST300 = 161
Device ID	1.0000	Display of the HART device ID

Menu: Diagnostics

Menu / Parameter	Value range	Description
Diagnostics		
Signal Waveform	-	-
True Echo Detection		-
Status Monitor		-
Simulation		-
Device Run Time		-
Diagnostics / True Echo Detection		
Start Tank Profiling	-	Start tank profiling
Select True Echo	1 to 5	Select true echo number
Disable Tank Profiling	-	Disable tank profiling
Tank Profiling Status	Idle Initialize Pulsing Processing Finish	Present tank profiling status
Threshold Start	Max 2500.0 mV Min 0.0000 mV	The voltage of the threshold at the first threshold point. This point is where the blanking distance ends.
Threshold Middle	Max 2500.0 mV Min 0.0000 mV	The voltage of the threshold at the middle threshold point
Threshold End	Max 2500.0 mV Min 0.0000 mV	The voltage of the threshold at the last threshold point. This point is at the Empty Distance.
Diagnostics / Status Monitor		
Gain	Display only	The Gain value of the sensor in the last measurement
Pulse Number	Display only	The Number of pulses of the sensor in the last measurement
Power Mode	Display only	The Power Mode of the sensor in the last measurement
Power Change Ratio	Display only	The number of power changes in the last minute
Echo Number	Display only	The number of echoes in the last measurement
Present Blanking	Display only	Present blanking value
Current Output	Display only	The analog output in mA
Signal Level	Display only	Average size in mV of all echoes that crossed the threshold in the last measurement
Max Signal Level	Display only	Maximum signal level in mV in the last measurement
Noise Level	Display only	Average size in mV of all echoes that did not cross the threshold in the last measurement
Max Noise Level	Display only	Maximum noise level in mV in the last measurement
Signal Noise Ratio	Display only	Ratio of signal to noise
Sensor Temperature	Display only	The temperature as measured by the internal temperature sensor
Temperature Too Low	Display only	Alarm for temperature too low
Temperature Too High	Display only	Alarm for temperature too high
Beyond Empty Distance	Display only	Alarm for distance beyond empty distance
Almost Full	Display only	Alarm for distance close to blanking
Echo Too large	Display only	Alarm for echo too large
Echo Too Small	Display only	Alarm for echo too small
Lost Echo	Display only	Alarm for single echo lost
Lost Signal	Display only	Alarm for echo lost
Noise Alarm	Display only	Alarm for noise

Menu / Parameter	Value range	Description
Diagnostics / Simulation		
Data Simulation Mode	Simulation off Distance sim Temperature sim Level sim Volume sim Flow sim PV% sim Current out sim	Select data simulation mode
Distance	0 to 12000 mm	Distance in simulation
Level	1000 to 12000 mm	Level in simulation
Flow	0 to 9999990000.0 m ³ /h	Flow in simulation
Volume	0 to 9999990000.0 m ³	Volume in simulation
Temperature	-100 to 100 °C	Temperature in simulation
Current Output	3.5 to 22.6 mA	Current in simulation
PV%	0 to 100	PV% in simulation
Alarm Simulation	See section "Alarm Simulation"	-
Diagnostics / Device Run Time		
Interval Run Time	Display only	Device interval run time in second
Total Run Time	Display only	Device total run time in second
Reset Interval Time	Display only	Reset device interval run time
Maintenance Time	Display only	Remaining maintenance time in day

Menu: Calibrate

Menu / Parameter	Value range	Description
Calibrate		
Calibration		-
Linearization		-
Calibrate / Calibration		
Temperature Sensor		-
Ultrasonic sensor		-
Dry		-
Wet		-
Calibrate / Calibration / Temperature Sensor		
Temperature Sensor	Default Temp (20 °C) Inner Temp External Temp	Temperature source selection
Temperature Offset	-100 to 100 °C	Temperature offset
External Temperature	-100 to 100 °C	External temperature
Calibrate / Calibration / Dry		
Lower Sensor Point	0 to 12000 mm	Lower sensor point for level calibration
Upper Sensor Point	0 to 12000 mm	Upper sensor point for level calibration
Lower Level Point	0 to 12000 mm	Lower level point for level calibration
Upper Level Point	0 to 12000 mm	Upper level point for level calibration

Menu / Parameter	Value range	Description
Calibrate / Calibration / Dry		
Lower Sensor Point	0 to 12000 mm	Lower sensor point for level calibration
Upper Sensor Point	0 to 12000 mm	Upper sensor point for level calibration
Lower Level Point	0 to 12000 mm	Lower level point for level calibration
Upper Level Point	0 to 12000 mm	Upper level point for level calibration
Calibrate / Calibration / Wet		
Lower Sensor Point	Display Only	Result lower sensor point for level calibration
Upper Sensor Point	Display Only	Result upper sensor point for level calibration
Lower Level Point	0 to 12000 mm	Lower level point for level calibration
Upper Level Point	0 to 12000 mm	Upper level point for level calibration
Wet Calibrate Lower	-	Wet calibrate lower sensor point
Wet Calibrate Upper	-	Wet calibrate upper sensor point
Calibrate / Linearization		
Linearization Table	-	Linearization Table configuration interface
Active Table	Disable, Enable	Enable or disable the linearization table
Max Flow	0 to 9999990000.0 m ³ /h	The maximum flow value of the channel
Max Volume	0 to 9999990000.0 m ³	The maximum volume of the vessel

Menu: Service

Refer to the service manual for more details.

Alarm Simulation

Device with HART protocol

Software SWxxxxxxx		
Software version	Type of changes	Operating instructions
00.00.01	Original	OI/LST300-EN Rev. B

7 Advanced functions

Signal waveform

The signal waveform function is used to analyze the process conditions, optimize installation and visualize false echoes for further processing. The signal waveform is available on the Through The Glass (TTG) version of LST300, but can also be accessed via Enhanced Device Description (EDD) on handheld configurators such as ABB DHH800, or on a computer using the Device Type Manager (DTM).

In the instructions below, the signal waveform on the LST300 HMI interface is shown as an example.

Accessing the waveform display

- 1 Log on to the LST300 at the **Standard** or **Advanced** level.



- 2 Select **Diagnostics** from the main menu.

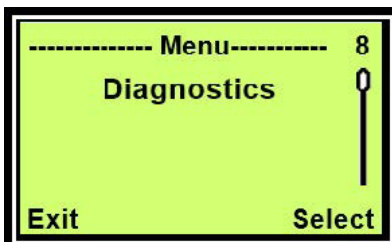

- 3 Select **Waveform** from the "Diagnostics" submenu.

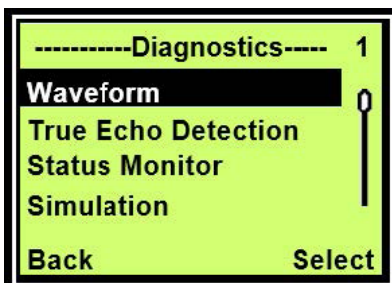

Signal waveform display

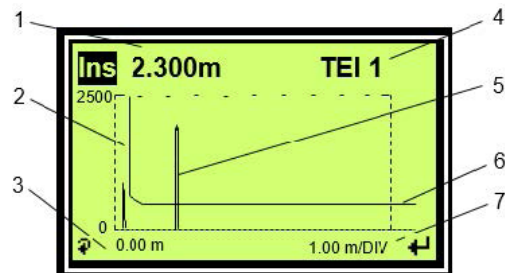

Figure 26 Signal waveform display (example)

1	Current process values
2	Blanking distance line — All signals to the left of this line are ignored
3	Waveform x-axis offset — Used to scroll along the axis when zoomed
4	True Echo Index — Indicates which echo is used when True Echo Detection is used
5	Echo signal example
6	Threshold — All signals below this line are ignored and considered noise
7	Waveform zoom level — Used to see more details.

The signal waveform can be selected from the "Diagnostics" menu. It shows information about the last measured signal and the current process values. The zoom function allows access to more details in a specific region.

Description of symbols



Symbol	Description
	Return to the "Diagnostics" menu
	Scroll to the next parameter
	Enter the True Echo Index selection menu

Selecting parameters to display

In the signal waveform display, select the live information to display as follows:

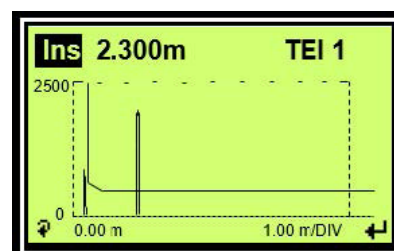
- 1 Press to switch until the current process values box in the top left is highlighted.



- Press  or  to scroll through the different process values.



Area	Description
Ins	The instant distance measured during the last measurement. This corresponds to the distance of the echo shown in the waveform.
Tem	The measured process temperature.
Sig	The size of the echo as shown in the waveform (in mV)

Selecting True Echo Index (TEI)

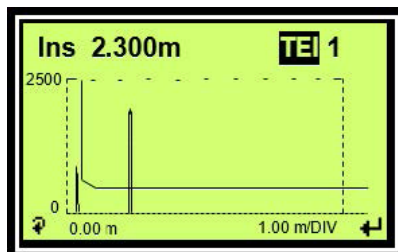

The True Echo Index is used together with the True Echo Detection function. Information on applying this function is shown in Section of this document.

- Press  to switch until the current process values box in the top left is highlighted.

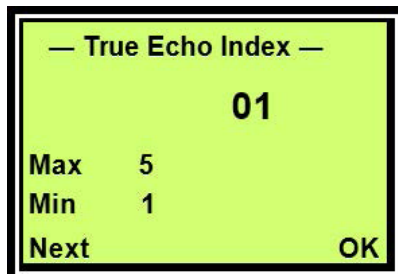

- Press  to enter the "True Echo Index" menu.
- Press  to select the position to be changed.





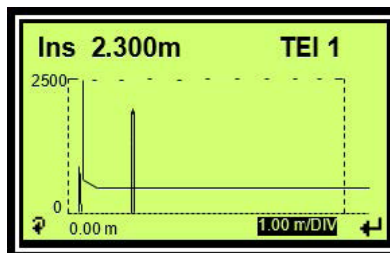

- Press  or  to scroll through the different process values.
- Press  to confirm your selection.

Changing waveform zoom

- Press  to switch until the waveform zoom level box in the bottom right is highlighted.



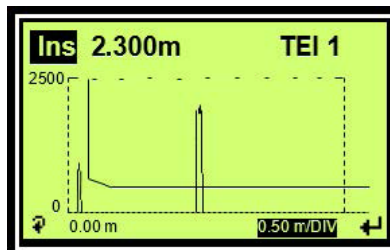

- Press  to zoom in and view more details.
- Press  to zoom out to have a wider view of the measurement range.
- After zooming in, press  or  to scroll back to the original or other zoom view levels.

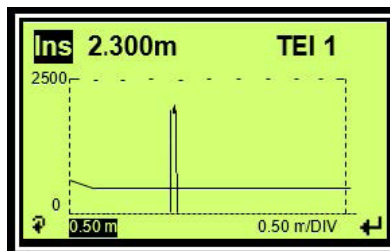

Scrolling the x-axis

- When zoomed in, press  to switch until the waveform x-axis offset box in the bottom left is highlighted.



- Press  to scroll to the right to be further from the sensor and closer to the maximum measurement range.
- Press  to scroll to the left to be closer to the sensor and further from the maximum measurement range.

True Echo Detection

Accessing the True Echo Detection menu

- 1 Log on to the LST300 at the **Standard** or **Advanced** level.



- 2 Select **Diagnostics** from the main menu.

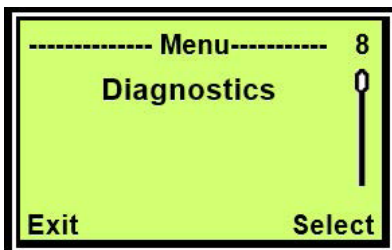

- 3 Select **True Echo Detection** from the “Diagnostics” submenu.

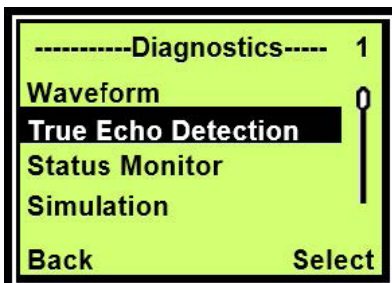

Configuring True Echo Detection

- 1 Install LST300 following the instructions in chapter 2 “Mounting”. Avoid as many obstructions as possible and ensure the transmitter has clear line of sight to the target liquid surface.

IMPORTANT (NOTE)

The best way to ensure the correct echo is measured is a good installation with clear line of sight. The True Echo Filtering function is used optimally when obstructions cannot easily be avoided, such as submerged pumps and agitators.

- 2 Ensure the tank is empty enough for all obstructions to be visible. Any obstructions that are submerged cannot be detected.

- 3 Navigate to the “True Echo Detection” menu, as explained in section “Accessing the True Echo Detection menu”.



- 4 Select **Start Tank Profiling** from the “True Echo Detection” submenu.

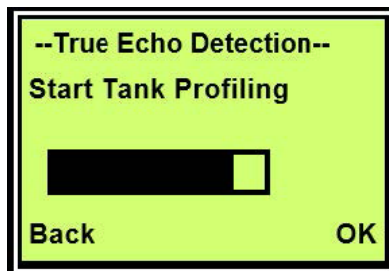

- 5 Select **OK** to start Tank Profiling.

IMPORTANT (NOTE)

Tank profiling may take up to 2 minutes to complete. During this time no measurement values are used as output.

- 6 After two minutes, select **Tank Profiling Status** to check whether the Tank Profiling is complete. The status should be *Finish*.



- 7 Navigate to the signal waveform display as explained in section “Accessing the waveform display”.

IMPORTANT (NOTE)

It is assumed in the following steps that the signal waveform display is used.

If the signal waveform display is not available, the same function can be performed by checking the process display window to verify the measurement, and changing the True Echo Index as shown in section “Selecting the True Echo Index (TEI)”.

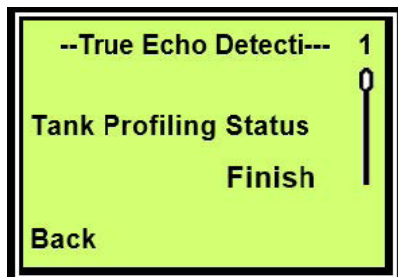

8 In the waveform display, check whether the result of Tank Profiling is as expected. In this example **Echo 3** is selected and the Instant Distance is **6.250 m**. If this is the correct target, no further setup is required.

IMPORTANT (NOTE)

Some echoes may appear small, but can cause false measurements under certain conditions. LST300 compensates for all possible conditions, and therefore may create false echo windows when it does not look necessary in the current measurement.

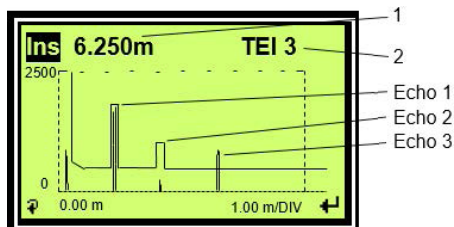

- 1. Ins 6.250m: Shows Instant Distance of the selected echo is 6.250 m
- 2. TEI 3: shows echo number 3 is selected as the true echo

9 As an example, Echo number 2 is assumed as the desired echo in this step. Follow the steps in section “Selecting the True Echo Index (TEI)” to change the True Echo Index to 2.

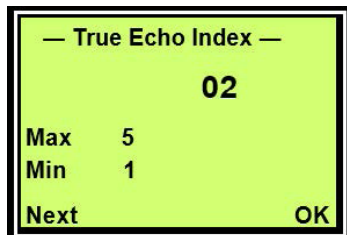

10 Check whether the result is as expected. The Instant Distance is shown as **4.100 m** in this example.

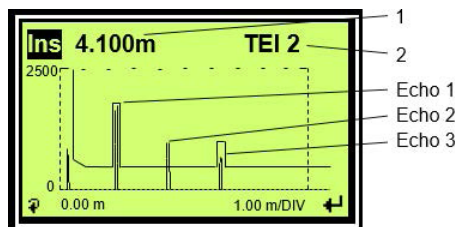

- 1. Ins 4.100m: Shows Instant Distance of the selected echo is 6.250 m
- 2. TEI 2: shows echo number 2 is selected as the true echo

11 To disable the True Echo Detection function, select **Disable Echo Detection** from the “True Echo Detection” menu and click **OK**.

IMPORTANT (NOTE)

Tank profiling data is lost when the Tank Profiling function is disabled.

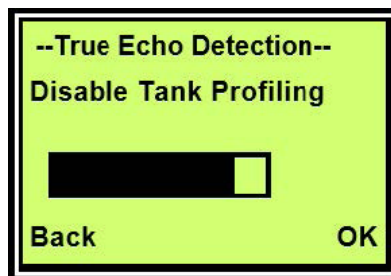

Volume

Volume output is used in situations where a volume output is desired, instead of the level. LST300 has 32 points allowing the operator to plot a volume to level chart. This chart is usually provided by the tank manufacturer. It is also possible to calculate custom tank volumes using dimensions from drawings.

Common tank shapes include:

- Flat base tanks
- Cone base tanks
- Half sphere base tanks
- Sloped base tanks
- Horizontal cylinder tanks
- Tanks with angles between sections

Example tank

In this example, a cylindrical tank with a cone base is configured. This is a simple shape to configure, containing only 3 points and linear sections in between.

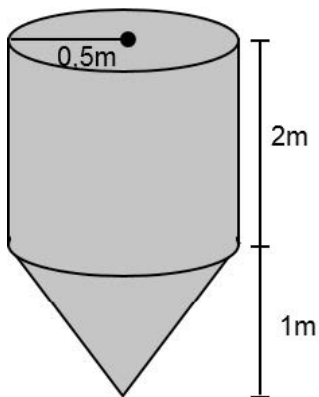

Figure 27 Cylindrical tank with cone base

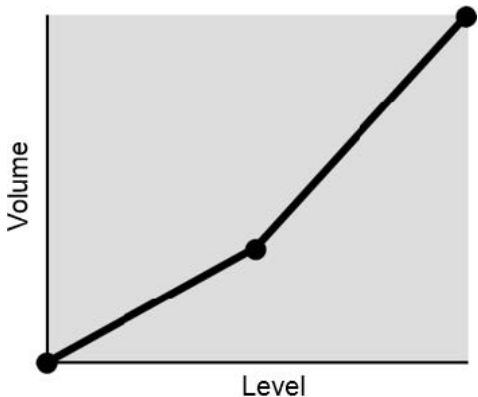

Figure 28 Linearization curve of cylindrical tanks with cone base

Configure the level settings

1 Log on to the LST300 at the **Standard** or **Advanced** level.



2 Select **Easy Setup** from the main menu.



3 Select **Volume** as the **Operate Mode** and then press **Next**.

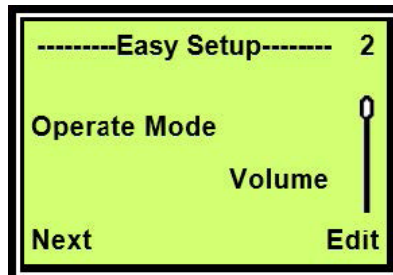

4 Select **Empty Distance** to configure the distance from the face of the sensor to the bottom of the tank.

In Level mode, Empty Distance indicates the tank is empty. In this example the sensor is assumed as 0.25 m above the top of the tank.

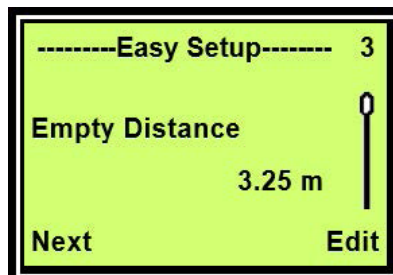

5 Press **Next** to confirm the Empty Distance configuration.

6 Configure **Span** to configure the distance from the bottom of the tank to the top of the tank.

In Level mode, Span indicates the tank full position. This is the 3.00 m as shown in figure 22 "Cylindrical tank with cone base".



7 Press **Next**. to confirm the Span configuration.

Configure the volume unit

- 1 Select **Calibrate** from the main menu.

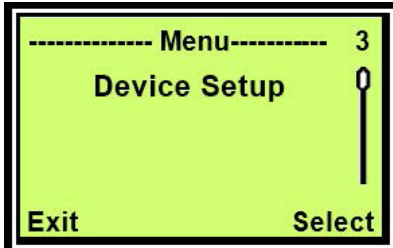

- 2 Select **Units Config** from the “Diagnostics” submenu.



- 3 Select **Volume Unit** from the “Unit Config” submenu.

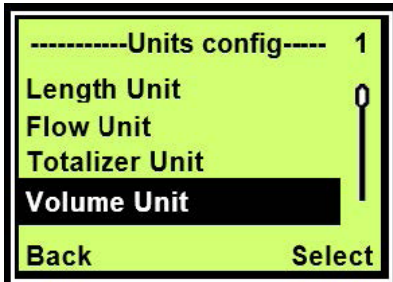

- 4 Configure the **Volume Unit** as required (liter is used in this example) and then press **Next**.

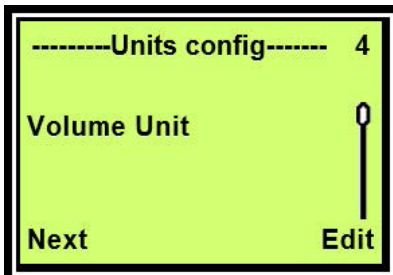

Configure the linearization table

- 1 Select **Calibrate** from the main menu.

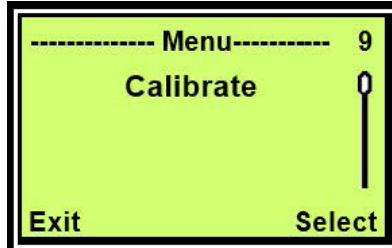

- 2 Select **Linearization** from the “Calibrate” submenu.

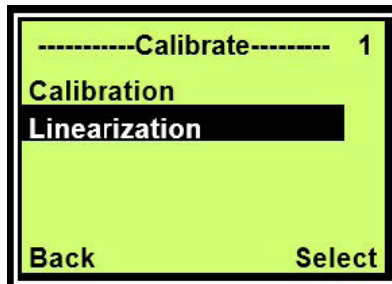

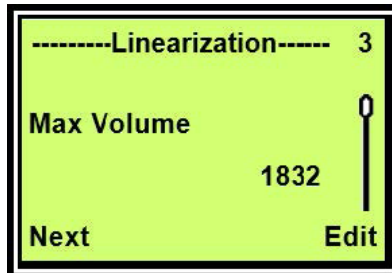

- 3 Set **Max Volume** from the “Linearization” submenu.

In this example, 1832 liters is set as the maximum volume (unit already set in section “Configuring the volume unit”).

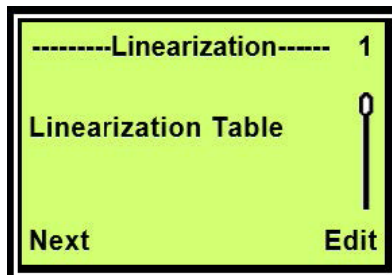

- 4 Enter the **Linearization Table** from the “Linearization” submenu.



- 5 Press  to select the position to be changed to the linearization point number. The first point to update in this example is point 00.

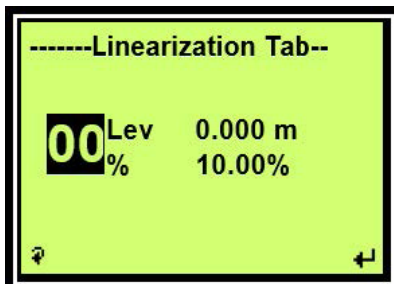

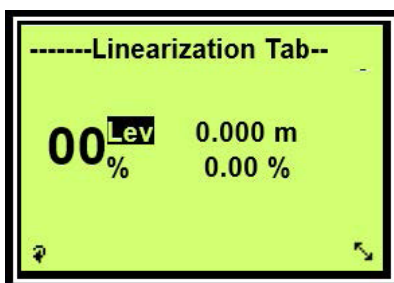

- 6 Press  to change the position to Lev.

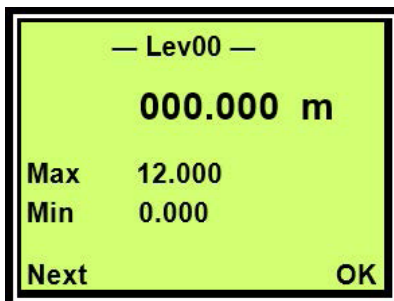

- 7 Use  to enter the editing menu.
- 8 Set the level for point 00 in the editing menu.
In this example level 0.000 m is set.



- 9 Use  to select OK and return to the “Linearization Table” menu.
- 10 Press  to change the position to % for point 00.

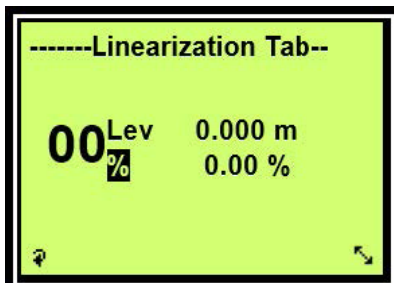

- 11 Use  to enter the editing menu.

- 12 Set the level for point 00 in the editing menu.
In this example a percentage of 0% is set for point 00.

- 13 Use  to select OK and return to the “Linearization Table” menu.

- 14 Repeat steps 5 to 13 for linearization point 01 and 02 according to the data in the table below:

Point	Level	%
00	0.000 m	0.00 %
01	1.000 m	14.30 %
S02	3.000 m	100 %

Open channel flow

The LST300 open channel flow function calculates the flowrate in an open channel by measuring level and converting it to a flowrate using standard equations. The automated calculation of parameters can only be done using DTM or EDD. Alternatively the calculation can be done offline, and the setup can be done in the field on the HMI using the pre-calculated maximum flow value and linearization table.

The open channel flow is not calculated directly. A linearization table and the maximum flowrate are calculated and downloaded to the device using DTM or EDD. Then this linearization table is used on the device to calculate the flowrate.

LST300 supports the following 12 channels:

- Rectangular thin plate weir
- Triangular notch thin plate weir
- Rectangular broad crested weir
- Rectangular throated flume
- Trapezoidal throated flume
- U throated flume
- Round nose horizontal broad crested weir
- Parshall flume
- Palmer bowlus flume
- Round pipe
- Leopold lagco flume
- Cut throat flume

Any custom or special channels with available linearization transfer curve can also be configured manually.

Open channel flow on DTM

1 Click **Configuration > Device Setup > Basic Setting**.

Basic Setting

Operate Mode: Flow [Set]

Empty Distance: 10.000 m

Span: 9.650 m

Blanking: 0.350 m

Max Change Rate: 600.000 m/h [Set]

Max Power Level: 5

Min Power Level: 1

Echo Selection: First Echo

2 Select *Flow* in the **Operate Mode** field and click **Set**.

5 The parameters and an image for the selected channel shape are displayed.

Open Channel Selection

Channel Shape: Triangular Notch Thin Plate Weir

Flow Calculation

Maximum Flowrate (Q_{max}): 5043.992 m³/h

Triangular-notch thin-plate weir

Notch Angle (20-100 degrees) (α): 20 deg

Span: 2 m

Generate [Calculate]

Diagram: A cross-sectional view of a triangular notch weir. The notch angle is labeled as α . The water level is shown as a blue triangle above the notch. The weir structure is shown in grey, and the channel bed is shown in brown with small stones.

6 Complete the parameters and click **Calculate**.

7 The maximum flowrate is calculated and displayed at the top of the interface.

Note

The max flowrate calculation must be executed before the linearization table generation, to prevent an incorrect linearization table.

3 Click **Configuration > Open Channel Flow > Open Channel Selection**.

Open Channel Selection

Channel Shape: Customer Curve

UserCurve

Options: U Flume, Round Nose, Parshall Flume, Palmer Bowlius Flume, Round Pipe, Leopold Lagco Flume, Cut Throat Flume, Customer Curve

Graph: A small graph showing a percentage (%) on the y-axis with values 1 and 1.2. The x-axis is unlabeled.

4 Select a value from the **Channel Shape** box and click **Apply**. The *Triangular Notch Thin Plate Weir* is selected here as an example.

8 Click **Generate** to generate the linearization table for this channel shape.

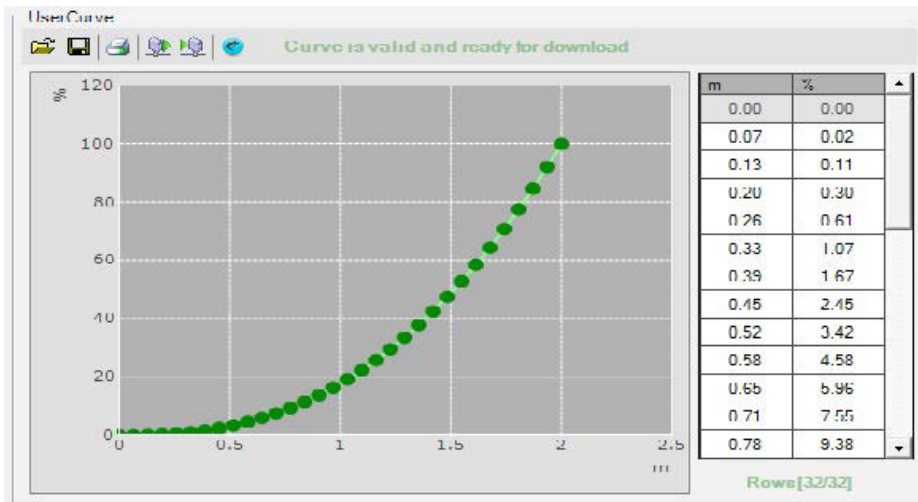

9 The linearization table is displayed below.

10 Click **Store user curve to device**  to store the linearization table to the device.

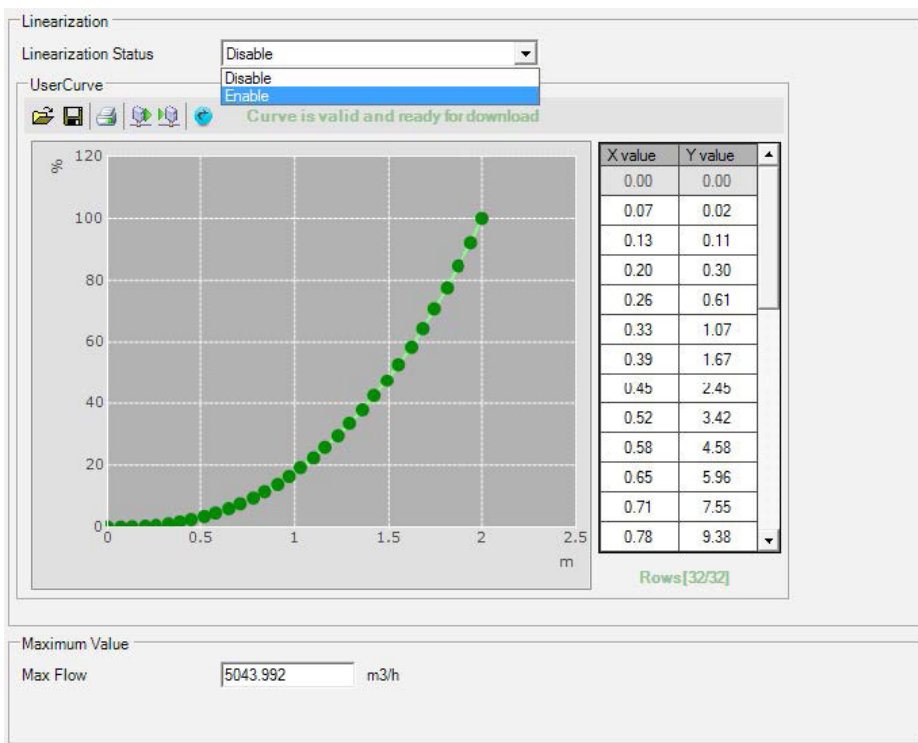

11 Click **Calibration > Linearization > Linearization** to confirm the setting.

12 Click **Load user curve from device** and select *Enable* in the **Linearization Status** field to active the open channel flow function.

Open channel flow on EDD

- 1 Click **Configuration > Device Setup > Basic Setting**.

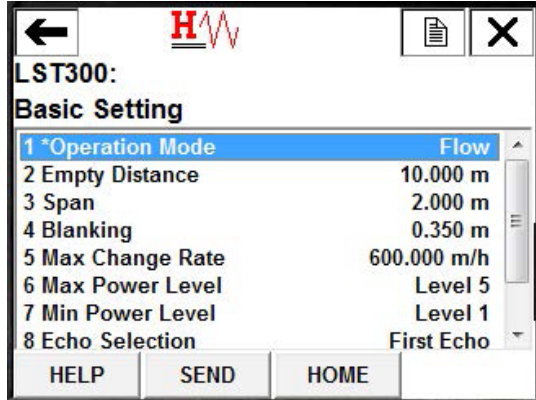

- 2 Select **Flow** in the **Operate Mode** field and click **SEND**.
- 3 Click **Configuration > Open Channel Flow**.
- 4 Select a value from the **Channel Shape** box and click **SEND**.
The *Triangular Notch Thin Plate Weir* is selected here as an example.

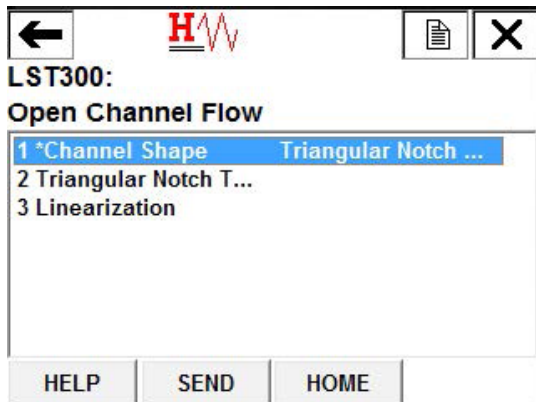

- 5 The parameters and an image for this channel shape are displayed.
- 6 Edit the parameters and click **Calculate Max Flowrate**.

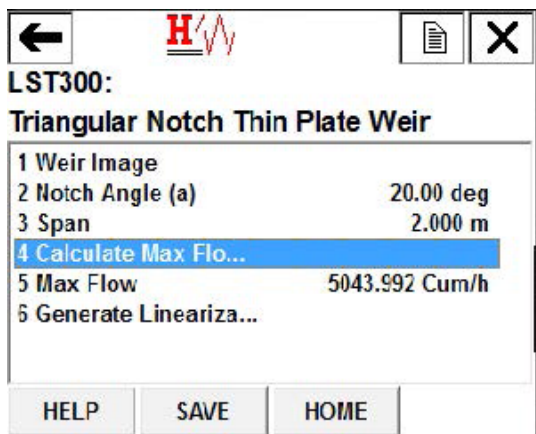

- 7 The maximum flowrate is calculated and displayed. The maximum flowrate is downloaded to device automatically.

Note

The max flowrate calculation must be executed before the linearization table generation, to prevent an incorrect linearization table.

- 8 Click **Generate Linearization Table** to generate the linearization table for this channel shape.



- 9 Click **Configuration > Open Channel Flow > Linearization** to confirm the linearization.

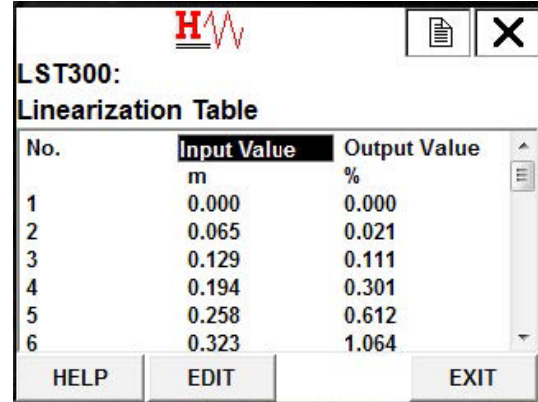

Calibration

An easy-to-use calibration enables the best possible accuracy by calibrating the measurement to two known good points.

Ultrasonic level calibration

There are two types of errors: offset and gradient.

Offset error

The error at a close range is equal to the error at maximum range. In this case the c value in the equation $y=mx+c$ must be corrected.

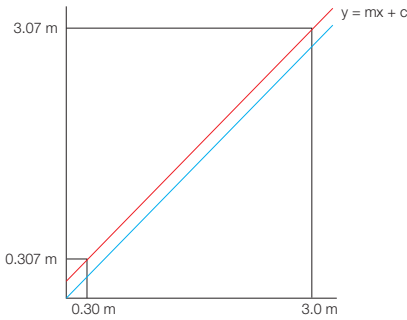

Gradient error

A small error at a close range becomes larger as the range increases. In this case the m value in the equation $y=mx+c$ must be corrected.

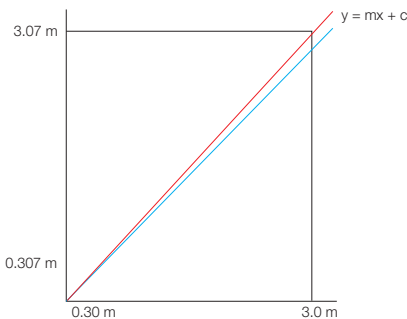

The speed of sound is linear, enabling calibration to be performed using only two known points. This provides sufficient information to calibrate LST300.

Calibration can be performed in position if the tank dimensions are known. This gives best results as it ensures the instrument is calibrated to the intended installation. Alternatively, the calibration can be performed before installation by pointing the sensor at a known target.

There are two kinds of calibration for LST300. One is for wet calibration and the other is for dry calibration.

Dry calibration

Dry calibration can be done when we have two known target levels available, and have the actual measurements at those known points from LST300.

Before starting the calibration procedure, gather the required measurements that will be used as inputs to the dry calibration function.

Parameter	Description
Lower Sensor Point	LST300 measurement for the level position closest to the bottom of the tank
Upper Sensor Point	LST300 measurement for the level position closest to the top of the tank
Lower Level Point	The expected level value at the level position closest to the bottom of the tank
Upper Level Point	The expected level value at the level position closest to the top of the tank

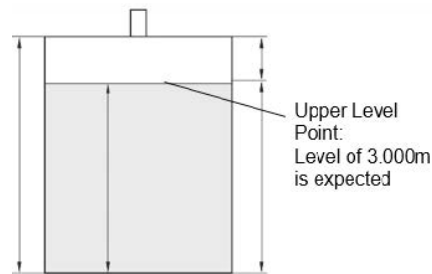
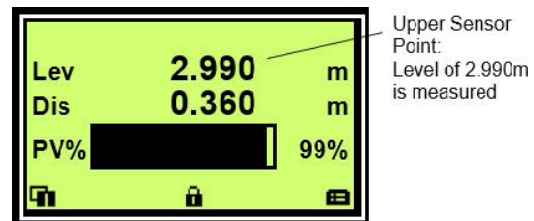

Figure 29 Upper calibration point measured

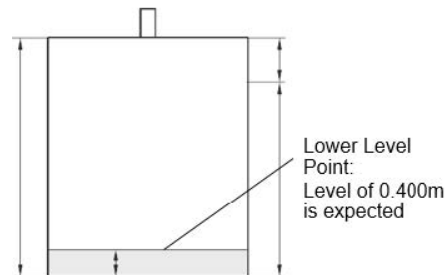
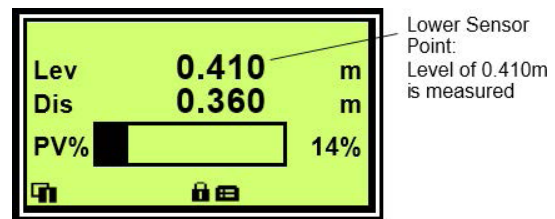

Figure 30 Lower calibration point measured

As shown in the above figures, values in the following table are used as an example.

Parameter	Value
Lower Sensor Point	0.410 m is measured
Upper Sensor Point	2.990 m is measured
Lower Level Point	0.400 m is expected
Upper Level Point	3.000 m is expected

Dry calibration procedure

1 Log on to the LST300 at the **Standard** or **Advanced** level.



2 Select **Calibrate** from the main menu.

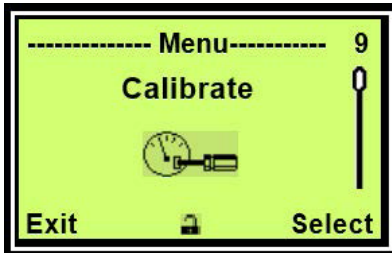

3 Select **Calibration** from the “Calibrate” submenu.

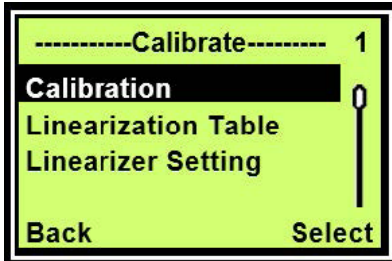

4 Select **Dry** from the “Calibration” submenu.

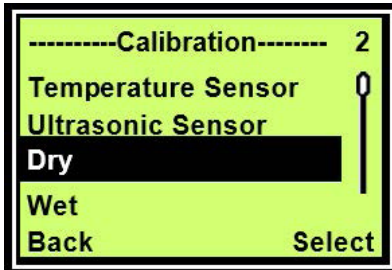

5 Configure the four parameters in this menu using the data already obtained earlier in section “Dry calibration”.
The level dry calibration is immediately active on the LST300.

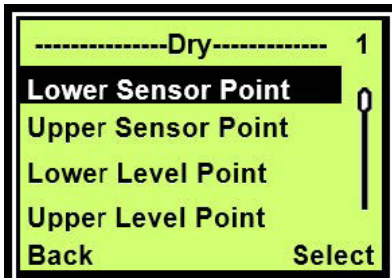

Wet calibration

Wet calibration can be done in position, and the measurement is performed directly from the calibration menu. No measurement is required prior to calibration. It is however required that the level can be adjusted to the calibration positions while performing the calibration.

Wet calibration procedure

- 1 Follow the steps 1 to 3 in section “Dry calibration procedure” to navigate to the “Calibration” submenu.
- 2 Select **Wet** from the “Calibration” submenu.

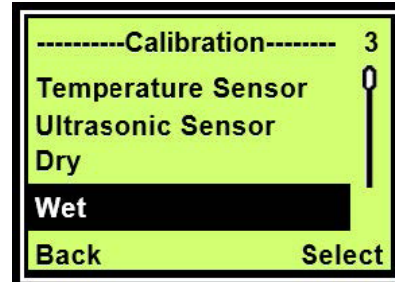

3 Ensure the LST300 is measuring the upper calibration point, by ensuring the conditions as indicated in figure 26 “Upper calibration point measured”.

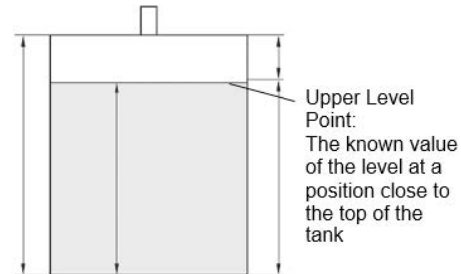
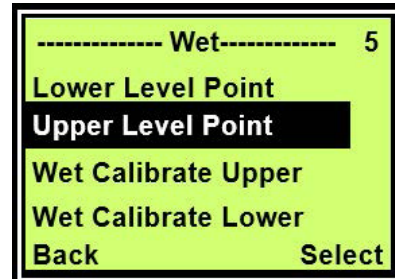
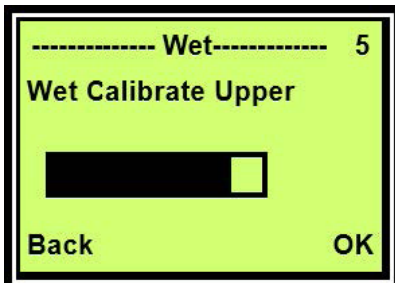

Figure 31 Upper calibration point measured

4 Configure the **Upper Level Point** as the known value of the level at a position close to the top of the tank.



- 5 Select **Wet Calibrate Upper** to perform a sensor measurement of the upper calibration point, and then click **OK**



- 6 Confirm the measurement in the **Upper Sensor Point** set.

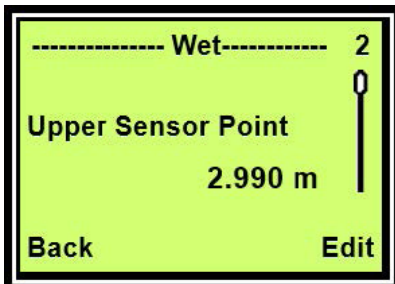

- 7 Ensure the LST300 is measuring the lower calibration point, by ensuring the conditions as indicated in figure 27 “Lower calibration point measured”.

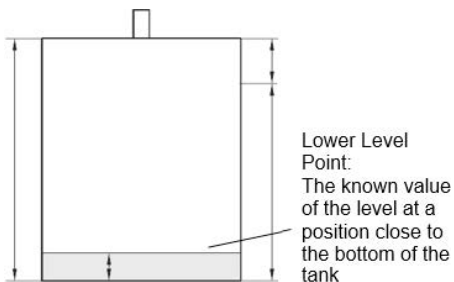
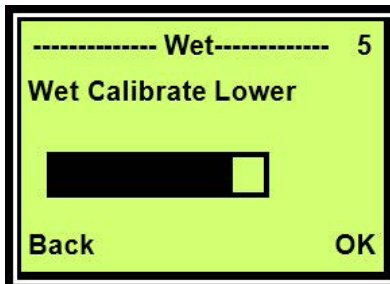
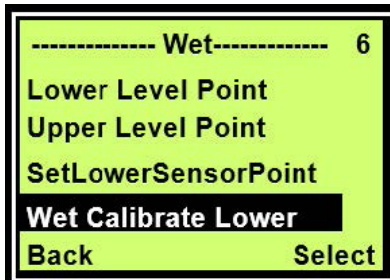
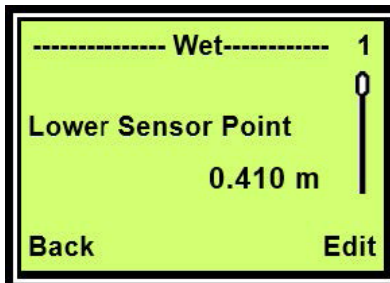

Figure 32 Lower calibration point measured
Lower Level Point: The actual short range level

- 8 Select **Wet Calibrate Lower** to perform a sensor measurement of the lower calibration point, and then click **OK**.



- 9 Confirm the measurement in the **Lower Sensor Point** set. The level wet calibration is immediately active on the LST300.



8 Diagnostic messages

The LST300 provides several diagnostic messages that can be viewed from the menu. The diagnostic messages provide insight into the state of the current process and is valuable for application troubleshooting.

Table 3 details each diagnostic message together with possible causes and remedial actions.

Error no. / Range	Text on the LCD display	Cause	Remedy / Spare part
F104.004 Process	Primary variable exceeds limit Confirm process variable limits	Primary variable exceeds limit	Confirm the process variable and take action for limit exceeding.
F105.010 Process	Primary Variable is exceeds range Confirm Primary Variable range	Primary variable exceeds range	Confirm Primary Variable and take action for range exceeding.
F113.016 Electronics	Sensor board failure Restart device. If failure, contact ABB service	Sensor board failure	Re-start the device. If this fails to solve the problem, contact ABB Level Support at http://www.abb.com/ level.
C117.017 Electronics	Sensor board write memory error. Restart device. If failure, contact ABB service	Sensor board write memory failure	Re-start the device. If this fails to solve the problem, contact ABB Level Support at http://www.abb.com/ level.
C118.023 Electronics	Electronics board write memory error. Restart device. If failure, contact ABB service	Electronics board write memory failure	Re-start the device. If this fails to solve the problem, contact ABB Level Support at http://www.abb.com/ level.
M024.031 Operation	Incorrect voltage for device Check power supply	Incorrect voltage for proper device operation	Check power supply.
S022.032 Process	Environment temperature exceed Measurement may be invalid. Check temperature	Environmental conditions exceed acceptable device operating conditions	Measurement reading may be invalid. Rectify improper environmental conditions.
C098.035 Configuration	Measurement data simulate Confirm device should be in simulation mode	One or more measurement values are in simulation mode	Confirm measurement values should be in simulation mode.
F106.038 Electronics	Current output circuit failure Restart device. If failure, contact ABB service	Current output circuit has failed	Re-start the device. If this fails to solve the problem, replace the electronics board.
F121.039 Electronics	Electronics board failure Restart device. If failure, contact ABB service	Electronics board failure	Re-start the device. If this fails to solve the problem, contact ABB Level Support at http://www.abb.com/ level.
F116.040 Process	Sensor initialized data get error Restart device. If failure, contact ABB service	Sensor board configuration data cannot got.	Re-start the device. If this fails to solve the problem, contact ABB Level Support at http://www.abb.com/ level.
M020.041 Operation	NV replace error Restart device. If failure, contact ABB service	An error occurred during a NV Replace effort	Re-start the device. If this fails to solve the problem, contact ABB Level Support at http://www.abb.com/ level.
S096.042 Process	Current is in saturation level Monitor process conditions	Current is in saturation level	Monitor process conditions.

Table 4 LST300 diagnostic messages

9 Ex relevant specifications

Meter design for general purpose, Ex protection code Y0

IMPORTANT (NOTE)

For applications in US and Canada, when the temperature under rated conditions is higher than 60 °C at the entry point or 60 °C at the branching point of conductors, accessories such as cable, gland or conductors in conduit with minimum temperature specification of 60 °C must be selected.

IMPORTANT (NOTE)

The devices may only be operated in explosive areas if the housing covers have been fully closed.

WARNING

Static hazard clean only with a damp cloth.

Avertissement – Danger statique Nettoyez uniquement avec un chiffon humide.

IMPORTANT (NOTE)

“Y0” digit means general purpose.

Supply power terminals

UB = 12 to 42 V DC

Operation temperature ranges

- The ambient operating temperature range of the LST300 is between -40 °C and 85 °C (-40 °F and 185 °F).
- Pollution degree 3 (refer to IEC 60664-1) must not be exceeded for the macro environment of the device. The device conforms to degree of protection IP66 / IP67. If the device is installed as intended, this requirement is met by the housing as standard.

Meter design for NEPSI non sparking, ATEX/IECEX/UKCA energy limited (Zone 2 /22), cFMus division 2, Zone 2/22

Meter design for NEPSI Non Sparking, Ex protection code is C5.

Meter design for ATEX/IECEX/UKCA energy limited (Zone 2/22), Ex protection code is E5.

Meter design for cFMus, division 2. Zone 2/22, Ex protection code is F3.

IMPORTANT (NOTE)

For applications in US and Canada, when the temperature under rated conditions is higher than 60 °C at the entry point or 60 °C at the branching point of conductors, accessories such as cable, gland or conductors in conduit with minimum temperature specification of 60 °C must be selected.

IMPORTANT (NOTE)

The devices may only be operated in explosive areas if the housing covers have been fully closed.

WARNING

Static hazard clean only with a damp cloth.

Avertissement – Danger statique Nettoyez uniquement avec un chiffon humide.

IMPORTANT (NOTE)

“C5” digit means that customers choose NESPI Non Sparking method of protection on the product.

Dedicated check box is to be marked by the manufacturer.

IMPORTANT (NOTE)

“E5” digit means that customers choose ATEX or IECEx Non Sparking method of protection on the product.

Dedicated check box is to be marked by the manufacturer.

IMPORTANT (NOTE)

“F3” digit means that customers choose FM US or FM C Non Incendive method of protection on the product.

Dedicated check box is to be marked by the manufacturer.

NEPSI approval design for China

Ex nA IIC T6...T4 Ex tD A22 IP66/67 T85°C-T135°C

For electrical parameters, refer to cert, GYJ21.1162X

EU type-examination certificate FM15ATEX0064X, UKCA certificate: FM21UKEX0121X

Designation:

II 3 G Ex nA IIC T6...T4 Gc - II 3 D Ex tc IIIC T85°C-T135°C Dc

For electrical parameters, refer to cert, FM15ATEX0064X, FM21UKEX0121X

Certificate of conformity IECEx FME 15. 0010X

Designation:

Ex nA IIC T6...T4 Gc - Ex tc IIIC T85°C-T135°C Dc

For electrical parameters, refer to cert, IECEx FME 15.0010X

FM approval design for the USA and Canada

CL I, ZONE 2 AEx/Ex nA IIC T6...T4

CL I/DIV 2/GP ABCD

NI CL I/DIV 2/GP ABCD

DIP CL II, III/DIV 2/GP EFG

Supply power terminals

Um = 42 V DC

Operation temperature ranges

- Ambient operating temperature between -40 °C and 85 °C (-40 °F and 185 °F)
- Dependence on the temperature class as detailed in the tables below

Entity parameters for L2 display

Temperature class – Gas	Temperature class – Dust	Ambient temperature limitation
T4	T135 °C	-40 to 60 °C
T4	T135 °C	-40 to 60 °C
T5	T100 °C	-40 to 56 °C
T6	T85 °C	-40 to 44 °C

Entity parameters for L7 display

Temperature class – Gas	Temperature class – Dust	Ambient temperature limitation
T4	T135 °C	-40 to 85 °C
T4	T135 °C	-40 to 70 °C
T5	T100 °C	-40 to 40 °C
T6	T85 °C	-40 to 40 °C

Entity parameters for L0 display

Temperature class – Gas	Temperature class – Dust	Ambient temperature limitation
T4	T135 °C	-40 to 85 °C
T4	T135 °C	-40 to 70 °C
T5	T100 °C	-40 to 56 °C
T6	T85 °C	-40 to 44 °C

The devices must be installed in a protected environment in accordance with the specific conditions on the test certificate.

Pollution degree 3 (refer to IEC 60664-1) must not be exceeded for the macro environment of the device. The device conforms to degree of protection IP66 / IP67. If the device is installed as intended, this requirement is met by the housing as standard.

When connected to the line supply, the electrical circuits must not exceed overvoltage category III. When not connected to the line supply, the electrical circuits must not exceed overvoltage category II.

Meter design for NEPSI intrinsic safety, ATEX/IECEX/UKCA intrinsic safety (Zone 0/20), and cFMus division 1, Zone 0/20

Meter design for NEPSI intrinsic safety, Ex protection code is C6.

Meter design for ATEX/IECEX/UKCA intrinsic safety (Zone 0/20), Ex protection code is E6.

Meter design for cFMus division 1, Zone 0/20, Ex protection code is F4.

IMPORTANT (NOTE)

For applications in US and Canada, when the temperature under rated conditions is higher than 60 °C at the entry point or 60 °C at the branching point of conductors, accessories such as cable, gland or conductors in conduit with minimum temperature specification of 60 °C must be selected.

IMPORTANT (NOTE)

The devices may only be operated in explosive areas if the housing covers have been fully closed.

 **WARNING**

Static hazard clean only with a damp cloth.

Avertissement – Danger statique Nettoyez uniquement avec un chiffon humide.

IMPORTANT (NOTE)

“C6” digit means that customers choose NEPSI Intrinsically Safe method of protection on the product. Dedicated check box is to be marked by the manufacturer.

IMPORTANT (NOTE)

“E6” digit means that customers choose ATEX or IECEx Intrinsically Safe method of protection on the product. Dedicated check box is to be marked by the manufacturer.

IMPORTANT (NOTE)

“F4” digit means that customers choose FM US or FM C Intrinsically Safe method of protection on the product. Dedicated check box is to be marked by the manufacturer.

NEPSI approval design for China

Ex ia IIC T6...T4 Ga Ex iaD 20 T85°C-T135°C

For electrical parameters, refer to cert, GYJ21.1163

EU type-examination certificate FM15ATEX0063X, UKCA certificate: FM21UKEX0120X
Designation:

II 1 G Ex ia IIC T6...T4 Ga - II 1 D Ex ia IIIC T85° C -T135°C Da

For electrical parameters, refer to cert, FM15ATEX0063X, FM21UKEX0120X

Certificate of conformity IECEx FME 15. 0010X**Designation:**

Ex ia IIC T6...T4 Ga - Ex ia IIIC T85°C-T135°C Da

For electrical parameters, refer to cert, IECEx FME 15.0010X

FM approval design for the USA and Canada

IS/Sec. Intrinsic (Entity) CL I

ZONE 0 AEx/Ex ia IIC T6...T4

CL I/DIV 1/GP ABCD IS - CL II,III DIV 1/GP EFG

IS Control Drawing number: 3KXL065035U0009

Supply power terminals

Refer to the tables below

Operation temperature ranges

- Ambient operating temperature between -40 °C and 85 °C (-40 °F and 185 °F)
- Dependance on the temperature class as detailed in the tables below

Entity parameters for L2 display

Temperature class – Gas	Temperature class – Dust	Ambient temperature limitation	Input				
			Current limitation	Voltage limitation	Power limitation	Ci	Li
T4	T135 °C	-40 to 60 °C	100 mA	30 V	0.75 W	17 nF	10 uH
T4	T135 °C	-40 to 60 °C	160 mA	30 V	1 W		
T5	T100 °C	-40 to 56 °C	100 mA	30 V	1.4 W		
T6	T85 °C	-40 to 44 °C	50 mA	30 V	0.4 W		

Entity parameters for L7 display

Temperature class – Gas	Temperature class – Dust	Ambient temperature limitation	Input				
			Current limitation	Voltage limitation	Power limitation	Ci	Li
T4	T135 °C	-40 to 85 °C	100 mA	30 V	0.75 W	13 nF	10 uH
T4	T135 °C	-40 to 70 °C	160 mA	30 V	1 W		
T5	T100 °C	-40 to 40 °C	100 mA	30 V	1.4 W		
T6	T85 °C	-40 to 40 °C	50 mA	30 V	0.4 W		

Entity parameters for L0 display

Temperature class – Gas	Temperature class – Dust	Ambient temperature limitation	Input				
			Current limitation	Voltage limitation	Power limitation	Ci	Li
T4	T135 °C	-40 to 85 °C	100 mA	30 V	0.75 W	17 nF	10 uH
T4	T135 °C	-40 to 70 °C	160 mA	30 V	1 W		
T5	T100 °C	-40 to 56 °C	100 mA	30 V	1.4 W		
T6	T85 °C	-40 to 44 °C	50 mA	30 V	0.4 W		

The devices must be installed in a protected environment in accordance with the specific conditions on the test certificate.

Pollution degree 3 (refer to IEC 60664-1) must not be exceeded for the macro environment of the device. The device conforms to degree of protection IP66 / IP67. If the device is installed as intended, this requirement is met by the housing as standard.

When connected to the line supply, the electrical circuits must not exceed overvoltage category III. When not connected to the line supply, the electrical circuits must not exceed overvoltage category II.

Meter design for NEPSI intrinsic safety, ATEX/IECEX/UKCA intrinsic safety (Zone 0/20), and cFMus division 1, Zone 0/20

Meter design for NEPSI combined C5 + C6, Ex protection code is C7.

Meter design for ATEX/IECEX/UKCA combined E5 + E6, Ex protection code is E7.

Meter design for cFMus, combined F3 + F4, Ex protection code is F8.

IMPORTANT (NOTE)

For applications in US and Canada, when the temperature under rated conditions is higher than 60 °C at the entry point or 60 °C at the branching point of conductors, accessories such as cable, gland or conductors in conduit with minimum temperature specification of 60 °C must be selected.

IMPORTANT (NOTE)

The devices may only be operated in explosive areas if the housing covers have been fully closed.

 **WARNING**

Static hazard clean only with a damp cloth.

Avertissement – Danger statique Nettoyez uniquement avec un chiffon humide.

IMPORTANT (NOTE)

“C7” digit means that customers choose NEPSI Non Sparking or Intrinsically Safe method of protection on the product. Dedicated check box is to be marked by the manufacturer or customers.

IMPORTANT (NOTE)

“E7” digit means that customers choose ATEX or IECEx Non Sparking or Intrinsically Safe method of protection on the product. Dedicated check box is to be marked by the manufacturer or customers.

IMPORTANT (NOTE)

“F8” digit means that customers choose FM US or FM C Non incensive or Intrinsically Safe method of protection on the product.

Dedicated check box is to be marked by the manufacturer or customers.

IMPORTANT (NOTE) – Note for transmitter with combined approval

Before installation of the transmitter, customers should permanently mark their chosen Protection Concept on the safety label. The transmitter can only be used according to this Protection Concept for the whole life.

If two or more types of protection box (on the safety label) are permanently marked, the transmitter must be removed from hazardous classified locations.

The selected Type of Protection is allowed to be changed only by the manufacturer after a new satisfactory assessment.

NEPSI approval design for China (Non Sparking)

Certificate No.: GYJ1162.X

For detailed information, refer to section “Meter design for NEPSI non sparking, ATEX/IECEX/UKCA energy limited (Zone 2/22), cFMus division 2, Zone 2/22”.

NEPSI approval design for China (Intrinsically Safe)

Certificate No.: GYJ21.1163X

For detailed information, refer to section “Meter design for NEPSI intrinsic safety, ATEX/IECEX/UKCA intrinsic safety (Zone 0/20), and cFMus division 1, Zone 0/20”.

EC type-examination certificate FM15ATEX0064X, UKCA certificate FM21UKEX0121X

Designation:

II 3 G Ex nA IIC T6...T4 Gc - II 3 D Ex tc IIIC T85°C-T135°C Dc

For electrical parameters, refer to cert, FM15ATEX0064X, FM21UKEX0121X

Certificate of conformity IECEx FME 15. 0010X

Designation:

Ex nA IIC T6...T4 Gc - Ex tc IIIC T85°C

For electrical parameters, refer to cert, IECEx FME 15.0010X

For detailed information, refer to section “Meter design for NEPSI non sparking, ATEX/IECEX/UKCA energy limited (Zone 2/22), cFMus division 2, Zone 2/22”.

EU type-examination certificate FM15ATEX0064X, UKCA certificate: FM21UKEX0121X

Designation:

II 1 G Ex ia IIC T6...T4 Ga - II 1 D Ex ia IIIC T85°C - T135°C Da

For electrical parameters, refer to cert, FM15ATEX0063X, FM21UKEX0120X

Certificate of conformity IECEx FME 15. 0010X

Designation:

Ex ia IIC T6...T4 Ga - Ex ia IIIC T85°C-T135°C Da

For electrical parameters, refer to cert, IECEx FME 15.0010X

For detailed information, refer to section “Meter design for NEPSI intrinsic safety, ATEX/IECEX/UKCA intrinsic safety (Zone 0/20), and cFMus division 1, Zone 0/20”.

FM approval design for the USA and Canada (Non Incensive)

CL I, ZONE 2 AEx/Ex nA IIC T6...T4

CL I/DIV 2/GP ABCD

NI CL I/DIV 2/GP ABCD

DIP CL II, III/DIV 2/GP EFG

For detailed information, refer to section “Meter design for NEPSI non sparking, ATEX/IECEX/UKCA energy limited (Zone 2/22), cFMus division 2, Zone 2/22”.

FM approval design for the USA and Canada (Intrinsically Safe)

IS/Sec. Intrinseque (Entity) CL I

ZONE 0 AEx/Ex ia IIC T6...T4

CL I/DIV 1/GP ABCD IS - CL II,III DIV 1/GP EFG

IS Control Drawing number: 3KXL065035U0009

For detailed information, refer to section “Meter design for NEPSI intrinsic safety, ATEX/IECEX/UKCA intrinsic safety (Zone 0/20), and cFMus division 1, Zone 0/20”.

Specific Conditions of Use

When the manufacturer of the equipment has not identified the type of protection on the label (option a = E7 or F8), the user shall, on installation, mark the label with the type of protection used.

The painted surface of the LST300 may store electrostatic charge and become a source of ignition in applications with a low relative humidity <~30% relative humidity where the painted surface is relatively free of surface contamination such as dirt, dust, or oil. Guidance on protection against the risk of ignition due to electrostatic discharge can be found in IEC TR60079-32-1. Cleaning of the painted surface should only be done with a damp cloth.

For type of protection “n”, provision shall be made external to the equipment, to provide the transient protection device to be set at a level not exceeding 140 % of the peak rated voltage value of 42 V.

For option d (housing material) equals A1 or B1 the enclosure contains aluminum and is considered to present a potential risk of ignition by impact or friction. Care must be taken into account during installation and use to prevent impact or friction.

10 Specification

Measurement

Measurement range

C06 sensor: 0.25 to 6 m (10" to 20 ft)

C10 sensor: 0.35 to 10 m (14" to 32 ft)

Beam angle (@ -3dB, full angle)

C06 sensor: 14°

C10 sensor: 10°

Accuracy

±2 mm (0.08") or 0.2 % of full span (the larger of the two)

Repeatability

±0.2 % of measurement range

Mechanical data

Housing material

Metal parts: Aluminum alloy

Plastic parts: PVDF

Dimensions

Length: 136 mm (5.3")

Width: 100 mm (3.9") (excluding glands)

Height: 266 mm (10.4")

Weight

2 kg (4.4 lbs)

Cable entry type

Two options:

1/2 in. threaded bore for cable gland, directly on housing:

Supplied with 1 x 1/2 in. NPT cable gland

M20 x 1.5 threaded bore for cable gland, directly on housing:

Supplied with M20 x 1.5 cable gland

Electrical data

Terminals

Three connections for wire cross sections of up to 2.5 mm² (14 AWG) as connection points for power supply and communication purposes

Grounding

Internal and external ground terminals are provided for 6 mm² (10 AWG) wire cross sections

Power supply

The transmitter operates from 12 to 42 V DC with no load and is protected against reversed polarity (additional loads like HART resistance and conductor resistance enable operation above 42 V DC).

During use in Exia zones and in other intrinsically safe applications, the power supply must not exceed 30 V DC.

Ripple

Max. 2.2 mV RMS over a 500 Ω load as per HART specifications

Load limitations

Total measurement circuit resistance at 4 to 20 mA and HART:

$$R(k\Omega) = \frac{\text{Voltage supply} - \text{Minimum operating voltage (V DC)}}{22 \text{ mA}}$$

A minimum resistance of 250 Ω is required for HART communication.

Analog output

Two-Wire output: 4 to 20 mA related to level / volume / flow, full compensation for temperature effects

Displays (option)

Integrated LCD display (code L7)

Widescreen LCD display, 128 x 64 pixels, 52.5 x 27.2 mm (2.06 x 1.07 in.) dot matrix

Four keys for device configuration and management

Easy setup for quick commissioning

Customized visualizations which users can select

Totalized and actual value flow indication

Temperature and diagnostics message display, and configuration settings

Integrated LCD display with TTG operation (code L2)

Same specifications as the integrated LCD display (code L7) An innovative Through-The-Glass (TTG) keypad which can be used to activate the device configuration and management menus without having to remove the transmitter housing cover TTG keys protected against accidental activation

Hazardous area approvals

cFMus

Intrinsic Safety type of protection:

Approval according to FM US and Canada IS Class 1 Div 1/
GP ABCD- CL II/ DIV 1/ GP EFG, Zone 0 AEx/Ex ia IIC T6...T4
IS Control Drawing number: 3KXL065035U0009

Non Incendive type of protection:

Approval according to FM US and Canada NI Class 1 Div 2/GP
ABCD- DIP CL II/ DIV 2/ GP EFG, Zone 2, AEx/Ex nA IIC T6...T4

ATEX/IECEX/UKCA

Intrinsic Safety type of protection:

II 1 G Ex ia IIC T6...T4 Ga - II 1 D Ex ia IIIC T85° C
For electrical parameters, refer to cert, FM15ATEX0063X
Ex ia IIC T6...T4 Ga - Ex ia IIIC T85° C
For electrical parameters, refer to cert, IECEX FME 15.0010X

Non Incendive type of protection:

II 3 G Ex nA IIC T6...T4 Gc - II 3 D Ex tc IIIC T85° C
For electrical parameters, refer to cert, FM15ATEX0064X
Ex nA IIC T6...T4 Gc - Ex tc IIIC T85° C
For electrical parameters, refer to cert, IECEX FME 15.0010X

NEPSI

Intrinsic Safety type of protection:

Ex ia IIC T6...T4 Ga - Ex iaD 20 T85° C
For electrical parameters, refer to cert, GYJ21.1163X

Non Incendive type of protection:

Ex nA IIC T6...T4 Gc - DIP A22 TA85° C
For electrical parameters, refer to cert, GYJ1162.X

Environmental data

Electromagnetic compatibility (EMC)

Meets requirements of EN 61326
Overvoltage strength (with surge protection): 2 kV (according
to IEC 61000-4-5)

Temperature

-40 to 85 °C (-40 to 185 °F), according to EN 60068-2-14, 1 K/
min, 100 cycles

Humidity

Relative humidity: Up to 100 %
Condensation, icing: Not permissible

Pressure

Measurement functional from -4 to 44 psi (-0.25 to 3.0 bar)

Vibration resistance

Acceleration up to 1 g at frequencies of up to 2,000 Hz
(according to EN 60068-2-64)

Climate class

DIN EN 60068-2-38 (Test Z/AD) DIN/IEC 68 T2-30Db

Note

ABB Engineering (Shanghai) Ltd
Measurement & Analytics

No. 4528, Kangxin Highway,
Pudong New District Shanghai,
201319, P.R. China

Tel: +86(0) 21 6105 6666

Fax: +86(0) 21 6105 6677

Mail: china.instrumentation@cn.abb.com

Service Hotline: +86 400 620 9919

Service e-mail:

instrumentservice abbchina@cn.abb.com

ABB Inc.

Process Automation

125 E. County Line Rd
Warminster PA 18974-4995, USA

Tel: +1 215 674 6000

Fax: +1 215 674 7183

ABB Limited

Process Automation

Howard Road
St. Neots
Cambridgeshire PE19 8EU
UK

Tel: +44 (0)1480 475321

Fax: +44 (0)1480 217948

www.abb.com/level

Note

We reserve the right to make technical changes or modify the contents of this document without prior notice. With regard to purchase orders, the agreed particulars shall prevail. ABB does not accept any responsibility whatsoever for potential errors or possible lack of information in this document.

We reserve all rights in this document and in the subject matter and illustrations contained therein. Any reproduction, disclosure to third parties or utilization of its contents – in whole or in parts – is forbidden without prior written consent of ABB.

Copyright© 2022 ABB All rights reserved