

Subject to technical changes.

This technical documentation is protected by copyright. Translating, photocopying and disseminating it in any form whatsoever - even editings or excerpts thereof - especially as reprint, photomechanical or electronic reproduction or storage on data processing systems or networks is not allowed without the permission of the copyright owner and non-compliance will lead to both civil and criminal prosecution.



Table of contents

| | Page |
|--|------|
| Field of application | 4 |
| Installation | |
| Instrument identification | 4 |
| Selecting the mounting site | 4 |
| Mounting | 5 |
| Installing the leads | 5 |
| Connection system | 6 |
| Signal inputs | 6 |
| Analog output | 7 |
| Relay output | 7 |
| Binary input/output module | 8 |
| Power supply | 8 |
| Serial interface | 9 |
| Commissioning | |
| Switching on | 10 |
| Presentation of the displays | 10 |
| Adjustment of values | 11 |
| Changeover of mode | 11 |
| Setting parameter | 12 |
| Self parameter setting | 12 |
| Parameter table | 12 |
| Operation | |
| Displays | 14 |
| Adjustment of values | 15 |
| Messages from the self-monitoring | |
| General error messages | 15 |
| Error messages from the input monitoring | 16 |

2 Table of contents

| | Page |
|---|------|
| Configuration | 16 |
| Line balancing with resistance thermometer | 21 |
| Maintenance | 22 |
| Packing instructions | 23 |
| Spare parts | 23 |
| Appendix | |
| Technical data | 25 |
| Ordering matrix | 29 |
| Examples of application | 31 |

Scope of delivery:

- 1 Bitric P
- 2 Fasteners
- (if ordered, screw terminals
- serial interface
- binary I/O module)

Supplementary documents:

- Data Sheet 10/61-2.10 EN
- Service Information Cat. No. (B-Nr.) 98061-5-6675252
- Interface description RS-485
- (Operating manual 42/61-42 EN)

Subject to technical changes.
Reproduction and translation, wholly or in part,
are not permitted without our prior consent.

Important Instructions for Your Safety.

Please read and observe.

Correct and safe operation of the Industrial Controller Bitric P calls for appropriate transportation and storage, expert installation and commissioning as well as correct operation and meticulous maintenance.

Only those persons conversant with the installation, commissioning, operation and maintenance of similar apparatuses and who possess the necessary qualifications are allowed to work on the apparatus.

Please take note of

- the contents of this Operating Manual,
- the safety regulations affixed to the apparatus,
- the safety regulations pertaining to the installation and operation of electrical systems.

The directives, norms and guidelines mentioned in this Operating Manual are applicable in the Federal Republic of Germany. When using the apparatus in other countries, please observe the national regulations prevailing in the respective country.

The controller Bitric P has been designed and tested in accordance with DIN VDE 0411 Part 1, "Safety requirements for electronic measuring apparatuses", and has been supplied in a safe condition. In order to retain this condition and to ensure safe operation, the safety instructions in this Operating Manual bearing the headline "Caution" must be observed. Otherwise, persons can be endangered and the apparatus itself as well as other equipment and facilities can be damaged.

If the information in this Operating Manual should prove to be insufficient in any point, the ABB Service Department will be delighted to give you more information.

Field of application

The digital industrial controller Bitric P with a continuous control output is applied preferentially for temperature control tasks, especially in heat-treatment processes.

Besides temperature control, it is also suitable for steering electro-pneumatic or electro-hydraulic actuators or thyristor actuators and for solving other tasks such as flow, pressure and mixture control.

Installation

Instrument identification

Information in the form of a numeral and line code specifying the factory settings is given on the rating plate of the instrument.

The P No. can be decoded using the ordering matrix (see page 28).

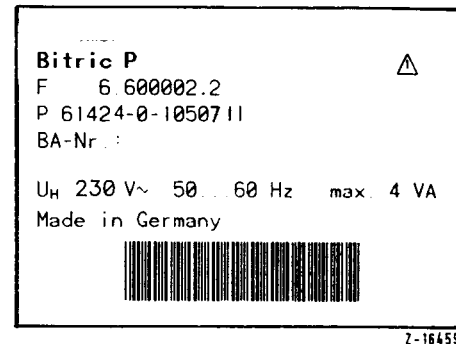

Fig. 1 Rating plate

Selecting the mounting site

When selecting the mounting site bear in mind the permissible climatic and mechanical stipulations given in the Technical Data (see Appendix), like for example:

Ambient temperature

0...+50 °C

Relative humidity

≤75 % annual average, 95 % for short periods

Occasional and slight condensation

Mounting

The instrument is pushed from the front into the panel cutout and is secured there by means of the fasteners which have been supplied.

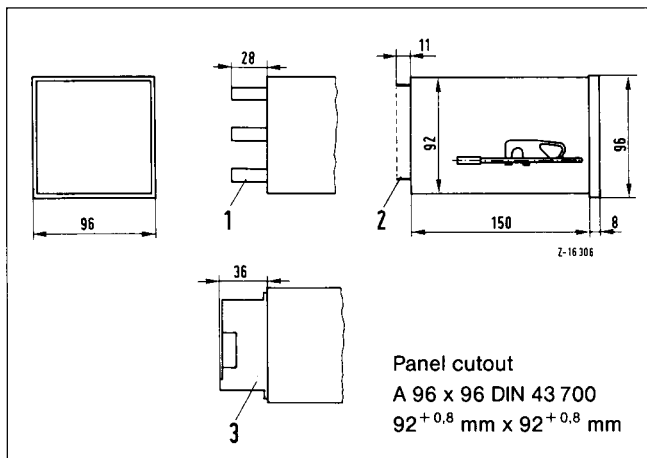

Fig. 2 Dimensional drawing (dimensions in mm)

- 1 Bitric P with multi plug connector
- 2 Bitric P with blade-type connector
- 3 Bitric P with serial interface RS-485 or binary I/O module

Installing the leads

On selecting the material of the leads and on installing them bear in mind the regulations valid in your country for installing power systems with rated voltages up to 1000 V (in Germany: DIN VDE 0100).

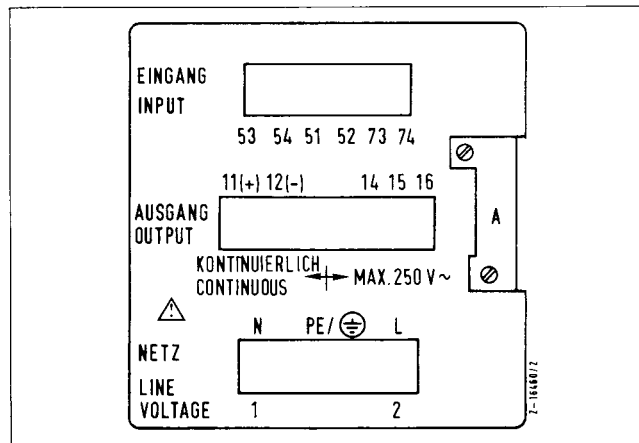

Fig. 3 Connection side

A = Slot for serial interface or binary I/O module

A connection between the grounding conductor terminal PE/⊕ and the grounding conductor has to be established before any other connection for protection against electric shock. It must thus be provided even for a power supply of 24 VAC.

Inside the instrument itself, the reference conductor terminal (⊥) is connected with PE/⊕ via an 0.1 μF capacitor.

The contacts to the metallic control panel necessary for keeping up the interference immunity are established through the hardened tips of the fasteners during unit mounting.

Connection system

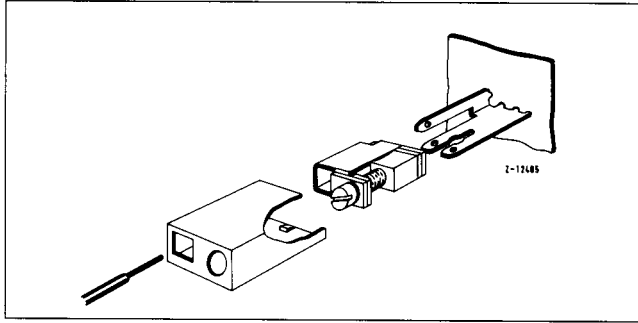

Fig. 4 Mounting the screw terminals

Connection is established via tab connectors A 6.3 x 0.8 or A 2.4 x 0.8 (DIN 46 422) or pole 2.4 x 0.8 (DIN 41 611).

Screw terminals are available optionally as additional components (Catalog No. 610404-4-0342910; 1 Set with 15 pieces).

In a special version the connection side features multi plugs with terminals, coded in a manner which ensures that the connections are not mixed up.



Attention

The outer, movable conductors must be affixed in a way that the conductor terminals to the controller or binary or interface module are free of tensile load.

The multiplug for the power supply (mains) may only be plugged on or loosened if free of tensile force.

All conductors which might carry dangerous contact voltages must be equipped with isolated terminals.

Signal inputs

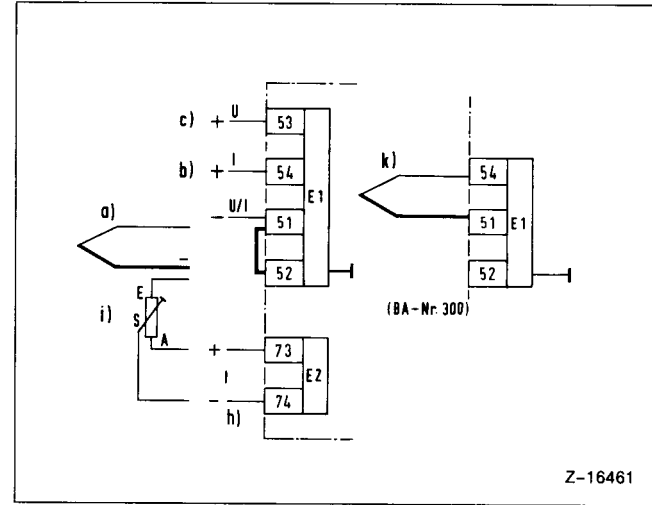

Fig. 5 Signal inputs mV, mA, V

- a) mV or thermocouple
- b) Current (mA) } sequence variable
- c) Voltage (V) } with ratio
- h) Auxiliary variable additionally to x or w external setpoint w_e or reference variable with ratio
- i) External setpoint w_e
- k) mV or thermocouple with electronic potential separation

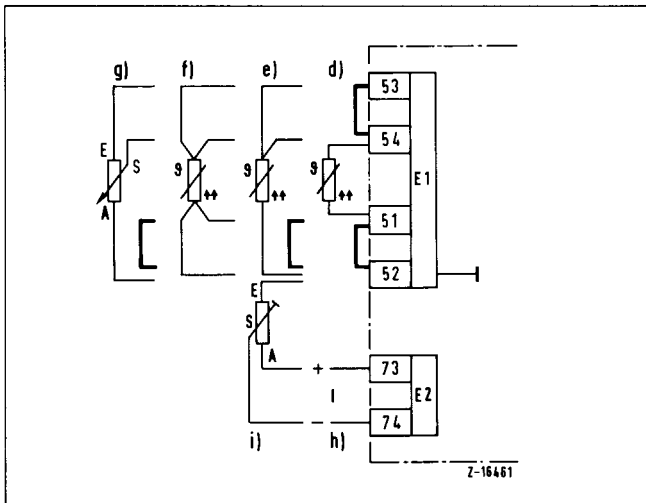

Fig. 6 Signal inputs resistance measurement

- d) Two-wire circuit
- e) Three-wire circuit
- f) Four-wire circuit
- g) Teletransmitter as primary detector
- h) Auxiliary variable additionally to x or w ;
external setpoint w_e
- i) External setpoint w_e

Ratio

The current source for the reference variable w is connected directly to input E2 and reference variable is connected to input E1.

Line balancing with resistance thermometer

The line resistance can be balanced. The measures to be taken are described in Section "Configuration".

Analog output

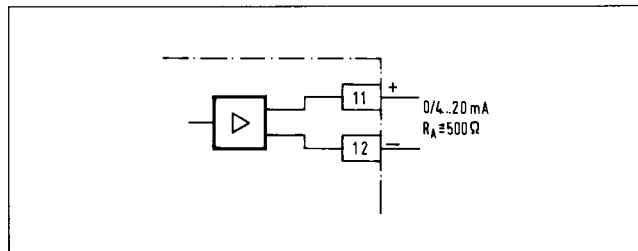

Fig. 7 Analog output

Relay output

The contacts of the incorporated relays are wired with a spark quenching element with dimensions sufficient for driving small and medium inductive loads.

In the case of greater inductive loads, an external spark quenching element is recommended for the protection of the contacts.

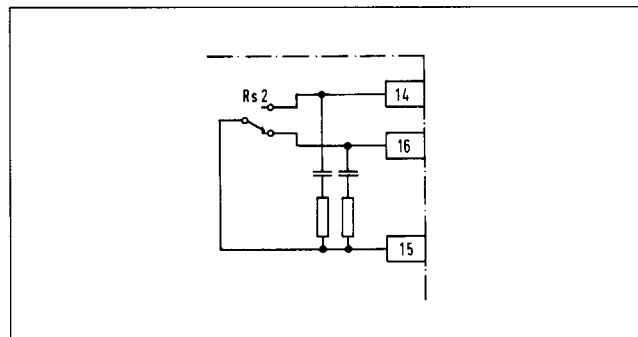

Fig. 8 Relays output with potential free change-over contact

Binary I/O module

A binary module can be supplied as option or for subsequent extensions (Fig. 9 and 10). Module labelling: Binary Module I/O.

Power supply

The connection voltage valid for the instrument is imprinted on the rating plate. See Technical Data for further details (Appendix). The terminal assignment is displayed in Fig. 3.

The unit contains an installed thermal release.

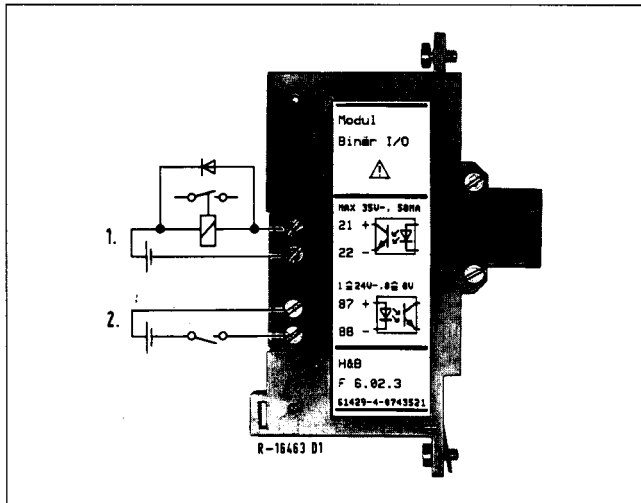

Fig. 9 Binary module

- 1) Additional alarm signal max. load 35 VDC; 50 mA
- 2) w_i/w_e changeover L = -3... +5 VDC (w_i active)
H = +13... +30 VDC (w_e active)

8 Installation

Caution

It must be possible to switch off the power supply externally at two-poles.

In order to provide protection against accidental contact with terminals, the Bitric P must be installed appropriately.

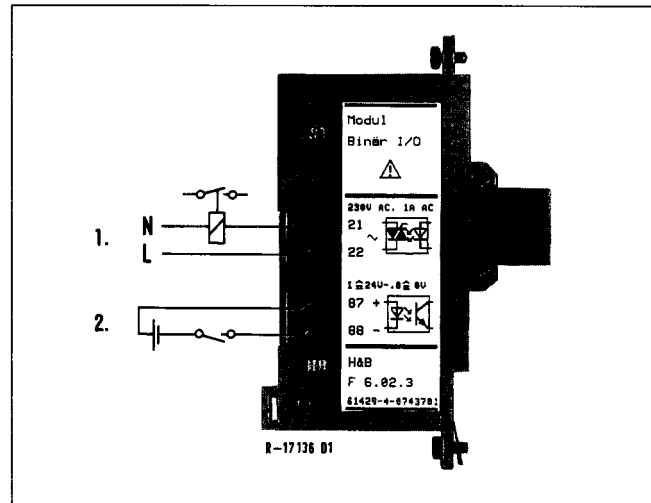

Fig. 10 Binary I/O module with Triac output

- | | |
|----------------------|--|
| 1) Binary output | Load: 230 VAC; max. 1 A |
| 2) Binary input | 0 $\hat{=}$ -3... +5 VDC (w_i active) |
| w_i/w_e switchover | 1 $\hat{=}$ +13... +30 VDC (w_e active) |

Serial interface

The serial interface RS-485 (Fig. 11) can be supplied as option or for a subsequent extension.

Bus cable

Shielded with braiding or foil, at least 3 cores. A shield for interference immunity and radio interference suppression is required.

Connection:

| | |
|----------------------------|---|
| Terminal 1 (P) | } if nec.: (+) V_{ext} (see Fig. 11) 2 data wires Must not be mixed up. Reference conductors: 3 or resp. remaining wires in parallel and, if nec., (-) V_{ext} (see Fig. 11) Cable shield |
| Terminal 2 (A = RxD/TxD-P) | |
| Terminal 3 (B = RxD/TxD-N) | |
| Terminal 4 (C = DGND) | |

Terminal 5 (\pm)
(See also DIN 19 245 T1/4.91)

Cable shield

- For the control group the cable shield must be contacted with a flat metallic cabinet part by means of a clamp for braiding or sheat wire near to the cabinet entry.
- At each module the cable shield must be connected with terminal 5 in a max. distance of 1 cm. At the PC, the shield is contacted by means of a plug.

Reference

If the interface cable does, as an exception, not contain a reference conductor a disturbance-free functioning can only be guaranteed if the equipotential difference between the DGND connections of all bus subscribers does not exceed ± 7.0 V.

Line terminal

A standardized bus-terminating resistor is not required for the Bitric P and not permissible for line reasons.

Potential separation

If not all sensors and, if applicable, current outputs of the controller group are floating the module must be supplied by an external, electrically isolated, interference-proof source of $V_{ext} = 6$ VDC $\pm 5\%$, $I = 20$ mA (peak value $i = 150$ mA) at terminals 1 and 4. Otherwise, measured values might be falsified.

Recommendation:

H&B mains rectifier TZG 6, Catalogue No.: 14691-0-1200000.
A parallel supply of several modules is possible with a stronger source.

The **message structure** is based on DIN 19 245.

A description of the message is given in the "Interface Description 42/61-42-EN".

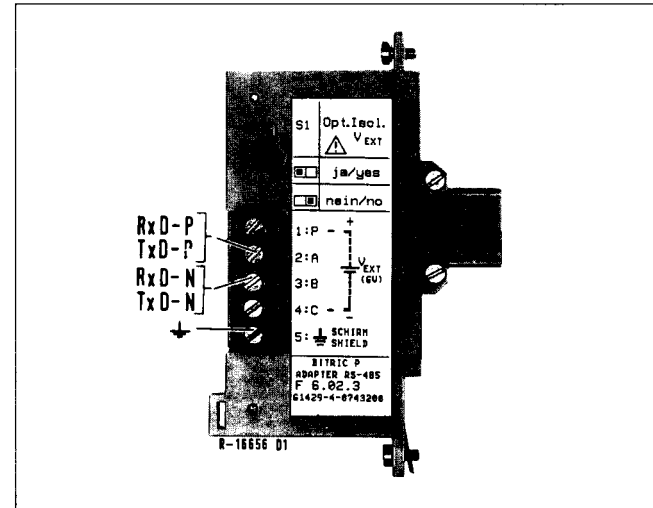

Fig. 11 Connection of serial interface RS-485

Commissioning

⚠ Caution:

The unit may only be operated when properly built in.
Before switching on make sure that the operating voltage given on the rating plate corresponds to mains voltage.
The grounding conductor must be linked with the connection marked with PE / ⊕.

Switching on

Once all the lines have been connected and the mains voltage switched on, Bitric P is immediately ready for operation.
The controlled variable x is indicated.

Presentation of the displays

The main display (1) shows normally the controlled variable x.

■ With **P** the function display (2) and hence the main display is switched over.

The order of the functions is shown in the Fig. 13.

- Tipping the key **P** : Switch over clockwise
- Holding the key **P** : Switch over counterclockwise

The relationship between the function display and the main display is shown in Table 1. Functions not available are suppressed.

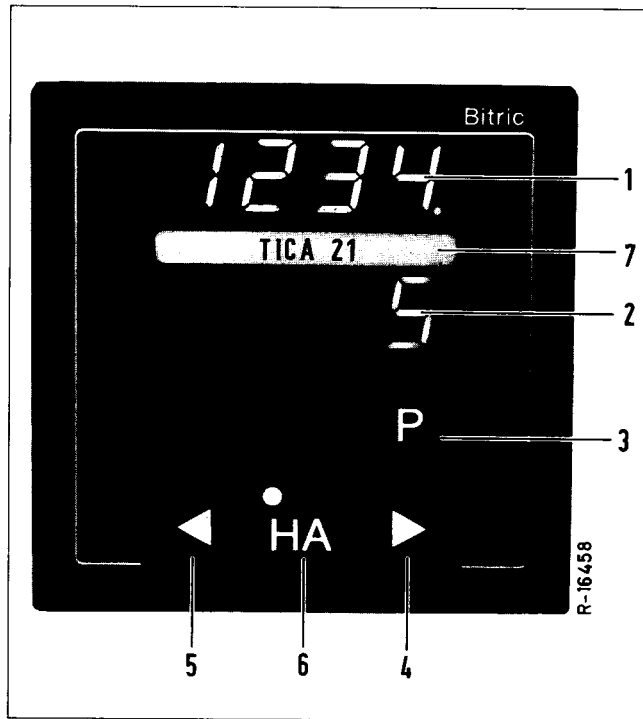

Fig. 12 Front view of Bitric P

- 1 Main display
- 2 Function display
- 3 Display changeover (designated as **P** in text)
- 4 Adjustment "raise" (designated as ► in text)
- 5 Adjustment "lower" (designated as ◀ in text)
- 6 Mode selector switch (designated as **HA** in text)
- 7 Inscription plate

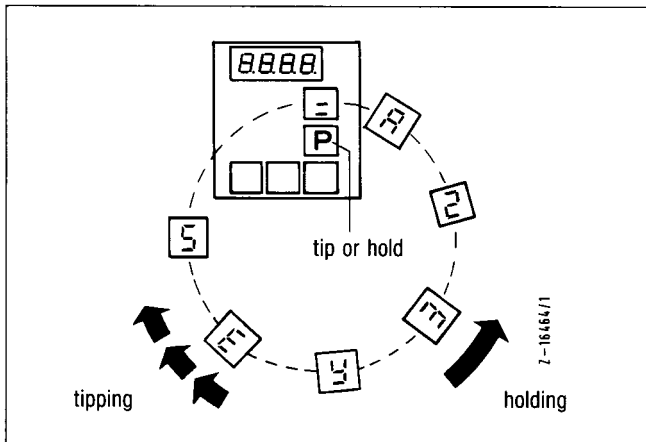

Fig. 13 Sequence of the functions

| Function display | Main display | Display in: |
|------------------|---------------------|-------------|
| see Fig. 13 | Controlled variable | Phys. unit |
| S | Set point | Phys. unit |
| E | Control deviation | Phys. unit |
| Y | Output variable | % |
| 3 | Alarm value 3 | Phys. unit |
| 2 | Alarm value 2 | Phys. unit |
| A 1) | External set point | Phys. unit |

Table 1

1) Only present with w_i / w_e changeover

During the indication of the controlled variable, the switching pulses are depicted in the function display (2).

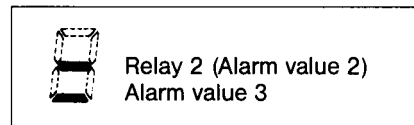

Fig. 14 Display of the switching pulses in the function display

Adjustment of values

- With ◀ or ▶ the value indicated in each case can be adjusted in so far as it is adjustable.

Weighting of the inputs

All inputs can be weighted.

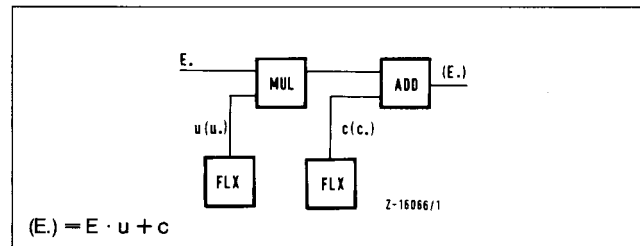

Fig. 15 Input weighting

Display and setting of the values u and c takes place in the parameter definition level.

Changeover of mode

- With **HA** manual mode or automatic mode can be selected.
- The LED in the key indicates the manual mode.

Setting parameter

Parameters are set in accordance with the setting rules given in the documentation on this subject or known by experience or by means of the self-parameter setting function of the unit.

Self-parameter setting

Self-parameter setting determines the values for the proportional range X_p , integral action time T_n and derivative action time T_v . Other parameters e.g. the dead zone must be set previously.

■ Calling the self-parameter setting:

1. Holding of **P** and tipping of **▶** twice slowly. Information **tune** appears.
2. Further switching with **P**, the display **OFF** appears.
3. Changeover of the display with **▶** to **On**.

Thus the self-parameter setting is started. The display switches over to indicate the set point.

With a control deviation greater than 5 %, the controller immediately begins determination of the parameters. If the control deviation is less than 5 %, the set point must be changed so as to reach a control deviation of at least 5 %.

As a request to change the set point, the set point flashes until a sufficient control deviation is produced. Five seconds after the set point has been changed determination of parameters starts. Any subsequent change of set point would result in abortion of the self parameter setting.

During the self-parameter setting the LED in the **HA** key flashes. H/A changeover is blocked.

On completion of the self-parameter setting, the controller switches to automatic mode and controls the controlled variable to the set point set.

12 Commissioning

Basic conditions for the self-parameter setting:

- The self-parameter setting should only be started if the controlled variable was constant for some time (stationary status).
- The control jump must produce a control deviation of at least 5 %. For that, a suitable setpoint and operating point must be selected.

Parameter table

■ **Switchover** to the parameter setting level **PAR**, self-parameter setting **tune** and configuration level

----- is effected by means of:

- Holding **P** and key **▶**.
- Switchover takes place on releasing key **▶** in each case.

■ **Paging within** the parameter setting level from top to bottom:

- Tipping of key **P**:
On reaching the bottommost position, the uppermost position is selected again.
- By holding **P**, paging from bottom to top is effected.

■ **Return to the operating level:**

- Holding of **P** and **◀** for more than 4 seconds.





| Level | Display | Factory-setting | Function display flashes | Description of function |
|-------------|--|-------------------------------------|---------------------------|---|
| Par | Value Value Value Value | 100 % 40 s 10 s 50 % | P n d h t | Parameter setting level Proportional range Integral action time 1 ... 1999 s or 1 ... 199.9 min Derivative action time 1 ... 1999 s or 1 ... 199.9 min Operating point in controllers without I-section: 0 ... 100 %; With I-section: adjustable from 50 ... 100 %; does influence the start-up behaviour not with Continuous Controller |
| | Value Value Value | 100 % 0 % 100 % | H L O | Upper set point limit Lower set point limit Upper output limit |
| | Value Value | 0 % 100 % | U u | Lower output limit Weighting factor input 1, multiplication $\pm 0 \dots 199.9 \%$ |
| | Value Value Value Value Value | 0 % 100 % 40 s 10 s 5 s | c P. n. d. t. | Weighting of input 1, addition $\pm 0 \dots 199.9 \%$ or in physical units } not with Continuous Controller |
| | Value Value Value | 100 % 0 % 0 % | u. c. A. | Weighting factor of input 2, multiplication $\pm 0 \dots 199.9 \%$ Weighting of input 2, addition $\pm 0 \dots 199.9 \%$ or in physical units Value of the input 2 |
| | tunE | OFF / ON | OFF | off |
| ConF |   | | | Gate to configuration level: Access by holding  and  for more than 4 s or entering a code digit. The display C o n F appears, see section "Configuration" |

Table 2 Parameter table

Operation

Displays

The main display (1) shows normally the controlled variable x .

■ With **P** the function display (2) and hence the main display is switched over.

- Tipping the key **P** : Switch over clockwise
- Holding the key **P** : Switch over counterclockwise

The relationship between the function display and the main display is shown in Table 3.

Functions not available are suppressed.

| Function display | Main display | Display in: |
|------------------|---------------------|-------------|
| See Fig. 16 | Controlled variable | Phys. unit |
| S | Set point | Phys. unit |
| E | Control deviation | Phys. unit |
| Y | Output variable | % |
| 3 | Alarm value 3 | Phys. unit |
| 2 | Alarm value 2 | Phys. unit |
| A ¹⁾ | External set point | Phys. unit |

Table 3

During the indication of the controlled variable, the switching pulses are depicted in the function displays (2) in the case of on/off, three-position and step controllers

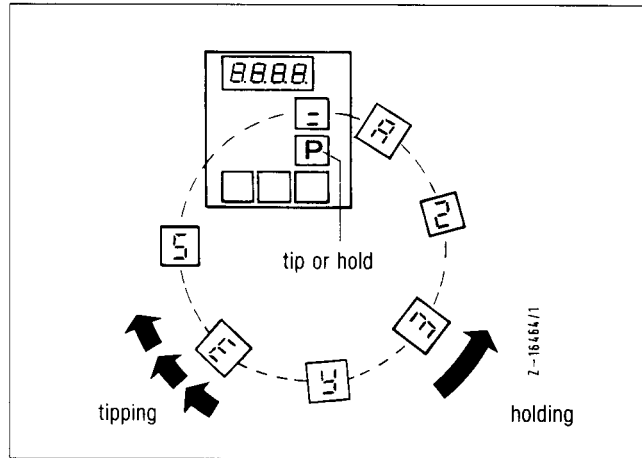

Fig. 16 Sequence of the functions

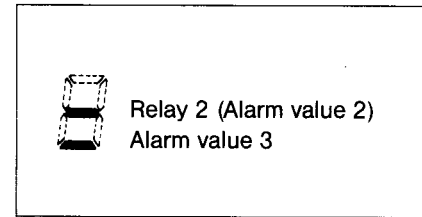

Fig. 17 Display of the switching pulses in the function display

¹⁾ Only present with w_i / w_e changeover

Adjustment of values

Set point

- Select set point function display.
- Adjust set point, in so far as adjustable, by using the keys ◀ and ▶.

Operating mode changeover

- With **HA** it can be selected between manual or automatic mode.
The LCD in this key indicates the **manual** mode.

Adjusting the output variable y

- After switching-over to "Manual" without impact, "Y" is automatically displayed.
- Alter the correcting variable with ◀ or ▶ .
 - slower change by **tip**ping ◀ or ▶ .
 - quicker change by **hold**ing ◀ or ▶ .
 - Rapid adjustment to 0 or 100 % by **hold**ing ◀ or ▶ **and concurrently tipping** the **HA**-key.

Alarm values

- Select alarm values 2 or 3 provided their adjustment is enabled.
- Set with ◀ or ▶ .

Alarm values that monitor the measured value or control deviation are indicated in physical units. The right decimal point in the main display flashes.

Messages from the self-monitoring

General error messages

The following faults are detected in the Bitric P and indicated in the main display (1) for 0.5 s and repeated every 6 s.

If several faults occur simultaneously they are shown successively acc. to the order below. With this group of faults the message arrived is not deleted even though the cause no longer exists.

- Acknowledge fault with **P**



- Hardware fault. The running calculation of the checksum EPROM is wrong.



- Error in the self-parameter definition (selftune).



- Serial EEPROM defective; writing or reading error.



- Data was brought too quickly in succession to the serial EEPROM. Queue full.

Error messages from the input monitoring

With the following group of faults the message is deleted automatically if the cause disappears.

Thermocouples and resistance thermometers



- Lower range value undershot



- Upper range value overshoot

With the following faults the message appears flashing quickly every second for a duration of 0.2 in the display.

mA; V; thermocouples; mV



- Common mode range (± 3 V) overshoot or undershot (terminal 51 to terminal 52).
- Reference junction defective

Resistance thermometer; teletransmitter







- Terminal 53 open
- Resistance between terminal 53 and 52 > 2.6 kΩ

16 Messages from the self-monitoring · Configuration







Configuration

Entry into the configuration level via parameter setting level (see table 2).

Entrance to the configuration level

  Access can be gained by holding  and  for more than 4 s or

 by entering code figure.

- Adjust decimal point with   or 
The display **CONF** appears
- Switchover of function display with key 
- Changeover of the functions with key 
- Changing the values (addresses) with  and .
- Changeover of input signals from active to passive is described in the Service Instructions.

Return to operator level

- Hold of  and  for more than 4 seconds.

Below the configuration level there are the monitor and test levels. They are only used for service and test purposes and are described in a separate Service Information.

| Function display flashing | Display | Factory setting ¹⁾ | Description of function |
|---------------------------|--|-------------------------------|--|
| 1 | Hr HA Lr LA | | Not for continuous controller |
| 1. | P E b | | Not for continuous controller |
| 2 | Hr HA Lr LA | X | Alarm value 2, max. quiescent current Alarm value 2, max. operating current Alarm value 2, min. quiescent current Alarm value 2, min. operating current Rs 2 |
| 2. | P E b | X | Alarm value 2 of controlled variable Alarm value 2 of control deviation Alarm value 2 of magnitude of the control deviation Rs 2 |
| 3 | IA IF Id | X | Not for continuous controller |
| 3. | 2A 2F 2d | X | Alarm value 2 adjustable Alarm value 2 not adjustable Alarm value 2 not displayed, out of function Signalling of operating mode Rs 2 |
| 4 ²⁾ | I 1 I 2 U 1 U 2 U 3 U 4 L 1 J 1 L 2 J 2 J b S d E 1 E 2 E 3 E 4 | | mA; V; mV Input 1: 0 ... 20 mA linear Input 1: 4 ... 20 mA linear Input 1: 0 ... 1 V linear Input 1: 0,2 ... 1 V linear Input 1: 0 ... 10 V linear Input 1: 2 ... 10 V linear Input 1: thermocouple type L 0 ... 400 °C Input 1: thermocouple type J 0 ... 400 °C Input 1: thermocouple type L 0 ... 1000 °C Input 1: thermocouple type J 0 ... 1200 °C Input 1: thermocouple type K 0 ... 1400 °C Input 1: thermocouple type B 0 ... 1800 °C Input 1: thermocouple type S 0 ... 1800 °C Input 1: thermocouple type D 0 ... 2000 °C Input 1: 0 ... 20 mV linear Input 1: 0 ... 50 mV linear Input 1: 0 ... 100 mV linear Input 1: 0 ... 1000 mV linear |

Table 4 (continuation)

^{1) 2)} see end of table for footnotes

| Function display flashing | Display | Factory setting ¹⁾ | Description of function |
|---------------------------|---|-------------------------------|---|
| 4 ²⁾ | P 2 1 P 2 2 P 2 3 P 2 4 P 3 1 P 3 2 P 3 3 P 3 4 P 4 1 P 4 2 P 4 3 P 4 4 F 1 F 2 d 1 | | Resistance thermometer; teletransmitter Input 1 : Pt 100 2-wire circuit, - 100.0 ... + 100.0 °C Input 1 : Pt 100 2-wire circuit, 0.0 ... + 350.0 °C Input 1 : Pt 100 2-wire circuit, 100.0 ... + 450.0 °C Input 1 : Pt 100 2-wire circuit, - 200.0 ... + 800.0 °C Input 1 : Pt 100 3-wire circuit, - 100.0 ... + 100.0 °C Input 1 : Pt 100 3-wire circuit, 0.0 ... + 350.0 °C Input 1 : Pt 100 3-wire circuit, 100.0 ... + 450.0 °C Input 1 : Pt 100 3-wire circuit, - 200.0 ... + 800.0 °C Input 1 : Pt 100 4-wire circuit, - 100.0 ... + 100.0 °C Input 1 : Pt 100 4-wire circuit, 0.0 ... + 350.0 °C Input 1 : Pt 100 4-wire circuit, 100.0 ... + 450.0 °C Input 1 : Pt 100 4-wire circuit, - 200.0 ... + 800.0 °C Input 1 : teletransmitter 0 ... 1500 Ω Input 1 : teletransmitter 0 ... 150 Ω Factory use only |
| 4. | br h br L | X | Input 1 : reaction in case of sensor break like $x > w$ Input 1 : reaction in case of sensor break like $x < w$ |
| 5 | Value | 0.0 or range start | User range, display for input 1 = 0 % |
| 5. | Value Value | 100.0 or or- span | User range, display for input 1 = 100.0 % On the range selection range start and range end are set automatically. Changes already made can be cancelled by holding ◀ for more than 4 s and tipping ▶. |
| 6 ²⁾ | 1 1 1 2 1 1 u 1 2 u F 1 F 2 | | Input 2: 0 ... 20 mA linear Input 2: 4 ... 20 mA linear Input 2: 0 ... 20 mA linear display in the user range input 1 Input 2: 4 ... 20 mA linear display in the user range input 1 Teletransmitter 0 ... 1500 Ω e.g. for position feedback signal Teletransmitter 0 ... 150 Ω e.g. for position feedback signal |

Table 4 (continuation)¹⁾ ²⁾ see end of table for footnotes

| Function display flashing | Display | Factory setting 1) | Description of function |
|---------------------------|---------|--------------------|---|
| 6. | 1 | X | $w_{int.}: x = c + u \cdot E1; Xw = x - w; \text{display } x$ |
| | 2 | | Additive setpoint feed-in: $x = c + u \cdot E1; Xw = x + c. + u. \cdot E2 - w; \text{display } x$ |
| | 3 | | Auxiliary controlled variable: $x = c + u \cdot E1 + c. + u. \cdot E2; Xw = x - w; \text{display } x$ |
| | 4 | | Ratio display: E1 / E2: $Xw = c + u \cdot E1 - w (c. + u. \cdot E2)$ |
| | 5 | | w_i / w_e Changeover with binary input: $x = c + u \cdot E1; Xw = x - (w_i \text{ oder } w_e);$ |
| | 6 | | $w_{ext.}: x = c + u \cdot E1; Xw = x - w_e$ |
| 7 | Pid | X | Control action PID |
| | PI | | Control action PI |
| | Pd | | Control action Pd |
| | P | | Control action P |
| 7. | 2Cd | | Continuous controller 0...20 mA with or without alarm value |
| | 2CL | | Continuous controller 4...20 mA with or without alarm value |
| 8 | 1 | X | Time range for Tn and Td 1...1999 seconds |
| | 2 | | Time range for Tn and Td 0,1...199,9 minutes |
| 8. | 1 | X | not with continuous controller |
| | 2 | | not with continuous controller |
| 9 | id | X | Inverse controller characteristic, rising manual characteristic |
| | ii | | Inverse controller characteristic, falling manual characteristic |
| | dd | | Direct controller characteristic, rising manual characteristic |
| | di | | Direct controller characteristic, falling manual characteristic |
| 9. | AH | X | Automatic and manual modes |
| | AHt | | Automatic and manual modes, X tracking with manual mode (not with ratio) |
| | A | | Only automatic mode |
| | H | | Only manual mode |
| A | Int | X | Internal reference junction |
| | 0 | | External reference junction 0 °C |
| | 20 | | External reference junction 20 °C |
| | 50 | | External reference junction 50 °C |
| | 60 | | External reference junction 60 °C |
| b. | nb | | Operation mode in case of power supply restoration: as prior to power failure |
| | nH | | Operation mode in case of power supply restoration: manual |

Table 4 (continuation)

1) 2) see end of table for footnotes

20 Configuration

| Function display flashing | Display | Factory setting ¹⁾ | Description of function |
|---------------------------|---------|-------------------------------|---|
| C | . 3 0 | | Baud rate 300 |
| | . 6 0 | | Baud rate 600 |
| | 1.2 0 | | Baud rate 1200 |
| | 2.4 0 | | Baud rate 2400 |
| | 4.8 0 | | Baud rate 4800 |
| | 9.6 0 | X | Baud rate 9600 |
| c. | 1 9.2 | | Baud rate 19200 |
| | X X | 77 | Controller address 01 to FFH, freely selectable, global address = 80H Controller address FD reserved for configuration interface |
| F | Value | | Line balancing to a known line resistance for PT 100 input (see end of table) |
| F. | Value | | Line balancing to test resistor for PT 100 input (see end of table) |
| h. | 0,1 | | X _{sd} 0.1 % with all alarm values |
| | 0,3 | X | X _{sd} 0.3 % with all alarm values |
| | 1,0 | | X _{sd} 1.0 % with all alarm values |
| o | 3 Hr | X | Alarm value 3; max. quiescent current |
| | 3 HA | | Alarm value 3; max. operating current |
| | 3 Lr | | Alarm value 3; min. quiescent current |
| o. | 3 LA | | Alarm value 3; min. operating current |
| | 3 P | | Alarm value 3 of controlled variable |
| | 3 E | X | Alarm value 3 of control deviation |
| O. | 3 b | | Grenzwert 3 vom Betrag der Regelabweichung |
| | 3 A | | Alarm value 3 adjustable |
| | 3 F | X | Alarm value 3 not adjustable |
| | 3 d | | Alarm value not displayed, out of operation |

Table 4 (end)

¹⁾ Factory settings: X: Standard setting; no specification; no specification; Dependent on order

²⁾ By the selection of the measuring range only the ranges that are respectively prepared with hardware bridges and entered in EEPROM will be displayed.

Line balancing with resistance thermometer

The line resistance can be balanced within the range of
0.00 ... 30.00 Ω for the two-wire-circuit
-19.99 ... +30.00 Ω for the three-wire-circuit
(only necessary for unsymmetrical lines).

■ Call function display F or F. at the configuration level ConF.

a. Line balancing to a known line resistance

1. **P** Call function display F
Any resistance value e.g. 3.80 Ω appears in the main display.
2. Set the known line resistance value with **◀** or **▶**.
3. Press **P and ◀** simultaneously for more than 4 s =
Return to the operation level.

or

1. Short circuit the measuring leads at the resistance thermometer.
2. Press HA key for more than 3 s.
Balancing is made automatically.
3. Cancel short circuit of the measuring leads at the resistance thermometer.
4. Press **P and ▶** simultaneously for more than 4 s =
Return to the operation level.

b. Line balancing with test resistor

1. Connect test resistor in the place of resistance thermometer.
2. Call function display F, with **P**
A temperature specification in $^{\circ}\text{C}$ appears in the main display.
3. Using **▶** or **◀**, set the temperature specification to the known value of the test resistor.
4. Press **P and ◀** simultaneously for more than 4 s =
Return to the operation level.

Maintenance

Service

The unit requires no maintenance. Relays are subject to wear, depending on the switching frequency and load.

Caution

Any interruption of the protective connector inside the unit or of the protective conductor outside the unit or disconnection of the protective ground terminal is likely to make the apparatus dangerous. Intentional interruption is prohibited.

When the apparatus is connected to its supply, terminals may be live, and the opening of covers or removal of parts except those to which access can be gained by hand is likely to expose live parts. The apparatus shall be disconnected from all voltage sources before it is opened for any adjustment, replacement, maintenance or repair. Any adjustment, maintenance and repair of the opened apparatus under voltage shall be avoided as far as possible and, if inevitable, shall be carried out by a person who is aware of the hazard involved.

Capacitors inside the apparatus may still be charged even if the apparatus has been disconnected from all voltage sources.

 No high voltage test may be carried out without thorough knowledge.

Faults and unusual stress

Caution

Whenever it is likely that the protection has been impaired, the apparatus shall be made inoperative and be secured against any unintended operation.

It must be assumed that the protection has been impaired when

- the apparatus has visible signs of damage,
- the apparatus no longer functions,
- the apparatus has been stored in unfavorable conditions for a long time,
- the apparatus has been subject to adverse transport conditions.

Packing instructions

If the original packing is no longer available, the unit must be wrapped in an insulating air foil or corrugated board and packed in a sufficiently large crate lined with shock absorbing material (foamed material or similar) for the transportation. The thickness of cushioning must be adapted to the weight of the unit and to the mode of transport. The crate must be labeled "Fragile".

For overseas shipment the unit must additionally be sealed airtight in 0.2 mm thick polyethylene together with a desiccant (e.g. silica gel). The quantity of the desiccant must correspond to the packing volume and the probable duration of transportation (at least 3 months). Furthermore, for this type of shipment the crate should be lined with a double layer of kraft paper.

Spare parts

Spare parts are given in the following Spare Parts List. When ordering spare parts please quote the designation and the Catalog No. of the spare part. Always state the Serial No. inscribed on the rating plate as well as the Order No.

The designations in the Spare Parts List, the confirmation of order, the delivery note and the invoice may differ from the function-related names given to these parts in this Operating Manual.

The Catalog No. is the sole criterion.

| Object | Catalog No. |
|---------------------------|--------------------|
| Indicator module | 61404-4-0801763 |
| Cover foil, printed, gray | 61404-4-0801764 |
| black | 61404-4-0801765 |
| Interface cover | 61404-4-0801766 |
| Inscription sheet | 61405-4-0801767 |
| Connection circuit board | |
| with for multiplugs | 61404-4-0801768 |
| with blade-type | 61404-4-0801769 |
| Cover plate printed, | |
| for multiplugs | 61404-4-0801803 |
| for blade-type terminals | 61404-4-0801804 |
| Holder | 61404-4-0801772 |
| Case cover | 61404-4-0801773 |
| Coding pin | 61404-4-0801774 |

(continuation on page 24)

| Object | Catalog No. |
|---------------------------------|--------------------|
| Power supply unit and output | |
| 230 V with 1 relay (Rs2) | 61404-4-0801808 |
| 230 V without relay | 61404-4-0801805 |
| 115 V with 1 relay (Rs2) | 61404-4-0801810 |
| 115 V without relay | 61404-4-0801807 |
| 24 V with 1 relay (Rs2) | 61404-4-0801809 |
| 24 V without relay | 61404-4-0801806 |
| Screw terminals | 61005-4-0877414 |
| Female tab connectors | |
| (1 set = 15 pcs.) | 61004-4-0381527 |
| Plug-on screw terminals | |
| (1 set = 15 pcs.) | 61404-4-0342910 |
| Serial interface | 61429-4-0743200 |
| Binary I/O module, | |
| Transistor output 24 V DC/50 mA | 61429-4-0743521 |
| Triac output 230 V AC, 1 A | 61429-4-0743701 |

Appendix

Technical data

Inputs

1st input (E1) for mA, V, mV according to terminal assignment, optionally:

resistance measurement in 2-, 3- or 4-wire circuit;
Pt 100 or teletransmitter according to terminal assignment

2nd input (E2) for auxiliary variable connection or external setpoint for mA,

optionally:

teletransmitter; with step controller, also for position feedback.

All inputs can be weighted.

Current

0(4)...20 mA, $R_e = 12 \Omega$ for input 1; $R_e = 50 \Omega$ for input 2, admissible interference voltage (peak-to-peak) ± 100 mV, 50 Hz, symmetrical

Voltage

0 (0.2)...1 V and 0 (2)...10 V

Input resistance 84 k Ω

Admissible interference voltage (peak-to-peak):
 $\pm 10\%$ in the 50 Hz range, at input symmetrical

Thermocouple / mV

Ranges:

| | |
|---------------------|---------------------|
| 0... 400 °C type L | 0... 1800 °C type S |
| 0... 400 °C type J | 0... 2000 °C type D |
| 0... 900 °C type L | 0... 20 mV |
| 0... 1200 °C type J | 0... 50 mV |
| 0... 1400 °C type K | 0... 100 mV |
| 0... 1800 °C type B | |

Reference junction built-in, external configurable

0 °C, 20 °C, 50 °C and 60 °C

Measuring deviation ± 2 °C, ± 1 °C / 10 °C ambient temperature change

Thermocouple break monitoring

Reaction as actual value > setpoint ($x < w$ configurable)

Admissible interference voltage (peak-to-peak) 100 mV, 50 Hz, symmetrical

Resistance thermometer

Ranges:

| | |
|---------------------------|---------------------------|
| -100...+100 °C Pt 100 IEC | 100...+450 °C Pt 100 IEC |
| 0...+350 °C Pt 100 IEC | -200...+800 °C Pt 100 IEC |

2-wire circuit; 3- or 4-wire circuit configurable

Sensor measuring current approx. 2 mA

Digital lead balancing with 2-wire circuit at the unit

Measuring circuit monitoring

Break: reaction as $x > w$ ($x < w$ configurable)

Short-circuit: reaction as $x < w$

Teletransmitter

0... 150 Ω

0... 1500 Ω

Admissible interference voltage: 200 mV (peak-to-peak), 50 Hz

Ratio

(0...2): 1; reference variable input (E2), sequential input (E1)

0(4)...20 mA; ratio = $E1 / E2$
(only with Suppl. No. 337)

Binary

1 binary input for setpoint transfer w_1 - w_6 ,
see binary I/O module

Common data

Measuring deviation

$\pm 0.2\%$ of basic measuring range; $\pm 0.1\%$ of measured value;
 ± 1 digit

Measuring range resolution

$\leq 0.025\%$ ($\cong 4000$ digits)

Nonlinearity (sensor)

$\leq 0.1\%$; considerable deviations with type S below $300\text{ }^{\circ}\text{C}$
and with type B below $900\text{ }^{\circ}\text{C}$

Admissible common-mode voltage

$\leq \pm 3\text{ V}$ between two measuring inputs and symmetrical
mass

Output

Relay

1 or 2 relays with changeover contact (floating)

Spark quenching integrated

Max. 250 V (eff)

Max. 1 A with $\cos \varphi \approx 1$

Max. 0.5 A with $\cos \varphi \cong 0.7$

Binary

1 transistor output or 1 Triac output for alarm signalling,
see binary I/O module

Analogue

$0(4)\dots 20\text{ mA}$, $R_o \leq 500\ \Omega$

Control function

for controlling thyristor power controllers or pneumatic final
control elements

26 Technical data

Control action

P, PD, PI, PID (with integral action limitation)

Reverse action characteristic; direct action characteristic
configurable

Common data

Self-parameter setting

Determine requested parameters in closed loop-control out
of a setpoint step-change

Proportional area X_p

$0\dots 1850\%$

Reset time T_n

$1\text{ s}\dots 199.9\text{ min}$ in 2 ranges

Derivative action time T_d

$1\text{ s}\dots 199.9\text{ min}$ in 2 ranges

Derivative action amplification V_D : 4

Control station

1 digital display

for x, w, y, control deviation xw,

4-digit alarm values, max. reading $-1999\dots +7999$

1 display for variable name

7-segment display, LED, red, height 13 mm

4 keys

H/A

Manual / automatic mode

◀ and ▶

More /less, for setting displayed variables

P

Display changeover and access to
parameter level

Alarm signalling

Depending on the respective function, monitoring of controlled variable x , control deviation x_w or modulus x_w .

Switching action max. or min. NC or NO contact operation, configurable.

Setting ranges $\pm 0 \dots 100\%$ or physical units according to user range.

Binary I/O module (option)

Can be retrofitted as accessory at the rear of the unit instead of the serial interface.

Binary input

For setpoint transfer w_i, w_e

Circuit to DIN 19 240 for active sources:

0 = $-3 \dots +5$ V-

1 = $13 \dots 30$ V-

Binary output

As additional alarm signalling (NC contact) for x_w max., x max. or x_w modulus

1 transistor output with opto-electronic coupler, electrically isolated, floating

Max. 35 V DC, max. 50 mA

1 = conduction transistor

0 = inhibited transistor (high impedance)

Leakage current $\leq 10 \mu\text{A}$ for 30 V,

voltage drop ≤ 1.8 V for 10 mA

Optionally:

1 Triac output with opto-electronic coupler, electrically isolated, floating

Switching voltage range $20 \dots 250$ V AC

Rated-load voltage 230 V AC $\cos \varphi = 0.7$ without additional circuit

Load current max. 1 A at 25°C , linear reduction to 0.5 A at 50°C , integrated fuse protection: integrated fuse F 1.0

Serial interface (option)

Can be retrofitted as accessory at the rear of the unit instead of the binary I/O module.

With and without electrical isolation (switchable)

RS-485 without electrical isolation

Up to 10 bus subscribers with internal power supply

RS-485 with electrical isolation

Max. 32 bus subscribers, external power supply 6 V DC $\pm 5\%$ required (average $I = 20$ mA, short-term peak value $i = 150$ mA).

The use of one TZG 6 for instance is sufficient for 11 bus subscribers.

Bus length

Max. 1200 m, without termination resistor

RS-232C

Optionally separate interface adapter available as accessory (cable with transformer)

Telegram format

to DIN 19 245 (PROFIBUS)

Power supply

Alternating voltage

230 V (187 ... 253 V), 47 ... 63 Hz

115 V (98 ... 126 V), 47 ... 63 Hz

24 V (20 ... 27 V), 47 ... 63 Hz

Power consumption 4.5 VA

Mains buffering

≥ 20 ms, $U_{nom} = 10\%$, -15%

Fuses

The controller is equipped with an integrated temperature fuse. No additional fuses required.

General technical and safety data

Climatic capabilities

Climatic category KWE
to DIN 40 040

Ambient temperature
 $0 \dots +50$ °C

Transportation and storage temperature
 $-25 \dots +65$ °C

Relative humidity
 $\leq 75\%$ in annual average,
temporarily 95% ;
occasional and slight condensation

Mechanical stress

Tested to DIN IEC 68 Part 2-27 and 68-2-6
Shock $30g / 18$ ms;
vibration $2g / 0.15$ mm / $5 \dots 150$ Hz

Electromagnetic compatibility

Emission (radio interference suppression)
Limit value class B is fulfilled for general approval to German
Federal Postal Service order 1046/84.

Immunity to interferences
to IEC 801/DIN VDE 0843;
industrial standard to NAMUR

Electrical safety

Tested to DIN VDE 0411 / 10.73, class of protection 1
Clearance and creepage distance to DIN VDE 0411 and 0110/1.89

Overvoltage category: III

Degree of contamination: 2

Degree of protection to DIN 40 050

Front IP 64

Rear IP 40

Blade-type terminal IP 00

Plug-on screw terminals IP 20

Coded multi-plug IP 20

Connection, case and mounting

Dimensions

see dimensional drawing (Fig. 2)

Electrical connections

Tab connector to DIN 46 244, $A 6.3 \times 0.8$ or $A 2.8 \times 0.8$ or pole
 2.4×0.8 , plug-in screw terminals available as accessory (for
solid or stranded wire up to 1.5 mm²)

Tab connector $A 6.3 \times 0.8$ for mains connection

Optionally:

coded multi-plug with screw terminals

Colour of frontal panel

Black,

optionally pebble grey RAL 7032. Front frame black

Weight

Approx. 1 kg

Mounting

Note mechanical stress and climatic capabilities

Mounting position

Arbitrary, independent of function

Safety-certified controllers

Temperature controller

to DIN 3440 (07. 1984). With TÜV expertise.

The apparatus may be used as a temperature controller together with appropriate sensors for water, oil, air and flue gas for setpoint value settings from – 200 °C to 2000 °C and ambient temperatures up to 50 °C. Only temperature sensors complying with DIN 3440 may be connected.

Model State Suppl. No. 750
Documentation VdTÜV Instructions on temperature
H&B Documentation No. 48 / 61-11 DIN

Water-level controller

to VdTÜV Instructions 100 / 1 (03. 1986).

With TÜV identification.

The apparatus may be used as continuous controller for water level in high-pressure steam boilers in stationary boiler installations.

The controller may only be connected to sensors or transmitters sending standardized signals and tested to VdTÜV Instructions on water level 100 / 1.

Model State Suppl. No. 751
Documentation VdTÜV Instructions on Water-level 350
(06. 1990)
H&B Documentation No. 48 / 61-12 TÜV

Germanischer Lloyd

Controller to rules and type test.

On the basis of this certificate, Bitric P ist suited for unconditional application within the Rules of Germanischer Lloyd. The apparatus may thus be used without restrictions on sea-going and inland waterway vessels as well as offshore structures classed with GL.

Model State Suppl. No. 752
Documentation GL certificate 65 260 HH 4 / 93
H&B-Dokumentation No. 48 / 61-13 GL

Ordering matrix

| | | | |
|---|--|-----------------|-----------------|
| Controller for industry and process engineering Bitric P | Alarm signalling unit | 6 1 4 2 1 - 0 - | |
| | On/off controller Z | 6 1 4 2 2 - 0 - | |
| | Step controller D | 6 1 4 2 3 - 0 - | |
| | Positioner | 6 1 4 2 3 - 0 - | |
| | Continuous controller K | 6 1 4 2 4 - 0 - | |
| Power supply | | | □ □ □ □ □ □ □ □ |
| 230 V AC | | 1 | |
| 115 V AC | | 2 | |
| 24 V AC | | 3 | |
| Input E1 | | | □ □ □ □ □ □ □ □ |
| Measuring ranges for mA, V, mV 0... 20 mA ¹⁾ | | 100 | |
| Measuring ranges for Ω -100... +100 °C Pt 100 IEC, 2-wire circuit ²⁾ | | 001 | |
| Control function | | | □ □ □ □ □ □ □ □ |
| Alarm signalling unit | 1 max. alarm signal | 10 | |
| | 1 min. and 1 max. alarm signal | 20 | |
| On/off controller Z1 | 1 output (for on/off control) | 30 | |
| | 1 output and 1 x_w max. alarm signal (for on/off control with additional alarm signal or high/low/off control) | 40 | |
| On/off controller Z2 | 2 outputs (for heating/off/cooling control) | 50 | |
| Step controller D | 2 relays with converters (for closed-loop control with motor-operated actuators) | 60 | |
| Positioner | 2 relays with converters | 90 | |
| Continuous controller | 1 analogue output | 70 | |
| | 1 analogue output and 1 x_w max. alarm signal | 80 | |
| Connections | | | □ □ □ □ □ □ □ □ |
| Blade-type terminal | | 1 | |
| Multi-plug with screw terminals | | 2 | |
| Catalogue No. | | 6 1 4 2 - 0 - | □ □ □ □ □ □ □ □ |
| For options add a supplementary number (Suppl. No.) to the catalogue number. | | | |
| 1) Other measuring ranges configurable for mA, V, mV | | | |
| 2) Other measuring ranges configurable for Ω | | | |

Examples for applications

Setpoint station

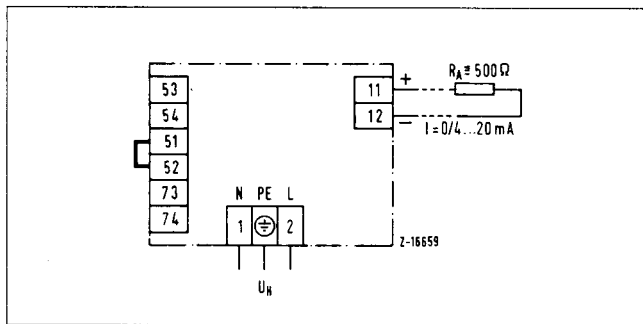

Fig. A1 Bitric P as current transmitter

The Bitric P can also be utilized as set point station (current transmitter) 0/4...20 mA. For this, are the following settings necessary (see Tables 2 and 4):

- Proportional range = 100 %
- Load point $h = 0$ %
- Control characteristic = P
- Actual value = 0
- By thermoelectric couple input, the external reference point is to be set to 0 °C (see section 5, configuration, function display "A").
- Setting the output current from 0... 100 % by changing the set value "S"
- Take-over time on a new value is determined via T_n .

Hand Station, continuous

The operation corresponds to the "Manual operating mode". The setpoint display is switched off.

On input 1 any measured value whatever can be displayed.

The following setting on the configuration level is required:

- Set function display 9. to "H".

Hand/automatic station, continuous

For connection diagram, see Fig. A2.

The output signal of a higher-level controller is applied to the signal input.

In automatic operating mode, the output follows the input without any delay.

The switchover from "Automatic" to "Manual" takes place bumpless.

The last automatic signal is accepted as manual signal. When switching back from "Manual" to "Automatic" the resulting jump is delayed by T_n .

The operating mode can be signalled with the relay Rs2.

The following settings on the configuration level are required:

1. Control behaviour = P; function display 7 to "P"
2. Controller characteristic = rising; function display 9 to "dd"
3. Signalling of the operating mode; function display 3. to "2d"
4. Proportional range $P = 100$ %
5. Operating point $h = 0$ %
6. Setpoint limits $H = L = 0$ %

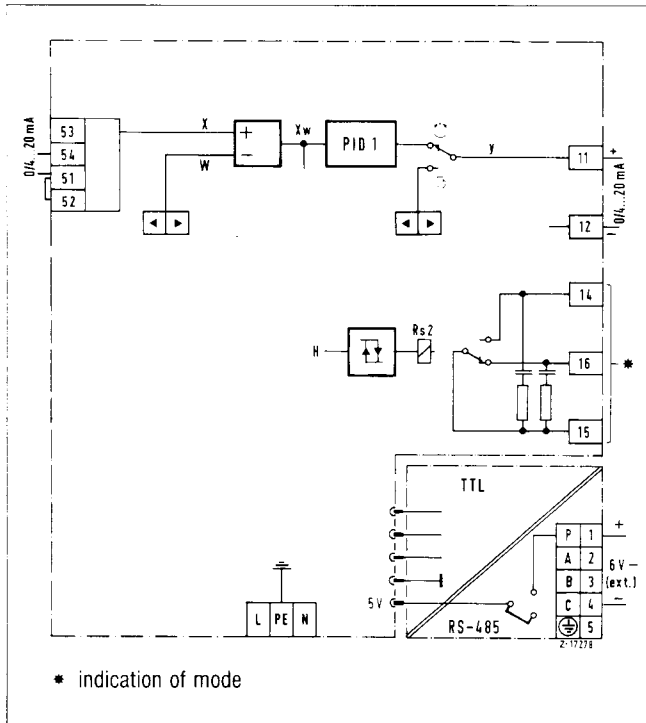

Fig. A2 Manual/automatic station

Averaging unit

Having been parameterized correspondingly, the Bitric P with 2 mA inputs can be used for the average value determination of 2 mA input signals (0/4...20 mA).

The average value is available at the output as 0(4)...20 mA signal.

The following settings on the configuration level are required:

1. Controller characteristic = direct, function display 9 to "d"
2. External setpoint = function display 6., setting 3
3. Setpoint limits $H = L = 0\%$
4. Control behaviour = P; function display 7 to "P"
5. Proportional range $P = 200\%$
6. Operating point $h = 0\%$
7. Operating mode "Automatic"

The average value signal can be delayed. The delay time is set with "n" (T_n).

The sum of both inputs is displayed as x or resp. x_w and the average value as y .

Subject to technical changes.

This technical documentation is protected by copyright. Translating, photocopying and disseminating it in any form whatsoever - even editings or excerpts thereof - especially as reprint, photomechanical or electronic reproduction or storage on data processing systems or networks is not allowed without the permission of the copyright owner and non-compliance will lead to both civil and criminal prosecution.



ABB Automation Products GmbH
Höselers Platz 2, D-42579 Heiligenhaus
Tel. +49(0)20 56 12 - 51 81
Fax. +49(0)20 56 12 - 50 81
<http://www.abb.com>

Subject to technical changes.
Printed in the Fed. Rep. of Germany
42/61-41 EN Rev. 3.0
Edition 04.01