

MEDIUM VOLTAGE PRODUCT

# AdvaSense™ KEVA C

Indoor voltage sensors for Cellpack separable connectors



01 Resistive divider principle

02 IED and sensor

Parameters for Application	Value
Rated primary voltage of application	up to 24 kV

Sensor Parameters	Value
Rated primary voltage, $U_{pn}/U_{pr}$	22/ $\sqrt{3}$ kV
Highest voltage for equipment, $U_m$	24 kV
Rated power frequency withstand voltage	50 kV
Rated lightning impulse withstand voltage	125 kV
Rated transformation ratio, $K_n/K_r$ for voltage measurement	10 000:1
Voltage accuracy class	0.5/3P
Length of cable	2.2; 5 m

**Sensor principles**

AdvaSense™ voltage sensors (Electronic voltage transformers according to IEC 60044-7 and low-power passive voltage transformers according to IEC 61869-11 standards) offer an alternative way of making the voltage measurement needed for the protection and monitoring of medium voltage power systems. Sensors based on alternative principles have been introduced as successors to conventional instrument transformers in order to significantly reduce size, increase safety, and to provide greater rating standardization and a wider functionality range. These well known principles can only be fully utilized in combination with versatile electronic relays.

**Sensor characteristics**

Construction of ABB’s AdvaSense™ voltage sensors is done without the use of a ferromagnetic core. This fact results in several important benefits for the user and the application.

The main benefit is that the behavior of the sensor is not influenced by non-linearity and width of hysteresis curve, which results in a highly accurate and linear response over a wide dynamic range of measured quantities. A linear and highly accurate sensor characteristic in the full operating range enables the combination of metering and protection classes in one device.

**Voltage sensor**

Voltage measurement in KEVA C sensors is based on the resistive divider principle. The output voltage is directly proportional to the input voltage:

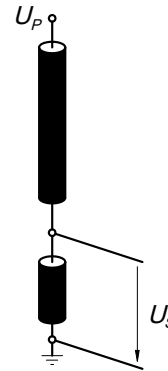

$$U_s = \frac{R_2}{R_1 + R_2} U_p$$

01

In all cases, the transmitted output signal reproduces the actual waveform of the primary voltage signal.

**Protection and control IEDs (Intelligent Electronic Devices)**

Protection and control IEDs incorporate the functions of a traditional relay, as well as allow new additional functions. The information transmitted from the sensors to the IED is very accurate, providing the possibility of versatile relay functionality.

However, the IED must be able to operate with sufficient accuracy at a sensor’s low input signal level. Modern IEDs (such as ABB’s 615 series relays) are designed for such sensor use.

Modern digital apparatuses (microprocessor based relays) allow protection and measurement functions to be combined. They fully support voltage sensing realized by the single sensor with double the accuracy class designation (e.g.: voltage sensing with combined accuracy class 0.5/3P).

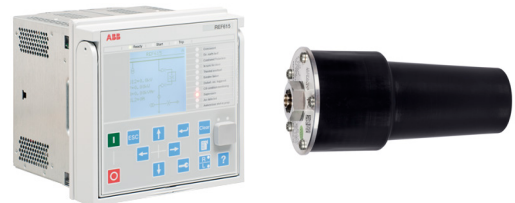



02

03 KEVA C application  
 04 Combined accuracy class



03

Sensor type designation	Metal coated (conductive surface)	Picture
KEVA 24 C10 KEVA 24 C25	✘	
KEVA 24 C10c KEVA 24 C25c	✔	

Tab. 1. Sensor design variants (with and without conductive surface)

Sensor type designation	Cable connector		
	Manufacturer	Type	Connecting screw for sensor
KEVA 24 C10 KEVA 24 C10c	Cellpack	CTS-S 630A 24kV	M16
KEVA 24 C25 KEVA 24 C25c	Cellpack	CTS 630A 24kV	M16
		CTKS 630A 24kV	
		CTKSA 630A 24kV	

Tab. 2. Sensor variants and use in cable connectors

**Note: For use in alternative cable connectors please contact ABB.**

**Differences between Sensors and Instrument Transformers**

There are some noticeable differences between Sensors and conventional Instrument Transformers:

**Linearity**

Due to the absence of a ferromagnetic core the sensor has a linear response over a very wide primary voltage range.

Example of voltage measurement range for metering accuracy class 0.5 and protection accuracy class 3P:

The accuracy limits are described on the graph below.

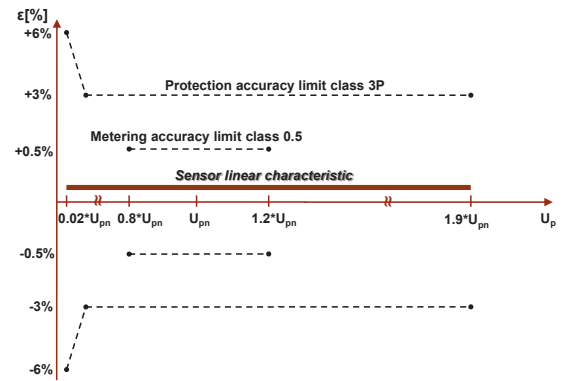

04

**Rated parameters**

Because the sensors are highly linear within a very wide range of voltages, the same single sensor can be used for the various rated voltages associated with each specific application up to the specified maximum voltage for equipment. There is no need to specify other parameters such as burden etc. since they are standard over the defined range. To achieve the correct function of the protection and control IED, the selected rated voltage as well as the rated transformation ratio, must be properly set into the IED.

**Correction factors**

The amplitude and phase error of a voltage sensor is, in practice, constant and independent of the primary voltage. Due to this fact it is an inherent and constant property of each sensor and it is not considered as unpredictable and influenced error. Hence, it can be easily corrected in the IED by using appropriate correction factors, stated separately for every sensor.

Values of the correction factors for the amplitude and phase error of a voltage sensor are mentioned on the sensor label (for more information please refer to Instructions for installation, use and maintenance) and should be uploaded without any modification into the IED before the sensors are put into operation (please check available correction in the IED manual). To achieve required accuracy classes it is recommended to use both correction factors: amplitude correction factor ( $aU/CF_u$ ) and phase error correction factor ( $pU/ \varphi_{0.cor}$ ) of a voltage sensor.

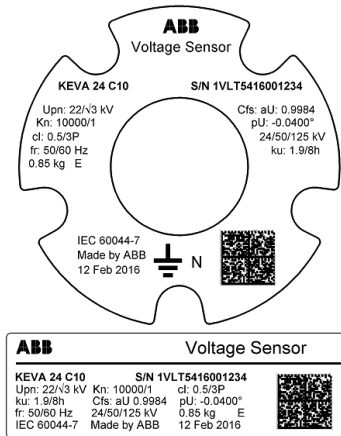
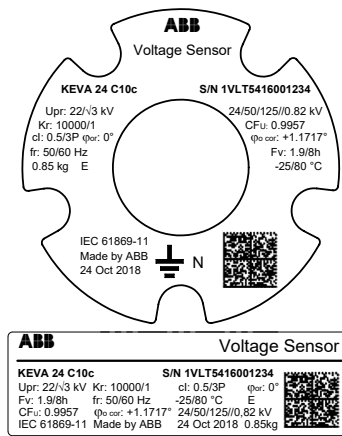
—  
05—  
06—  
05 Example of a sensor label (IEC 60044-7)—  
06 Example of a sensor label (IEC 61869-11)—  
07 Connector RJ45 (IEC 60044-7)—  
08 Connector RJ45 (IEC 61869-11)

### Secondary cables

The sensor is equipped with a cable for connection with the IED. The cable connector is type RJ45. The sensor accuracy classes are verified up to the connector, i.e. considering also its secondary cable. These cables are intended to be connected directly to the IED, and subsequently neither burden calculation nor secondary wiring is needed. Every sensor is therefore accuracy tested when equipped with its own cable and connector.

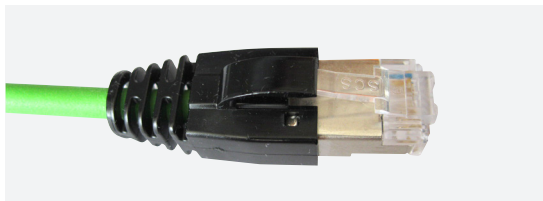
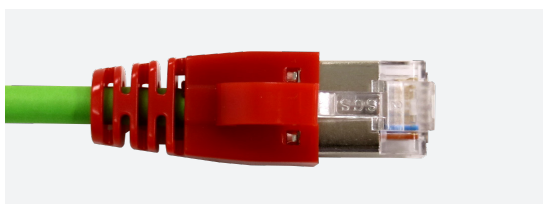
—  
07—  
08

### Connector adapters

To provide connectivity between a sensor with a RJ45 cable connector and IEDs with Twin-BNC connectors a group of adapters were designed. To provide connectivity between current and voltage sensors with RJ45 cable connectors and IEDs with RJ45 connector the coupling adapter was designed.

The use of connector or coupling adapters has no influence on the current and/or voltage signal and accuracy of the sensor with the cable.

For more information about connector adapters and coupling adapter refer to Doc. No. 1VLC000710 - Sensor accessories.

### Standards

- IEC 60044-7 (1999-12) Instrument transformers - Part 7: Electronic voltage transformers
- IEC 61869-11 (2017-12) Instrument transformers - Part 11: Additional requirements for low-power passive voltage transformers
- HD 629.1 S2 (02/2006) + A1 (09/2008) Table 10, test requirements

### Highest voltage for equipment and test voltages

- Highest voltage for equipment,  $U_m$ : 24 kV
- Rated power frequency test voltage: 50 kV
- Rated lightning impulse test voltage: 125 kV

### Insulation requirements for secondary terminals according to IEC 61869-11

- Power frequency voltage withstand capability: 0.82 kV
- Impulse voltage withstand capability: 1.5 kV 1.2/50  $\mu$ s

### Voltage sensor, rated values

- Rated primary voltage,  $U_{pn}/U_{pr}$ : 22/√3 kV
- Rated frequency,  $f_r$ : 50/60 Hz
- Accuracy class: 0.5/3P
- Rated burden,  $R_{br}$ :
  - IEC 60044-7 10 M $\Omega$
  - IEC 61869-11 2 M $\Omega$ ; 50 pF
- Rated transformation ratio,  $K_n/K_r$ : 10 000:1
- Rated voltage factor,  $k_u/F_v$ : 1.9/8h

### Temperature category

- Operation: -25°C/+80°C
- Transport and storage: -40°C/+80°C

### Cable

- Length: 2.2; 5 m
- Connector: RJ45 (CAT-6)
- Grounding wire length: 0.5 m

Sensor type	Supported type of cable connector		Cable length	Sensor ordering code	
	Manufacturer	Type		IEC 60044-7	IEC 61869-11
KEVA 24 C10	Cellpack	CTS-S 630A 24kV	2.2 m	1VL5400061V0101	1VL5400061V1101
			5 m	1VL5400061V0103	1VL5400061V1103
KEVA 24 C10c	Cellpack	CTS-S 630A 24kV	2.2 m	1VL5400061V0201	1VL5400061V1201
			5 m	1VL5400061V0203	1VL5400061V1203
KEVA 24 C25	Cellpack	CTS 630A 24kV	2.2 m	1VL5400079V0101	1VL5400079V1101
			5 m	1VL5400079V0103	1VL5400079V1103
KEVA 24 C25c	Cellpack	CTKS 630A 24kV CTKSA 630A 24kV	2.2 m	1VL5400079V0201	1VL5400079V1201
			5 m	1VL5400079V0203	1VL5400079V1203

Tab. 3. Sensor overview.

**Note:** For use in alternative cable connectors please contact ABB.

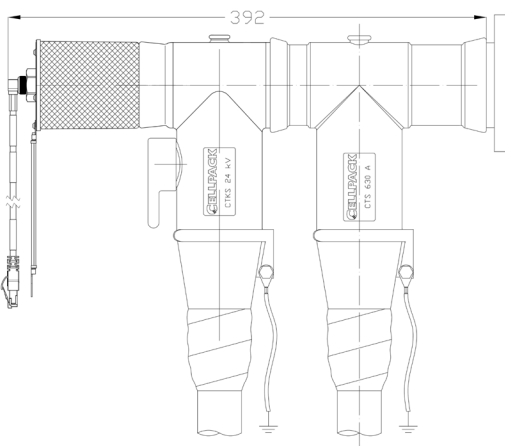

—  
08 CTS 630 A 24 kV  
+ CTKS 630 A 24 kV  
+ KEVA 24 C25(c)

—  
09 CTS 630 A 24 kV  
+ CTKSA 630 A 24 kV  
+ KEVA 24 C25(c)

—  
10 CTS-S 630 A 24 kV  
+ KEVA 24 C10(c)

—  
08

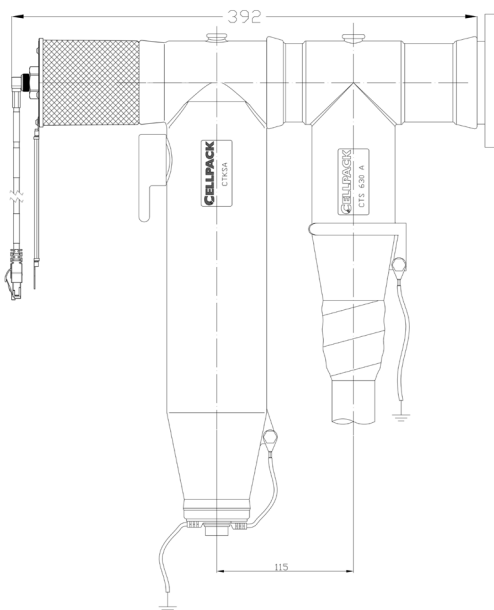

—  
09

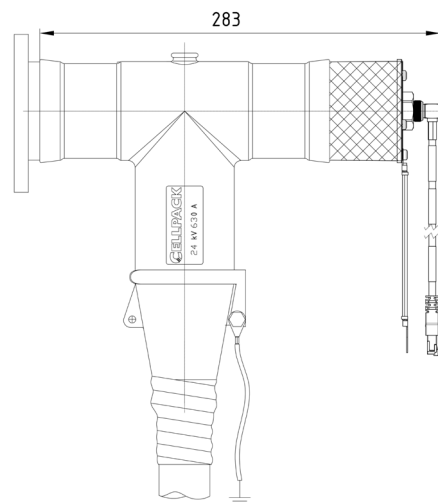

—  
10

### Dimensional drawing

KEVA 24 C10 and KEVA 24 C10c

Outline drawing number: 2RKA015654

Weight: 0.85 kg

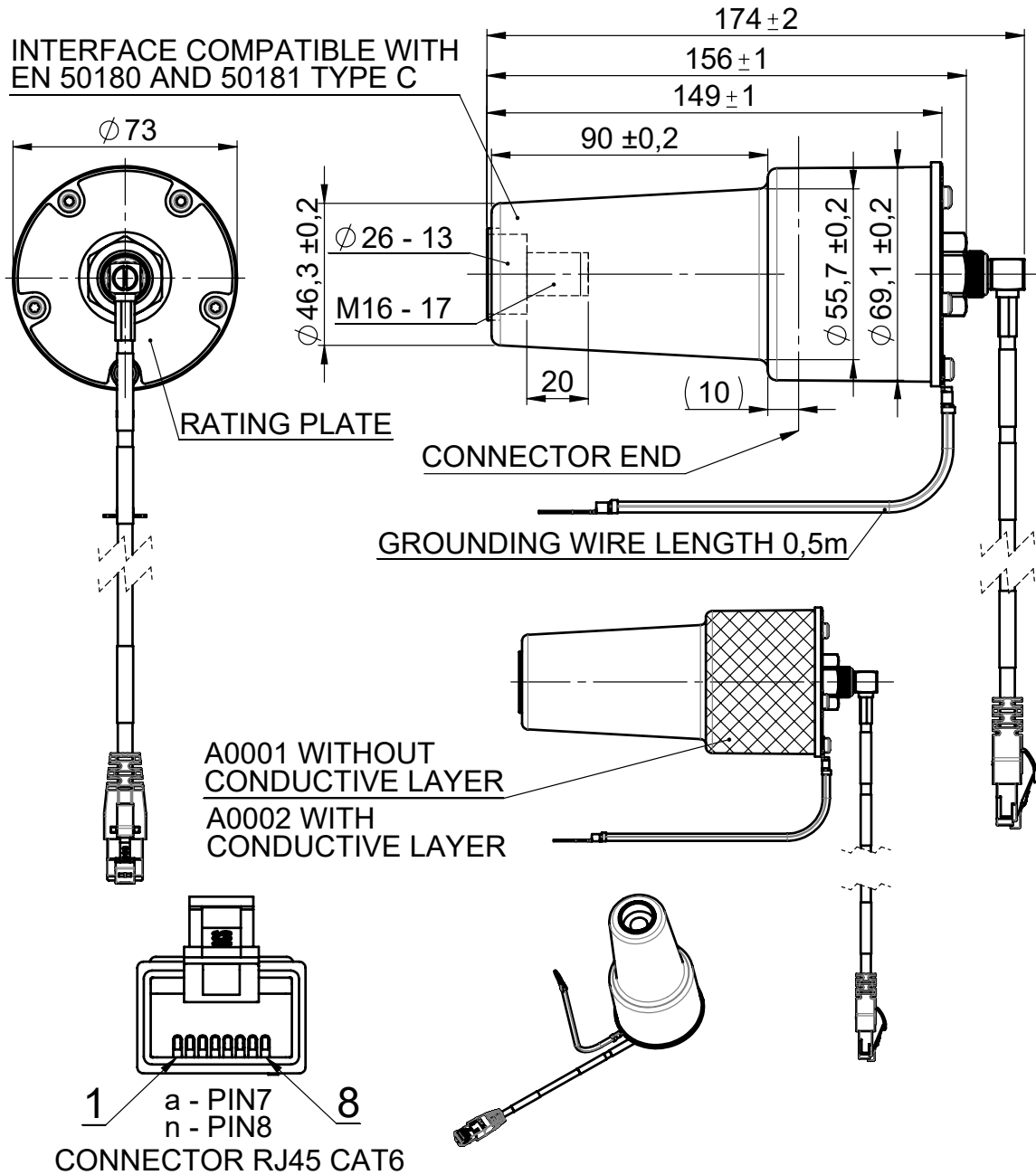

**Dimensional drawing**

KEVA 24 C25 and KEVA 24 C25c

Outline drawing number: 2RKA019522

Weight: 0.85 kg

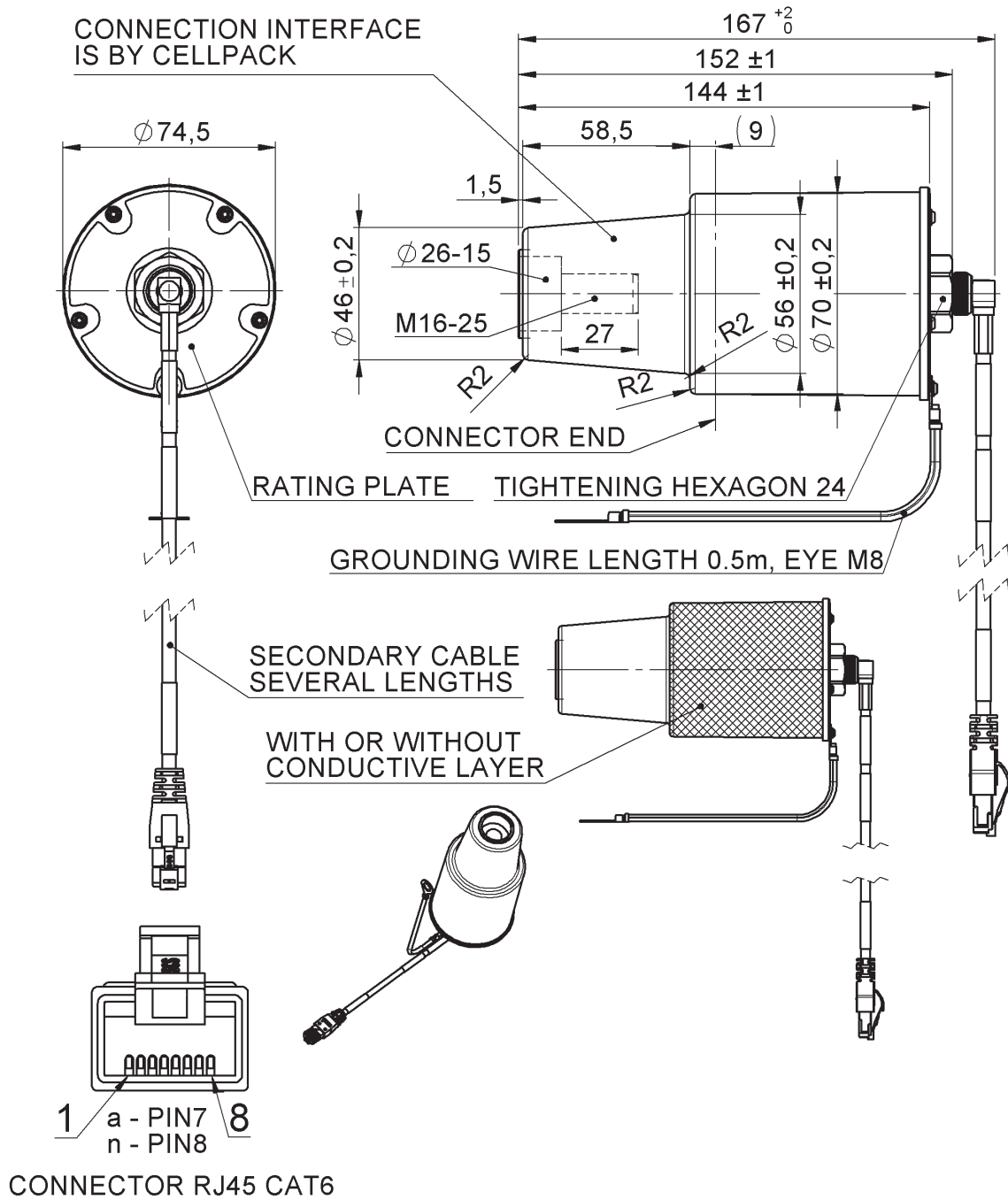

---

CONTACT US

**ABB s.r.o.**

ELDS Brno  
Videnska 117, 619 00 Brno,  
Czech Republic

Tel.: +420 547 152 082

+420 547 152 854

Fax: +420 547 152 626

E-mail: kontakt@cz.abb.com

**[www.abb.com](http://www.abb.com)**

---

NOTE

We reserve the right to make technical changes or modify the contents of this document without prior notice. With regard to purchase orders, the agreed particulars shall prevail. ABB does not accept any responsibility whatsoever for potential errors or possible lack of information in this document.

We reserve all rights in this document and in the subject matter and illustrations contained therein. Any reproduction, disclosure to third parties or utilization of its contents - in whole or in parts - is forbidden without prior written consent of ABB.

Copyright© 2023 ABB  
All rights reserved