



Kalo

Attraction in simplicity



- Thin cover and frame – just 7 mm
- Backlight with blue LED lighting
- Smooth switching
- High quality materials for contacts
- Included fasteners for furniture or boards
- Designed for mounting on uneven surfaces



Kalo

Attraction in simplicity

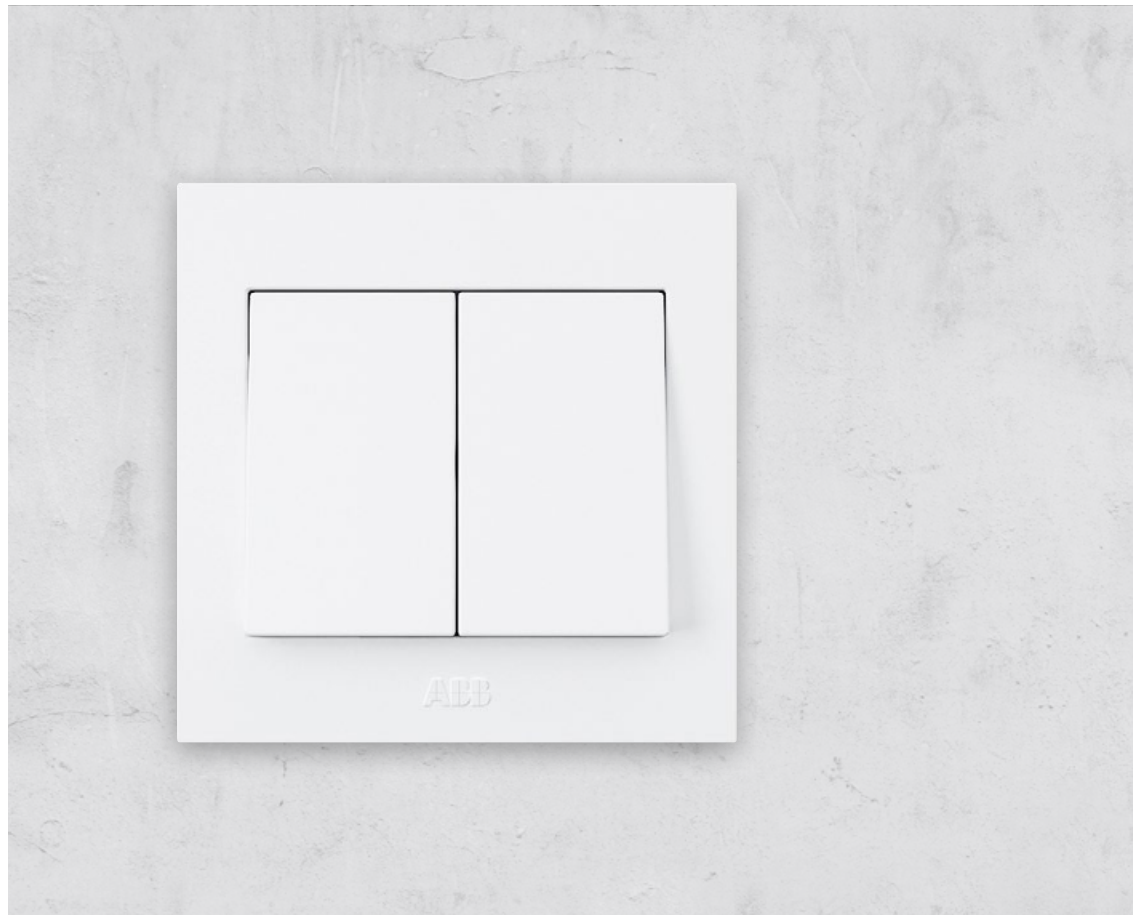

The elegance of the Kalo design series lies in its simplicity and purity. The neutral white design perfectly complements any interior, with a blue LED backlight which illuminates itself in the dark. Now you can fully devote yourself to interior design and fitting – because the Kalo design line is affordable and at the same time branded. ABB electrical installation.

Kalo

Your First Choice

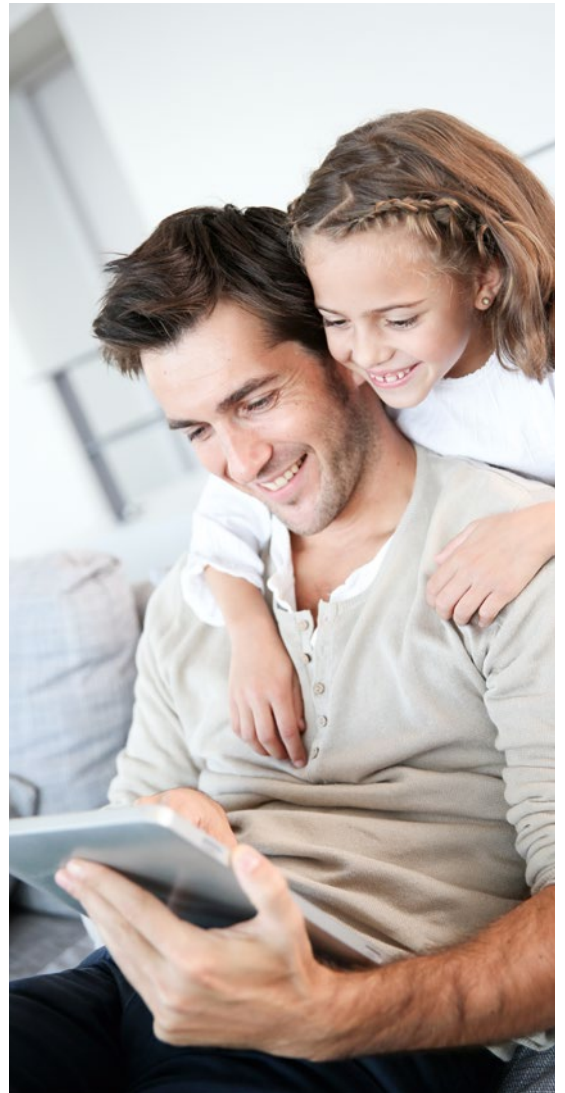
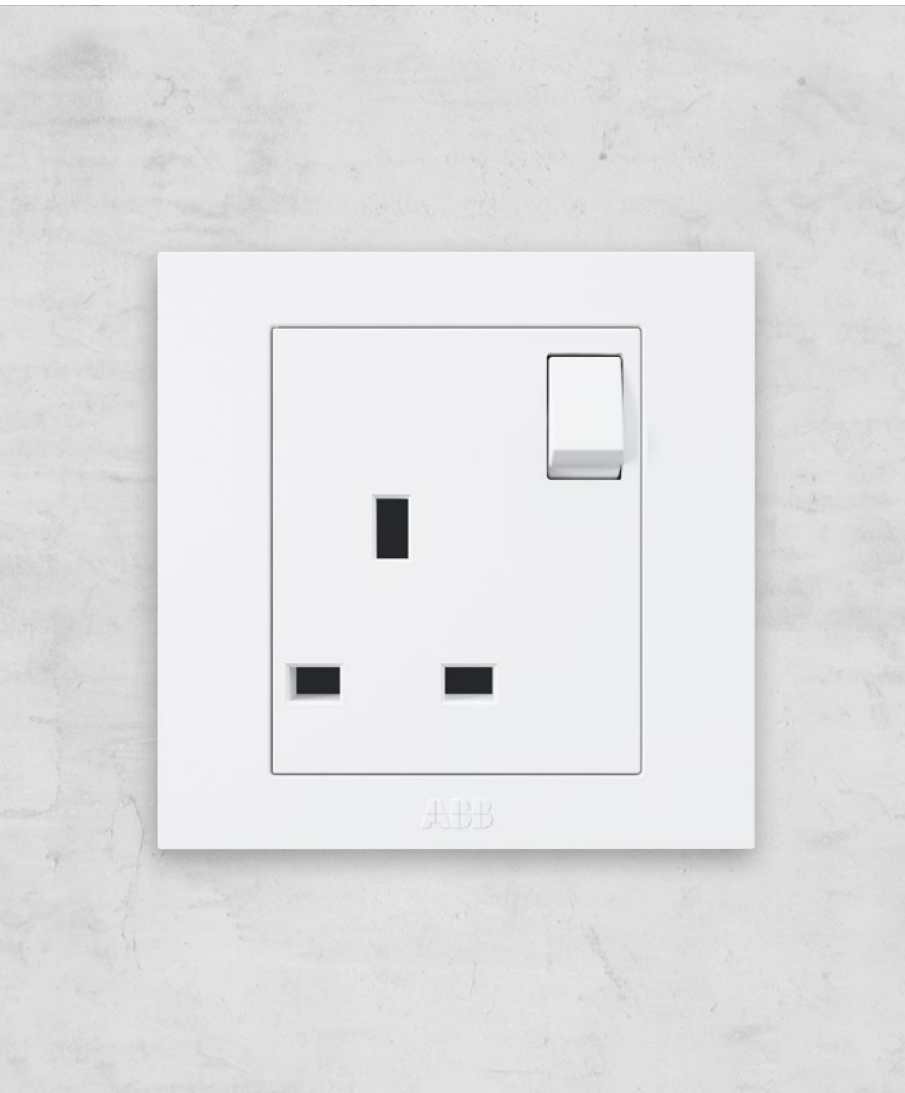

When you need to plug in and switch on your appliances, Kalo is your first choice. Besides basic wiring accessories, you will also get the dimmer, communication sockets and switched socket outlets – whether it's in a kitchen, a living room or a child's room. With a total above-wall switch height of just 7 mm, Kalo is always elegant.

**Features and Benefits**

- Thin cover and frame – just 7 mm
- Backlight with blue LED lighting
- Smooth switching
- High quality materials for contacts
- Included fasteners for furniture or boards
- Designed for mounting on uneven surfaces

Product overview

Switches

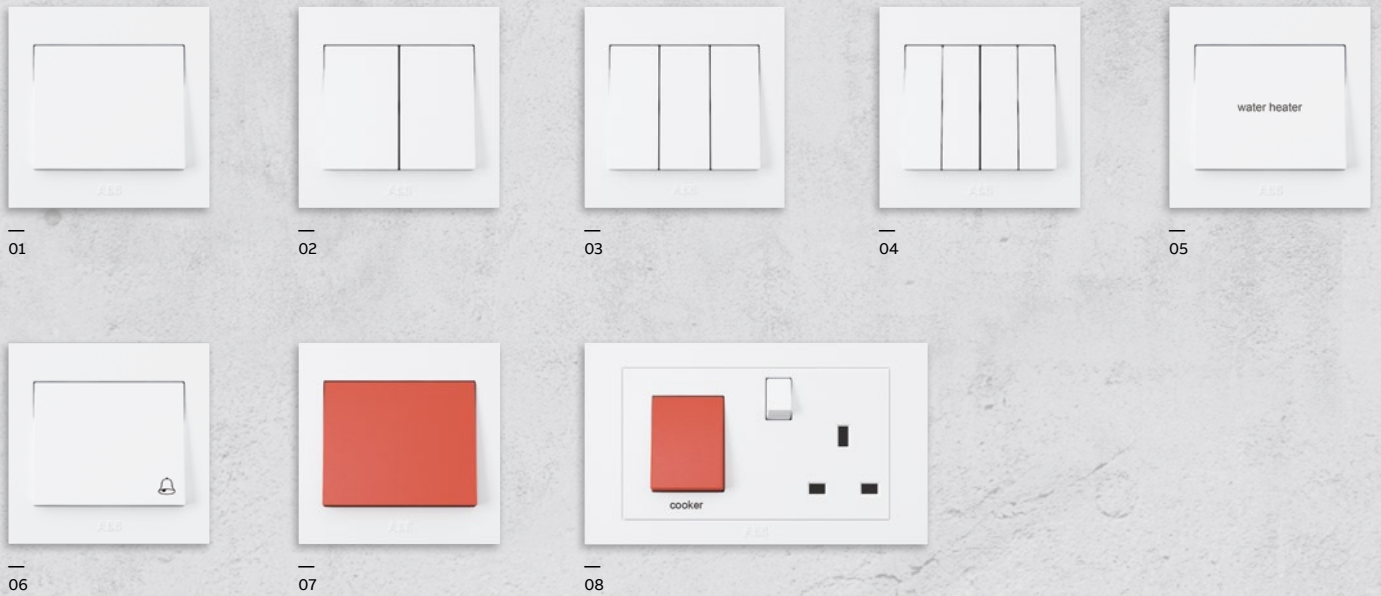

See product picture	Order Code	Type	Description	Technical Data	Flush-mounted Box Dimension
Switches					
01	2TCZ091001R0030	BH101	1 Gang 1 Way 10 AX SWITCH	10 AX	35 mm
02	2TCZ091003R0030	BH102	2 Gang 1 Way 10 AX SWITCH	10 AX	35 mm
03	2TCZ091005R0030	BH103	3 Gang 1 Way 10 AX SWITCH	10 AX	35 mm
04	2TCZ091007R0030	BH104	4 Gang 1 Way 10 AX SWITCH	10 AX	35 mm
01	2TCZ091002R0030	BH105	1 Gang 2 Way 10 AX SWITCH	10 AX	35 mm
02	2TCZ091004R0030	BH106	2 Gang 2 Way 10 AX SWITCH	10 AX	35 mm
03	2TCZ091006R0030	BH107	3 Gang 2 Way 10 AX SWITCH	10 AX	35 mm
04	2TCZ091008R0030	BH108	4 Gang 2 Way 10 AX SWITCH	10 AX	35 mm
01	2TCZ091095R0070	BH110	1 Gang 1 Way 20 AX SWITCH	20 AX	35 mm
01	2TCZ091096R0070	BH111	1 Gang 1 Way 20 AX DP SWITCH ILLUMINATED	20 AX	35 mm
01	2TCZ091097R0070	BH112	1 Gang 2 Way 20 AX SWITCH	20 AX	35 mm
02	2TCZ091018R0070	BH113	2 Gang 1 Way 20 AX DP SWITCH w/mark "On"	20 AX	35 mm
02	2TCZ091016R0070	BH114	2 Gang 1 Way 20 AX SWITCH	20 AX	35 mm
02	2TCZ091017R0070	BH115	2 Gang 2 Way 20 AX SWITCH	20 AX	35 mm
08	2TCZ091015R0090	BH118	COOKER CONTROL UNIT	45 A/13 A	47 mm
01	2TCZ091009R0030	BH119	1 Gang 10 AX INTERMEDIATE SWITCH	10 AX	35 mm
05	2TCZ091012R0075	BH171WH	1 Gang 1 Way 20 AX DP SW w/LED- MARKED WATER HEATER	20 AX	35 mm
01	2TCZ091013R0090	BH176	1 Gang 1 Way 32 A DP SWITCH	32 A	47 mm
07	2TCZ091014R0090	BH177	1 Gang 1 Way 45 A DP SWITCH	45 A	47 mm
07	2TCZ091098R0090	BH179	1 Gang 1 Way 45 A DP SWITCH ILLUMINATED	45 A	47 mm
06	2TCZ091011R0030	BH429	1 Gang 1 Way 10 A PUSH SWITCH- MARKED BELL	10 A	35 mm
01	2TCZ091010R0030	BH430	1 Gang 1 Way 10 A PUSH SWITCH	10 A	35 mm

Product overview

Socket outlets

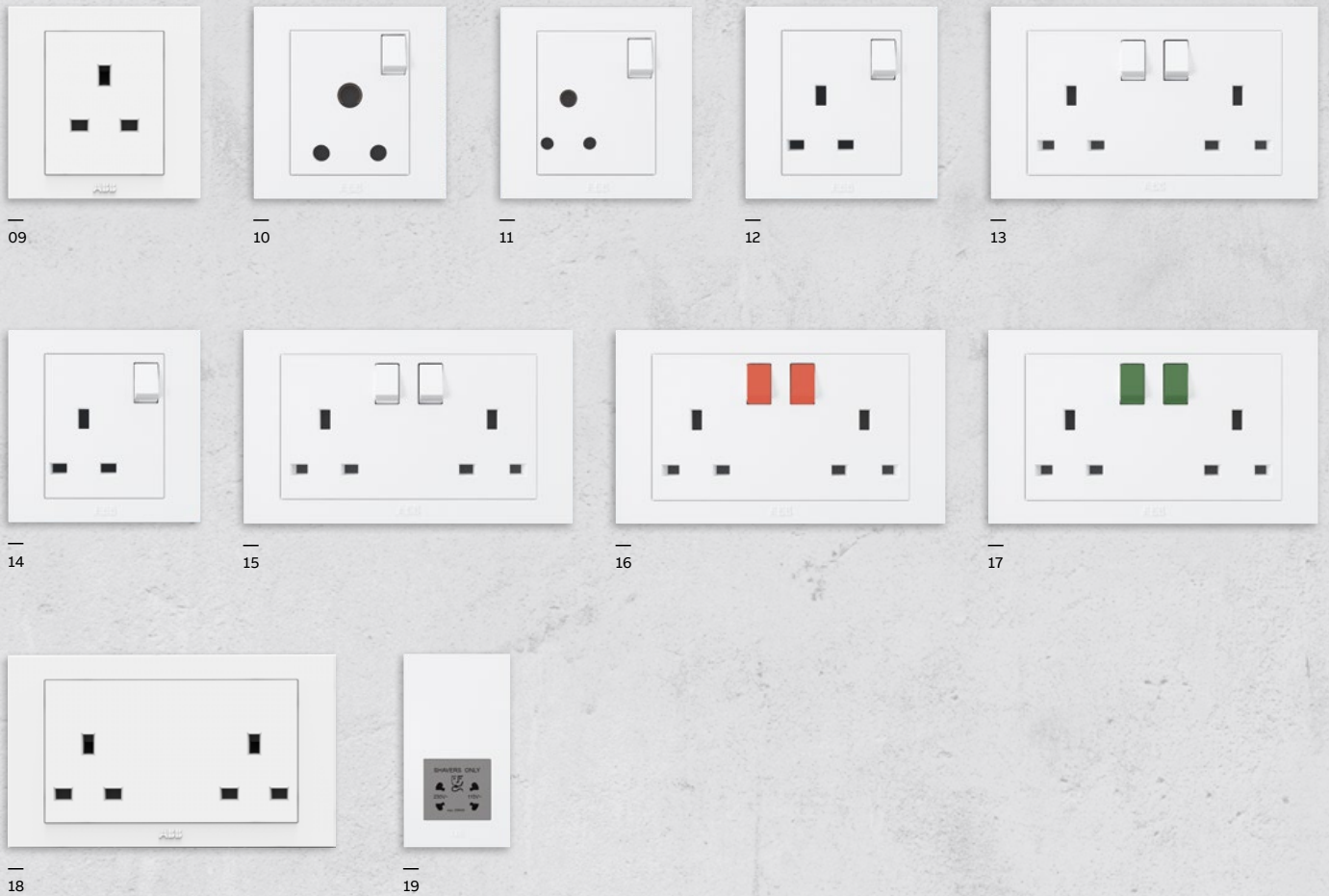

See product picture	Order Code	Type	Description	Technical Data	Flush-mounted Box Dimension
Socket					
09	2TCZ092014R0040	BH208	1 Gang 13 A UNSWITCHED SOCKET SP	13 A	35 mm
10	2TCZ092012R0050	BH209	1 Gang 15 A SWITCH SOCKET SP	15 A	35 mm
11	2TCZ092090R0020	BH220	1 Gang 5 A SWITCH SOCKET SP	5 A	35 mm
11	2TCZ092090R0020	BH221	1 Gang 5 A SWITCH SOCKET DP	5 A	35 mm
12	2TCZ092001R0040	BH224	1 Gang 13 A SWITCH SOCKET SP	13 A	35 mm
13	2TCZ092010R0040	BH227	2 Gang 13 A SWITCH SOCKET SP	13 A	35 mm
14	2TCZ092002R0040	BH229	1 Gang 13 A SWITCH SOCKET SP ILLUMINATED	13 A	35 mm
15	2TCZ092011R0040	BH230	2 Gang 13 A SWITCH SOCKET SP ILLUMINATED	13 A	35 mm
10	2TCZ092092R0050	BH231	1 Gang 15 A SWITCH SOCKET SP ILLUMINATED	15 A	35 mm
10	2TCZ092093R0050	BH232	1 Gang 15 A SWITCH SOCKET DP ILLUMINATED	15 A	35 mm
16	2TCZ092094R0040	BH236	2 Gang 13 A SWED SO SP WITH RED ROCKER- ILLUMINATED	13 A	35 mm
12	2TCZ092095R0040	BH237	1 Gang 13 A SWITCH SOCKET DP	13 A	35 mm
14	2TCZ092096R0040	BH238	1 Gang 13 A SWITCH SOCKET DP ILLUMINATED	13 A	35 mm
13	2TCZ092097R0040	BH239	2 Gang 13 A SWITCH SOCKET DP	13 A	35 mm
15	2TCZ092098R0040	BH240	2 Gang 13 A SWITCH SOCKET DP ILLUMINATED	13 A	35 mm
17	2TCZ092099R0040	BH241	2 Gang 13 A SWITCH SOCKET SP WITH GREEN ROCKER- w/LED	13 A	35 mm
18	2TCZ092015R0040	BH260	2 Gang 13 A UNSWITCHED SOCKET SP	13 A	35 mm
19	2TCZ094002R0010	BH401	Shaver Socket	Input: 230V, 50 Hz/60 Hz Outlet: 115 V/230 V, 20 VA	47 mm

Product overview

Data outlets/FCU & Flex outlets/Accessories



Product overview

Data outlets/FCU & Flex outlets/Accessories

See product picture	Order Code	Type	Description	Technical Data	Flush-mounted Box Dimension
Data outlets					
20	2TCZ093001R0010	BH301	1 Gang TV OUTLET- END OF LINE	end of line	35 mm
20	2TCZ093003R0010	BH304	1 Gang TV OUTLET- LOOP THROUGH	loop-through	35 mm
21	2TCZ093004R0010	BH307	1 Gang SAT OUTLET	F-type	35 mm
22	2TCZ093099R0010	BH308	1 Gang SAT OUTLET- 45 DEGREE	F-type	35 mm
23	2TCZ093006R0010	BH321	1 Gang TELEPHONE OUTLET	RJ11	35 mm
24	2TCZ093012R0010	BH322	2 Gang TELEPHONE OUTLET	RJ11 Cat.3	35 mm
25	2TCZ093010R0010	BH324	2 Gang TV/ TELEPHONE OUTLET	5-1000MHz RJ11	35 mm
26	2TCZ093016R0010	BH325	2 Gang TV/ DATA OUTLET	5-1000MHz RJ45 Cat.5e	35 mm
28	2TCZ093014R0010	BH329	2 Gang DATA OUTLET- CAT.6	RJ45 Cat.6	35 mm
27	2TCZ093007R0010	BH331	1 Gang DATA OUTLET- CAT.5e	RJ45 Cat.5e	35 mm
28	2TCZ093013R0010	BH332	2 Gang DATA OUTLET - CAT.5e	RJ45 Cat.5e	35 mm
27	2TCZ093008R0010	BH333	1 Gang DATA OUTLET- CAT.6	RJ45 Cat.6	35 mm
FCU & Flex outlets					
29	2TCZ091099R0070	BH120	20 A FLEX OUTLET	20 A	35 mm
30	2TCZ095006R0090	BH590	45 A FLEX OUTLET	45 A	35 mm
31	2TCZ095003R0040	BH506	FUSED CONNECTION UNIT UNSWED w/ FLEX OUTLET	13 A	35 mm
32	2TCZ095004R0040	BH507	FUSED CONNECTION UNIT SWED w/ FLEX OUTLET- w/LED	13 A	35 mm
32	2TCZ095099R0040	BH508	FUSED CONNECTION UNIT SWED w/ FLEX OUTLET	13 A	35 mm
Accessories					
33	2TCZ094001R0010	BH412	1 Gang ROTARY DIMMER	600 W	35 mm
34	2TCZ094009R0010	BH422	Fan Regulator	500 VA	35 mm
35	2TCZ095001R0010	BH504	1 Gang BLANK PLATE	-	35 mm
36	2TCZ095002R0010	BH505	2 Gang BLANK PLATE	-	35 mm

Product Standard

Product description	Standart	Description
Switches	BSEN60669-1 / IEC60669-1 / MSIEC60669-1 / GB16915	Switches for household and similar fixed electrical installation
Dimmers	IEC60669-2-1	Dimmers
Fan Regulator	IEC60669-2-1	Fan Regulator
TV outlet	BS3041-2 / IEC60169-2 / BSEN 50083 / BS5733	Radio frequency connectors. Specification for coaxial unmatched connector
Computer outlet RJ45	BSEN 50173 / ISO/IEC 11801 / TIA/EIA TSB40A / TIA/EIA 568A / IEC 60607-3	Commercial building telecommunications cabling standard Part 2: Balanced twisted pair cabling components
Telephone outlet RJ11	FCC68 / BS5733	Commercial building telecommunications cabling standard Part 2: Balanced twisted pair cabling components
Fused Connection units	BS1363 Part4 / SS403	Specification for 13 A fused connection units switched and unswitched
Flex outlet 20 A / 45 A	BS5733 / MS1144	General requirements for electrical accessories
13 A sockets	BS1363 part 2 / SSA 443-444-2203 / MS 589-2 / SS 145-2 / IEC60884-1	13 A switched and unswitched socket outlets
13 A universal socket	BS5733 / MS1144 / GB2099.1 / IEC60884-1	General requirements for electrical accessories
15 A sockets	BS546 / SS472 / IEC60884-1	Two-pole and earthing-pin plugs, socket outlets and socket-outlet adaptors
Shaver socket	IEC60558-2-5	Shaver control unit
Cooker control unit	BS4177 / IEC60884-1	Cooker control unit
Plates	BS5733/MS1144	Specification for general requirements for electrical accessories
5A Sockets	BS546 / IEC60884-1	Two-pole and earthing-pin plugs, socket outlets and socket-outlet adaptors

Product Technical Information

Dimensions

Dimensions for 1 gang frames

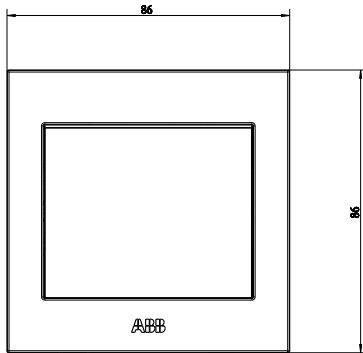

Distance between fixing screws for 1 gang frames

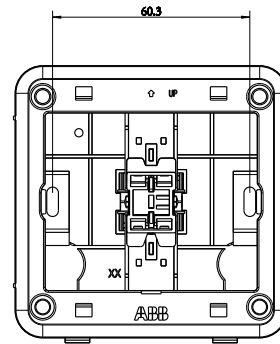

Dimensions for 2 gang frames

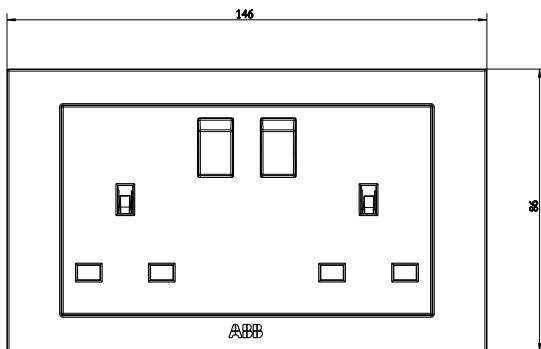

Distance between fixing screws for 2 gang frames

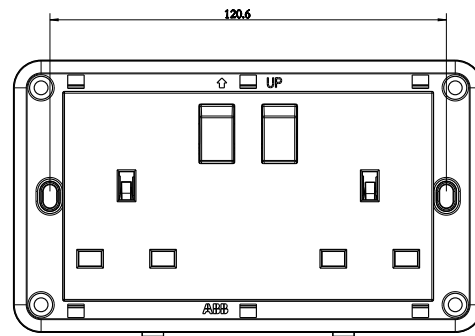

Dimensions for Shaver socket

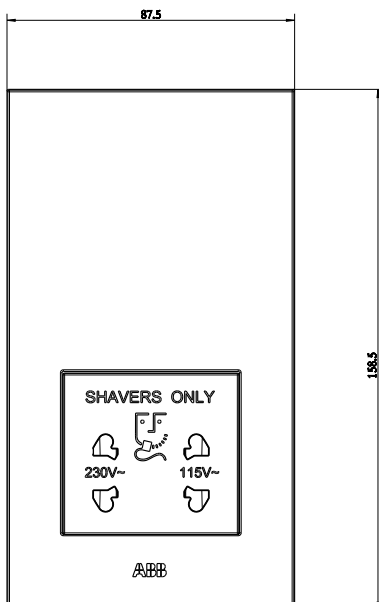

Distance between fixing screws for Shaver socket

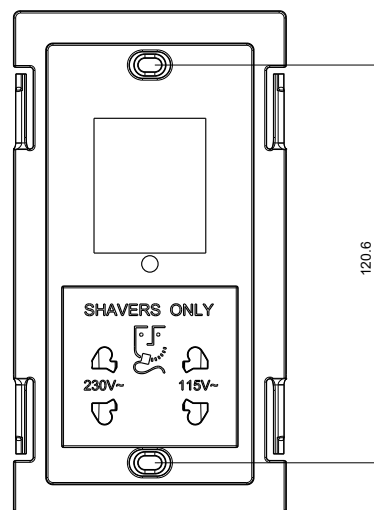

Product Technical Information

Wiring Diagram

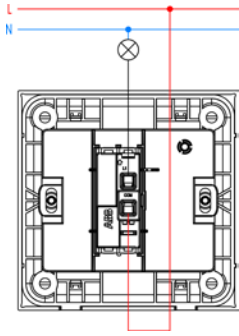

1G 1W switch

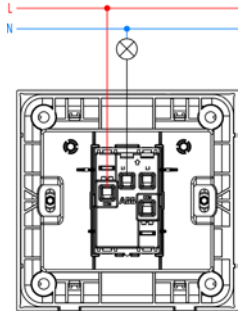

2G 1W switch

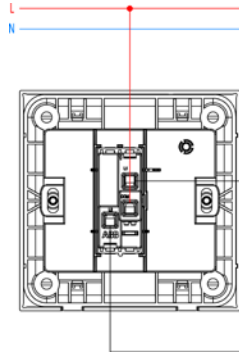

1G 2W switch

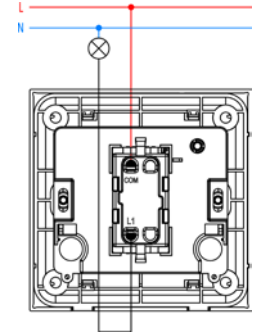

1G 1W 20 AX switch

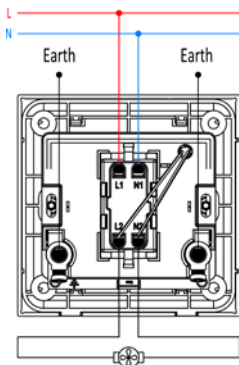

1G 1W DP switch

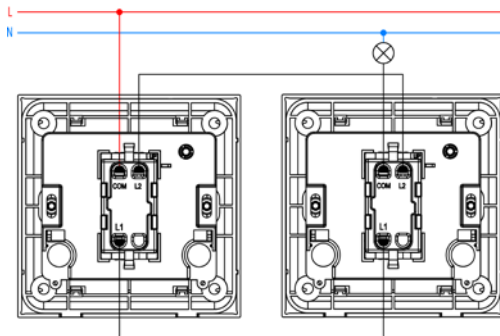

2G 2W 20 AX switch

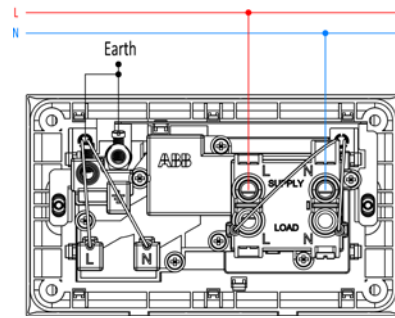

cooker control unit

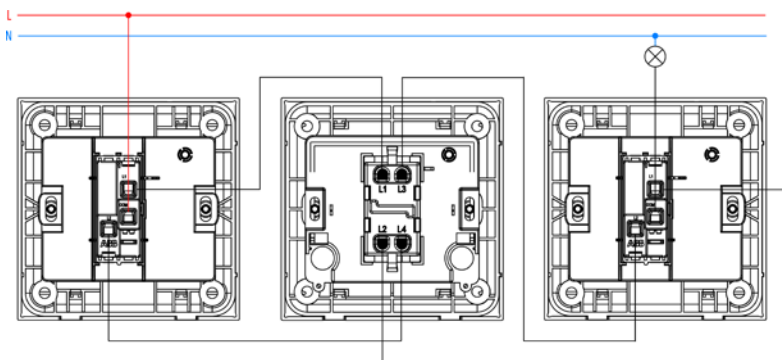

1G intermediate switch

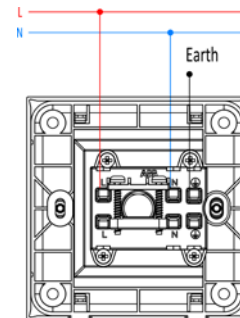

flex outlet 20 A

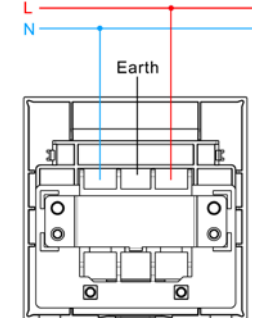

flex outlet 45 A

Product Technical Information

Wiring Diagram

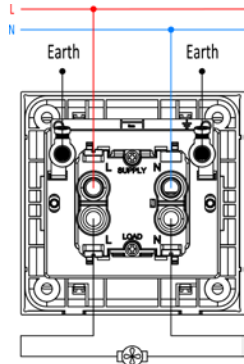

1G 1W 32 A (45 A) DP switch

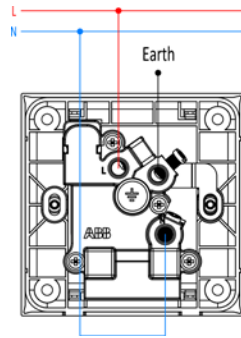

1G switch socket outlet

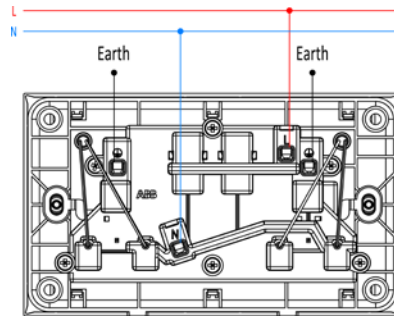

2G 13 A switch socket outlet SP

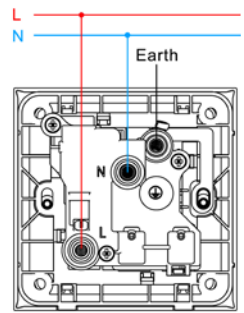

1G 5 A switch socket DP

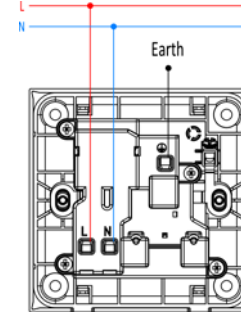

1G 13 A switch socket DP

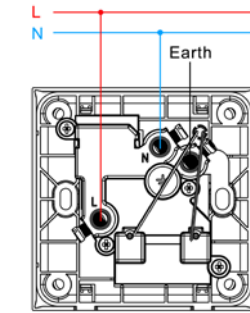

1G 15 A switch socket DP

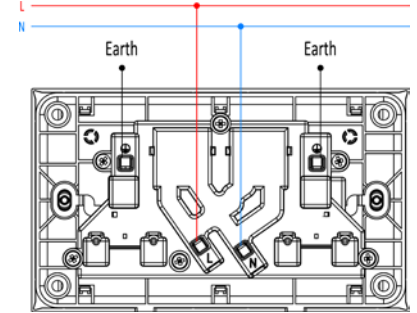

2G 13 A switch socket DP

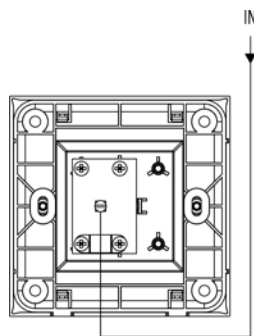

1G TV outlet

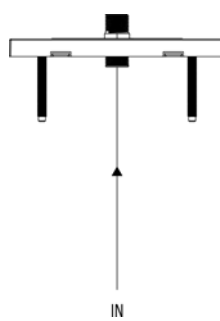

1G SAT outlet

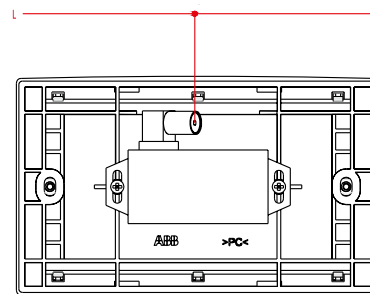

TV/FM splitter

Product Technical Information

Wiring Diagram

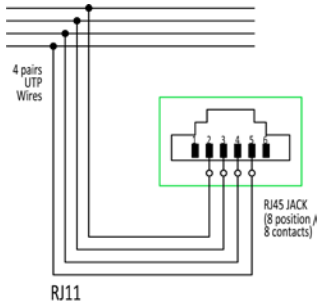

Wiring Color Code		
Pin Number	Base Color	Indication
1	-	-
2	Black	Earth
3	Red	L2
4	Green	L1
5	Yellow	Spare
6	-	-

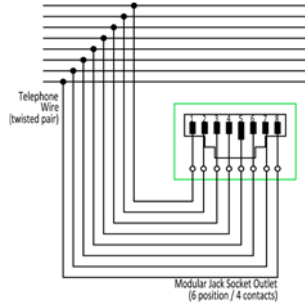

Pin Number	Wiring Color Code	
	EIA-T568A Wire Colour	EIA-T568B Wire Colour
1	White/Green	White/Orange
2	Green	Orange
3	White/Orange	White/Green
4	Blue	Blue
5	White/Blue	White/Blue
6	Orange	Green
7	White/Brown	White/Brown
8	Brown	Brown

1G telephone outlet

1G / 2G data outlet

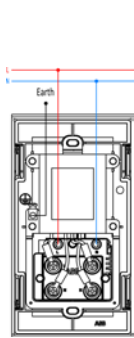

shaver socket

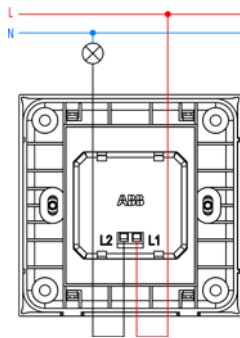

1G rotary dimmer

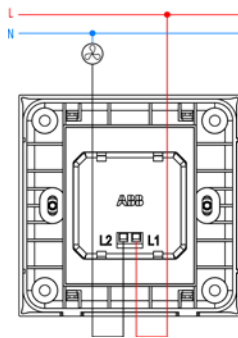

fan regulator

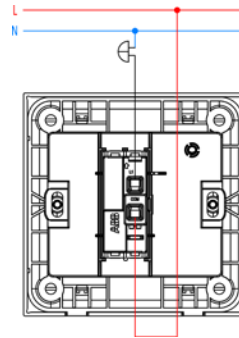

1G 1W push switch

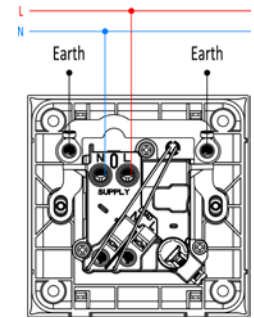

fused connection unit

-
- Te UAE**
ABB Industries LLC
 Al Quoz Industrial Area 3
 4th Interchange, St. No: 4 Dubai
 Phone: 0097 143147500
-
- Saudi Arabia**
ABB Electrical Industries Co. Ltd.
 Al Ahsa Street, Malaz 11371, Riyadh
 Phone: 00966 11 4845600
-
- Qatar**
ABB LLC
 Al Asmakh Tower, 15th floor
 864 Hazm Zraig St., Bldg No. 49
 Zone 63, Onaiza District, West Bay
 PO BOX 8688, Qatar
 Phone: +974 4425 3888
-
- Kuwait**
ABB Engineering Technologies Co. (KSCC)
 Alghunaim Commercial Tower, 2nd Floor, Al-Qibla Area
 P.O.Box 4275, Safat-13043, Abu Baker Al-Sadique Street,
 Kuwait
 Phone: +965 2428626
-
- Bahrain**
ABB Technologies W.L.L.
 Gulf Executive Offices, 12/F, Office 1023
 Entrance 15, Road 3801, AlGudaibiya 338
 P.O.Box 2774, Manama, Kingdom of Bahrain
 Phone : +973 17810659
-
- Oman**
ABB LLC
 218, Hatat House, P. O. Box 778,
 131 Al Hamriya Muscat, Oman
 Phone: 00968 24 567 410
-
- Nigeria**
ABBNG LTD
 Plot 8C Metalbox road, off Acme
 road Ogba, Ikeja, Lagos, Nigeria
 Phone: 0023412705669
-
- Asea Brown Boveri Lanka (Pvt) Limited**
 Level 18, West Tower, World Trade Center
 Colombo 00100, Sri Lanka
 Phone : +94 (0) 112 399304/6
-
- Ghana**
ABB
 2nd Floor, Heritage Tower
 6th Avenue Ridge, Accra
 Phone: 00233 (0) 302631500
-
- Singapore**
ABB Pte. Ltd.
 2, Ayer Rajah Crescent
 SGP - 139935 Singapore
 Phone: +65 6 776 5711
-
- Malaysia**
ABB Malaysia Sdn Bhd
 Block A, Level 2, Lot 608, Jalan SS13/1K
 47500 Subang Jaya
 MY Selangor Darul Ehsan
 Phone: +603 5628 4888
-
- Vietnam**
ABB Ltd. (Vietnam)
 Km 9 National Highway 1A, Hoang Liet, Hoang Mai,
 Hanoi, Vietnam
 Phone: +8448611010
-
- Hong Kong China**
ABB (Hong Kong) Limited
 Units 3-4, 7/F, Skyway House, South Block,
 3 Sham Mong Road, Tai Kok Tsui, Kowloon, Hong Kong
 Phone: +852 2929-3912
-
- Pakistan**
ABB (Pakistan) Ltd.
 4-B, Chamba House Lane
 GOR-1 Lahore, Pakistan
 Phone: +92 42 631 5882-6



—
[new.abb.com/low-voltage/products/
residential-products](https://new.abb.com/low-voltage/products/residential-products)