

---

CATALOGUE

# General purpose enclosures

## Heavy duty and industrial enclosures



- Boxes for distribution systems and OEM applications
- Automation- and distribution boards
- Enclosures for data and telecommunications
- Pedestals and column cabinets

---

**General purpose enclosures of ABB are revolutionizing the market of low voltage electric insulating switchboards and industrial boxes. No matter how harsh the environment is, there is always a proper enclosure for your needs. Thanks to protection ratings and high quality materials this fits for a wide variety of indoor and outdoor applications.**

---

# Table of contents

<b>01. Multibox</b>	4
<b>02. APO</b>	18
<b>03. VMS</b>	38
<b>04. ARIA</b>	64
<b>05. PolySafe</b>	76
<b>06. Accessories</b>	98
<b>07. Pedestals</b>	128
<b>08. Gemini: the improved range</b>	168
<b>09. SR2</b>	230
<b>10. SRX</b>	256

—  
**01**

# **Multibox**

---













































# Multibox

## Index

<b>MultiBox</b>	
Small multi-purpose boxes for all types of application	7
Accessories	12
Dimensional	13
Power dissipation values	17

## General purpose enclosures

### Range overview

IP66 Multibox	IP67 APO	IP65/66 ARIA	IP54/55/65 PolySafe
 65x65x57/81	 186x151x140	 300x200x170	 500x500x320
 94x65x57/81	 302x186x175	 400x300x170	 500x750x320
 94x94x57/81	 302x302x175	 500x400x230	 500x1000x320
 110x110x66/90	 372x302x175	 600x400x230	 750x500x320
 130x94x57/81	 488x302x175	 700x500x270	 750x750x320
 130x130x75/99	 558x302x175	 800x600x300	 750x1000x320
 180x94x57/81	 603x302x175	 1000x800x300	 750x1250x320
 180x110x90/111/165	 603x372x175		 1000x500x320
 182x180x90/111/165	 603x372x175		 1000x750x320
 254x180x90/111/165	 603x603x175		 1000x1000x320
 361x254x111/165			 1000x1000x320
			 1000x1250x320
			 1250x750x320
			 1250x1000x320
			 1250x1000x320
			 1250x1000x320

## General purpose enclosures

MultiBox - Small multi-purpose boxes for all types of application



MultiBox

### Applications

- Ideal for industrial automation and control, machinery and OEM.
- Electronic applications in the telecommunications industry.
- May also be used in tertiary and energy distribution applications.

**Standard: EN/IEC 60670-22 (Polystyrene), EN/IEC 61439-3 (Polycarbonate)**

### Specifications and advantages

- 11 different sizes of box are available (from 65 x 65 mm up to 361 x 254 mm) plus 3 different cover heights.
- Material: polystyrene or polycarbonate reinforced with glass fiber.
- Color: RAL 7035 gray
- High protection rating, IP66-IK07 for polystyrene and IP66-IK08 for polycarbonate, thanks to the injected polyurethane gasket.
- Polycarbonate boxes are available with a smooth surface (one single entry) or with multiple metric cutouts.
- Polystyrene boxes are available with a smooth surface or with multiple metric cutouts.
- Opaque gray or transparent covers available in various heights.
- Designed for installation on all types of surface.
- Vertical and horizontal coupling.
- Polystyrene boxes (glow wire tested to 650°C) can withstand temperatures of up to +70°C, polycarbonate boxes (glow wire tested to 950°C) can withstand temperatures of up to +120°C.
- Total insulation  $\square$ .
- High level of resistance to chemical and aggressive environments.
- Halogen-free.
- Self-extinguishing (UL94-V2).
- Insulation voltage  $U_i = 1000 \text{ V}$

### Why choose MultiBox?

Would you prefer a standard product or a custom one?

Or, would you prefer a “turnkey” solution (assembled/wired)?

ABB can offer you custom products and comprehensive solutions to meet your requirements!

## General purpose enclosures

MultiBox - Small boxes for all types of application

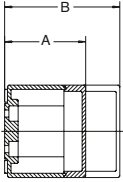

		Polystyrene		Polycarbonate <sup>(1)</sup>			
		Gray cover RAL 7035		Gray cover RAL 7035		Cover transparent	
Back box	Depth	Type	Order code	Type	Order code	Type	Order code
<b>MB 11 HxL = 65x65mm</b>							
With one metric cutout	A = 57	MB861612	4TBG861612C0100	MB861500	4TBG861500C0100	MB861501	4TBG861501C0100
	B = 81	MB861614	4TBG861614C0100	MB861502	4TBG861502C0100	MB861503	4TBG861503C0100
Smooth	A = 57	MB861668	4TBG861668R0100				
	B = 81	MB861670	4TBG861670C0100				
<b>MB 21 HxL = 94x65mm</b>							
With one metric cutout	A = 57	MB861616	4TBG861616C0100	MB861504	4TBG861504C0100	MB861505	4TBG861505C0100
	B = 81	MB861618	4TBG861618C0100	MB861506	4TBG861506C0100	MB861507	4TBG861507C0100
Smooth	A = 57	MB861672	4TBG861672C0100				
	B = 81	MB861674	4TBG861674C0100				
<b>MB 22 HxL = 94x94mm</b>							
With one metric cutout	A = 57	MB861620	4TBG861620R0100	MB861508	4TBG861508C0100	MB861509	4TBG861509C0100
	B = 81	MB861622	4TBG861622C0100	MB861510	4TBG861510C0100	MB861511	4TBG861511C0100
Smooth	A = 57	MB861676	4TBG861676R0100				
	B = 81	MB861678	4TBG861678C0100				
<b>MB 33 HxL = 110x110mm</b>							
With one metric cutout	A = 66	MB861624	4TBG861624R0100	MB861512	4TBG861512C0100	MB861513	4TBG861513C0100
	B = 90	MB861626	4TBG861626R0100	MB861514	4TBG861514C0100	MB861515	4TBG861515C0100
Smooth	A = 66	MB861680	4TBG861680C0100				
	B = 90	MB861682	4TBG861682C0100				
<b>MB 42 HxL = 130x94mm</b>							
With one metric cutout	A = 57	MB861628	4TBG861628R0100	MB861516	4TBG861516C0100	MB861517	4TBG861517C0100
	B = 81	MB861630	4TBG861630R0100	MB861518	4TBG861518R0100	MB861519	4TBG861519C0100
Smooth	A = 57	MB861684	4TBG861684R0100				
	B = 81	MB861686	4TBG861686C0100				
<b>MB 44 HxL = 130x130mm</b>							
With one metric cutout	A = 75	MB861632	4TBG861632R0100	MB861520	4TBG861520R0100	MB861521	4TBG861521C0100
	B = 99	MB861634	4TBG861634R0100	MB861522	4TBG861522R0100	MB861523	4TBG861523C0100
Smooth	A = 75	MB861688	4TBG861688C0100				
	B = 99	MB861690	4TBG861690R0100				
<b>MB 52 HxL = 180x94mm</b>							
With one metric cutout	A = 57	MB861636	4TBG861636R0100	MB861524	4TBG861524C0100	MB861525	4TBG861525C0100
	B = 81	MB861638	4TBG861638R0100	MB861526	4TBG861526C0100	MB861527	4TBG861527C0100
Smooth	A = 57	MB861692	4TBG861692C0100				
	B = 81	MB861694	4TBG861694C0100				

(1) Smooth = one metric cutout on the short side for a supply cable.

Pack = 1



## General purpose enclosures

MultiBox - Small boxes for all types of application



(for terminals)



(for terminals and equipment)

Mounting plate (insulated)		DIN profile 15 x 5 x 1		DIN profile 35 x 7.5 x 1	
Type	Order code	Type	Order code	Type	Order code
				-	
<b>74x45 mm</b>					
MB861731	4TBG861731C0100			-	
				-	
<b>74x74 mm</b>		<b>L=49.5 short side</b>			
MB861732	4TBG861732C0100	MB861741	4TBG861741C0100	-	
<b>90x90 mm</b>		<b>L=80 long/short side</b>			
MB861733	4TBG861733R0100	MB861742	4TBG861742R0100		
<b>110x74 mm</b>		<b>L=92 long/short side</b>		<b>L=81 long/short side</b>	
MB861734	4TBG861734R0100	MB861743	4TBG861743C0100	MB861746	4TBG861746R0100
<b>110x110 mm</b>		<b>L=111 long/short side</b>		<b>L=106 long/short side</b>	
MB861735	4TBG861735R0100	MB861744	4TBG861744R0100	MB861747	4TBG861747R0100
<b>160x74 mm</b>		<b>L=154 long side</b>		<b>L=144 long side</b>	
MB861736	4TBG861736R0100	MB861745	4TBG861745C0100	MB861748	4TBG861748R0100

## General purpose enclosures

MultiBox - Small boxes for all types of application

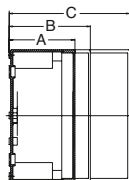

		Polystyrene		Polycarbonate <sup>(1)</sup>			
		Gray cover RAL 7035		Gray cover RAL 7035		Transparent cover	
Back box	Depth	Type	Order code	Type	Order code	Type	Order code
<b>MB 53 H x L = 180 x 110 mm</b>							
With a metric cutout	A = 90	MB861640	4TBG861640R0100	MB861528	4TBG861528C0100	MB861529	4TBG861529C0100
	B = 111	MB861642	4TBG861642R0100	MB861530	4TBG861530R0100	MB861531	4TBG861531R0100
	C = 165	MB861644	4TBG861644R0100	MB861532	4TBG861532C0100	MB861533	4TBG861533C0100
Smooth	A = 90	MB861696	4TBG861696R0100				
	B = 111	MB861698	4TBG861698C0100				
	C = 165	MB861700	4TBG861700C0100				
<b>MB 65 H x L = 182 x 180 mm</b>							
With a metric cutout	A = 90	MB861646	4TBG861646R0100	MB861534	4TBG861534C0100	MB861535	4TBG861535C0100
	B = 111	MB861648	4TBG861648R0100	MB861536	4TBG861536R0100	MB861537	4TBG861537R0100
	C = 165	MB861650	4TBG861650R0100	MB861538	4TBG861538C0100	MB861539	4TBG861539C0100
Smooth	A = 90	MB861702	4TBG861702R0100				
	B = 111	MB861704	4TBG861704C0100				
	C = 165	MB861706	4TBG861706C0100				
<b>MB 75 H x L = 254 x 180 mm</b>							
With a metric cutout	A = 90	MB861654	4TBG861654R0100	MB861542	4TBG861542C0100	MB861543	4TBG861543C0100
	B = 111	MB861656	4TBG861656R0100	MB861544	4TBG861544R0100	MB861545	4TBG861545R0100
	C = 165	MB861658	4TBG861658C0100	MB861546	4TBG861546R0100	MB861547	4TBG861547R0100
Smooth	A = 90	MB861710	4TBG861710R0100				
	B = 111	MB861712	4TBG861712R0100				
	C = 165	MB861714	4TBG861714R0100				
<b>MB 87 H x L = 361 x 254 mm</b>							
With a metric cutout	B = 111	MB861662	4TBG861662R0100	MB861550	4TBG861550C0100	MB861551	4TBG861551R0100
	C = 165	MB861664	4TBG861664R0100	MB861552	4TBG861552C0100	MB861553	4TBG861553C0100
Smooth	B = 111	MB861718	4TBG861718C0100				
	C = 165	MB861720	4TBG861720R0100				

(1) Smooth = one metric cutout on the short side for a supply cable.

Pack = 1

### Table of dimensions

MB (MultiBox)	Height	Width
11	65	65
21	94	65
22	94	94
33	110	110
42	130	94
44	130	130
52	180	94
53	180	110
65	182	180
75	254	180
87	361	254

## General purpose enclosures

MultiBox - Small boxes for all types of application





(for terminals and equipment)

Mounting plate (insulated)		DIN profile 35 x 7.5 x 1	
Type	Order code	Type	Order code
<b>150x90mm</b>			
MB861737	4TBG861737R0100		
<b>150x150mm</b>		<b>L=144 long side</b>	
MB861738	4TBG861738R0100	MB861748	4TBG861748R0100
<b>220x150mm</b>		<b>L=216 long side</b>	
MB861739	4TBG861739R0100	MB861749	4TBG861749R0100
<b>331x220mm</b>		<b>L=336 long side</b>	
MB861740	4TBG861740R0100	MB861750	4TBG861750C0100

## General purpose enclosures

### MultiBox - Accessories

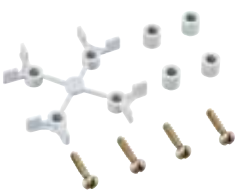
Product	Type	Order code	Pack
<b>Coupling kit</b>			
For assembling multiple boxes horizontally and/or vertically			
	① Small M20	MB861753 4TBG861753C0100	5
	① Small M25	MB861754 4TBG861754C0100	5
	① Small M32	MB861755 4TBG861755C0100	5
	② Large from MB 53	MB861756 4TBG861756C0100	1
	<b>Hinges</b>		
	Open all boxes using the hinged covers		
	Large from MB 53	MB861758 4TBG861758R0100	1
	<b>Fixing lugs</b>		
For external securing of the entire range			
	1 set of 4 lugs	MB861759 4TBG861759C0100	1
	<b>Spacers</b>		
Plastic material (6 + 8 mm), sets the distance between the boxes or the mounting plate and the base of the box			
	1 set of 8 parts. (includes securing screws)	MB861762 4TBG861762C0100	1

Product	Type	Order code	Pack	
<b>Carry handle</b>				
(plastic, green in color)				
	Includes plastic screws	MB861764 4TBG861764C0100	1	
	Includes self-tapping screws	MB861765 4TBG861765C0100	1	
<b>IP66 double membrane nipple</b>				
IP66 double membrane connection. For assembly without locking nuts. Membrane includes 2 integral seals				
	M16	MB861724 4TBG861724R0100	50	
	M20	MB861725 4TBG861725R0100	50	
	M25	MB861726 4TBG861726R0100	50	
	M32	MB861727 4TBG861727C0100	25	
	<b>Vent (IPx4)</b>			
	Provides ventilation and prevents condensation. Vents should preferably be installed in the upper and lower sections of the box.			
	MB861728 4TBG861728R0100	25		
	<b>Cover screws</b>			
(plastic, green in color)				
Short for the cover. Depth A				
MB861769 4TBG861769R0100 20				
Long for the cover. Depth B & C				
MB861770 4TBG861770C0100 20				

# General purpose enclosures technical details

## MultiBox – Dimensions

**MB11 - MB42**  
**Polystyrene/  
 Polycarbonate**

**Polycarbonate\***

MB11

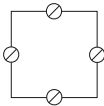

Metric knockouts  
 ∅ = M16/20

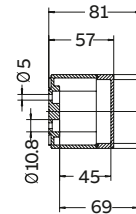
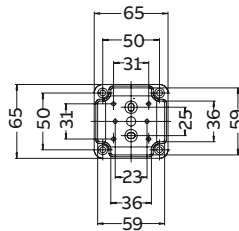

MB21

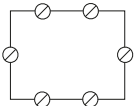

Metric knockouts  
 ∅ = M16/20

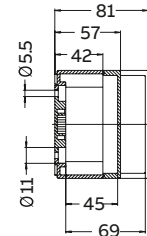
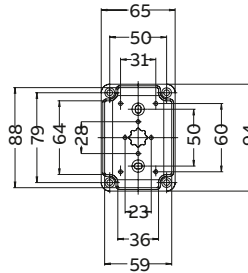

MB22

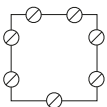

Metric knockouts  
 ∅ = M16/20

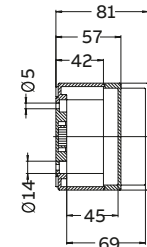
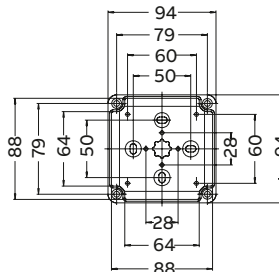

MB33

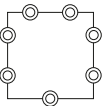

Metric knockouts  
 ∅ = M20/25

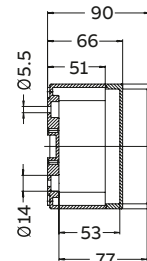
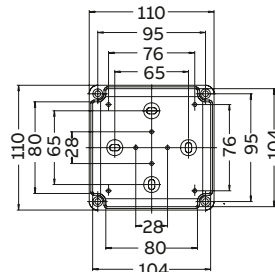

MB42

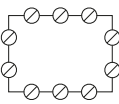

Metric knockouts  
 ∅ = M16/20

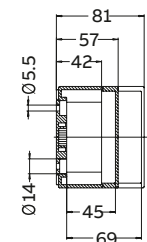
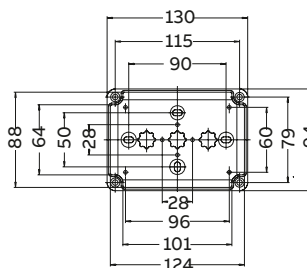

(\* ) Smooth = one metric knock-out on short side for power supply cord

# General purpose enclosures technical details

## MultiBox – Dimensions

**MB44-MB75**  
**Polystyrene/  
 Polycarbonate**

**Polycarbonate\***

MB44

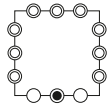

Metric knockouts  
 ○ = M20  
 ⊙ = M20/25  
 ● = M25/32

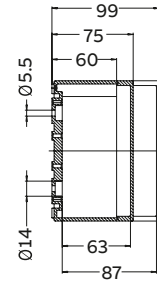
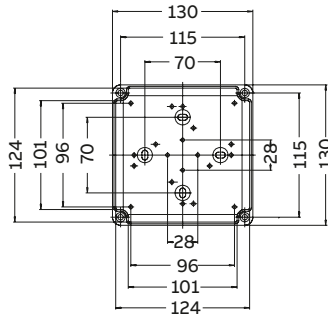

MB52

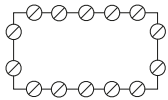

Metric knockouts  
 ⊙ = M16/20

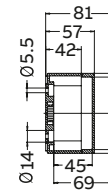
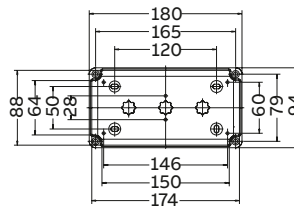

MB53

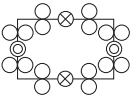

Metric knockouts  
 ○ = M20  
 ⊙ = M20/25  
 ● = M25/32  
 ⊗ = M32/40

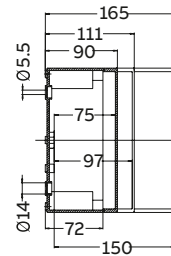
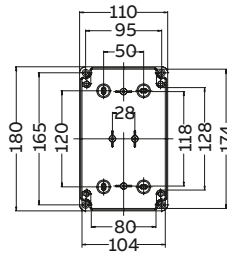

MB65

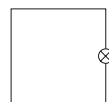
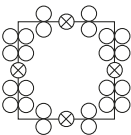

Metric knockouts  
 ○ = M20  
 ⊗ = M32/40

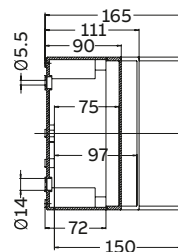
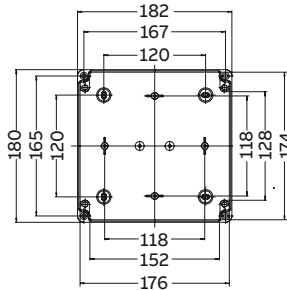

MB75

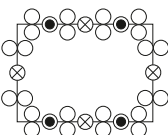

Metric knockouts  
 ○ = M20  
 ● = M25/32  
 ⊗ = M32/40

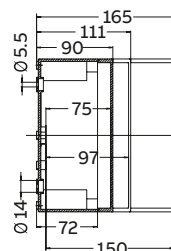
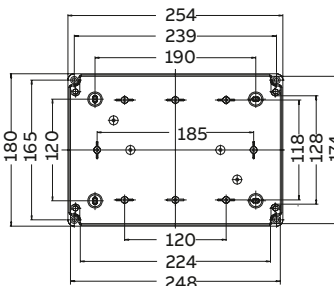

(\* ) Smooth = one metric knock-out on short side for power supply cord

# General purpose enclosures technical details

## MultiBox – Dimensions

**MB87**

**Polystyrene/  
Polycarbonate**

**Polycarbonate\***

MB87

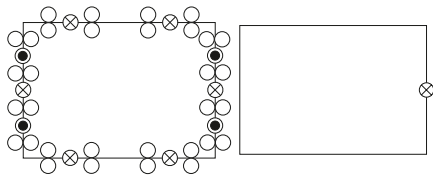

Metric knockouts  
 ○ = M20  
 ● = M25/32  
 ⊗ = M32/40

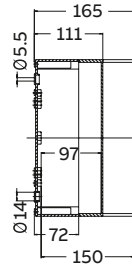
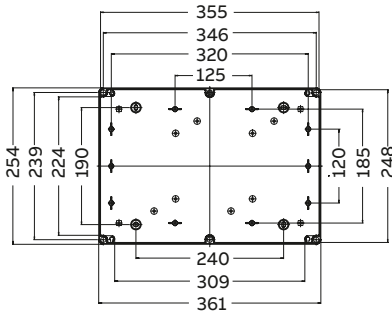

(\*) Smooth = one metric knock-out on short side for power supply cord







—  
02

**APO**

---

**APO**  
Index

<b>APO</b>	
Modular polyester boxes	20
Accessories	26
Functions for modular equipment	29
Stand-alone equipped boxes	30
APO 61 - □ IP44-IK10 distribution enclosures	31
Dimensional drawings - Bases	32
Dimensional drawings for mounting	33
Dimensional drawings - Cut-outs in side panels	34
Dimensional drawings - Cable-end boxes	35
Power dissipation values	36

## General purpose enclosures

### APO - Modular polyester boxes



APO

#### Applications

- Heavy industry
- Refineries
- Shipyards
- Steelworks
- Breweries
- Petro-chemical industry
- Public works
- Solar energy applications

**Standard: EN/IEC 61439-2, EN/IEC 60529, EN/IEC 62208**

#### Specifications

- The range comprises nine different sizes with 300 and 185 mm modules.
- The base is fabricated from polyester, hot press molded and reinforced with glass fiber, dyed in mass RAL 7035 light gray color. It is equipped with M4 inserts (Dodge-type) for attaching a mounting plate or a frame.
- The cover may be fabricated from transparent polycarbonate or hot press molded polyester, reinforced with glass fiber, dyed in mass RAL 7035 light gray color.
- Maximum protection for the user and equipment thanks to its total insulation  $\square$  and IP67 protection rating in accordance with EN/IEC 60529.
- IK10 protection rating against external mechanical impacts in accordance with EN/IEC 62208.
- Each box, which is a multiple of a smaller one, also has a variety of the mounting points of the smaller box. These points have non-threaded holes for embedded M4 inserts.
- The base also includes four to six non-threaded holes for embedded M6 inserts.
- The box may be wall-mounted or on a pedestal.
- Material is simple to work with using conventional tools such as drills, mills, saws, etc.
- Polyester boxes can resist temperatures of up to 70°C under continuous operation and peak temperatures of up to 130°C. The transparent polycarbonate covers can resist operating temperatures of up to 120°C.
- Insulation voltage  $U_i = 1000\text{ V}$  and  $1500\text{ V dc}$
- APO enclosures are UL Listed, in accordance with the UL Standard 508. They are also CSA-certified.

#### Standards/Certification



- Boxes with polyester cover: types 3, 3R, 4, 4X, 6, 6P, 12 and 13
- Enclosures with polycarbonate cover: types 3, 3R, 4, 4X, 12 and 13
- Boxes with hinged cover: types 3, 3R, 4, 4X, 6, 12 and 13  
Available upon request.



- Boxes with polyester cover: types 3, 3R, 4, 4X, 6, 6P, 12 and 13
- Boxes with polycarbonate cover: types 3, 3R, 4, 4X, 12 and 13
- Boxes with hinged cover: types 3, 3R, 4, 4X, 6, 12 and 13  
Available upon request.

Lloyd's Register of Shipping

## General purpose enclosures

### APO - Modular polyester boxes

#### Modular insulated box system

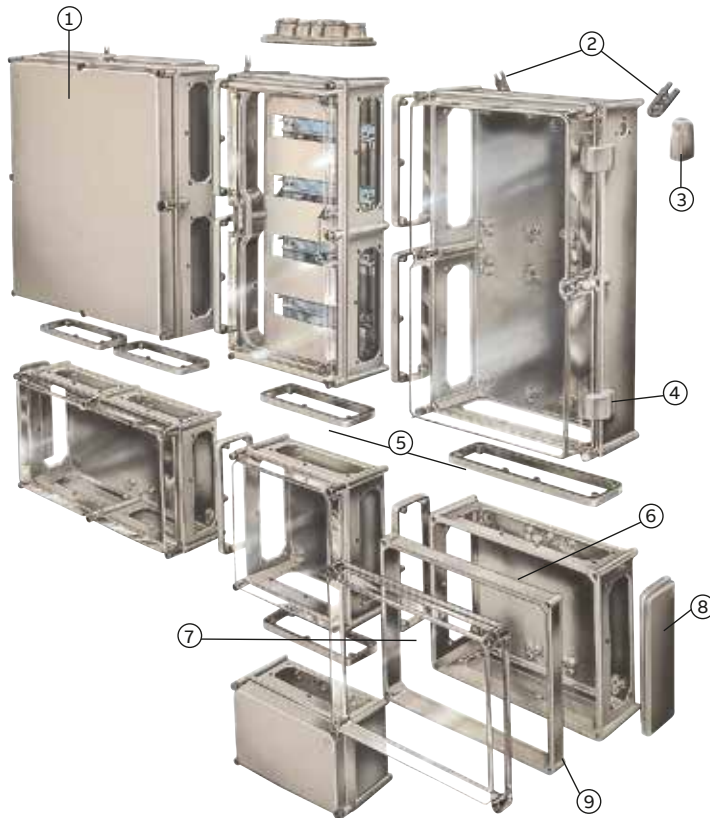

1. Polyester cover
2. Fixing lugs, stainless steel or polyamide
3. Fan
4. Hinge made from insulating material
5. Coupling frame
6. Depth extension frame
7. Transparent polycarbonate cover
8. Solid polyester closure plate
9. Polyurethane gasket

#### Optimal modular application

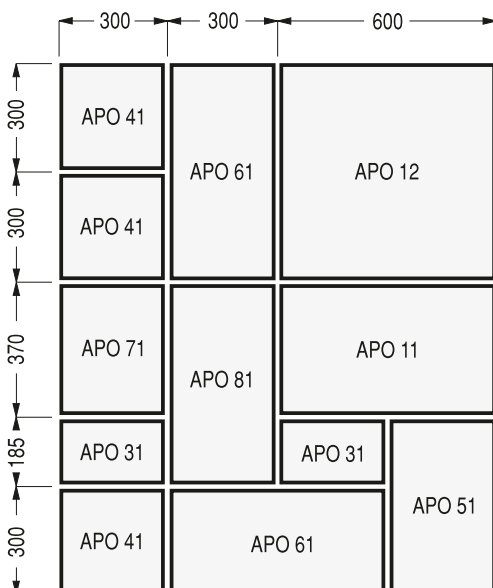

#### Technical data

Protection classification in accordance with IEC 60529		
Polyester cabinets	with 100% polyester cover	IP67
	with transparent polycarbonate cover	IP66
	with hinged cover	IP67
	Cabinet with rubber cable entry	IP43/54 <sup>(2)</sup>
	Cabinet combination(s)	IP67 <sup>(1)</sup>
	Cabinet with raised frame	IP66





(1) Depending on cover used

(2) IP54 if cable entry is mounted at the bottom of the cabinet.

## General purpose enclosures

### APO - Modular polyester boxes



	Type	APO 1	APO 31	APO 41	APO 71
 <p>Enclosure with polyester cover            □ IP67            Solid cover with securing screws</p>	HxWxD	186x151x140	302x186x175	302x302x175	300x300x175
	Type	AP1P	AP31P	AP41P	AP71P
	Order code	4TBO856048C0100	4TBO856049C0100	4TBO856050C0100	4TBO856051C0100
 <p>Enclosure with polycarbonate cover:            □ IP66            Transparent cover with securing screws</p>	HxWxD	185x151x140	300x185x175	300x300x175	370x300x175
	Type	AP1T	AP31T	AP41T	AP71T
	Order code	4TBO856057C0100	4TBO856058C0100	4TBO856059C0100	4TBO856060C0100
 <p>Enclosure with pivoting cover            □ IP67            Transparent cover with clip-in buttons</p>	HxWxD		300x185x175	300x300x175	370x300x175
	Type	-	AP31THC	AP41THC	AP71THC
	Order code		4TBO856066C0100	4TBO856067C0100	4TBO856068C0100
 <p>Enclosure with hinged cover            □ IP55            Solid cover</p>	HxWxD	185x151x140	300x185x175	300x300x175	370x300x175
	Type	AP1PHC	AP31PHC	AP41PHC	AP71PHC
	Order code	4TBO856071C0100	4TBO856072C0100	4TBO856073C0100	4TBO856074C0100

Pack = 1

## General purpose enclosures

APO - Modular polyester boxes

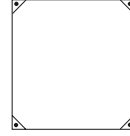

APO 51	APO 81	APO 61	APO 11	APO 12
488x302x175	558x302x175	602x302x175	603x372x175	603x603x175
AP51P	AP81P	AP61P	AP11P	AP12P
4TBO856052C0100	4TBO856053C0100	4TBO856054C0100	4TBO856055C0100	4TBO856056C0100

485x300x210	555x300x210	600x300x210	600x370x210	600x600x210
AP51T	AP81T	AP61T	AP11T	AP12T
4TBO856061C0100	4TBO856062C0100	4TBO856063C0100	4TBO856064C0100	4TBO856065C0100







485x300x175		600x300x175		
AP51THC	-	AP61THC	-	-
4TBO856069C0100		4TBO856070C0100		

485x300x175	555x300x175	600x300x175	600x370x175	600x600x175
AP51PHC	AP81PHC	AP61PHC	AP11PHC	AP12PHC
4TBO856075C0100	4TBO856076C0100	4TBO856077C0100	4TBO856078C0100	4TBO856079C0100

## General purpose enclosures

### APO - Modular polyester boxes

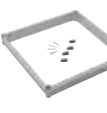
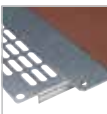

	Type	APO 1	APO 31	APO 41	APO 71	
	Base with solid walls	HxWxD	186 x 151 x 85	302 x 186 x 131	302 x 302 x 131	372 x 302 x 131
		Type	AP1B	AP31B	AP41B	AP71B
		Order code	4TBO856000C0100	4TBO856001C0100	4TBO856002C0100	4TBO856003C0100
		Pack	4	4	1	4
	Base with 2 open walls	HxWxD		302 x 186 x 131	302 x 302 x 131	372 x 302 x 131
		Type	-	AP31B2	AP41B2	AP71B2
	The dimensions with shading are those of the open walls	Order code		4TBO856009C0100	4TBO856010C0100	4TBO856011C0100
		Pack		4	4	4
	Base with 4 open walls	HxWxD		302 x 186 x 131	302 x 302 x 131	372 x 302 x 131
		Type	-	AP31B4	AP41B4	AP71B4
		Order code		4TBO856017C0100	4TBO856018C0100	4TBO856019C0100
		Pack		4	4	4
	Polyester cover	HxWxD	186 x 151 x 45	302 x 186 x 45	302 x 302 x 45	372 x 302 x 45
		Type	AP1PC	AP31PC	AP41PC	AP71PC
	Solid cover including securing screws	Order code	4TBO856025C0100	4TBO856026C0100	4TBO856027C0100	4TBO856028C0100
		Pack	4	4	4	4
	Polycarbonate cover	HxWxD	186 x 151 x 45	302 x 186 x 45	302 x 302 x 45	372 x 302 x 45
		Type	AP1TC	AP31TC	AP41TC	AP71TC
	Transparent cover with securing screws	Order code	4TBO851196C0100	4TBO851173C0100	4TBO851277C0100	4TBO851176C0100
		Pack	4	4	4	4
	Pivoting cover	HxWxD		302 x 186 x 35	302 x 302 x 45	372 x 302 x 45
	Transparent cover with clip-in buttons for the frame	Type	-	AP31STHC	AP41STHC	AP71STHC
		Order code		4TBO856034C0100	4TBO856035C0100	4TBO856036C0100
		Pack		4	4	4
	Depth extension frame	HxWxD	186 x 151 x 35	302 x 186 x 35	302 x 302 x 35	372 x 302 x 35
		Type	AP1DE	AP31DE	AP41DE	AP71DE
	Reinforced with PA6 polyamide glass fiber	Order code	4TBO856040C0100	4TBO856041C0100	4TBO856042C0100	4TBO856043C0100
		Pack	4	4	4	4
	Mounting plate	HxWxD	140 x 105	228 x 139	254 x 228	298 x 254
	Pertinax 5mm	Type	AP1MHP	AP31MHP	AP41MHP	AP71MHP
	Galvanized steel	Order code	4TBO851190C0100	4TBO851187C0100	4TBO851278C0100	4TBO851181C0100
	Sendzimir 2mm	HxWxD	134 x 99	249 x 134	249 x 249	319 x 249
		Type	AP1MS	AP31MS	AP41MS	AP71MS
	1.5 mm perforated plate	Order code	4TBO851191C0100	4TBO851188C0100	4TBO851279C0100	4TBO851185C0100
	(Slide nuts, see I.22)	HxWxD	134 x 99	249 x 134	249 x 249	319 x 249
		Type	-	AP31MSP	AP41MSP	AP71MSP
	Order code		4TBO852875C0100	4TBO852876C0100	4TBO852877C0100	
	Pack	1	1	1	1	



## General purpose enclosures

### APO - Modular polyester boxes

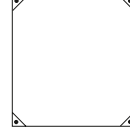

APO 51	APO 81	APO 61	APO 11	APO 12
488 x 302 x 131	558 x 302 x 131	603 x 302 x 131	603 x 372 x 131	603 x 603 x 131
AP51B	AP81B	AP61B	AP11B	AP12B
4TBO856004C0100	4TBO856005C0100	4TBO856006C0100	4TBO856007C0100	4TBO856008C0100
2	2	2	2	2
488 x 302 x 131	558 x 302 x 131	603 x 302 x 131	603 x 372 x 131	603 x 603 x 131
AP51B2	AP81B2	AP61B2	AP11B2	AP12B2
4TBO856012C0100	4TBO856013C0100	4TBO856014C0100	4TBO856015C0100	4TBO856016C0100
2	2	2	2	2
488 x 302 x 131	558 x 302 x 131	603 x 302 x 131	603 x 372 x 131	603 x 603 x 131
AP51B4	AP81B4	AP61B4	AP11B4	AP12B4
4TBO856020C0100	4TBO856021C0100	4TBO856022C0100	4TBO856023C0100	4TBO856024C0100
2	2	2	2	2
488 x 302 x 45	558 x 302 x 45	603 x 302 x 45	603 x 372 x 45	603 x 603 x 45
AP51PC	AP81PC	AP61PC	AP11PC	AP12PC
4TBO856029C0100	4TBO856030C0100	4TBO856031C0100	4TBO856032C0100	4TBO856033C0100
2	2	2	2	2
488 x 302 x 80	558 x 302 x 80	603 x 302 x 80	603 x 372 x 80	603 x 603 x 80
AP51TC	AP81CP	AP61TC	AP11TC	AP12TC
4TBO852092C0100	4TBO851193C0100	4TBO851282C0100	4TBO851290C0100	4TBO852280C0100
-	-	603 x 302 x 45	-	-
2	2	2	2	2
488 x 302 x 45	-	603 x 302 x 45	603 x 372 x 115	-
AP51STHC	-	AP61STHC	AP11STHC	-
4TBO856037C0100	-	4TBO856038C0100	4TBO856039C0100 <sup>(1)</sup>	-
2	-	2	2	-
-	558 x 302 x 60	603 x 302 x 60	603 x 372 x 60	603 x 603 x 60
-	AP81DE	AP61DE	AP11DE	AP12DE
-	4TBO856044C0100	4TBO856045C0100	4TBO856046C0100	4TBO856047C0100
-	2	2	2	2
413 x 254	484 x 254	528 x 254	528 x 324	555 x 555
AP51MHP	AP81MHP	AP61MHP	AP11MHP	AP12MHP
4TBO852091C0100	4TBO851170C0100	4TBO851286C0100	4TBO851289C0100	4TBO852174C0100
435 x 249	505 x 249	550 x 249	550 x 319	550 x 555
AP51MS	AP81MS	AP61MS	AP11MS	AP12MS
4TBO852095C0100	4TBO851171C0100	4TBO851287C0100	4TBO851292C0100	4TBO852178C0100
435 x 249	505 x 249	550 x 249	550 x 319	550 x 555
AP51MSP	-	-	-	-
4TBO852878C0100	-	-	-	-
1	1	1	1	1

(1) 4TBO856039C0100 2

Pivoting cover with deep frame



## General purpose enclosures

### APO - Accessories

Product	Type	Order code	Pack
<b>Polystyrene closure plates</b>			
PG/Metric specifications	Width		
4xM20/16 + 1xM32/25	185	APEP185 4TBO856096C0100	1
2xM32/25 + 3xM25/M20 + 4xM20/16	300	APEP35 4TBO856131C0100	1
9xM25/20	300	APEP31 4TBO856097C0100	1
2xM50/40 + 2xM25/	300	APEP32 4TBO856098C0100	1
13xM20/16	300	APEP33 4TBO856099C0100	1
3xM40/32 + 2xM20/16	300	APEP34 4TBO856100C0100	1
1xM40/32 + 10xM25/20	370	APEP371 4TBO856101C0100	1
13xM25/20	370	APEP372 4TBO856102C0100	1



Product	Type	Order code	Pack
<b>Solid polyester closure plates</b>			
	Width		
	185	APBP185 4TBO856103C0100	1
	300	APBP3 4TBO856104C0100	1
	370	APBP37 4TBO856105C0100	1

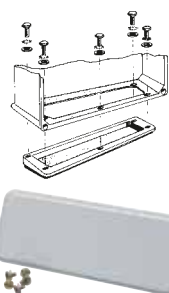

Dimensions for maximum cut-out, see Technical Guide

Product	Type	Order code	Pack
<b>Coupling frames</b>			
Made of glass fiber-reinforced polyamide.			
- Supplied with a template.			
- The slimmest section of the frame must be mounted toward the front of the base.			
- The maximum obtainable passage between two bases is that indicated by the template.			
The required number of openings may be applied within this space.			

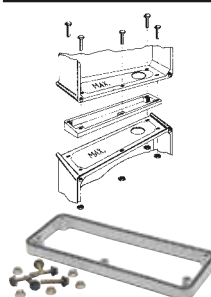

Width	Product	Type	Order code	Pack
185	APCF185	4TBO856106C0100	1	
300	APCF3	4TBO856107C0100	1	
370	APCF37	4TBO856108C0100	1	

Dimensions for maximum cut-out, see Technical Guide

For walls	Type	Cable max Ø (mm)	Number of clamps supplied	Made of polyester	Product	Order code	Pack
300	APO31	1 x 75	1	AP31CEB	4TBO856115C0100	1	
300	APO31	2 x 75	2	AP31CEB2	4TBO856116C0100	1	
300	APO41	1 x 75	1	AP41CEB	4TBO856117C0100	1	
300	APO61	1 x 75	1	AP61CEB	4TBO781936C0100	1	
300	APO71	1 x 71	1	AP71CEB	4TBO781937C0100	1	
370	APO71	3 x 75	1	AP71CEB2	4TBO856118C0100	1	



Dimensions, see Technical Guide

Product	Type	Order code	Pack
<b>Cable grip clamps<sup>(1)</sup></b>			
For attaching directly inside the cable end box.			
Cable max. Ø: 75mm			
Used on APO 31 and APO 71			
For 185, 300 and 370 mm enclosures			
AP31CC75	4TBO851105C0100	1	
Universal cable grip clamp			
Cable max. Ø: 75mm			
Used on APO 41			
For 300, 370 and 600mm enclosures			
AP41CC75	4TBO851110C0100	1	
Additional bracket for attaching to the clamp support.			
Cable max. Ø: 75mm			
APCC75	4TBO851111C0100	1	

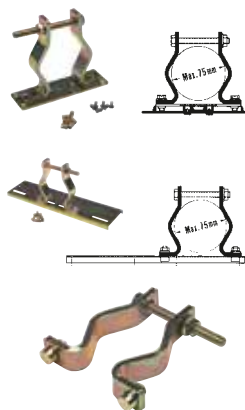



(1) See Technical Guide

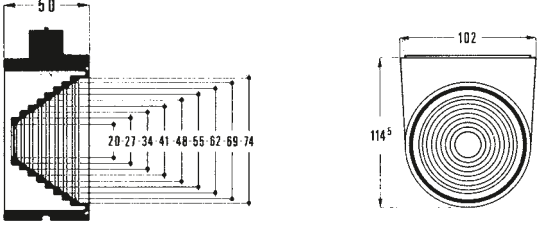

# General purpose enclosures

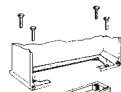
## APO - Accessories



Product	Type	Order code	Pack
<b>Rubber cable entry</b>			
- For direct mounting - Supplied with a template			
	APRCS	4TBO851106C0100	1
			
For creating cable end. Cable max. Ø: 75mm			

<b>Cable routing insert</b>			
Makes connecting large-section cables simple while maintaining the original level of protection.			
For 300mm side.			
	APBR3	4TBO851103C0100	1
For 370mm side.			
	APBR37	4TBO851112C0100	1
			

<b>Locks<sup>(1)</sup></b>			
Supplied with drilling template and mounting accessories.			
Handle with 2 keys V2432E			
	APL2432E	4TBO852020C0100	1
(1) Not for use with pivoting cover			

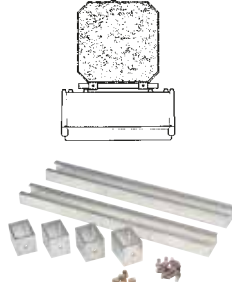
Product	Type	Order code	Pack
<b>IP44 Vent</b>			
Install 2 vents per enclosure for ventilation to prevent the formation of condensation. Supplied with a template and fixings. Recommended installation: one vent at the highest and lowest points on each side of the enclosure.			
Set of 2 polyamide pieces. RAL 7035			
	PS833677	4TBP833677C0100	1
			

<b>Pedestal mounting</b>			
- The C profiles are mounted directly to the rear of the base using the bosses provided. - The brackets may be distributed along the length of the C profile according to the width of the pedestal.			
Set of 2 C profiles and screws. For enclosure 300 and 370mm side.			
	APPM	4TBO890510C2100	1

<b>Fixing lugs</b>			
Set of 4 supports and screws, in glass fiber-reinforced polyamide.			
- For external mounting points. - Direct mounting through the 4 corner holes of the enclosure. - If using depth extension frames, first attach the supports. - Max equipment weight: 100kg.			
	APMBPA	4TBO851266C0100	1
			

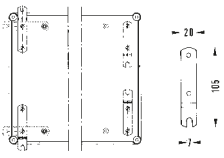
<b>Set of 4 stainless supports and screws (304-type)</b>			
- For very severe operating conditions. - The 4 brackets are mounted directly onto the rear of the base in the section that is reinforced for this purpose. - Mounting by means of M4 threaded inserts (provided). - Max equipment weight: 100kg.			
	APMBRVS	4TBO852025C0100	1
			

# General purpose enclosures

## APO - Accessories

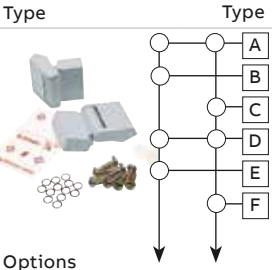

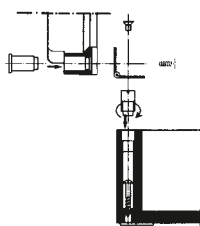
Product	Type	Order code	Pack
<b>Hinges</b>			
Type	Type	Hinges	
	A	A	
	B	B	
	C	C	
	D	D	
	E	E	
	F	F	
Options table	Back box		
	APO 31-41-71-51	- If hinges are to be installed, the cover and the base or the depth extension frame must be drilled. Drilling templates are provided; the type to be used will obviously depend on the combination selected.	
	81-61-11-12	- As a result, there is a range of 6 kits comprising 2 hinges, fixing hardware, drilling template, instructions and optional reinforcement plates.	
Polyester cover	A	A	
Polyester cover + depth extension frame	B	C	
Polycarbonate cover	D	D	
Polycarbonate cover + depth extension frame	E	F	

Product	Type	Order code	Pack
<b>Stainless hinges</b>			
	Set of 2 steel hinges (complete with accessories)	APHRVS	4TBO851268C0100 1
	For installation, the cover must be milled along the dotted line to a depth of 6 mm (see diagram).		

Product	Type	Order code	Pack
<b>Cover screws</b>			
	Cover screws	APCS	4TBO851255C0100 50

Product	Type	Order code	Pack
<b>Clip-in button</b>			
	Set of 2 pieces	APCS2	4TBO851258C0100 1

Product	Type	Order code	Pack
<b>Strip hinges</b>			
	Set of 2 pieces	APHS	4TBO851256C0100 1
	Warning: the base must be secured before mounting strip hinges.		

Product	Type	Order code	Pack
<b>Blanking screws with triangular head (TTR)</b>			
For fixed cover			
	Set of 2 pieces	APHSTTR	4TBO851262C0100 1
For pivoting cover			
	Set of 2 pieces	APHSTTRD	4TBO852016C0100 1

Product	Type	Order code	Pack
<b>Wrench</b>			
For triangular head screw (TTR)			
	APTTRK	4TBO851016C0100	1





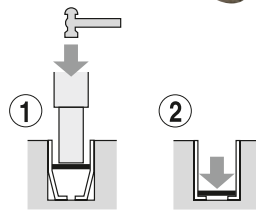





Product	Type	Order code	Pack
<b>Sealing plate</b>			
	Set of 2 pieces	APSP	4TBO851260C0100 1

Product	Type	Order code	Pack
<b>Padlock installation kit</b>			
	APPL	4TBO852004C0100	1
	Maximum shackle diameter: 8mm		

Product	Type	Order code	Pack
<b>Inserts</b>			
	M4 Dodge-type	APTIM4	4TBO851026C0100 100
	M6 Dodge-type x 12.5mm	APTIM6	4TBO851371C0100 100
	M4 punch	APTIM4T	4TBO851027C0100 1
	M6 punch	APTIM6T	4TBO852003C0100 1
			

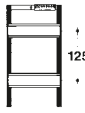
## General purpose enclosures

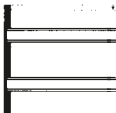
APO - Functions for modular equipment

Type	APO 31	APO 41	APO 71	APO 51	APO 61
					
	302 x 186	302 x 302	372 x 302	488 x 302	603 x 302
	14 modules	14 modules	28 modules	42 modules	42 modules
<b>Type</b>	AP31D141	AP41D141	AP71D282	APACC852283	AP61D423
<b>Order code</b>	4TBO851326C0100	4TBO851336C0100	4TBO851353C0100	4TBO852283C0100	4TBO851345C0100
					
	302 x 186	302 x 302	372 x 302		603 x 302
	14 modules	28 modules	36 modules		56 modules
<b>Type</b>	AP31D142	AP41D282	AP71D362		AP61D564
<b>Order code</b>	4TBO851330C0100	4TBO851338C0100	4TBO851358C0100		4TBO851347C0100

Functions for modular equipment

Includes:

- Bare chassis, equipped with a ground terminal and a front plate.
- Securing screws.
- 4 x 30mm rise pillars.

### Accessories

#### Module cover



Length: 72 mm  
Cut-out width: 45 mm  
Divisible by 9 mm sections

ZA3P5	4TBR610142C0200	5
FORSTBP500	4TBR610484C0200	500

Product	Type	Order code	Pack
---------	------	------------	------

#### Label holders



	Adhesive		
	APLB1M	4TBC851321C0100	1m

#### Connection busbars

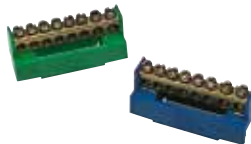

6 x 10 mm<sup>2</sup> + 2 x 16 mm<sup>2</sup>, Clip onto 12 x 2 mm rail



	Ground busbar - green		
	FORSTTPE	4TBR610186C0200	4
	Neutral busbar - blue		
	FORSTTN	4TBR610187C0200	1

## General purpose enclosures

APO - Stand-alone equipped boxes

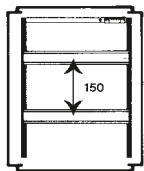
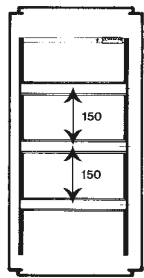
Type	APO 31	APO 41	APO 71	APO 61	APO 11
 <p>Boxes for modular equipment</p> <p>Includes:</p> <ul style="list-style-type: none"> <li>- base with two open sides</li> <li>- with combi cable glands top: 13xM20/16 bottom: 2xM32/25 + 3xM25/20 + 4xM20/16</li> <li>- bare chassis, equipped with a ground terminal and a front plate</li> <li>- transparent pivoting cover</li> </ul>					
	186 x 302 x 175		372 x 302 x 175	603 x 302 x 175	
	14 modules		28 modules	42 modules	
<b>Type</b>	AP31DIN1		AP71DIN2	AP61DIN3	
<b>Order code</b>	4TBO856119C0100		4TBO856120C0100	4TBO856121C0100	

## General purpose enclosures

### APO 61 - □ IP44-IK10 distribution enclosures



APO 61

- Made from polyester, self-extinguishing reinforced with glass fiber.
- Meet AREI requirements.
- Equipped with a circuit breaker for circuit protection.
- Also equipped with a 300 mA differential switch for general protection.
- Distribution cabinets are equipped with wall mounting lugs.
- Wired and equipped with a sufficiently sized entry.
- May be coupled to a meter enclosure.
- 3 x 230 V/3 x 400 V+N network inverter.
- Dimensions: 600x300x175mm

#### Distribution enclosures with industrial and domestic power outlets

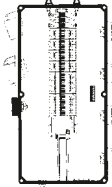
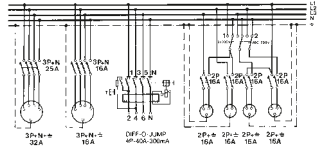
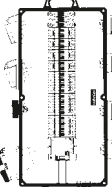
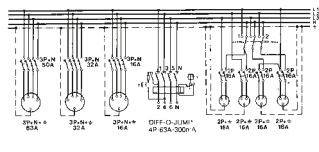
	Equipment	Single-line diagram	Type	Order code
<b>32 A type</b> 	1 x 32 A 5P 6h 400 V EEC power outlet 1 x 16 A 5P 6h 400 V EEC power outlet 4 x power outlets with ground braid and child safety function. Inverter 3P+N 400V / 3x230 V  Protection: 1 Diff-o-Jump type A 4P 40 A 300 mA 1 6 kA 3P+N 25 A Car. C. circuit breaker 1 x 6 kA 3P+N 16 A car. C. circuit breaker 4 x 6kA 2P 16 A car. C circuit breaker		AP61BWK32AH	4TBO890501N2100
<b>63 A type</b> 	1 x 63 A 5P 6h 400 V EEC power outlet 1 x 32 A 5P 6h 400 V EEC power outlet 1 x 16 A 5P 6h 400 V EEC power outlet 4 x power outlets with ground braid and child safety function. Inverter 3P+N 400V / 3x230 V  Protection: 1 Diff-o-Jump type A 4P 63A 300 mA 1 6 kA 3P+N 50A Car. C. circuit breaker 1 x 6 kA 3P+N 32A car. C. circuit breaker 1 x 6 kA 3P+N 16 A car. C. circuit breaker 4 x 6kA 2P 16 A car. C circuit breaker		AP61BWK63AH	4TBO890502N2100

#### Distribution enclosures with industrial power outlets

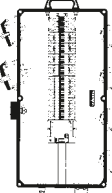
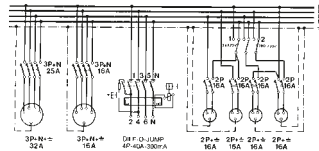
	Equipment	Single-line diagram	Type	Order code
<b>32 A type</b> 	1 x 32 A 5P 6h 400 V EEC power outlet 1 x 16 A 5P 6h 400 V EEC power outlet 4 x 16 A 3P 6h 400 V EEC power outlets Inverter 3P+N 400V / 3 x 230 V  Protection: 1 Diff-o-Jump type A 4P 40 A 300 mA 1 6 kA 3P+N 25 A Car. C. circuit breaker 1 x 6 kA 3P+N 16 A car. C. circuit breaker 4 x 6kA 2P 16 A car. C circuit breaker		AP61BWK32AIND	4TBO890505N2100

# General purpose enclosures

## APO - Dimensional drawings - Bases

**APO 1**

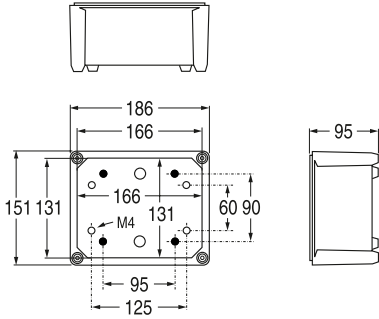

**APO 71**

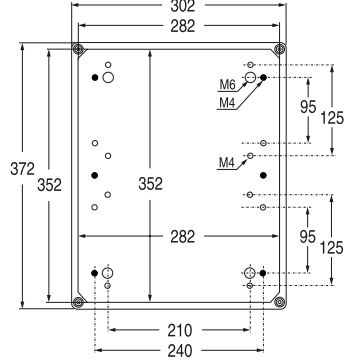

**APO 51**

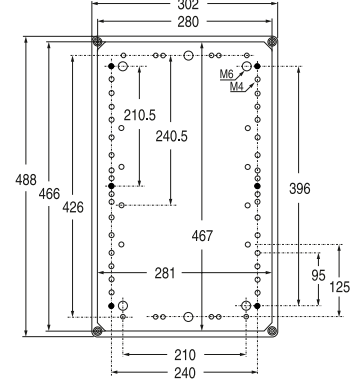

**APO 31**

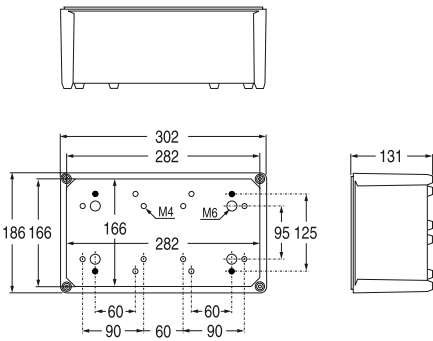

**APO 81**

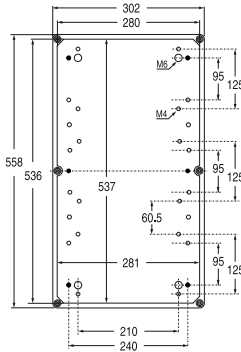

**APO 41**

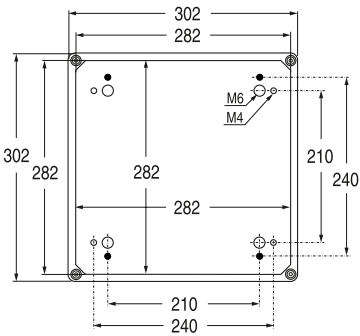

**APO 61**

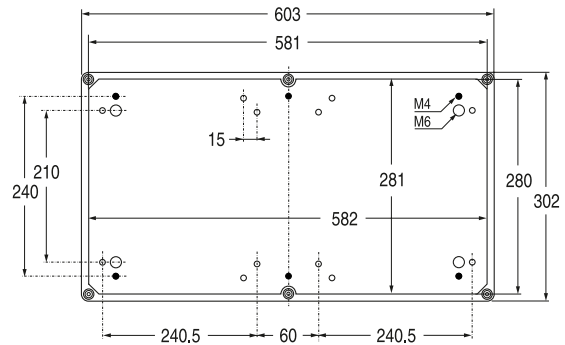

**APO 11**

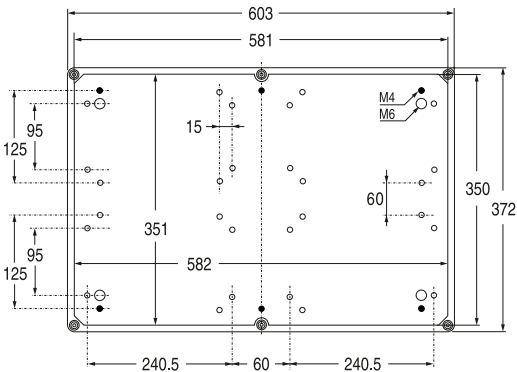

**APO 12**

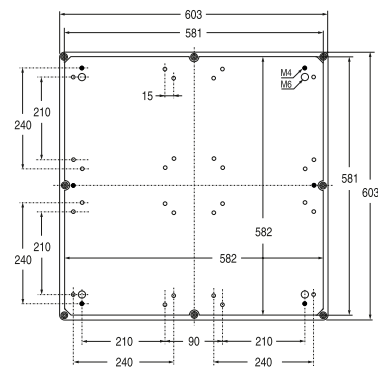

● = insert standard delivered in APO boxes (base + cover)

○ = with insert M4 or M6



# General purpose enclosures

## APO - Dimensional drawings for mounting

**Boxes**

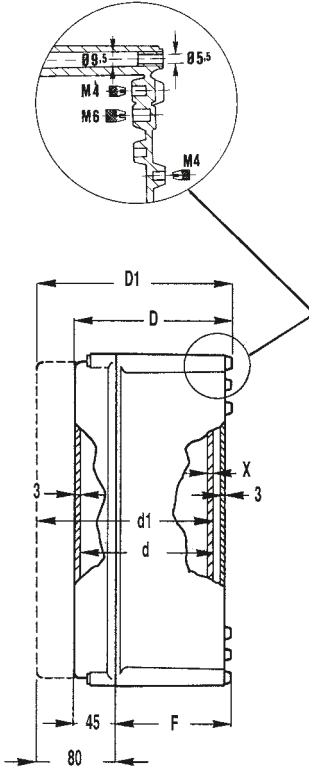
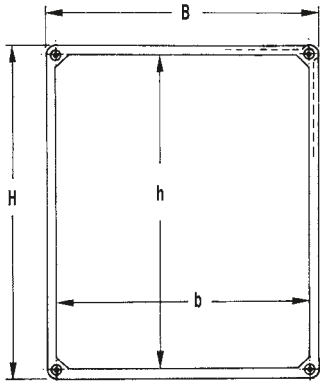

**Wall mounting**

Direct to the wall

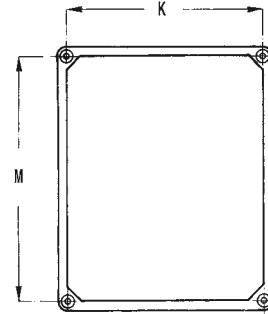

With stainless steel mounting brackets

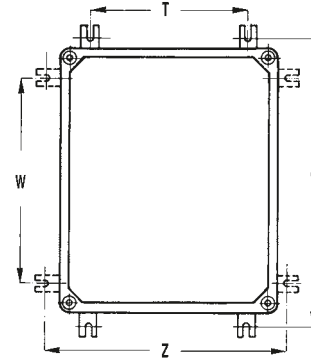

**Transparent hinged cover**

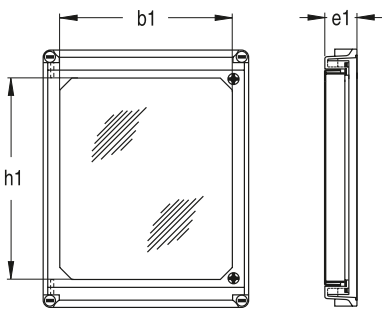

**APO 11**  
Hinged cover with side flange

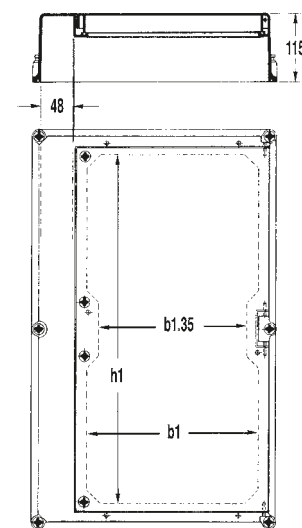

With polyamide mounting brackets

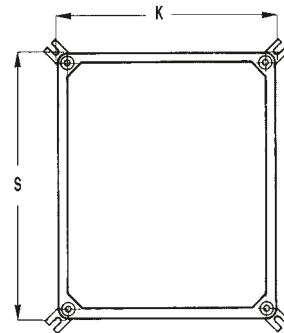

**Dimensions**

H	B	D	D1	h	b	d	d1	F	h1	b1	e1	Type	K	M	R	S	T	V	W	Z
186	151	140	-	166	131	118-X	-	95	-	-	-	<b>APO 1</b>	131	166	155	190	-	-	-	-
302	186	175	-	282	166	150-X	-	130	110	260	45	<b>APO 31</b>	282	166	190	306	125	312	241	197
302	302	175	-	282	282	150-X	-	130	225	260	45	<b>APO 41</b>	282	282	306	306	241	313	241	313
372	302	175	-	352	282	150-X	-	130	295	260	45	<b>APO 71</b>	282	352	376	306	241	383	311	313
488	302	175	210	467	281	150-X	185-X	130	410	260	45	<b>APO 51</b>	280	466	490	304	241	499	427	313
558	302	175	210	537	281	150-X	185-X	130	-	-	-	<b>APO 81</b>	280	536	561	305	241	569	497	313
603	302	175	210	582	281	150-X	185-X	130	525	260	45	<b>APO 61</b>	280	581	606	305	241	614	542	313
603	372	175	210	582	351	150-X	185-X	130	525	260	115	<b>APO 11</b>	350	581	606	374	311	614	542	383
603	603	175	210	582	582	150-X	185-X	130	-	-	-	<b>APO 12</b>	581	581	605	605	542	614	542	614

X = thickness of mounting plate

### General purpose enclosures

APO - Dimensional drawings - Cut-outs in side panels

Side 185

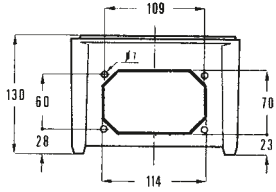

Side 300

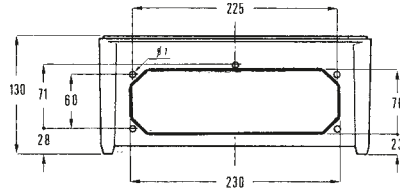

Side 370

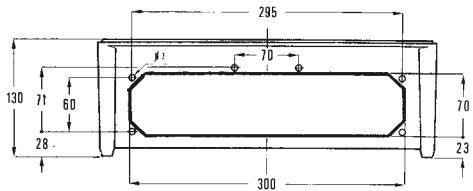

Side 485

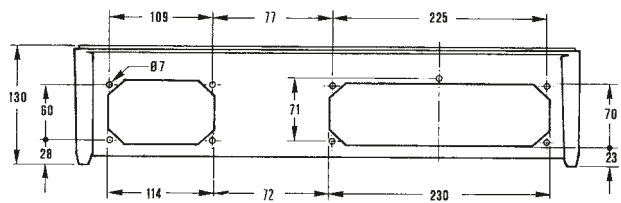

Side 555

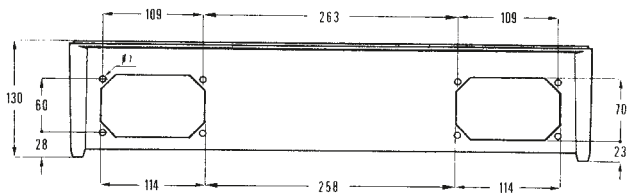

Side 600

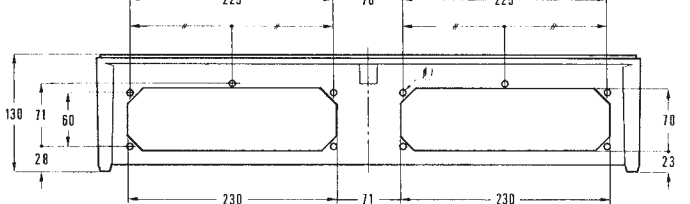

**General purpose enclosures**

APO - Dimensional drawings - Cable-end boxes

**APO 31**  
1 entry

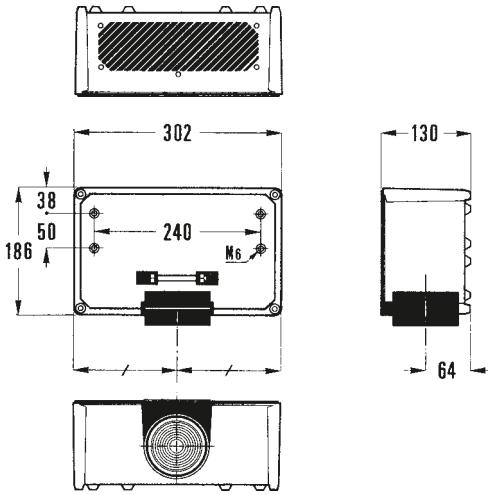

2 entries

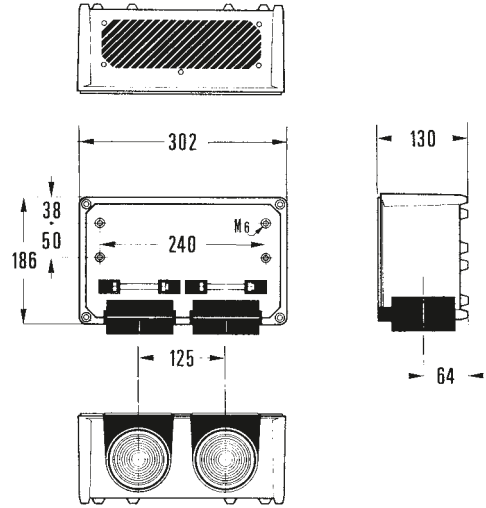

**APO 41**  
1 entry

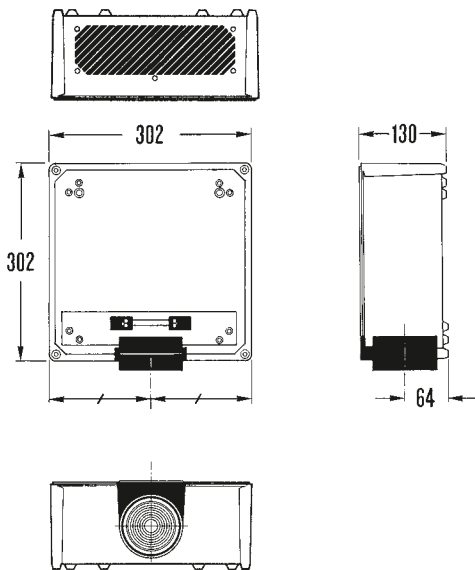

**APO 71**  
3 entries

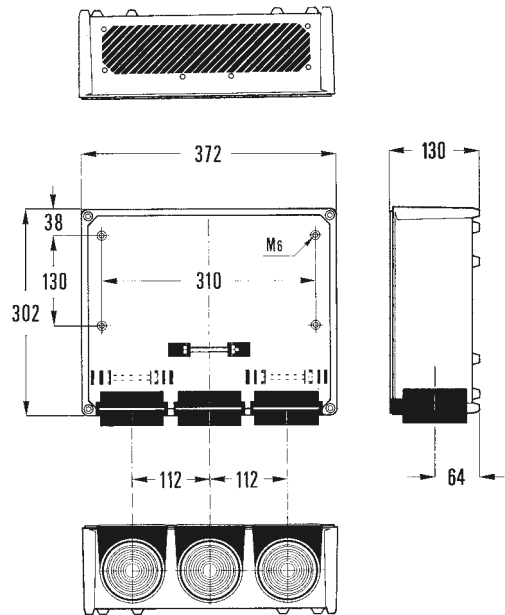





—  
03

VMS

<b>VMS</b>	
Modular system	40
Features and benefits	42
Technical data	44
Modular system components	45
Accessories	46
Supporting frame for wall mounting	49
Supporting frame for floor standing	50
Modular insulated enclosures	51
Busbar system	53
Busbar system 125 A–1 250 A	54
Parallel busbar arrangement	57
Bases	58
Busbar supports	61
Power dissipation values	62

---

## General purpose enclosures

### VMS - Modular system



#### Applications

- Manufacturing
- Public works
- Controls for motors
- Electronic instrumentation
- Low-voltage distribution boards

**Standard: EN / IEC 61439-2, EN / IEC 60529, EN / IEC 62208**

#### Specifications

- The range comprises five base dimensions, multiples of the 100 mm module.
- The ingenious and unique coupling system makes assembly simple and quick, for any combination of enclosures without the need for any tooling.
- The open base affords excellent options for cabling and installation for the connection, even when already coupled.
- The open sides can easily be fitted with smooth walls or walls with cutouts without impacting the protection ratings.
- Each large base is a multiple of smaller bases. The equipment securing points are inset by 25 mm increments, at the top and bottom of the base.
- The base and the closure plates are made from glass fiber-reinforced polycarbonate, halogen-free, self-extinguishing, light gray dyed in the mass (RAL 7035) color. The cover is fabricated from transparent or light gray (RAL 7035) polycarbonate.
- A comprehensive range of closure and mounting plates meeting a wide range of requirements for all installations.
- VMS enclosures are halogen-free.
- Enclosures offer maximized protection to users and equipment thanks to their double insulation  $\square$  and IP65 protection rating in accordance with the EN/IEC 60529 standard.



## General purpose enclosures

### VMS - Modular system

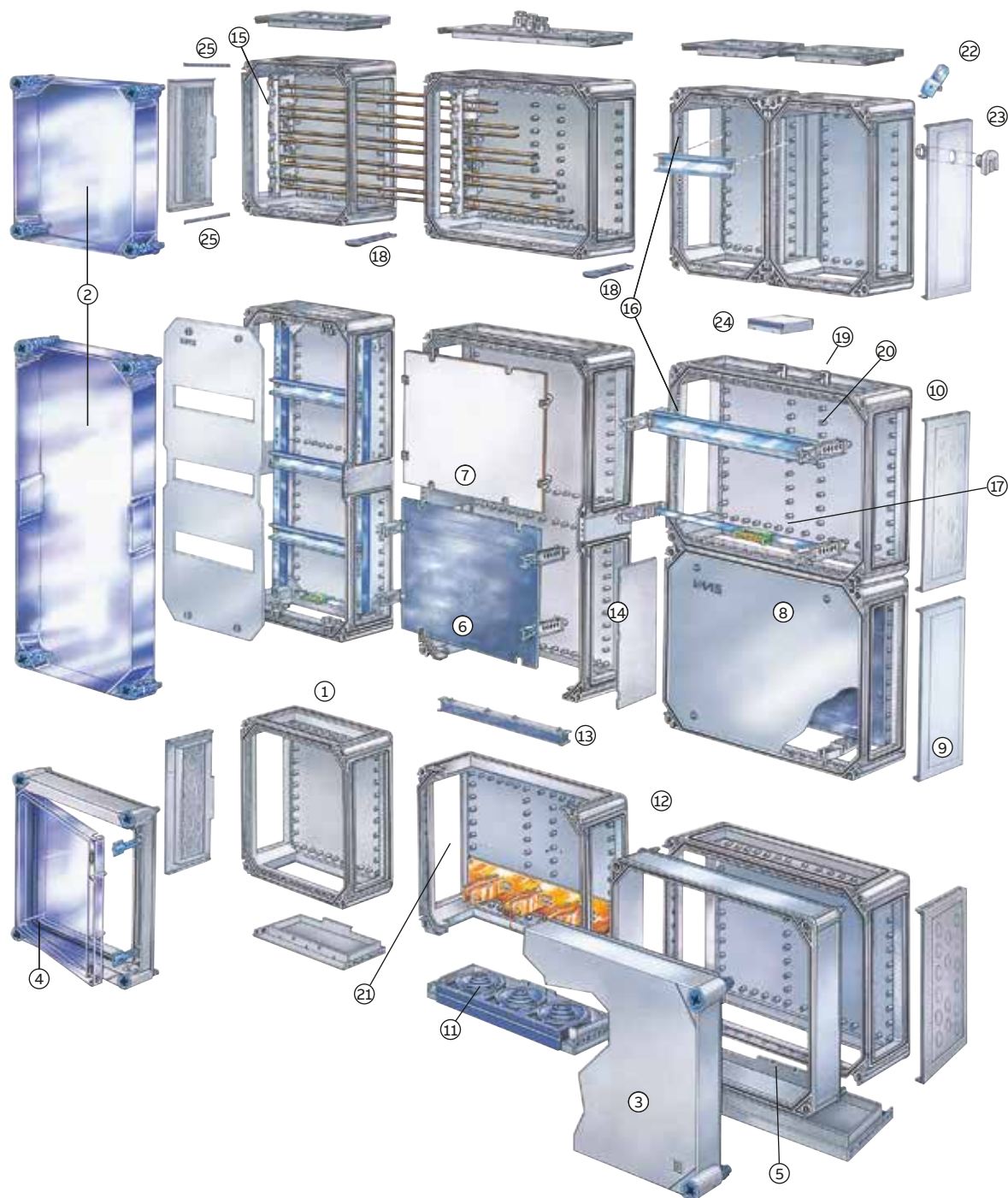

1. Back box
2. Transparent cover
3. Opaque cover
4. Pivoting cover
5. Depth extension frame
6. Mounting plate: metal
7. Mounting plate: pertinax

8. Solid cover panel
9. Closure plate
10. Closure plate with punch-out
10. Closure plate with cable entry
11. Cable grip support
12. Cable grip support
13. Cross member
14. Partition plate

15. Busbar support
16. DIN-profile
17. Mounting rail 12x2 mm
18. Coupling dowels
19. Coupling clamp
20. Universal support
21. Stress-relieving cable clamp

22. Fixing bracket
23. Air vent
24. Coupling set 2x220 mm
25. Locking key

## General purpose enclosures

### VMS - Features and benefits



Modular dimensions in increments of 100mm in height and width, available in five sizes:

320×220 mm	320×320 mm
440×320 mm	640×320 mm
640×440 mm	



Assorted covers: transparent, opaque, or hinged; common design and depth.

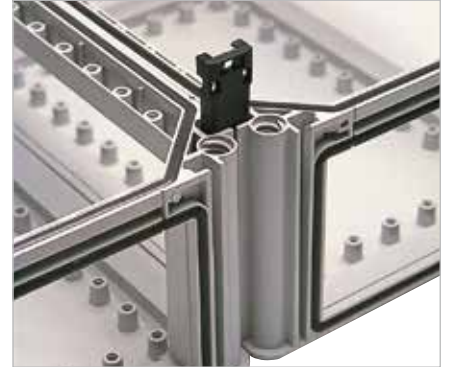

Quick coupling thanks to the vertical dowels inserted into the four corner slots of the boxes.



Combi or blind plates are snapped on from the outside and fixed by means of vertically sunk keys at the front of the base.



After installation, the end-plates fit perfectly into the side panels of the base.

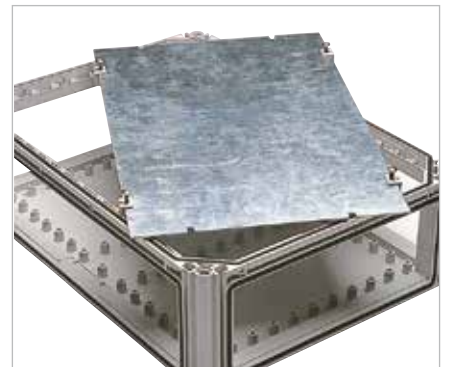

Mounting plates (2 mm in metal or 5mm in insulating material (pertainax), with mounting accessories).



Universal support for screwless and depth adjustable installation of component rails. This universal support is simply clicked over the base.



Removable bridges facilitate the introduction of large-section cables. After connecting the cables, insert the bridges (320 and 440 mm sides).

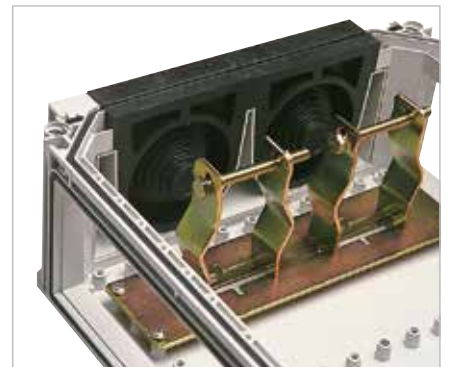

Universal cable entries and stress-relieving cable clamps to Ø 75 mm are attached to all base on side 320 mm (for 2 cables) and side 440 mm (for 3 cables).

---

## General purpose enclosures

### VMS - features and benefits

#### Vertical and horizontal stacking of enclosures

Enclosures are assembled using dowel pins mounted on the front end. The dowel pins are universal for the entire range of VMS enclosures.

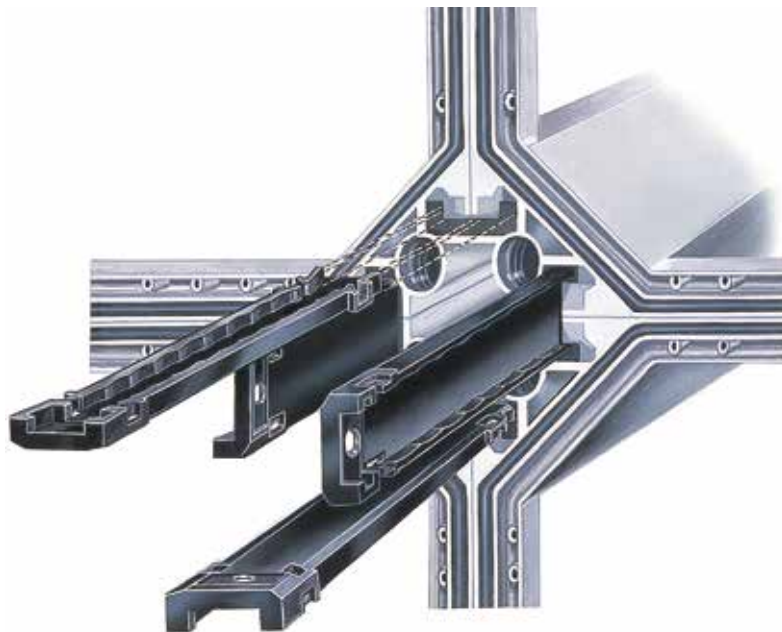

#### Installation of closure plates

After insertion from outside, the closure plate is locked in position by two dowel pins and pressed against the enclosure body join.



## General purpose enclosures



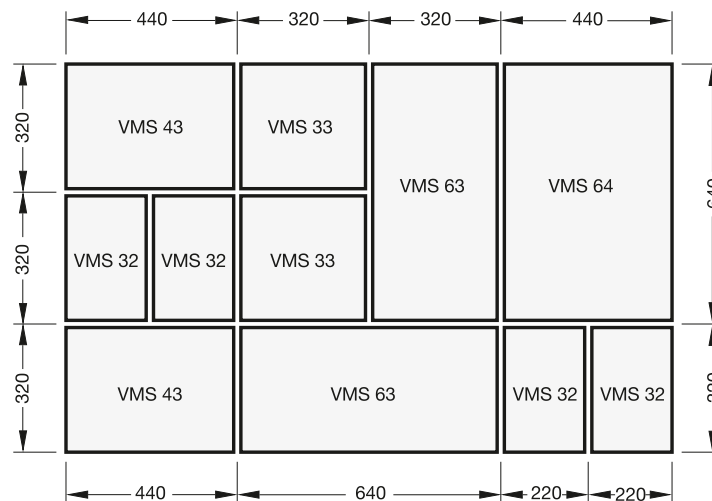

### VMS - Technical data

<b>Degree of protection according to IEC 60529</b>	
individual and coupled	IP65
with coupling set 2 x 220	IP44
with extension frame	IP65
with cable entries	IP43
with bridges	IP55
<b>Protection degree against external mechanical impacts according to EN 62262 and IEC 62262</b>	
base + end plates + covers	IK08
hinged cover	IK06
<b>Materials</b>	
base + end-plates	Reinforced fiber-glass polycarbonate
covers	Polycarbonate
cover screws	Polyamide
gasket	PUR, neoprene
<b>Temperature resistance</b>	
materials	See page 158–159
continuous use	-20 °C up to +80 °C
<b>Colours</b>	
base + end-plates	RAL 7035
covers	RAL 7035 / transparent
Protection	Total isolation <input type="checkbox"/>
Rated voltage	690 V AC / 800 V DC
Rated insulation voltage	690 V AC
Rated current	max. 1250 A
Rated short time withstand current	max. 30 kA (0.3 s.)
Rated peak short-circuit current	max. 65 kA peak
Standards	EN 61439-2, DIN VDE 0660, IEC 61439-2

### Optimal modular application







### VMS - Range overview

IP65 VMS (modular)				
				
320×220×179 mm	320×320×179 mm	440×320×179 mm	640×320×179 mm	640×440×179 mm

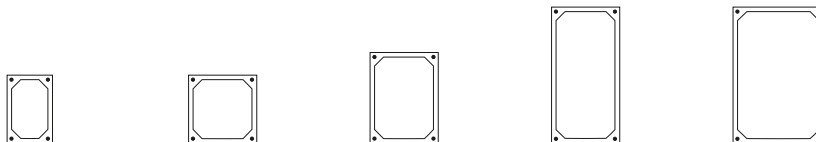
## General purpose enclosures

### VMS - Modular system components





	Type	VMS 32	VMS 33	VMS 43	VMS 63	VMS 64	
	<b>Back box</b>	H×W×D	320×220×130	320×320×130	440×320×130	640×320×130	640×440×130
	With four open sides	<b>Type</b>	V32BWNJ6	V33BWNJ6	V43BWNJ6	V63BWNJ6	V64BWNJ6
		<b>Order code</b>	4TBV853000C0100	4TBV853001C0100	4TBV853002C0100	4TBV853003C0100	4TBV853004C0100
		<b>Emb.</b>	4	2	2	1	1
	<b>Cover transparent</b>	H×W×D	320×220×50	320×320×50	440×320×50	640×320×50	640×440×50
	With slotted screws	<b>Type</b>	V32CTNJ6	V33CTNJ6	V43CTNJ6	V63CTNJ6	V64CTNJ6
		<b>Order code</b>	4TBV853005C0100	4TBV853006C0100	4TBV853007C0100	4TBV853008C0100	4TBV853009C0100
		<b>Emb.</b>	4	2	2	1	1
	<b>Cover solid</b>	H×W×D	320×220×50	320×320×50	440×320×50	640×320×50	640×440×50
	With slotted screws	<b>Type</b>	V32CBNJ6	V33CBNJ6	V43CBNJ6	V63CBNJ6	V64CBNJ6
		<b>Order code</b>	4TBV853010C0100	4TBV853011C0100	4TBV853012C0100	4TBV853013C0100	4TBV853014C0100
		<b>Emb.</b>	4	2	2	1	1
	<b>Cover Hinged</b>	H×W×D	-	320×320×50	440×320×50	-	-
	With double closure system Opening at 215°	<b>Type</b>	-	V33CPNJ6	V43CPNJ6	-	-
		<b>Order code</b>	-	4TBV853015C0100	4TBV853016C0100	-	-
		<b>Emb.</b>	-	2	2	-	-
	<b>Depth extension frame</b>	H×W×D	320×220×75	320×320×75	440×320×75	640×320×75	640×440×75
	With fixing screws	<b>Type</b>	V32WDNJ6	V33WDNJ6	V43WDNJ6	V63WDNJ6	V64WDNJ6
		<b>Order code</b>	4TBV853030C0100	4TBV853031C0100	4TBV853032C0100	4TBV853033C0100	4TBV853034C0100
		<b>Emb.</b>	4	2	2	1	1
	<b>Metal mounting plate, 2mm</b> With mounting set	H×W×D	260×160	260×260	380×260	580×260	580×380
		<b>Type</b>	V32MWNJ6	V33MWNJ6	V43MWNJ6	V63MWNJ6	V64MWNJ6
		<b>Order code</b>	4TBV853068C0100	4TBV853069C0100	4TBV853070C0100	4TBV853071C0100	4TBV853072C0100
	<b>Pertinax, 5mm</b> With mounting set	H×W×D	260×160	260×260	380×260	580×260	580×380
		<b>Type</b>	V32IWNJ6	V33IWNJ6	V43IWNJ6	V63IWNJ6	V64IWNJ6
		<b>Order code</b>	4TBV853113C0100	4TBV853114C0100	4TBV853115C0100	4TBV853116C0100	4TBV853117C0100
	<b>Solid cover plate Grey (RAL7035)</b> Insulated material, 2mm With mounting set	H×W×D	301×201	301×301	421×301	621×301	621×421
		<b>Type</b>	V32PWNJ7	V33PWNJ7	V43PWNJ7	V63PWNJ7	V64PWNJ7
		<b>Order code</b>	4TBV853103C0100	4TBV853104C0100	4TBV853105C0100	4TBV853106C0100	4TBV853107C0100
		<b>Emb.</b>	1-10	1-10	1-10	1-10	1-10

## General purpose enclosures

### VMS - Accessories

Closure plates		Metric sizes	Type	Order code	Verp.	Zijde
		3 x M32 / M25 + 3 x M20	VX2EWNJ7	4TBV855029C0100	1/10	220
		1 x M50 / M40 + 4 x M25 / M20	VX2EWNJ8	4TBV855030C0100	1/10	220
		3 x M50 / M40 + 4 x M16	VX3EWNJ9	4TBV855032C0100	1/10	320
		17 x M20	VX3EWNJ0	4TBV855033C0100	1/10	320
		1 x M50 / M40 + 2 x M32 / M25 + 4 x M25 / M20	VX3EWNJA	4TBV855034C0100	1/10	320
		12 x M25 / M20	VX3EWNJB	4TBV855035C0100	1/10	320
		4 x M40 / M32 + 3 x M20	VX3EWNJC	4TBV855036C0100	1/10	320
		1 x M40 / M32 + 16 x M25 / M20	VX4EWNJ8	4TBV855037C0100	1/10	440
		1 x M50 / M40 + 2 x M40 / M32 + 8 x M25 / M20	VX4EWNJ9	4TBV855038C0100	1/10	440

Product	Type	Order code	Pack
<b>Closure plates</b>			
	Side (mm) 220		
	VX2EWNJ6	4TBV853017C0100	1/10
	Side (mm) 320		
	VX3EWNJ6	4TBV853020C0100	1/10
Side (mm) 440			
VX3EWNJ7	4TBV853027C0100	1/10	

Plates with cable entries			
	Ø cable max.: 2 x 75 mm		
	Side (mm) 320		
	VX3EWNJ6	4TBV853082C0100	1/5
	Ø cable max.: 3 x 75 mm		
Side (mm) 440			
VX4EWNJ6	4TBV853083C0100	1/5	

Cable grip support			
With a cable clamp Ø max.: 75mm			
	Side (mm) 320		
	VX3LWNJ6	4TBV853036C0100	1/5
	Side (mm) 440		
	VX4LWNJ6	4TBV853037C0100	1/5

Stress-relieving cable clamp			
For fixing on the cable clamp support			
	Ø cable max.: 75mm		
	VXXLWNJ6	4TBV853035C0100	1

Bridges			
Facilitate the connection of large-section cables			
	Side (mm) 320		
	VX3AWNJ6	4TBV853073C0100	1
	Side (mm) 440		
	VX4AWNJ6	4TBV853074C0100	1

Coupling dowels			
	For base coupling		
	VXXAWNJ8	4TBV853059C0100	20

Product	Type	Order code	Pack
<b>Fixation pin</b>			
	For end-plates (as a spare part)		
	VXXEWNJ6	4TBV853055C0100	10

Coupling set 2 x 220			
	To couple two sides of 220mm to one side of 440mm With mounting accessories		
	VXXAWNJA	4TBV853063C0100	1







Coupling clamp			
	For coupling in special cases		
	VXXAWNJ9	4TBV853062C0100	10











Universal support			
	To fit:		
	- mounting plates and cover plates		
	- copper rails 15 x 3		
	- copper rails 9 x 6.5		
Barre plate 12 x 2mm			
VX3UWNJ6	4TBV853060C0100	10	

Marking strip			
	Self-adhesive		
	ZA10	2CPX038241R9999	1m

## General purpose enclosures

### VMS - Accessories

Product	Type	Order code	Pack
<b>Symmetrical DIN-profiles</b>			
Always supplied with two universal supports			
	Side (mm) 220		
	VX2AWNJ6	4TBV853094C0100	1
	Side (mm) 320		
	VX3AWNJ6	4TBV853095C0100	1
	Side (mm) 440		
	VX4AWNJ6	4TBV853096C0100	1
	Side (mm) 640		
	VX6AWNJ6	4TBV853269C0100	1
<b>Mounting rails 12 x 2mm</b>			
To fit connection terminal blocks. Always delivered with 2 universal supports.			
	Side (mm) 320		
	VX3AWNJ7	4TBV853098C0100	1
	Side (mm) 440		
	VX4AWNJ7	4TBV853099C0100	1
<b>Partition plates</b>			
For complete compartmentalization of coupled bases.			
	Side (mm) 220		
	VX2TWNJ6	4TBV853065C0100	1
	Side (mm) 320		
	VX3TWNJ6	4TBV853066C0100	1
	Side (mm) 440		
	VX4TWNJ6	4TBV853067C0100	1
<b>Fixing lugs</b>			
Set of 4 brackets with screws.			
<ul style="list-style-type: none"> <li>- In stainless steel.</li> <li>- For external fixing points.</li> <li>- Direct fitting through the four corner shafts of the base.</li> <li>- To be installed prior to the extension frame or hinge installation.</li> <li>- Three optional mounting positions (0°, 45°, 90°).</li> </ul>			
	VXXAWNJB	4TBV853064C0100	1
<b>Air vent - IP45</b>			
Installation of two air vents per box to obtain ventilation preventing the formation of condensation. Set of 2 pieces.			
	ACC818078	4TBJ818078R0100	1
<b>Blanking plate</b>			
For 12 modules			
	ZA1P5	2CPX062384R9999	5
	ZA1P50	2CPX062378R9999	50

Product	Type	Order code	Pack
<b>Cover screws</b>			
	Set of 4 pieces.		
	VXXCWNJ6	4TBV853057C0100	1
<b>Hinge screws</b>			
The base must be bed before fixed prior to hinge installation.			
Set of 2 pieces.			
	VXXHWNJ6	4TBV853061C0100	1
<b>Hinges made of molded material</b>			
To mount the hinges, the cover and the base must be pierced. Drilling templates are provided. The kit includes: two hinges, screws, reinforcement plates, drilling gage and instructions. Set of 2 pieces.			
	VXXHWNJ7	4TBV853340C0100	1
<b>Clip-in button</b>			
For cover screws or hinge screws. Set of 4 pieces.			
	VXXAWNJ7	4TBV853058C0100	1
<b>Clip-in button</b>			
For fixation in the base.			
5 x 13			
	VXXAWNJC	4TBV853100C0100	50
	5 x 16		
	VXXAWNJD	4TBV853101C0100	50
	5x22		
	VXXAWNJA	4TBV853102C0100	50
	To fix the equipment onto the metal mounting plates.		
<b>Screws for depth extension frame</b>			
Replacement parts			
	VXXDWNJ6	4TBV853056C0100	4
<b>Fixation set for cover plate</b>			
Replacement parts			
	VXXPWNJ7	4TBV853053C0100	1
<b>Fixation set for mounting plate</b>			
For metal or Pertinax			
Replacement parts			
	VXXIWNJ6	4TBV853054C0100	1

## General purpose enclosures

### VMS - Accessories

Product	Type	Order code	Pack
<b>Cover plate for DIN rail functions</b>			
	VMS33 2 rows For V33BWDJ6		
	V33PWNJ9	4TBV853327C0100	1
	VMS43 2 horizontal rows For V43BWDJ7		
	V43PWNJ9	4TBV853330C0100	1
	VMS63 2 horizontal rows For V63BWDJ6		
	V63PWNJ0	4TBV853333C0100	1
	VMS63 4 rows For V63BWDJ6		
	V63PWNJ9	4TBV853332C0100	1
	VMS64 4 rows For V64BWDJ6		
	V64PWNJ8	4TBV853334C0100	1

Product	Type	Order code	Pack
<b>Cover plate for fuse switch-disconnectors and for other components mounted on a 60mm rail system with screws.</b>			
	VMS 32 (Cut-out 195x135 mm)		
	V32PWNJ8	4TBV853173C0100	1
	VMS 33 pour V33BWHE5 (Cut-out 195x235 mm)		
	V33PWNJ8	4TBV853174C0100	1
	VMS 63 pour V33BWHE5 (Cut-out 195x240 mm 2 pieces)		
	V63PWNJ8	4TBV853176C0100	1



## General purpose enclosures

### VMS - Supporting frame for wall mounting

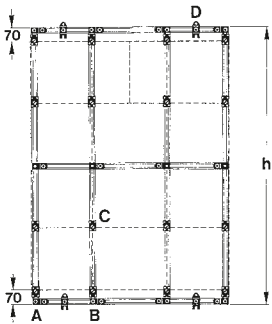

- Fixing small units onto the wall can be done using the stainless steel mounting brackets.
- To transport and fix units with more than five enclosures, the use of a frame is essential.
- The frame includes at least 2 horizontal C-profiles (of an equal length to the width of the unit) and vertical C-profiles (equal to the number of rows +1).
- If the unit exceeds a height of 1000mm, three horizontal C-profiles are required.
- The vertical C-profiles are 140mm longer than the height of the assembled panel.
- The frame and the unit are built simultaneously.



The horizontal and vertical C-profiles of the first row of enclosures are attached to each other by clamping brackets with sliding nuts. The following clamping brackets are mounted in the same way on the horizontal profile.

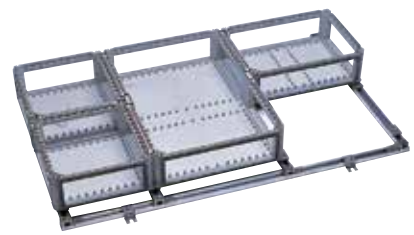

The following rows are mounted in the same way on the frame.



The first row of enclosures is then mounted on vertical profile with the clamping plates.

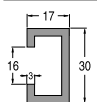

Frame and enclosure assemblies are mounted simultaneously.

Product	Type	Order code	Pack
<b>C-Profile in aluminum</b>			
	30 x 17 x 3mm Length = 3 m	APACC851254 4TBO851254C0100 1	

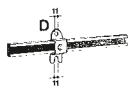
Product	Type	Order code	Pack
<b>Fixation plate</b>			
	Delivered with bolt and sliding nut. To fix the enclosures onto the vertical support profiles.	APACC851415 4TBO851415C0100 1	

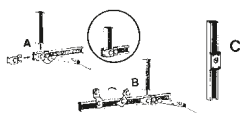
Product	Type	Order code	Pack
<b>Clamping bracket</b>			
	With bolts and two sliding nuts M8. To mount the upper and lower C-profiles to the vertical support-profiles	APACC851253 4TBO851253C0100 1	

Product	Type	Order code	Pack
<b>Clamping bracket</b>			
	To fix the enclosures onto the fixation plate.	APACC851249 4TBO851249C0100 1	

## General purpose enclosures

### VMS - Supporting frame for floor standing

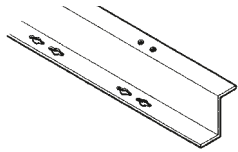
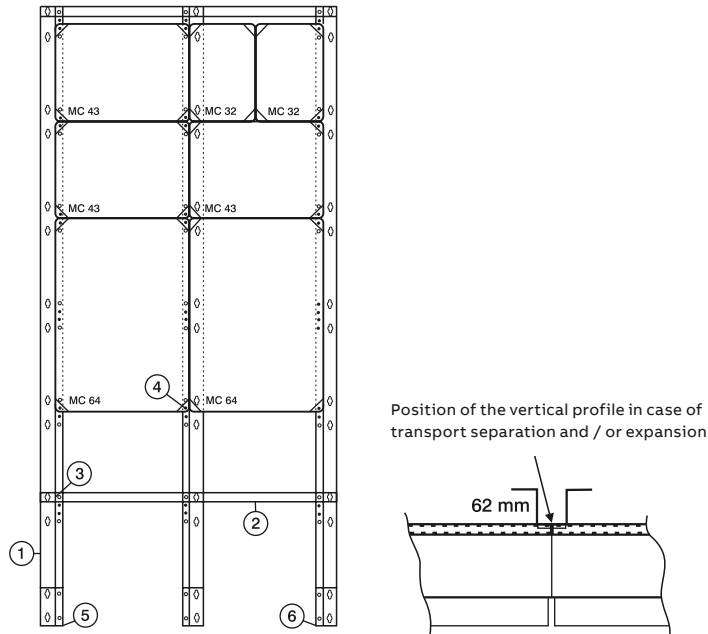

Z-Profile



C-Profile

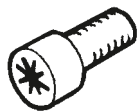

M5x16













Stand support

#### Accessories

	Type	Order code	Pack
<b>① Vertical Z-profile - RAL 9001</b>			
Aluzinc - L = 2 360 mm, for 6 × 320	VXXFWNJ7	4TBV855515C0100	
Aluzinc - L = 2 040 mm, for 5 × 320	VXXFWNJ8	4TBV855516C0100	
Aluzinc - L = 1 080 mm, for 3 × 320	VXXFWNJ9	4TBV855517C0100	
Aluzinc - L = 760 mm, for 2 × 320	VXXFWNJ0	4TBV855518C0100	1
<b>② Horizontal - C-profile</b>			
Length = 3 000 mm	ACC811619	4TBC811619C0100	1
<b>③ Fixation bracket</b>			
Fixing screw M5 × 16 mm to connect the vertical and horizontal profiles	VXXFWNJA	4TBV855519C0100	1
<b>④ Screw</b>			
M5×16 DIN 7500-C - TORX	VXXFWNJB	4TBV855520C0100	50
<b>Stand support</b>			
⑤ Left	VXXFWNJC	4TBV855521C0100	
⑥ Right	VXXFWNJD	4TBV855522C0100	1

## General purpose enclosures

### VMS - Modular insulated enclosures

Type	VMS 32	VMS 33	VMS 43	VMS 63	VMS 64
Enclosures for DIN equipment					
Without cover and combi end-plates for assembly of modular units.					
Includes:					
- base with four open sides					
- mounting frame with earth-rail and cover plate					
- earth terminal					
DIN rail distance 125mm	(horizontal)		(horizontal)	(horizontal)	(vertical)
	14 modules	28 modules	40 modules	56 modules	80 modules
<b>Type</b>	V32BWDJ6	V33BWDJ6	V43BWDJ7	V63BWDJ6	V64BWDJ6
<b>Order code</b>	4TBV853125C0100	4TBV853127C0100	4TBV853266C0100	4TBV853267C0100	4TBV853268C0100
			(vertical)	(vertical)	
			42 modules	56 modules	
<b>Type</b>			V43BWDJ6	V63BWDJ6	
<b>Order code</b>			4TBV853129C0100	4TBV853131C0100	

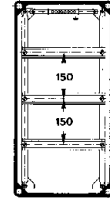
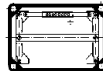

Enclosures for DIN equipment

Includes:

- base with four closed sides
- with combi end-plates:
  - at the top: 17 x M20
  - at the bottom: 1 x M50 / 40
  - + 2 x M40 / 32 + 8 x M25 / 20
- bare frame fitted with an earth terminal and cover plate
- transparent pivoting cover (VMS 43)
- transparent cover, attached with screws (VMS 32 - VMS 63)

	320 x 220 x 179 mm	440 x 320 x 179 mm	640 x 320 x 179 mm
	14 modules	28 modules	42 modules
<b>Type</b>	V32BTDJ7	V43BTDJ6	V63BTDJ7
<b>Order code</b>	4TBV853159C0100	4TBV853160C0100	4TBV853161C0100

Modular insulated enclosures with busbars

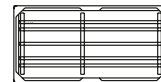

Without cover plates and entry plates\*.

With 250A / 400A

Rail system with 5 poles.



Without terminals.\*

	5P, 250 A	5P, 250 A
	MFR352	MFR652
<b>Type</b>	V33BWB E5	V63BWB E5
<b>Order code</b>	4TBV853252C0100	4TBV853253C0100

\* = for covers and plates see selection table at pages 45 and 46

## General purpose enclosures

### VMS - Modular insulated enclosures

Type	VMS 32	VMS 33	VMS 43	VMS 63	VMS 64
<b>Metering enclosures</b> Without cover and end-plates With installed meter board incl. meter fixation screws For covers and plates see selection table on pages 45 and 46					
			440 x 320 x 179 mm	640 x 320 x 179 mm	
<b>Type</b>			V43BWKJ6	V63BWKJ6	
<b>Order code</b>			4TBV853250C0100	4TBV853251C0100	

## General purpose enclosures

### VMS - Busbar system

#### Accessories

Product	Type	Order code	Pack
<b>Flat configuration 125A / 250A - Parallel arrangement 250A</b>			
	VXXSWNE5	4TBV853075C0100	10

<b>Flat configuration 125A / 250A - Parallel arrangement 400A</b>			
	VXXSWNF5	4TBV853076C0100	10

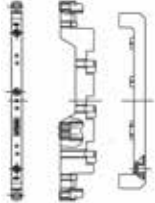



<b>Flat configuration 60mm</b>			
	160 up to 630A		
	VXXSW65	4TBV828322C0100	10

Product	Type	Order code	Pack
<b>Parallel arrangement 630A / 1100A</b>			
	5 pole 100%		
	VXBB855177N	4TBV855177C0100	10

<b>Rail connector</b>			
	1P, 630 A		
	VXXRWNG1	4TBV783267C0100	1

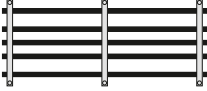
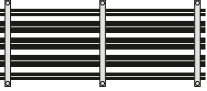
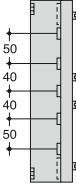
## General purpose enclosures

### VMS - Busbar system 125 A–1 250 A

	Flat configuration		Parallel arrangement	
				
				
Rated nominal current in	125/160 A		250A	250A
Busbar supports	VXXSWNE5			
Order code	4TBV853075C0100			
Pack	1	1	1	1
Center distance of phase bars (mm)	40	40	40	50
Distance between N or $\bar{\phi}$ and the closest phase (mm)	50	50	50	45
Busbars				
Number and dimensions of phase bars (L1 - L2 - L3)	1 x (12 x 5)	1 x (12 x 10)	2 x (12 x 5)	2 x (12 x 5)
Number and dimensions of bars N- $\bar{\phi}$	1 x (12 x 5)	1 x (12 x 5)	1 x (12 x 5)	2 x (12 x 5)
Section by phase (mm <sup>2</sup> )	60	120	120	120
Section by N - $\bar{\phi}$ (mm <sup>2</sup> )	60	60	60	120
Specifications				
Center distance of busbar supports (mm)	320	320	320	320
Dynamic short-circuit resistance (kA peak)	40	40	40	30
Dynamic short-circuit resistance (kA. eff.)	20	20	20	15

## General purpose enclosures

VMS - Busbar system 125 A–1 250 A

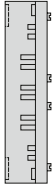

400A



630A



630A



1100A

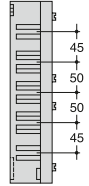

1100A

VXXSWNF5		VXXSWNI5		
4TBV853076C0100		4TBV853077C0100		
1	1	1	1	1
50	50	50	50	50
45	45	45	45	45
2 x (20x5)	2 x (20x10)	4 x (20x5)	2 x (30x10)	4 x (30x5)
2 x (12x5)	2 x (20x5)	2 x (20x5)	2 x (30x5)	2 x (30x5)
200	400	400	600	600
120	200	200	300	300
320	320/250	320/250	320	320
42	43.6/52.5	43.6/52.5	53	52.5
20	20.8/25	20.8/25	25	25

## General purpose enclosures

VMS - Busbar system 125 A–1 250 A

### Flat configuration

Product	Cable section		Clamp width X	Type	Order code	Pack
Cable-bar connection sockets 12×5 / 12×10						
Main bar width	(mm <sup>2</sup> )		(mm)	Cable clamp		
	Min.	Max.				
5	1.5	16	11.5	APACC858026	4TBO858026C0100	20
5	1.5	35	15.5	APACC858028	4TBO858028C0100	10
5	16	70	20.5	APACC858032	4TBO858032C0100	10
5	16	120	23.5	APACC858033	4TBO858033C0100	10
10	1.5	16	11.5	APACC858027	4TBO858027C0100	20
10	1.5	35	15.5	APACC858029	4TBO858029C0100	10
10	16	70	20.5	APACC858030	4TBO858030C0100	10
10	16	120	30.5	APACC858031	4TBO858031C0100	10





# General purpose enclosures

## VMS - Parallel busbar arrangement

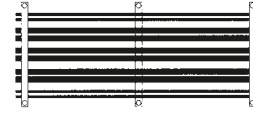
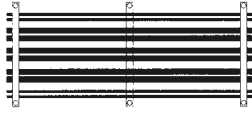

Type	Order code	Pack
------	------------	------

### Busbars with horizontal fixation

#### Connecting blocks

	For flat copper with widths of 25, 30 or 40	APACC858003 4TBO858003C0100 10
	For flat copper with widths of 20 or 25	APACC858004 4TBO858004C0100 10
	For flat copper with widths of 15 or 20	APACC858005 4TBO858005C0100 10



### Anchor bolts

#### For 5mm thick bars

	M10x6	APACC858008 4TBO858008C0100 10		
	M10x8	APACC858010 4TBO858010C0100 10		
For 10mm thick bars				
	M10x6	APACC858013 4TBO858013C0100 10		
	M10x8	APACC858011 4TBO858011C0100 10		
	<b>b</b>	<b>s</b>	<b>x</b>	<b>L</b>
	12	5	40	60
	12	10	45	60
	20	5	48	60
	20	10	53	60
	30	5	58	60
	30	10	63	80

Type	Order code	Pack
------	------------	------

### Cable-bar connection sockets - 16-35-70-120mm<sup>2</sup>

#### Wing contact block

	APACC858006 4TBO858006C0100 10
	APACC858007 4TBO858007C0100 10



### Anchor bolts

#### For 5mm thick rails

	M10x6	APACC858008 4TBO858008C0100 10		
	M10x8	APACC858010 4TBO858010C0100 10		
For 10mm thick rails				
	M10x6	APACC858013 4TBO858013C0100 10		
	M10x8	APACC858011 4TBO858011C0100 10		
	<b>b</b>	<b>s</b>	<b>x</b>	<b>L</b>
	12	-	42	60
	12	5	47	60
	12	10	52	60
	20	-	50	60
	20	5	55	60
	20	10	60	60
	30	-	60	60
	30	5	65	80
	30	10	70	80



### Koppelkit IP65 / IP54

#### Cable clamps for fixing to the contact block wings

Cable section mm <sup>2</sup>	Cable section mm <sup>2</sup>	Clamp width X (mm)	Type	Pack
1.5	16	11.5	APACC858026 4TBO858026C0100	20
1.5	35	15.5	APACC858028 4TBO858028C0100	10
16	70	20.5	APACC858032 4TBO858032C0100	10
16	120	23.5	APACC858033 4TBO858033C0100	10

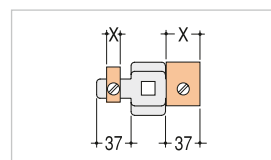

#### Legend:

- b: height of rectangular bars
- s: thickness of the rectangular bar or cable-shoe or flat copper
- x: minimum bolt length required
- L: length of fitting hook bolt or bolt with rectangular head

# General purpose enclosures technical details

## VMS – Dimensions

### Bases

VMS 32

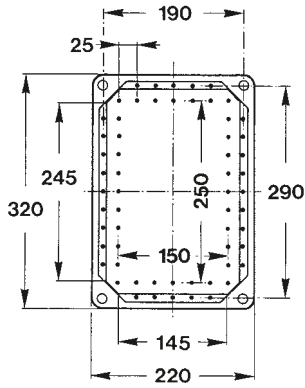

VMS 63

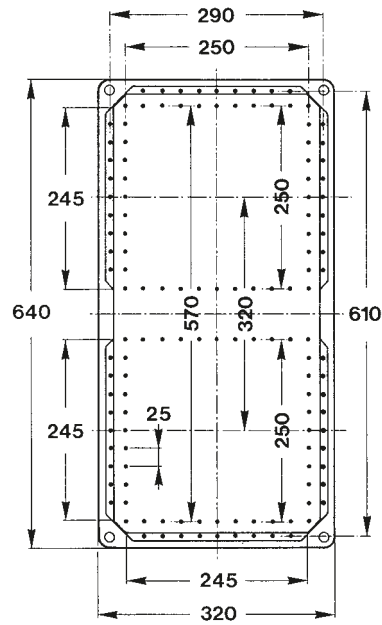

VMS 33

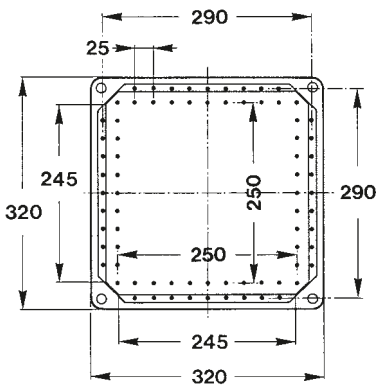

VMS 64

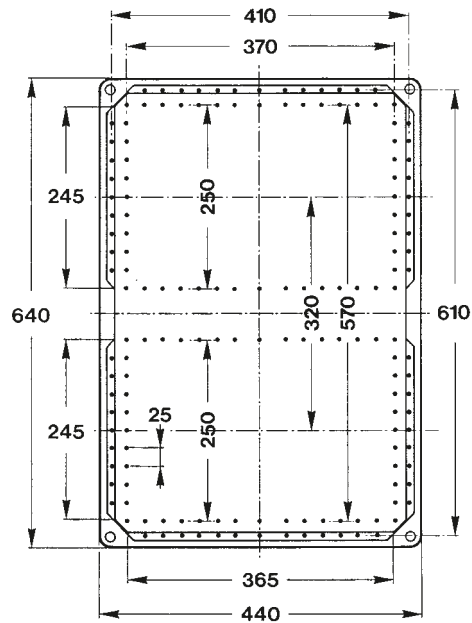

VMS 34

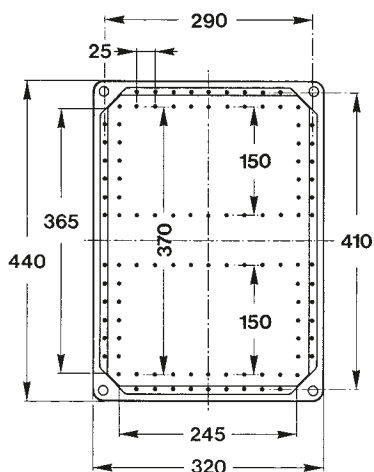

# General purpose enclosures technical details

## VMS – Dimensions

### Bases

#### Openings in the base side walls

##### Side 220

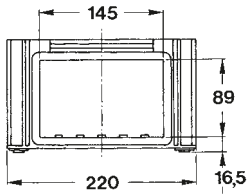

##### Side 320

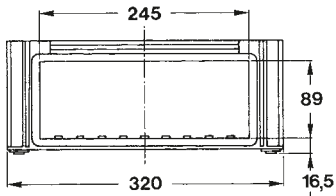

##### Side 440

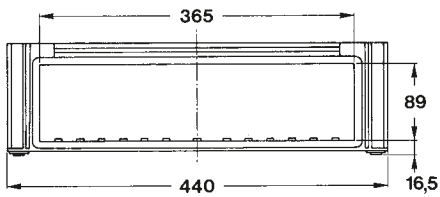

##### Side 640

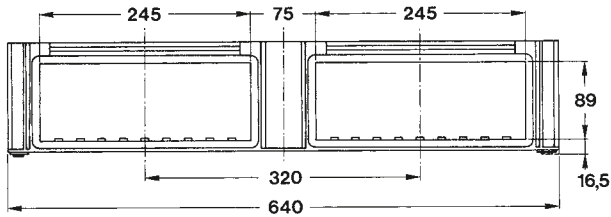

#### Built-in heights

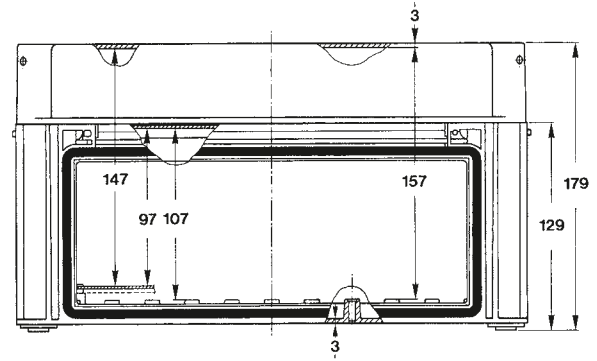

#### Pivoting covers

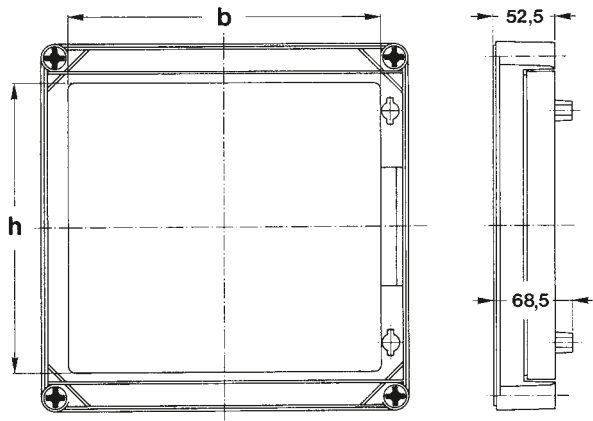

Type	Dimensions	b	h
VMS 33	320×320mm	260	241
VMS 43	440×320mm	260	361

# General purpose enclosures technical details

## VMS – Dimensions

### Bases

#### Cable end plates and universal cable stress releases

##### Side 320

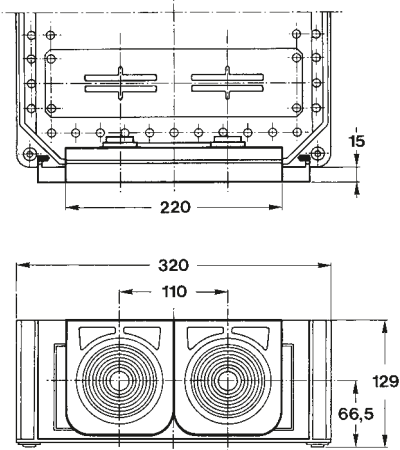

##### Side 440

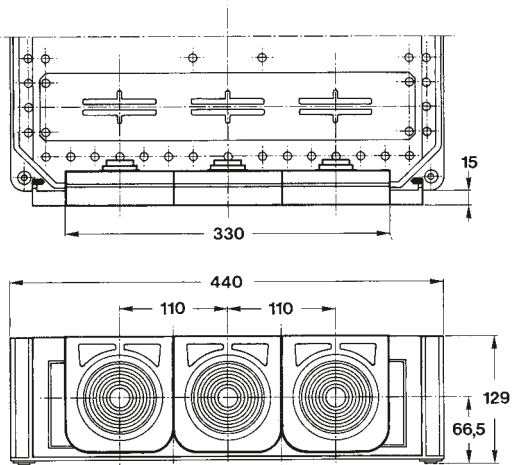

##### Side view

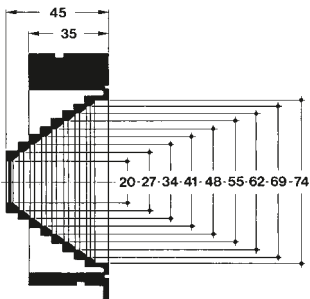

#### Mounting brackets

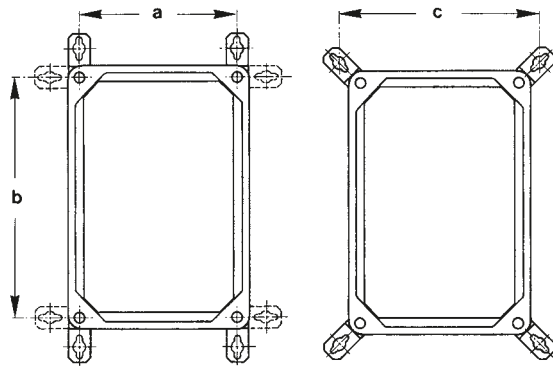

Type	Dimensions	a	b	c
VMS 32	320×220 mm	193	293	254
VMS 33	320×320 mm	293	293	354
VMS 43	440×320 mm	293	413	354
VMS 63	640×320 mm	293	613	354
VMS 64	640×440 mm	413	613	474

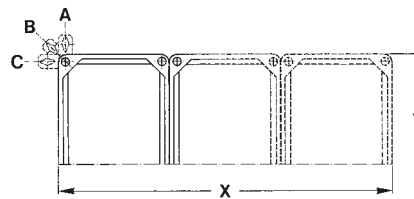

Centre dimensions		
A	X - 27	Y + 40
B	X + 34	Y + 34
C	X + 40	Y - 27

---

## General purpose enclosures technical details

VMS – Dimensions

Busbar supports

630 A-1 250 A - parallel

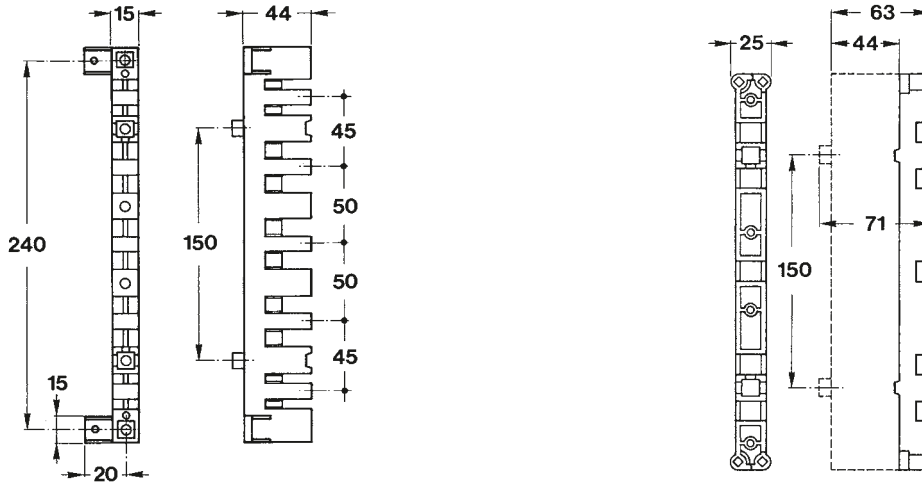





—  
04

**ARIA**



---

**ARIA**  
Index

<b>ARIA</b>	
Universal polyester enclosures	66
Universal polyester cabinets - Accessories	70
Dimensional	72
Power dissipation values	74

## General purpose enclosures

### ARIA - Universal polyester enclosures



ARIA

#### Applications

- Manufacturing
- Breweries
- Steelworks
- Public works
- Petro-chemical industry
- Road signage
- Temporary connections
- Telecoms
- Solar energy applications

**Standard: EN/IEC 61439-2, EN/IEC 60529, EN/IEC 62262, EN/IEC 62208**

#### Standards/Certification



- UL types 3, 3R, 3S, 4, 4X, 12 and 13  
Available upon request.



- CSA types 3, 3R, 3S, 4, 4X, 12 and 13  
Available upon request.

LR - Lloyd's Register of Shipping  
(IP66 versions with center lock)

#### Specifications

- Seven different types, from 315x215 to 1035x835 mm.
- Enclosures made from light gray polyester (RAL 7035), hot press molded, glass fiber-reinforced, dyed in the mass.
- The enclosure is equipped with 4 threaded rods and 4 nuts for securing a mounting plate or frame and is equipped as standard with a double-bit key lock.
- Maximum protection for the user and equipment thanks to its total insulation  $\square$  and IP65/66 protection rating in accordance with EN/IEC 62208 (IP54 for enclosures with inspection windows).
- IK08 protection rating against external mechanical impacts in accordance with EN/IEC 62208 (IK07 for cabinets with windows).
- Polyester boxes can resist temperatures of up to 70°C under continuous operation and peak temperatures of up to 130 °C.
- Self-extinguishing polyester, halogen-free.
- Insulation voltage  $U_i = 1000 \text{ V ac}$  and  $1500 \text{ V dc}$



## General purpose enclosures

### ARIA - Universal polyester enclosures



- |  |  |
|--|--|
| <ol style="list-style-type: none"> <li>1. Monobloc base</li> <li>2. Detachable door, left-hand or right-hand opening</li> <li>3. No water stagnation on the seal</li> <li>4. Mounting point in the door</li> <li>5. Front plate:             <ul style="list-style-type: none"> <li>- polyester RAL 7035</li> <li>- hinged</li> <li>- detachable</li> <li>- stand-alone</li> <li>- sealable</li> <li>- quick installation</li> </ul> </li> <li>3-point closure lock</li> </ol> | <ol style="list-style-type: none"> <li>6. Interchangeable cylinders</li> <li>7. Individual connection busbars</li> <li>8. Mounting frame:             <ul style="list-style-type: none"> <li>- removable</li> <li>- perforated</li> <li>- reinforced DIN rails</li> </ul> </li> <li>9. Integral hinges 180° pivoting door</li> <li>10. Mounting plate             <ul style="list-style-type: none"> <li>- metal</li> <li>- pertinax</li> <li>- perforated</li> </ul> </li> <li>11. Mounts directly onto the wall or via external mounting lugs made from stainless or synthetic material</li> </ol> |
|--|--|

## General purpose enclosures

### ARIA - Universal polyester enclosures

		☐	☐
<b>Type</b>		<b>ARIA 32</b>	<b>ARIA 43</b>
Individual front plates HxW x D		315x215x170	415 x 315 x 170
	Enclosure ☐ IP65 - IK08. With one or two double-bit, 3 mm locks two-point closure	<b>Type</b> - <b>Order code</b> 4TBA831035C0100	AR043P13 <sup>(1)</sup> 4TBA831035C0100
	Enclosure with inspection window ☐ IP54 - IK07 With one or two double-bit, 3 mm locks	<b>Type</b> - <b>Order code</b> 4TBA831128C0100	AR043T33 4TBA831128C0100
	Enclosure ☐ IP66 - IK08 With 1 double-bit, 3 mm center lock three-point closure mechanism	<b>Type</b> AR032P13 <sup>(1)</sup> <b>Order code</b> 4TBA831025C0100	AR043P33 4TBA831036C0100
	Enclosure with inspection window ☐ IP54 - IK07 with 1 double-bit, 3mm center lock	<b>Type</b> - <b>Order code</b> 4TBA831815C0100	AR043T23 4TBA831815C0100
	Enclosure ☐ IP66 - IK08 With 1 security lock handle	<b>Type</b> AR032T13 <b>Order code</b> 4TBA831307C0100	AR043H33 4TBA831034C0100
	Mounting plates Dimensions HxW	250 x 150	350 x 250
	Pertinax 5 mm	<b>Type</b> AR032I03 <b>Order code</b> 4TBA831027C0100	AR043I03 4TBA831038C0100
	2 mm Sendzimir galvanized steel panel	<b>Type</b> AR032M03 <b>Order code</b> 4TBA831026C0100	AR043M03 4TBA831037C0100
	1.5 mm perforated metal panel	<b>Type</b> AR032Q03 <b>Order code</b> 4TBA831332C0100	AR043Q03 4TBA831333C0100
	Mounting frame	<b>Type</b> AR032D03 <b>Order code</b> 4TBA831030C0100	AR043D03 4TBA831041C0100
	Rows	2	2
	Modules	12	24
	Full cover plates Solid	<b>Type</b> AR032C03 <b>Order code</b> 4TBA831028C0100	AR043C03 4TBA831039C0100
	With openings for DIN rail equipment	<b>Type</b> AR032S03 <b>Order code</b> 4TBA831029C0100	AR043S03 4TBA831040C0100
	With openings for individual modular front plates	<b>Type</b> - <b>Order code</b> 4TBA831790C0100	AR043E03 4TBA831790C0100
	Number of individual modular front plates possible	-	2
	Note: the ARIA 43 and 86 cabinets and ARIA 64 and 108 cabinets contain the same modular closure plates (Closed and with openings)		
	Individual front plates HxW	-	150 x 239
	IP20 individual modular protective plates (PVC) Solid	<b>Type</b> - <b>Order code</b> 4TBA831797C0100	AR043N03 4TBA831797C0100
	With openings for DIN rail equipment	<b>Type</b> - <b>Order code</b> 4TBA831796C0100	AR043R03 4TBA831796C0100
	Modules	-	12

(1) single-point closure  
Pack = 1

## General purpose enclosures



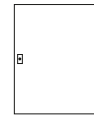

### ARIA - Universal polyester enclosures











ARIA 54	ARIA 64	ARIA 75	ARIA 86	ARIA 108
515x415x230	615x415x230	735x535x270	835x635x300	1035x835x300
AR054P23	AR064P23	AR075P23	AR086P23	AR108P23
4TBA831809C0100	4TBA831810C0100	4TBA831811C0100	4TBA831059C0100	4TBA831073C0100
AR054T23	AR064T23	AR075T23	-	-
4TBA831812C0100	4TBA831813C0100	4TBA831814C0100		
two-point closure	two-point closure	two-point closure		
AR054P33	AR064P33	AR075P33	AR086P33	AR108P33
4TBA831052C0100	4TBA831065C0100	4TBA831081C0100	4TBA831098C0100	4TBA831112C0100
AR054T33	AR064T33	AR075T33	AR086T33	AR108T33
4TBA831129C0100	4TBA831130C0100	4TBA831131C0100	4TBA831132C0100	4TBA831133C0100
AR054H33	AR064H33	AR075H33	AR086H33	AR108H33
4TBA831051C0100	4TBA831064C0100	4TBA831080C0100	4TBA831097C0100	4TBA831111C0100
450 x 350	550 x 350	650 x 450	750 x 550	950 x 750
AR054I03	AR064I03	AR075I03	AR086I03	AR108I03
4TBA831054C0100	4TBA831067C0100	4TBA831083C0100	4TBA831100C0100	4TBA831114C0100
AR054M03	AR064M03	AR075M03	AR086M03	AR108M03
4TBA831053C0100	4TBA831066C0100	4TBA831082C0100	4TBA831099C0100	4TBA831113C0100
AR054Q03	AR064Q03	AR075Q03	AR086Q03	AR108Q03
4TBA831334C0100	4TBA831335C0100	4TBA831336C0100	4TBA831337C0100	4TBA831338C0100
AR054D03	AR064D03	AR075D03	AR086D03	AR108D03
4TBA831057C0100	4TBA831070C0100	4TBA831086C0100	4TBA831103C0100	4TBA831117C0100
3	3	4	4	5
54	54	88	96	180
AR054C03	AR064C03	AR075C03	AR086C03	AR108C03
4TBA831055C0100	4TBA831068C0100	4TBA831084C0100	4TBA831101C0100	4TBA831115C0100
AR054S03	AR064S03	AR075S03	AR086S03	AR108S03
4TBA831056C0100	4TBA831069C0100	4TBA831085C0100	4TBA831102C0100	4TBA831116C0100
AR054E03	AR064E03	AR075E03	AR086E03	AR108E03
4TBA831791C0100	4TBA831792C0100	4TBA831793C0100	4TBA831794C0100	4TBA831795C0100
3	3	4	8	10
150 x 343	150 x 343	150 x 239	150 x 239	150 x 343
AR054N03	AR064N03	AR075N03	AR043N03	AR064N03
4TBA831799C0100	4TBA831801C0100	4TBA831803C0100	4TBA831797C0100	4TBA831801C0100
AR054R03	AR064R03	AR075R03	AR043R03	AR064R03
4TBA831798C0100	4TBA831800C0100	4TBA831802C0100	4TBA831796C0100	4TBA831800C0100
17	18	22	12	18

## General purpose enclosures











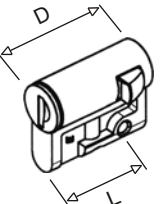

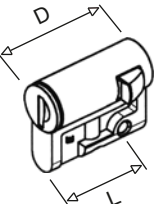
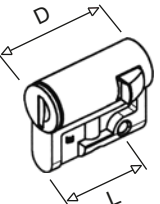

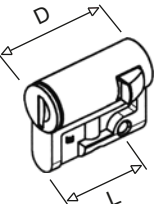

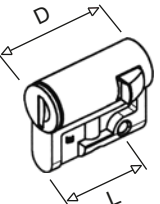
### ARIA - Universal polyester enclosures - Accessories

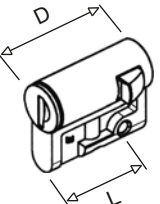
Product	Type	Order code	Pack
<b>Locks</b>			
With interchangeable cylinders (Supplied with 1 key)			
	3mm		
	 AR831008	4TBA831008C0100	1
	8mm		
	 AR831005	4TBA831005C0100	1
	8mm		
 AR831006	4TBA831006C0100	1	
11mm			
 AR831007	4TBA831007C0100	1	
Other locks: please contact us.			

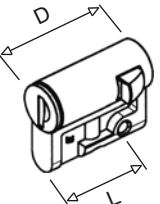
Product	Type	Order code	Pack
<b>Handles</b>			
Neutral handle (without lock)			
	AR831003	4TBA831003R0100	1
	With lock and 2 keys V2432E		
	AR831004	4TBA831004R0100	1
	With lock and 2 keys 1242E		
	AR831180	4TBA831180R0100	1
	With lock and 2 keys 405E		
	AR831152	4TBA831152C0100	1
	With lock and 2 keys 455E		
	AR831153	4TBA831153C0100	1
	Handle for lock, 45 mm semi-cylindrical profile		
	AR831821	4TBA831821C0100	1
	For replacing a double-bit lock or other locks for Aria 54, a mechanical adaptation of the door openings is required.		
Handle for lock with semi-cylindrical profile and locking by padlock			
	AR831822	4TBA831822C0100	1
	For replacing a double-bit lock or other locks for Aria 54, a mechanical adaptation of the door openings is required.		

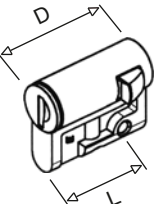
Product	Type	Order code	Pack
<b>Fixing lugs<sup>(1)</sup></b>			
	In 304 grade stainless steel Set of 4 pieces		
	ARACCB03	4TBA831000C0100	1
	Set of 4 polyamide pieces		
	ARACCB13	4TBA831001C0100	1
(1) not supplied as standard			

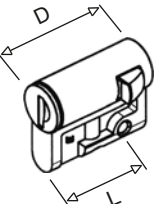
Product	Type	Order code	Pack
<b>Hinge supports for inner door</b>			
	Set of 2 pieces, for front plate		
	AR831010	4TBA831010C0100	1
A lower door may be installed together with a closed front plate.			

Product	Type	Order code	Pack
<b>Profile half cylinder locks</b>			
Standard: D = 40 mm - L = 30.5 mm			
	With 2 keys V2432-E		
	 PS832030	4TBP832030C0100	1
	Replacement keys for 832030		
	PS832741	4TBP832741R0100	2
	With 2 keys 1242-E		
	 PS832031	4TBP832031C0100	1
	With 2 keys 455-E		
	 PS832465	4TBP832465C0100	1
	With 2 keys 405-E		
	 PS832466	4TBP832466R0100	1
	With a replacement key, 8 mm		
	 PS832032	4TBP832032C0100	1
	With an 8 mm triangular key		
	 PS832033	4TBP832033C0100	1
	With an 11 mm triangular key		
	 PS832034	4TBP832034C0100	1
	With 3 mm double-bit key		
	 PS832029	4TBP832029C0100	1

Product	Type	Order code	Pack
<b>Vents</b>			
(IP44 if fitting in the double corner)			
	Set of 2 ventilation grilles. Bore hole Ø 34.9 mm		
	AR831009	4TBA831009C0100	1
See Sect. Cabinet ventilation for additional ventilation options.			

## General purpose enclosures

### ARIA - Universal polyester enclosures - Accessories

Product	Type	Order code	Pack
<b>Pedestal mounting assembly</b>			
	For ARIA 54/64		
	AR891608	4TBA891608C0100	1
	Fixing lugs in stainless steel included. Steel strips not included.		

Product	Type	Order code	Pack
<b>Connection busbars</b>			
6 x 10 mm <sup>2</sup> + 2 x 16 mm <sup>2</sup> clip onto 12 x 2 mm rail			
	Phase busbar - black		
	FORSTTL	4TBR610185C0200	4
	Ground busbar - green		
	FORSTTPE	4TBR610186C0200	4
	Neutral busbar - blue		
	FORSTTN	4TBR610187C0200	4

Product	Type	Order code	Pack
<b>Self-adhesive drip molding profile</b>			
	Length 415 mm for ARIA 54 and 64		
	AR831530	4TBA831530C0100	1
	May also be used for ARIA 32 and 43 after cutting out.		
	Length 835 mm for ARIA 108		
	AR831533	4TBA831533C0100	1
	May also be used for ARIA 75 and 86 after cutting out.		

Product	Type	Order code	Pack
<b>Module covers</b>			
	Sectionable by 1/2 module		
	12 modules		
	ZA3P5	4TBR610142C0200	5
	4 modules		
	FORSTBP500	4TBR610484C0200	500

Product	Type	Order code	Pack
<b>Label holders</b>			
	Adhesive		
	ZA10	4TBC851321C0100	1m

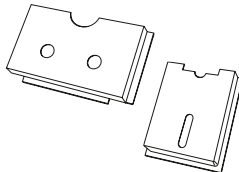
Product	Type	Order code	Pack
<b>Document pocket</b>			
	DIN A4 - L x H = 325 x 180 mm		
	AR811516	4TBC811516C0100	1
	DIN A5 - L x H = 155 x 225 mm		
	PS832000	4TBP832000C0100	1

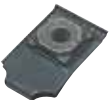
Product	Type	Order code	Pack
<b>Slide nuts</b>			
For perforated mounting plate			
	M4		
	AR831328	4TBA831328C0100	50
	M5		
	AR831329	4TBA831329C0100	50
	M6		
	AR831330	4TBA831330C0100	50

Product	Type	Order code	Pack
<b>Hinge pins</b>			
	Length 66 mm for ARIA 32		
	AR831653	4TBA831653C0100	20
	Length 100.5 mm for ARIA 43, 54 and 64		
	AR831652	4TBA831652C0100	20
	Length 131.5 mm for ARIA 75, 86 and 108		
	AR831953	4TBA831953C0100	10

# General purpose enclosures technical details

## ARIA – Dimensions

Cabinets

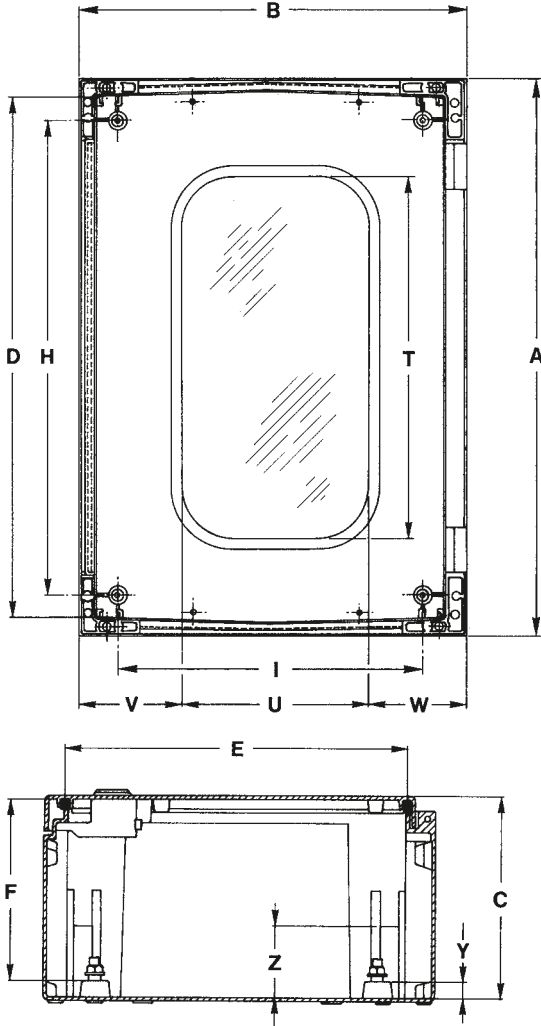

Wall mounting

Direct to the wall

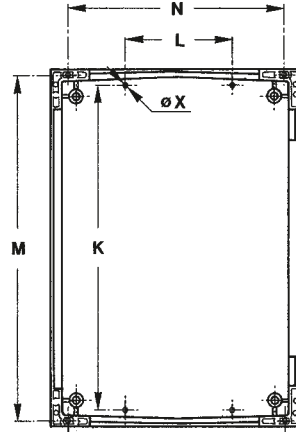

By fixing lugs in polyamide

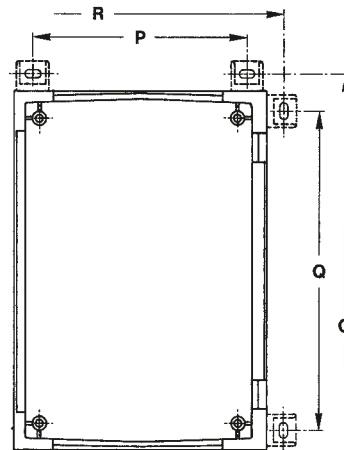

By fixing lugs in stainless steel

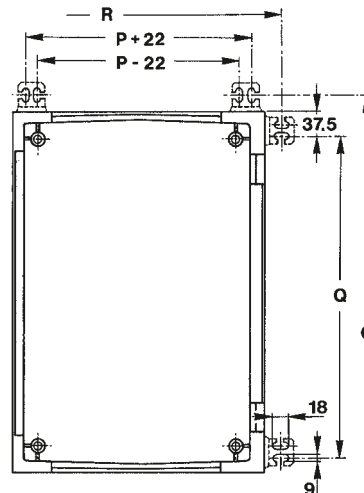

Dimensions

ARIA	32	43	54	64	75	86	108
A	315	415	515	615	735	835	1035
B	215	315	415	415	535	635	835
C	170	170	230	230	270	300	300
D	275	375	475	575	675	775	975
E	170	270	370	370	470	570	770
F	148	148	208	208	248	278	277
H	225	325	425	525	625	725	925
I	125	225	325	325	425	525	725
K	275	375	475	575	675	775	975
L	70	150	200	200	300	400	600
M	295	395	495	595	-	-	-
N	155	255	355	355	-	-	-
O	362	462	562	662	782	882	1082
P	162	262	362	362	482	582	782
Q	262	362	462	562	682	782	982
R	262	362	462	462	582	682	882
T	-	280	380	480	580	680	880
U	-	130	230	230	330	430	630
V	-	70	70	70	80	80	80
W	-	115	115	115	125	125	125
X	6	6	6	6	8	8	8
Y	14	14	15,5	15,5	15,5	15,5	15,5
Z	28	25	88	88	118	148	148



# General purpose enclosures technical details

## ARIA – Dimensions

### Mounting plates

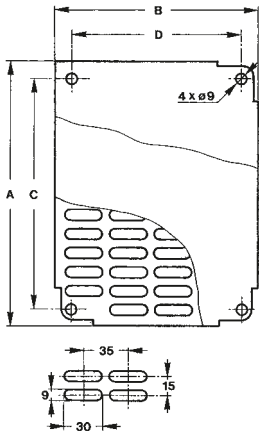

Dimensions				
ARIA	A	B	C	D
32	250	150	225	125
43	350	250	325	225
54	450	350	425	325
64	550	350	525	325
75	650	450	625	425
86	750	550	725	525
108	950	750	925	725

### Cover plates

#### Plain and with openings for DIN-rail equipment

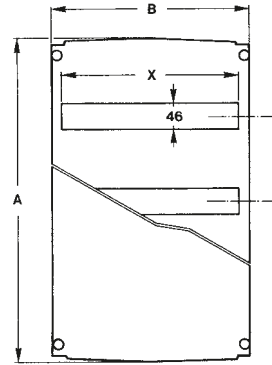

Dimensions				
ARIA	A	B	X	Y
32	2 rows 279	162	108	125
43	2 rows 379	262	216	150
54	3 rows 479	362	324	150
64	3 rows 579	362	324	150
75	4 rows 690	462	396	150
86	4 rows 790	562	2 x 216	150
108	5 rows 990	762	2 x 324	150

### Cover plates with cut-out for individual modular cover plates

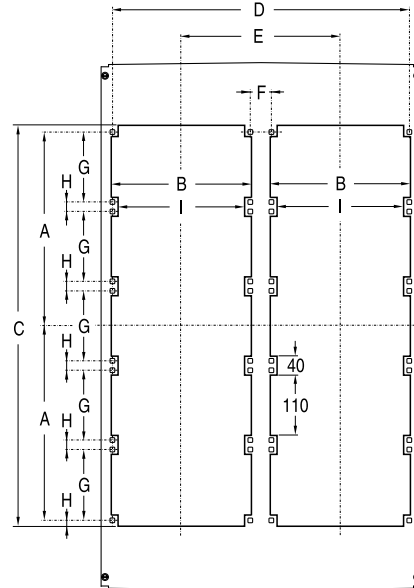
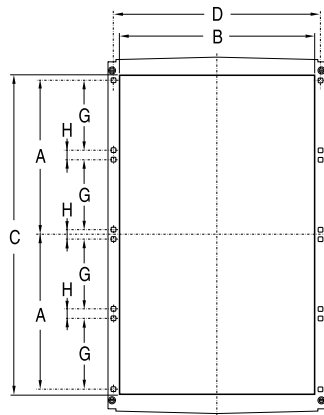
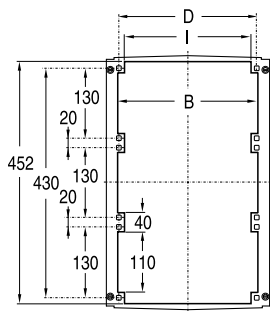

Dimensions										
Type	A	B	C	D	E	F	G	H	I	Mod.
ARIA 43	140	216	302	236	-	-	130	20	-	24
ARIA 54	-	308	-	303	-	-	-	-	283	51
ARIA 64	-	326	-	336	-	-	-	-	316	54
ARIA 75	290	400	602	428	-	-	130	20	-	88
ARIA 86	290	216	602	524	288	52	130	20	-	96
ARIA 108	365	326	752	732	396	60	130	20	316	180

### Individual modular cover plate

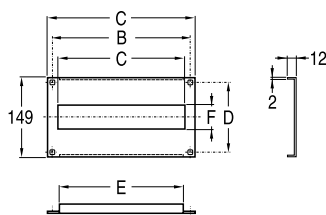

Dimensions						
Type	A	B	C	D	E	F
831796	255	236	216	130	210	46
831797	255	236	0	130	210	0
831798	322	303	306	130	280	46
831799	322	303	0	130	280	0
831800	355	336	324	130	312	46
831801	355	336	0	130	312	0
831802	455	428	396	130	396	46
831803	455	428	0	130	396	0





—  
05

**PolySafe**

---

**PolySafe**  
Index

<b>PolySafe</b>	
Multi-function polyester enclosures	78
Universal polyester enclosures	80
Modular framework for DIN-rail equipment - IP20	84
Modular functions and accessories	85
Accessories	86
Alu frame mounting applications	91
Dimensional	92
Power dissipation values	94

## General purpose enclosures

### PolySafe - Multi-function polyester enclosures



PolySafe

**Standard: EN/IEC 60529, EN/IEC 61439-2, EN/IEC 62208, EN/IEC 62262**

#### Specifications

- 16 standard dimensions (from 500x500 mm to 1250x1000 mm) with a depth of 320 mm.
- Enclosures supplied assembled (empty or equipped).
- IP55 and IP65 high protection ratings in accordance with EN/IEC 60529 and IK10 (20J) in accordance with EN/IEC 62262.
- Protection rating for enclosure with inspection window: IP54-IK07.
- Material: polyester reinforced with glass fiber, halogen-free, hot press molded and self-extinguishing.
- Color: RAL 7035 gray, dyed in the mass.
- Designed for wall, floor or pedestal mounting.
- Option of stacking vertically or horizontally widthwise or depthwise.
- Total insulation  $\square$ .
- 5-point door closure mechanism.
- Optional version on a DIN base.
- Insulation voltage  $U_i = 1000 \text{ V ac}$  and  $1500 \text{ V dc}$
- Product is easy to recycle: no molded metal parts.

#### Standards/Certification



- Single-door enclosure: type 3, 3R, 3S, 4, 4X, 12, 12K and 13
- Double-door enclosure: type 3R
- Coupled enclosures: type 3, 3R, 3S, 4, 4X, 12, 12K and 13 Available upon request.

LR - Lloyd's Register of Shipping

#### Conditions for use

Polyester boxes can withstand temperatures between  $-25^{\circ}\text{C}$  et  $+70^{\circ}\text{C}$  under continuous operation and peak temperatures of up to  $130^{\circ}\text{C}$ .



---

## General purpose enclosures

PolySafe - Multi-function polyester enclosures



### Applications

- Commercial  
Leisure (marketplaces, camps, leisure ports, attraction parks, etc.), gas stations, carwashes, laundromats, industrial laundries, construction site enclosures, etc.
- Industrial  
Ship building, mining, automobile industry, paper industry, sugar refinery, food industry, distilleries, petrochemical industry, heavy industry, processing, surveillance systems, etc.
- Utilities  
Water treatment sites, gray water processing, telecommunications, traffic signaling, traffic management, public transport, energy distribution (electricity, gas, water), cable television, public lighting, railways, etc.



## General purpose enclosures

### PolySafe - Universal polyester enclosures



#### Depth = 320 mm

PS 220

#### Factory-assembled enclosures

Equipped with AISI 304 stainless steel fixing lugs and handle (lock not supplied)

Dimensions (HxL)	500 x 500
Enclosure with <b>IP55</b> solid door	<b>Type</b> PS833194 <b>Order code</b> 4TBP833194N0100
Enclosure with <b>IP65</b> solid door	<b>Type</b> PS220P63 <b>Order code</b> 4TBP833000C0100
Enclosure with <b>IP54</b> inspection window (polycarbonate inspection window)	<b>Type</b> PS220T43 <b>Order code</b> 4TBP833850C0100
Weight (kg)	16



#### IP65 depth extension kit

For increasing the standard depth of the enclosure from 320 mm to 640 mm. The kit comprises 2 side panels, 1 upper panel, 1 lower panel, 2 rear open panels (frames).

<b>Type</b>	PS220D63
<b>Order code</b>	4TBP833584C0100



#### Hoods

Necessary if efficient (IP44) ventilation is required, includes drilled holes in the upper panel and the use of fins.

<b>Type</b>	PS200R03
<b>Order code</b>	4TBP833566C0100

The basic enclosure is IP65 rated, the hood is optional. If larger widths or depths are required, please contact us.

#### Base for ground installation

The enclosure and base are anchored together into the ground. H = 65 mm

<b>Type</b>	PS200Z03
<b>Order code</b>	4TBP833574C0100



#### Adaptor frame for DIN-base mounting

The enclosure and adaptation kit are anchored together onto the DIN socket (polyester)

<b>Type</b>	-
<b>Order code</b>	-
<b>DIN base</b>	<b>Type</b> EH3SEXEI
Polyester - RAL 7035	<b>Order code</b> 4TBE843204R0100

#### Mounting plates

Dimensions (H - 110 mm x L - 110 mm)

2 mm Sendzimir galvanized sheet metal	<b>Type</b> PS220M03 <b>Order code</b> 4TBP833500C0100
Pertinax 5 mm	<b>Type</b> PS220I03 <b>Order code</b> 4TBP833508C0100
Pertinax 10mm	<b>Type</b> - <b>Order code</b> -





## General purpose enclosures

PolySafe - Universal polyester enclosures

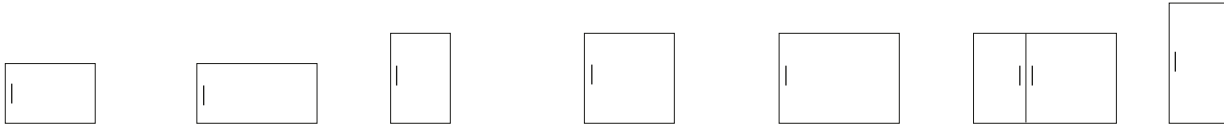

PS 230	PS 240	PS 320	PS 330	PS 340	PS 352	PS 420
500 x 750	500 x 1000	750 x 500	750 x 750	750 x 1000	750 x 1250	1000 x 500
PS833195	-	PS833196	PS833197	PS833198	PS833235 (*)	PS833199
4TBP833195N0100		4TBP833196N0100	4TBP833197N0100	4TBP833198N0100	4TBP833235N0100	4TBP833199N0100
PS230P63	PS240P63	PS320P63	PS330P63	PS340P63	PS352P63	PS420P63
4TBP833004C0100	4TBP833193C0100	4TBP833008C0100	4TBP833012C0100	4TBP833016C0100	4TBP833020C0100	4TBP833024C0100
PS230T43	-	PS320T43	PS330T43	PS340T43	PS352T43	PS420T43
4TBP833851C0100		4TBP833852C0100	4TBP833853C0100	4TBP833854C0100	4TBP833855C0100	4TBP833856C0100
19	25	20	25	30	38	25
PS230D63	-	PS320D63	PS330D63	PS340D63	PS350D63	PS420D63
4TBP833585C0100		4TBP833586C0100	4TBP833587C0100	4TBP833588C0100	4TBP833589C0100	4TBP833590C0100
PS300R03	PS400R03	PS200R03	PS300R03	PS400R03	PS500R03	PS200R03
4TBP833568C0100	4TBP833570C0100	4TBP833566C0100	4TBP833568C0100	4TBP833570C0100	4TBP833572C0100	4TBP833566C0100
PS300Z03	PS400Z03	PS200Z03	PS300Z03	PS400Z03	PS500Z03	PS200Z03
4TBP833575C0100	4TBP833576C0100	4TBP833574C0100	4TBP833575C0100	4TBP833576C0100	4TBP833577C0100	4TBP833574C0100
PS300A03	PS400A03	-	PS300A03	PS400A03	-	-
4TBP833582C0100	4TBP833583C0100		4TBP833582C0100	4TBP833583C0100		
EH3SE1EI	EH3SE2EI	EH3SEXEI	EH3SE1EI	EH3SE2EI	-	EH3SEXEI
4TBE843206R0100	4TBE843207R0100	4TBE843204R0100	4TBE843206R0100	4TBE843207R0100		4TBE843204R0100
PS320M03	PS420M03	PS320M03	PS330M03	PS430M03	PS530M03	PS420M03
4TBP833501C0100	4TBP833503C0100	4TBP833501C0100	4TBP833502C0100	4TBP833504C0100	4TBP833506C0100	4TBP833503C0100
PS320I03	PS420I03	PS320I03	PS330I03	PS430I03	PS530I03	PS420I03
4TBP833509C0100	4TBP833511C0100	4TBP833509C0100	4TBP833510C0100	4TBP833512C0100	4TBP833514C0100	4TBP833511C0100
-	-	-	-	-	PS833385	-
					4TBP833385N0100	

(\*) on request

## General purpose enclosures

### PolySafe - Universal polyester enclosures



Depth = 320 mm		PS 430
<b>Factory-assembled enclosures</b>		
Equipped with AISI 304 stainless steel fixing lugs and handle (lock not supplied)		
Dimensions (HxL)	1000 x 750	
Enclosure with <b>IP55</b> solid door	<b>Type</b>	PS833204
	<b>Order code</b>	4TBP833204N0100
Enclosure with <b>IP65</b> solid door	<b>Type</b>	PS430P63
	<b>Order code</b>	4TBP833028C0100
Enclosure with <b>IP54</b> inspection window (polycarbonate inspection window)	<b>Type</b>	PS430T43
	<b>Order code</b>	4TBP833857C0100
Weight (kg)	30	
<b>IP65 depth extension kit</b>		
For increasing the standard depth of the enclosure from 320 mm to 640 mm. The kit comprises 2 side panels, 1 upper panel, 1 lower panel, 2 rear open panels (frames).		<b>Type</b>
		PS430D63
	<b>Order code</b>	4TBP833591C0100
<b>Base for ground installation</b>		
The enclosure and base are anchored together into the ground. H = 65 mm		<b>Type</b>
		PS200Z03
	<b>Order code</b>	4TBP833574C0100
<b>Hoods</b>		
Necessary if efficient (IP44) ventilation is required, includes drilled holes in the upper panel and the use of fins.		<b>Type</b>
		PS300R03
The basic enclosure is IP65 rated, the hood is optional. If larger widths or depths are required, please contact us.		<b>Order code</b>
		4TBP833568C0100
<b>Base for ground installation</b>		
The enclosure and base are anchored together into the ground. H = 70 mm		<b>Type</b>
		PS300Z03
	<b>Order code</b>	4TBP833575C0100
<b>Adaptor frame for DIN-base mounting</b>		
The enclosure and adaptation kit are anchored together onto the DIN socket (polyester)		<b>Type</b>
		PS300A03
	<b>Order code</b>	4TBP833582C0100
<b>DIN base</b>		
Polyester - RAL 7035		<b>Type</b>
		EH3SE1EI
	<b>Order code</b>	4TBE843206R0100
<b>Mounting plates</b>		
Dimensions (H - 110 mm x L - 110 mm)		<b>Type</b>
2 mm Sendzimir galvanized sheet metal		PS430M03
	<b>Order code</b>	4TBP833504C0100
Pertinax 5 mm	<b>Type</b>	PS430I03
	<b>Order code</b>	4TBP833512C0100
Pertinax 10 mm	<b>Type</b>	-
	<b>Order code</b>	-

## General purpose enclosures

### PolySafe - Universal polyester enclosures

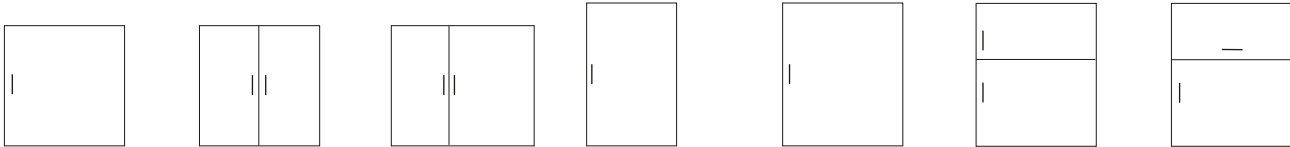

PS 440	PS 442	PS 452	PS 530	PS 540 <sup>(1)</sup>	PS 542	PS 546
1000 x 1000	1000 x 1000	1000 x 1250	1250 x 750	1250 x 1000	1250 x 1000	1250 x 1000
PS833212	PS442P53 (*)	PS452P53 (*)	PS833233	PS833889	PS542P53 (*)	-
4TBP833212N0100	4TBP833241C0100	4TBP833242C0100	4TBP833233N0100	4TBP833889C0100	4TBP833243C0100	-
PS440P63	PS442P63	PS452P63	PS530P63	-	PS542P63	PS833056
4TBP833032C0100	4TBP833036C0100	4TBP833040C0100	4TBP833044C0100	-	4TBP833052C0100	4TBP833056C0100
-	PS442T43	PS452T43	PS530T43	-	PS542T43	-
-	4TBP833858C0100	4TBP833859C0100	4TBP833860C0100	-	4TBP833861C0100	-
36	39	41	37	42	45	45
PS440D63	PS440D63	PS833593	PS530D63	-	PS540D63	PS540D63
4TBP833592C0100	4TBP833592C0100	4TBP833593C0100	4TBP833594C0100	-	4TBP833595C0100	4TBP833595C0100
PS300Z03	PS400Z03	PS200Z03	PS300Z03	PS400Z03	PS500Z03	PS200Z03
4TBP833575C0100	4TBP833576C0100	4TBP833574C0100	4TBP833575C0100	4TBP833576C0100	4TBP833577C0100	4TBP833574C0100
PS400R03	PS400R03	PS500R03	PS300R03	PS400R03	PS400R03	PS400R03
4TBP833570C0100	4TBP833570C0100	4TBP833572C0100	4TBP833568C0100	4TBP833570C0100	4TBP833570C0100	4TBP833570C0100
PS400Z03	PS400Z03	PS500Z03	PS300Z03	PS400Z03	PS400Z03	PS400Z03
4TBP833576C0100	4TBP833576C0100	4TBP833577C0100	4TBP833575C0100	4TBP833576C0100	4TBP833576C0100	4TBP833576C0100
PS400A03	PS400A03	-	PS300A03	PS400A03	PS400A03	PS400A03
4TBP833583C0100	4TBP833583C0100	-	4TBP833582C0100	4TBP833583C0100	4TBP833583C0100	4TBP833583C0100
EH3SE2EI	EH3SE2EI	-	EH3SE1EI	EH3SE2EI	EH3SE2EI	EH3SE2EI
4TBE843207R0100	4TBE843207R0100	-	4TBE843206R0100	4TBE843207R0100	4TBE843207R0100	4TBE843207R0100
PS440M03	PS440M03	PS540M03	PS530M03	PS540M03	PS540M03	PS540M03
4TBP833505C0100	4TBP833505C0100	4TBP833507C0100	4TBP833506C0100	4TBP833507C0100	4TBP833507C0100	4TBP833507C0100
PS440I03	PS440I03	PS540I03	PS530I03	PS540I03	PS540I03	PS540I03
4TBP833513C0100	4TBP833513C0100	4TBP833515C0100	4TBP833514C0100	4TBP833515C0100	4TBP833515C0100	4TBP833515C0100
PS833386	PS833386	PS833387	PS833385	PS833387	PS833387	PS833387
4TBP833386C0100	4TBP833386C0100	4TBP833387C0100	4TBP833385N0100	4TBP833387C0100	4TBP833387C0100	4TBP833387C0100

(1) PolySafe PS540 only available in IP54 execution  
(\*) on request

## General purpose enclosures

PolySafe - Modular framework for DIN-rail equipment - IP20



Supplied as a self-assembly kit

Kit contains:

- 2 x support for left-hand vertical profile
- 2 x support for right-hand vertical profile
- 2 x vertical profiles
- 2 x IP20 insulated vertical profiles
- 2 x IP20 insulated horizontal profiles
- assembly accessories

Product	Type	Order code
---------	------	------------

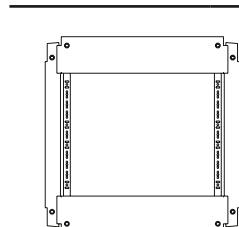

40 mod. - HxL = 500x500	PS220F03	4TBP833264C0100
68 mod. - HxL = 500x750	PS230F03	4TBP833265C0100

Product	Type	Order code
---------	------	------------

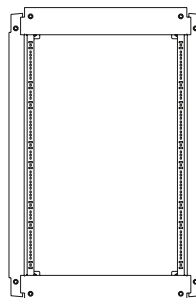

80 mod. - HxL = 750x500	PS320F03	4TBP833266C0100
136 mod. - HxL = 750x750	PS330F03	4TBP833267C0100

Product	Type	Order code
---------	------	------------

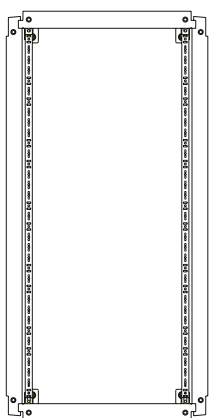

120 mod. - HxL = 1000x500	PS420F03	4TBP833268C0100
204 mod. - HxL = 1000x750	PS430F03	4TBP833269C0100

Product	Type	Order code
---------	------	------------

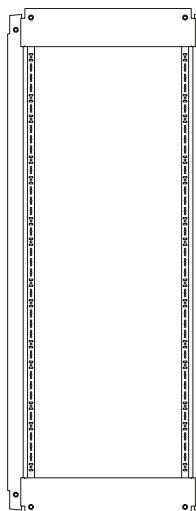

238 mod. - HxL = 1250x750	PS530F03	4TBP833270C0100
---------------------------	----------	-----------------

## General purpose enclosures

### PolySafe - Modular functions and accessories

#### Modular functions for DIN equipment (to be mounted on the modular frame)



Contents:  
- DIN rail  
- cover plate with rectangular opening  
- mounting accessories

##### Center line distance 150mm

Height	Width	500mm	750mm
150mm			
	Modules (1 mod. = 18mm)	20	34
	Type	PS833272	PS833278
	Order code	4TBP833272C0100	4TBP833278C0100

#### Modular functions for terminals or other equipment (to be mounted on the modular frame)



Contents:  
- DIN rail  
- solid cover plate  
- mounting accessories

##### Center line distance 150mm

Height	Width	500mm	750mm
150mm			
	Type	PS833271	PS833277
	Order code	4TBP833271C0100	4TBP833277C0100
300mm			
	Type	PS833274	PS833280
	Order code	4TBP833274C0100	4TBP833280C0100

#### Accessories (to be mounted on the modular frame)







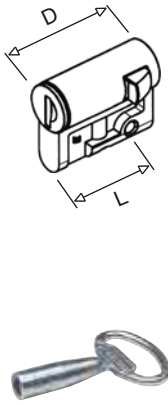

Product	Type	Order code	Pack
<b>Metal mounting plates</b>			
	HxL = 150x500mm	PS833275	4TBP833275C0100
	HxL = 150x750mm	PS833281	4TBP833281C0100
	HxL = 300x500mm	PS833276	4TBP833276C0100
	HxL = 300x750mm	PS833282	4TBP833282C0100

#### Accessories (to be mounted on the modular frame)

Product	Type	Order code	Pack	
<b>Depth extension studs for metal mounting plates with n. 2 M5x10 screws - (1 set = 2 pieces)</b>				
	Length 20-35-50mm	VMW2050	4TBW828059C0100	
	Length 25-40-55mm	VMW2555	4TBW828060C0100	
	Length 30-45-60mm	VMW3060	4TBW828061C0100	
	Length 65-80-95mm	VMW6595	4TBW828062C0100	
	Length 70-85-100mm	VMW70100	4TBW828063C0100	
	Length 75-90-105mm	VMW75105	4TBW828064C0100	
	Length 110-125-140mm	VMW110	4TBW828031C0100	

## General purpose enclosures

### PolySafe - Accessories

Product	Type	Order code	Pack
<b>Profile half cylinder locks</b>			
Standard: D = 40 mm - L = 30.5 mm			
	With 2 keys V2432-E		
	 PS832030	4TBP832030C0100	1
	Replacement keys for PS832030		
	PS832741	4TBP832741R0100	2
	With 2 keys 1242-E		
	 PS832031	4TBP832031C0100	1
	With 2 keys 455-E		
	 PS832465	4TBP832465C0100	1
	With 2 keys 405-E		
	 PS832466	4TBP832466R0100	1
	With 1 square key, 8 mm		
	 PS832032	4TBP832032C0100	1
	With an 8 mm triangular key		
	 PS832033	4TBP832033C0100	1
	With an 11 mm triangular key		
 PS832034	4TBP832034C0100	1	
With 1 double-bit key, 3 mm			
 PS832029	4TBP832029C0100	1	

#### Handle



For lock with half cylinder profile (as replacement)

PS833629 4TBP833629C0100 1

#### Padlocking handle



For padlock (Ø10mm max.)

PS833630 4TBP833630R0100 1

#### Depth adjustment kit

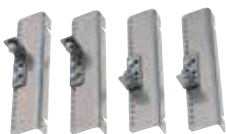

Set of 4 brackets for adjusting the depth of the mounting plates (12.5 mm increments)

PS833528 4TBP833528C0100 1

Product	Type	Order code	Pack
<b>Door stop/Canopy stop</b>			
Opening angle of 100° of the door or canopy (for >750-wide enclosures)			
	Left turning		
	PS833649	4TBP833649C0100	1
	Right turning		
	PS833650	4TBP833650C0100	1

#### Wall mounting supports for standard cabinets



Kit comprising 4 fixing lugs that clip into the rear of the enclosure. In Type 304 grade stainless steel. (replacement)

PS833651 4TBP833651C0100 1

#### Wall fixing lugs for enclosures equipped with a hood.



Kit comprising 4 fixing lugs that clip into the rear of the enclosure.

PS833624 4TBP833624C0100 1

#### Rainhood



Rainhoods for enclosure combinations. Standard rainhoods in the enclosure selection tables.

#### For enclosures dimensions (WxD)

1500x320mm	PS833656	4TBP833656C0100	1
1750x320mm	PS833657	4TBP833657C0100	1
2000x320mm	PS833658	4TBP833658C0100	1
2250x320mm	PS833659	4TBP833659C0100	1
2500x320mm	PS833660	4TBP833660C0100	1
3000x320mm	PS833661	4TBP833661C0100	1
500x640mm	PS833693	4TBP833693C0100	1
750x640mm	PS833692	4TBP833692C0100	1
1000x640mm	PS833783	4TBP833783C0100	1
1250x640mm	PS833784	4TBP833784C0100	1
1750x640mm	PS833743	4TBP833743C0100	1
2000x640mm	PS833691	4TBP833691C0100	1
2500x640mm	PS833764	4TBP833764C0100	1

# General purpose enclosures

## PolySafe - Accessories

Product	Type	Order code	Pack
---------	------	------------	------

### Pole mounting



Width = 500 mm	PS833625	4TBP833625C0100	1
Width = 750 mm	PS833626	4TBP833626C0100	1

By C profiles, at the rear of the enclosure and affixed to the lugs. Metal sheet is used for securing to the pedestal. Securing clamps are attached to the profiles to ensure that the metal sheet is held fast.



### IP65/IP54 coupling kit

H/B	G	J	Depth 320 mm	
500	330	6	PS833608	4TBP833608R0100 1
750	580	8	PS833610	4TBP833610R0100 1
1000	830	12	PS833612	4TBP833612R0100 1
1250	1080	14	PS833614	4TBP833614R0100 1

The kit contains the neoprene seal and the securing screws.

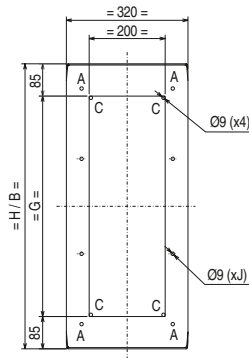

### Corner profile

To fill up the corner between two coupled enclosures

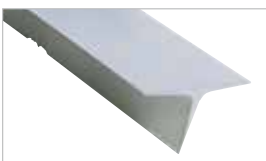

Length = 308mm	PS833653	4TBP833653R0100	1
----------------	----------	-----------------	---

Use 2 profiles when coupling n.4 enclosures

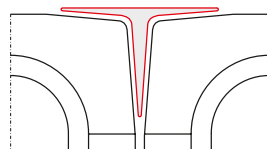

Product	Type	Order code	Pack
---------	------	------------	------

### IP20 inner door

HxW	Type	Order code	Pack
500x500 mm	PS833556	4TBP833556C0100	1
500x750 mm	PS833557	4TBP833557C0100	2
750x500 mm	PS833558	4TBP833558C0100	1
750x750 mm	PS833559	4TBP833559C0100	1
1000x500 mm	PS833561	4TBP833561C0100	1
1000x750 mm	PS833562	4TBP833562C0100	1

Frame and door with two double-bit closures. For control and automation applications.



### Solid front plates for 19"/ETSI frame

For filling remaining empty spaces			
For cabinets H x W = 500 x 750 Front plate height = 32 mm			
PS833684	4TBP833684C0100	1	
For cabinets H x W = 750 x 750 Front plate height = 15mm			
PS833685	4TBP833685C0100	1	
For cabinets H x W = 1250 x 750 Front plate height = 28mm			
PS833686	4TBP833686C0100	1	

Metal: RAL 7035 epoxy coating  
Note: not required for H x W = 1000x750 cabinets

## General purpose enclosures

### PolySafe - Accessories

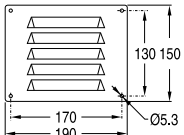
Product	Type	Order code	Pack
<b>Ventilation grille</b> 			
	PS832019	4TBP832019C0100	1
Adaptable to the ventilation opening. Kit comprises 2 grilles and 4 nylon screws.			
			

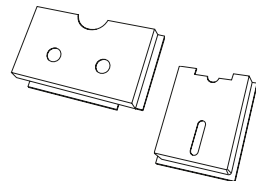
Product	Type	Order code	Pack
<b>Document pocket</b> 			
	DIN A4 - BxL = 325x180mm		
	AR811516	4TBC811516C0100	1
	DIN A5 - BxL= 155x225mm		
	PS832000	4TBP832000C0100	1

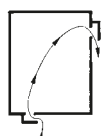
Product	Type	Order code	Pack
<b>Air vents IP44</b> 			
	Set of 2 polyamide pieces RAL 7035		
	PS833677	4TBP833677C0100	1
2 fins must be provided per enclosure in order to provide efficient ventilation and to prevent the formation of condensation. Supplied with a template and fixings. It is recommended to install the fins in the upper and lower sections of the enclosure.			
			

Product	Type	Order code	Pack
<b>Screws</b> 			
	Mounting plate installation kit (8 nuts and bolts).		
	PS833790	4TBP833790C0100	1 set
7.2 x 22 + M8 x 19 assembly screws for assembling the mounting plate and side panel with the lower panel/hood.			
	PS833687	4TBP833687C0100	100
7.2 x 22 securing screw for rear panel			
	PS833688	4TBP833688C0100	100



## General purpose enclosures

### PolySafe - Accessories

Product	Type	Order code	Pack
---------	------	------------	------

#### Nut made from insulating material

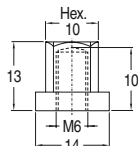

RAL 7035			
KIM601225	4TBC601225C0100	100	

#### Screws

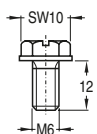

M6 flange screw			
ACC811483	4TBC811483C0100	100	

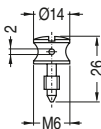

PVC M6 screw for cover plate (sealable)			
ACC811451	4TBC811451R0100	100	

#### Metal nut

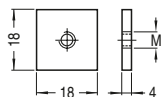

M6			
ACC811435	4TBC811435C0100	100	

M4			
ACC811438	4TBC811438C0100	100	

M6			
ACC811446	4TBC811446C0100	100	

M8			
ACC811447	4TBC811447C0100	100	

# General purpose enclosures

## PolySafe - Accessories

Product	Type	Order code	Pack
---------	------	------------	------

### Brackets

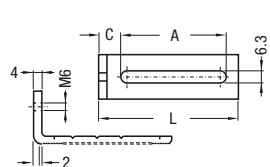

L = 40 - A = 24 - C = 9,5	ACC811478	4TBC811478R0100	100
L = 80 - A = 64 - C = 9,5	ACC811479	4TBC811479R0100	100

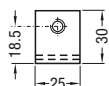

L = 120 - A = 64 - C = 49,5 - E = 41.5	ACC811480	4TBC811480C0100	100
--	-----------	-----------------	-----

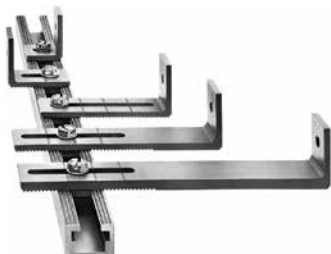
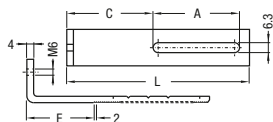

Product	Type	Order code	Pack
---------	------	------------	------

### Spacers

#### Type 1 - M4-M6



L = 15	ACC811336	4TBC811336C0100	100
--------	-----------	-----------------	-----

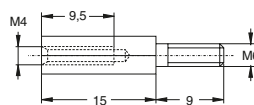

### Spacers

#### Type 2 - M6-M6

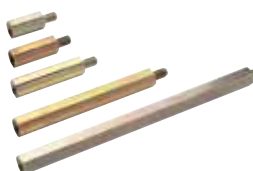

L = 15	ACC811337	4TBC811337C0100	100
L = 20	ACC811338	4TBC811338C0100	100
L = 25	ACC811454	4TBC811454R0100	100
L = 30	ACC811339	4TBC811339C0100	100
L = 35	ACC811455	4TBC811455R0100	100
L = 45	PS811456	4TBP811456R0100	100
L = 55	ACC811457	4TBC811457R0100	100
L = 65	ACC811458	4TBC811458R0100	100
L = 70	ACC811340	4TBC811340C0100	100
L = 80	ACC811460	4TBC811460R0100	100
L = 100	ACC811461	4TBC811461R0100	100
L = 120	ACC811341	4TBC811341C0100	100

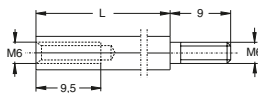

### Spacers

#### Type 3 - M6-M6



L = 60	ACC811342	4TBC811342C0100	100
L = 30	ACC811343	4TBC811343C0100	100

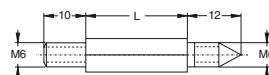

# General purpose enclosures technical details

## PolySafe – Alu frame mounting applications

Alu frame with progressive adjustment

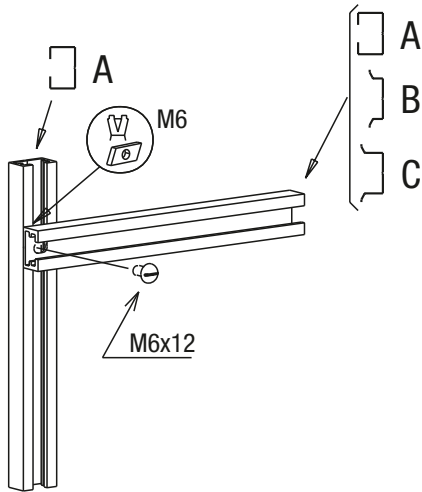

Installation of the cover plate

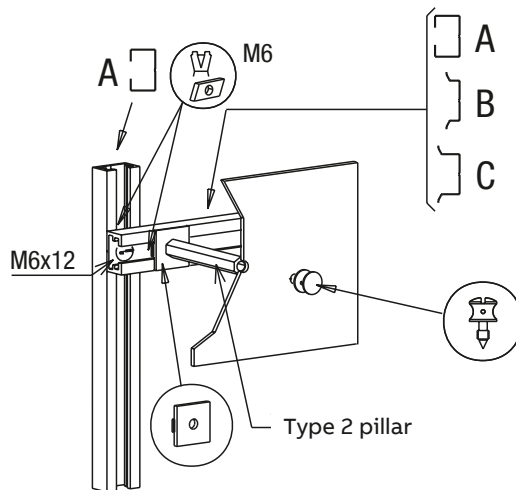
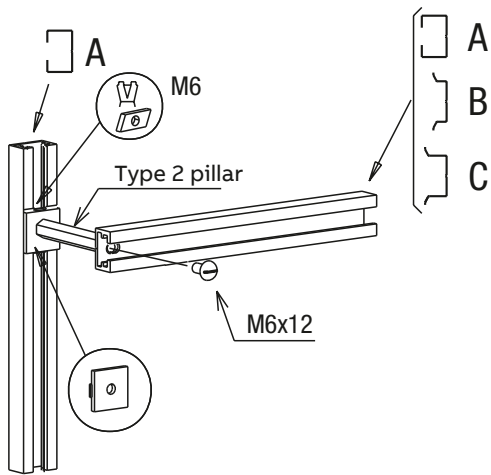
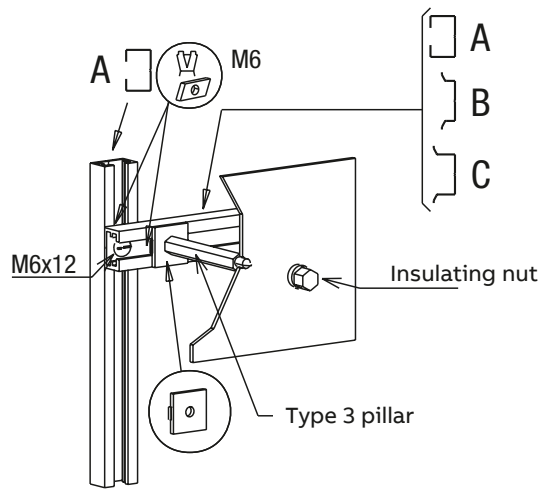

Note:  
Same installation technique as for the cover plate on the mounting plate.

Alu frame with adjustment in 12.5 mm increments

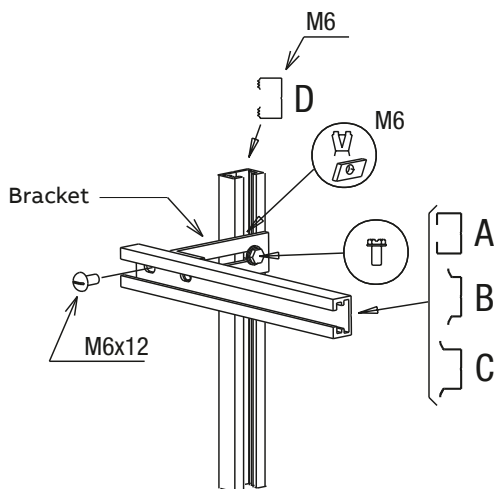

# General purpose enclosures technical details

## PolySafe – Dimensions

### Enclosures

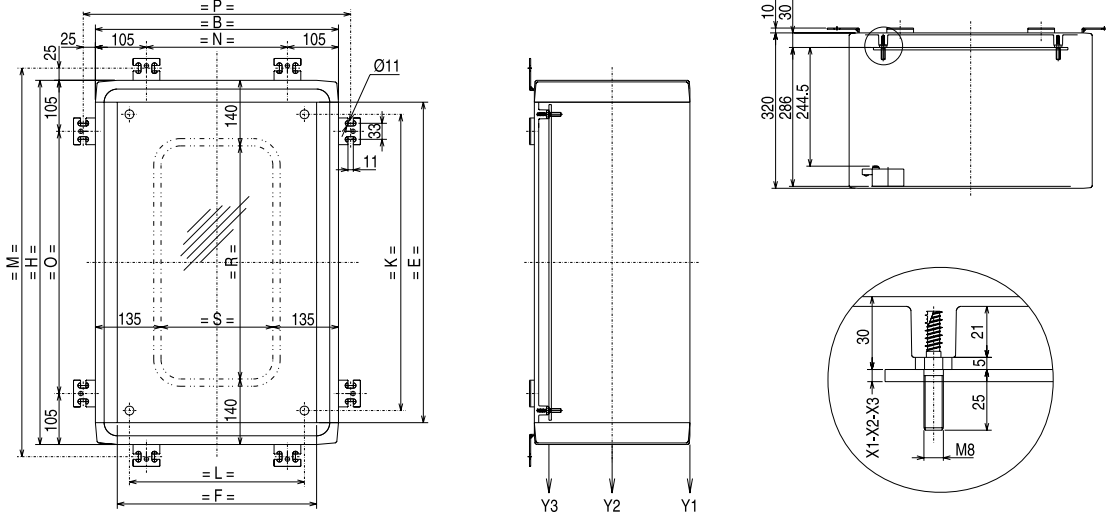

### Usable mounting space on the doors

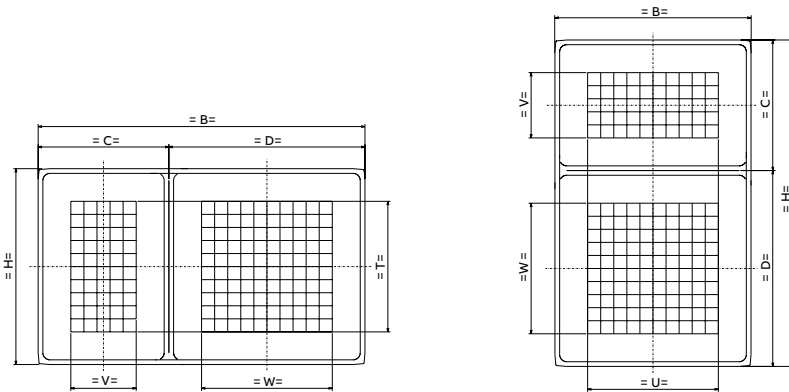

### Dimensions

Type	H	B	C	D	E	F	K	L	M	N	O	P	R	S	T	U	V	W	X1	X2	X3	Y1	Y2	Y3
220	500	500			410	410	360	360	550	290	290	550	220	230	250	250			5	2	-	8	80	110
230	500	750			410	660	360	610	550	540	290	800	220	480	250	500			5	2	-	8	80	110
320	750	500			660	410	610	360	800	290	540	550	470	230	500	250			5	2	-	8	80	110
330	750	750			660	660	610	610	800	540	540	800	470	480	500	500			5	2	-	8	80	110
340	750	1.000			660	910	610	860	800	790	540	1.050	470	730	500	750			5	2	-	6	80	110
352	750	1.250	500	750	660		610	1.110	800	1.040	540	1.300			500	250	500		5	2	10	5	80	110
420	1.000	500			910	410	860	360	1.050	290	790	550	720	230	750	250			5	2	-	8	80	110
430	1.000	750			910	660	860	610	1.050	540	790	800	720	480	750	500			5	2	-	8	80	110
440	1.000	1.000			910	910	860	860	1.050	790	790	1.050	720	730	750	750			5	2	10	6	80	110
442	1.000	1.000	500	500	910		860	860	1.050	790	790	1.050			750	250	250		5	2	10	6	80	110
452	1.000	1.250	500	750	910		860	1.110	1.050	1.040	790	1.300			750	250	500		5	2	10	5	80	110
530	1.250	750			1.160	660	1.110	610	1.300	540	1.040	800	970	480	1.000	500			5	2	10	8	80	110
542	1.250	1.000	500	750	910		1.110	860	1.300	790	1.040	1.050			750	250	500		5	2	10	6	80	110
546	1.250	1.000	500	750	910		1.110	860	1.300	790	1.040	1.050			750	250	500		5	2	10	6	80	110

Enclosure external dimensions

Door dimensions

Enclosure let-through

Centres of the mounting plate

Centres for wall mounting

Window surface

Usable mounting space on the doors

Thickness of the mounting plate

Admissible charge in kg

X1 = pertinax 5mm  
 X2 = metal perforated 2mm  
 X3 = pertinax 10mm

**General purpose enclosures technical details**

PolySafe – Dimensions

Inner door

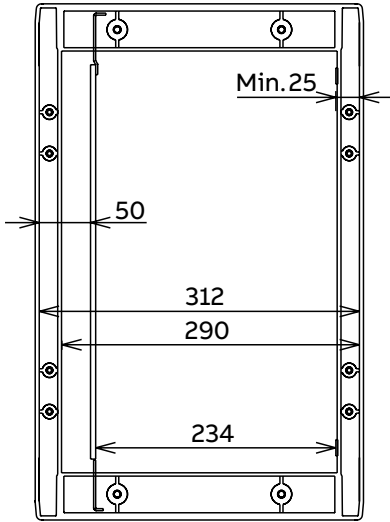

Adjustable mounting plate

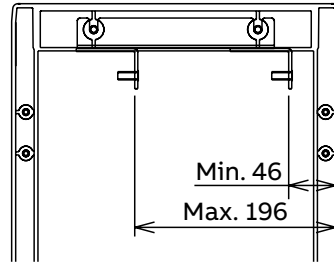

Adjustable mounting frame in steps of 12.5 mm

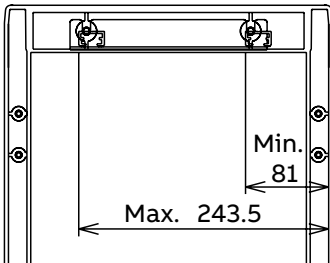

Continuously adjustable mounting frame

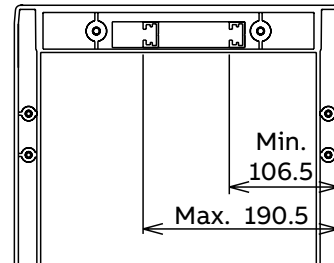



### General purpose enclosures technical details

### PolySafe - Power dissipation values

Dissipation Watt		Temperature rise [Kelvin]																							
		PS 220 500×500		PS 230 500×750		PS 320 750×500		PS 330 750×750		PS 340 750×1.000		PS 352 750×1.250		PS 420 1.000×500		PS 430 1.000×750		PS 440/442 1.000×1.000		PS 452 1.000×1.250		PS 530 1.250×750		PS 542/546 1.250×1.000	
Watt		Half	Top	Half	Top	Half	Top	Half	Top	Half	Top	Half	Top	Half	Top	Half	Top	Half	Top	Half	Top	Half	Top	Half	Top
10		5	6	4	5	4	5																		
20		9	10	7	8	7	9	5	7	5	5			6	8	5	6								
30		12	14	10	11	10	12																		
40		15	18	12	14	12	15	10	12	8	9	6	7	11	13	8	10	6	7	5	6	7	9	5	6
50		18	21	15	17	15	18																		
60		21	25	17	19	17	21	13	16	11	13	9	10	15	19	11	14	8	10	7	8	9	12	7	9
70		23	28	19	22	19	24																		
80		26	31	21	24	22	27	17	20	14	16	11	13	19	23	14	18	11	13	9	11	11	15	9	11
90		29	34	23	26	24	29																		
100		31	37	26	29	26	32	20	25	17	20	13	15	23	28	17	22	13	16	10	13	14	18	11	14
120		36	43	30	33	30	37	23	28	19	23			26	33	19	25	15	18						
140		41	49	33	38	34	42	26	32	22	26	17	20	30	37	22	28	17	21	14	16	18	24	14	18
160		46	54	37	42	38	47	29	36	24	29			33	41	25	31	18	23						
180		50	59	41	46	42	51	32	39	27	32	21	25	36	45	27	35	20	25	17	20	22	29	17	22
200				45	50	45	56	35	43	29	34			39	49	29	38	22	27						
220				48	54	49	60	38	46	31	37	25	29	42	53	32	41	24	29	20	24	26	35	20	26
240				52	58	52	65	41	50	33	40			46	57										
260								43	53	36	42	28	33	49	61	36	46	27	34	22	27	29	40	23	29
280								46	56	38	45			52	64										
300								48	59	40	48	32	37			41	52	31	38	25	30	33	44	24	33
350								55	67	45	54	36	42			46	59	35	43	28	34	37	50	26	37
400										50	60	40	47			51	66	39	48	32	38	42	56	29	41
450												44	52					42	52	35	42	46	61	32	45
500												48	56					46	57	38	46	50	67	38	49
550												52	61					50	62	41	50			42	53
600																				44	53			45	57
650																				47	57			47	61
700																				50	60			50	65

Dissipation Watt		Temperature rise [Kelvin]																									
		PS 220 500×500		PS 230 500×750		PS 320 750×500		PS 330 750×750		PS 340 750×1.000		PS 352 750×1.250		PS 420 1.000×500		PS 430 1.000×750		PS 440/442 1.000×1.000		PS 452 1.000×1.250		PS 530 1.250×750		PS 542/546 1.250×1.000			
Watt		Half	Top	Half	Top	Half	Top	Half	Top	Half	Top	Half	Top	Half	Top	Half	Top	Half	Top	Half	Top	Half	Top	Half	Top		
10		6	7	4	5	4	5							4	5												
20		10	12	8	9	8	9	6	8	5	6	4	5	7	8	5	7					4	6				
30		14	16	11	12	11	13							9	11												
40		17	20	13	15	13	16	11	13	9	11	7	9	12	14	9	12	7	9	5	7	7	10	5	7		
50		20	24	16	18	16	20							14	17												
60		24	28	19	21	18	23	15	18	12	15	10	13	16	20	12	16	10	12	8	9	10	14	7	10		
70		27	32	21	24	21	26																				
80		30	35	24	27	23	28	19	23	16	19	13	16	20	25	15	20	12	16	10	12	13	18	9	13		
90		33	39	26	29	25	31																				
100		36	42	28	32	28	34	23	28	19	23	16	19	24	30	18	24	15	19	11	14	15	21	11	15		
120		41	49	33	37	32	39	27	32	22	27	18	22	28	35	21	28					18	24				
140		47	55	37	42	36	45	31	36	24	30	21	25	32	39	24	32	19	25	15	19	20	28	15	20		
160		52	62	41	46	40	50	34	40	27	33	23	28	35	44	27	35					22	31				
180				45	51	44	55	37	44	30	37	25	30	39	48	29	39	23	30	18	23	24	34	18	24		
200				49	55	48	60	41	48	32	40	27	33	42	53	32	42										
220				53	60	52	64	44	52	35	43	30	36	46	57	35	46	28	35	22	27	29	40	21	28		
240								47	56	38	46	32	38	49	61	37	49										
260								50	60	40	49	34	41	52	65	40	52	32	40	25	31	33	45	24	32		
280										43	52	36	43			42	56										
300										45	55	38	46			44	59	35	45	28	34	37	51	27	36		
350												51	63	43	52			50	66	40	51	31	39	42	58	31	41
400														48	58					45	57	35	43	46	64	34	46
450														52	64					49	63	38	48	51	70	38	50
500																				53	68	42	52		41	55	
550																						45	56		44	59	
600																						48	60		48	63	
650																						51	64		51	67	

## General purpose enclosures technical details

PolySafe - Power dissipation values

Dissipation Watt	Temperature rise [Kelvin]																							
	PS 220		PS 230		PS 320		PS 330		PS 340		PS 352		PS 420		PS 430		PS 440/442		PS 452		PS 530		PS 542/546	
	500x500	500x750	750x500	750x750	750x1.000	750x1.250	1.000x500	1.000x750	1.000x1.000	1.000x1.250	1.250x750	1.250x1.000	Half	Top	Half	Top	Half	Top	Half	Top	Half	Top	Half	Top
20	7	9	6	7	6	8	4	6				5	7											
40	13	15	10	13	10	13	8	10	6	8	5	6	8	12	6	8	5	6	4	5	5	7		
60	17	21	14	17	14	19	11	14					11	16	8	11								
80	22	26	17	22	17	23	13	18	10	13	9	11	14	21	10	14	8	11	7	9	8	12	7	9
100	26	31	21	26	20	28	16	21					17	25	12	16								
120	30	36	24	30	24	33	19	25	14	18	12	15	20	28	14	19	11	15	9	12	12	17	9	13
140	34	41	27	34	27	37	21	28					22	32	16	22								
160	38	46	30	38	30	41	24	31	18	23	15	19	25	36	17	24	14	19	12	15	15	21	12	16
180	42	50	33	42	33	45	26	34					27	39	19	26								
200	46	55	36	46	36	49	28	37	21	27	18	23	29	43	21	29	17	22	14	18	17	25	14	19
220	50	59	39	50	38	53	30	40					32	46	23	31								
250			43	55	43	59	34	45	25	33	21	27	35	51	25	34	20	27	17	22	21	30	17	23
300			50	64	49	68	39	52	29	38	25	31	41	59	29	40	23	31	19	25	24	34	19	27
350							44	58	33	43	28	36	46	67	33	45	26	35	22	29	27	39	22	30
400							49	65	37	48	31	40	51	75	36	50	29	39	24	32	30	43	24	34
450							54	71	41	53	34	43			40	55	32	43	27	35	33	48	27	37
500									44	57	37	47			44	60	35	47	29	38	36	52	29	40
550									48	62	40	51			47	65	38	51	32	41	39	56	31	43
600									51	66	43	55			50	69	41	54	34	44	42	60	34	46
700											49	62					46	61	38	50	48	68	38	53
800											54	69					51	68	43	56	53	76	42	58
900																			47	61			47	64
1.000																				51	67		51	70





—  
06

## Accessories

---

**Accessories**

## Index

<b>Accessories</b>	
Heater units	100
Heaters	102
Thermostat	107
Hygrotherm	110
Hygostat	111
Passive cabinet ventilation	112
Ventilation kits	114
General Accessories	116

## General purpose enclosures

### Accessories - Heater units

#### Function

Small heaters for electrical enclosures are important accessories for ensuring the operational safety of control and distribution assemblies.

They are essentially used to prevent the formation of condensation or to ensure that a minimum temperature is maintained inside the electrical enclosures, i.e. at a few degrees above ambient temperature.

#### Operating principle

The small heaters are equipped with PTC heating resistors (semiconductors with a positive temperature coefficient). The self-regulating and self-limiting semiconductor heating elements maintain a constant temperature over the heating surface of the small heaters. The aluminum body transfers heat to the surrounding air through natural radiation. Special extruded profiles guarantee perfect heat radiation.

#### Calculation model for determining the power requirement

According to the formula:  $P = A \times \Delta T \times k$

P = power to be supplied via the resistor (W)

A = exterior free surface of the enclosure (m<sup>2</sup>)

$\Delta T$  = temperature difference between the interior temperature after heating and the exterior temperature in °K.

k = thermal radiation coefficient:

steel: 5.5 W/m<sup>2</sup>K

polyester: 3.5 W/m<sup>2</sup>K

Rule of thumb: recommended value 100 W/m<sup>3</sup> of enclosure volume. The calorific value must be doubled for an exterior installation. Multiple small heaters are preferable to a single heater unit.

#### Advantages

- Energy efficiency
- Dynamic heating
- Self-regulating
- Self-limiting
- Quick clip-in fitting
- Zero maintenance
- Long service life
- Compact unit

#### Standards

EN 60335-1 / EN 62233

UL

EAC

#### Applications

Electrical enclosures, instrumentation units, display panels, control cabinets, ATM machines, access control system for parking lots, etc.

#### Installation

Quick installation on 35 mm DIN rail (EN 50 022). Recommended installation in the lower section of the enclosure, at least 40 mm from the equipment itself.



## General purpose enclosures

### Accessories - Heater units



CSK 060



CS 060



CSF 060

#### CSK 060

Small heating resistor for compact boxes and enclosures, to prevent the formation of condensation or temperatures below a minimum threshold. The resistors have been designed for permanent use.

#### CS 060 / CSF 060

Compact heating resistor to regulate the temperature of cabinets and enclosures containing electrical and electronic components. Due to its construction, it produces optimized natural convection, which generates an effective flow of hot air. The plastic casing has been designed so that the surface temperature remains low. The heating resistor is equipped by default with a fixed-range thermostat. The thermostat connects directly to the heating resistor and requires no additional wiring. The resistors have been designed for permanent use. The resistor is also available as a version without a thermostat (CS 060 series).

#### Technical specifications

Nominal voltage	120-240 V <sup>(1)</sup> AC/DC (min. 110 V, max. 265 V)
Heating element	PTC resistor, self-regulating
Surface temperature	< +85°C (+185°F) (in accordance with VDE 0100), except for the protective grille
Connection	2.5 mm <sup>2</sup> 2-pole terminal, max. tightening torque 0.8 Nm
Box	plastic material in accordance with UL94 V-0, black
Attachment	clip for 35 mm DIN rail, EN 60715
Installation	vertical air flow (blowing upwards/connection below)
Operating/storage temperature	-45 to +70°C (-49 to +158°F)
Operating/storage humidity	max. 90% RH (condensation-free)
Protection rating	IP20/class II (double insulation)
Certification	VDE, UL, EAC
Note:	other voltage options upon request

(1) For power supplies below 140 V AC/DC, heat production is reduced by 10%.

#### Ordering information CSK 060, CS 060

	W <sup>(1)</sup>	I max. (A)	H x W x D (mm)	Weight (kg)	Type	Order code	Pack
CSK 060	10	0.8	98 x 38 x 75	0.2	ACC818225	4TBJ818225C0100	1
	20	2.5	98 x 38 x 75	0.3	ACC818226	4TBJ818226C0100	1
CS 060	50	2.5	110 x 60 x 90	0.3	ACC818227	4TBJ818227C0100	1
	100	4.5	110 x 60 x 90	0.5	ACC818228	4TBJ818228C0100	1
	150	8	150 x 60 x 90	0.5	ACC818229	4TBJ818229C0100	1

(1) Bij omgevingstemperatuur van 20°C

#### Ordering information CSF 060

W <sup>(1)</sup>	I max. (A)	H x W x D (mm)	Cut-out temperature <sup>(2)</sup>	Start-up temperature <sup>(2)</sup>	Weight (kg)	Type	Order code	Pack
50	2.5	110 x 60 x 90	+15°C	+5°C	0.3	ACC818230	4TBJ818230C0100	1
50	2.5	110 x 60 x 90	+25°C	+15°C	0.3	ACC818231	4TBJ818231C0100	1
100	4.5	110 x 60 x 90	+15°C	+5°C	0.3	ACC818232	4TBJ818232C0100	1
100	4.5	110 x 60 x 90	+25°C	+15°C	0.3	ACC818233	4TBJ818233C0100	1
150	8	150 x 60 x 90	+15°C	+5°C	0.5	ACC818234	4TBJ818234C0100	1
150	8	150 x 60 x 90	+25°C	+15°C	0.5	ACC818235	4TBJ818235C0100	1

(1) At an ambient temperature of 20°C

(2) Tolerance of ±5 K

## General purpose enclosures

### Accessories - Heaters



CS 028 / CSL 028

Heating resistor for maintaining a constant temperature inside the enclosures. Prevents malfunctions due to the formation of condensation or ice. Connection via an internal terminal. Thanks to their reduced dimensions, the CS 028 and CSL 028 heating resistors are ideal for installation in enclosures and cabinets with restricted space.

#### Technical specifications

Heating element	PTC resistor, self-regulating
Surface temperature	150 W/250 W: max. +50°C (+122°F), 400 W: max. 65°C (149°F), with the exception of the upper protective grille, for an ambient temperature of +20°C (+68°F)
Axial fan, with ball bearing roller bearing	air flow rate, unimpeded blowing, CS 028: 13.8 m <sup>3</sup> /h (230 V AC), 54 m <sup>3</sup> /h (120 V AC), life cycle 40,000 h at +40 °C (+104°F)
Connection	2.5 mm <sup>2</sup> 2-pole terminal (CSL 028 with cable gland), max. tightening torque 0.8 Nm
Box	plastic material in accordance with UL94 V-0, black
Attachment	clip for 35 mm DIN rail, EN 60715 or screw attachment (Ø 5.3 mm)
Installation	vertical air flow (blowing upwards)
Operating/storage temperature	-45 to +70°C (-49 to +158°F)
Operating/storage humidity	max. 90% RH (condensation-free)
Certification	IP20/class II (double insulation)
Directives	file no. UL E150057 (in accordance with UL 508A, NITW file upon request), EAC, 230 V only: VDE

#### Ordering information CSL 028

Type	Nominal voltage	Heating power <sup>(1)</sup>	Max. start-up current	Fuse (slow-blow)	Dimensions (mm)	Weight (ca) (kg)	Type	Order code	Pack
CS 028	230 V, 50 / 60 Hz	150 W	12.0 A	10.0	75 x 65 x 90	0.3	ACC818242	4TBJ818242C0100	1
CSL 028	230 V, 50 / 60 Hz	250 W	9.0A	10.0	90 x 85 x 111	0.5	ACC818243	4TBJ818243C0100	1
CSL 028	230 V, 50 / 60 Hz	400 W	15.0A	16.0	90 x 85 x 111	0.5	ACC818244	4TBJ818244C0100	1

(1) At an ambient temperature of 20°C

## General purpose enclosures

### Accessories - Heaters



CSF 028

Compact blown-air heating resistor to maintain a constant temperature inside cabinets and enclosures containing electrical and electronic components. Prevents the formation of condensation or ice. Thanks to their reduced dimensions and anti-touch casing, this heating resistor is ideal for installation in enclosures and cabinets with restricted space. CSF 028 is equipped with a pre-set thermostat. Connection via external terminals. The resistor may be installed in two ways: by threaded bracket or by clip. Mounting by threaded bracket is highly robust and is particularly suitable for applications subjected to strong vibration.

#### Technical specifications

Heating element	PTC resistor, self-regulating
Surface temperature	250 W: max. +50°C (+122°F), 400 W: max. +65°C (+149°F) m.u.v. bovenliggend roosteroppervlak bij +20°C (+68°F) omgevingstemperatuur
Temperature limiter	prevents any overheating in the event of fan failure, automatic reactivation
Axial fan, with ball bearing roller bearing	air flow rate, unimpeded blowing, CSF 028: 45 m <sup>3</sup> /h (230 V AC), 54 m <sup>3</sup> /h (120 V AC), life cycle 40,000 h at +40 °C (+104°F)
Connection	2.5 mm <sup>2</sup> double 2-pole spring terminal for solid cable or 1.5 mm <sup>2</sup> for multi-strand wire with terminal connectors
Box	plastic material in accordance with UL94 V-0, black
Attachment	clip for 35 mm DIN rail, EN 60715 or screw attachment (Ø 5.5 mm), max. tightening torque 2 Nm, washers recommended
Installation	vertical air flow (blowing upwards) and horizontal
Dimensions	model with clip/screw attachment: 105x85x118 mm
Weight	model with clip/screw attachment: 0.5 kg
Operating/storage temperature	+40 to +70°C (-40 to +158°F) / -45 to +70°C (-49 to +158°F)
Operating/storage humidity	max. 90% RH (condensation-free)
Usage classification	IP20/class II (total insulation)
Certification	VDE, UL File No. E150057, EAC

#### Ordering information CSF 028

Type	Nominal voltage	Heating power <sup>(1)</sup>	Max. start-up current	Fuse (slow-blow)	Cut-out temperature <sup>(2)</sup>	Start-up temperature <sup>(2)</sup>	Type	Order code	Pack
CSF 028	AC 230 V, 50 / 60 Hz	250 W	9.0	10.0	+15°C (+59°F)	+5°C (+41°F)	ACC818247	4TBJ818247C0100	1
CSF 028	AC 230 V, 50 / 60 Hz	250 W	9.0	10.0	+25°C (+77°F)	+15°C (+59°F)	ACC818248	4TBJ818248C0100	1
CSF 028	AC 230 V, 50 / 60 Hz	400 W	15.0	16.0	+15°C (+59°F)	+5°C (+41°F)	ACC818245	4TBJ818245C0100	1
CSF 028	AC 230 V, 50 / 60 Hz	400 W	15.0	16.0	+25°C (+77°F)	+15°C (+59°F)	ACC818246	4TBJ818246C0100	1

(1) At an ambient temperature of +20°C (+68°F); <sup>2</sup> tolerance ± 5 K

(2) Another start-up/cut-out temperature is available upon request.

## General purpose enclosures

### Accessories - Heaters



HVI 030 without fan



HVI 030

Compact heating resistor to regulate the temperature of cabinets and enclosures containing electrical and electronic components. Prevents malfunctions due to the formation of condensation or ice. The heating resistor may only be used in combination with a fan, but it is also available without an axial fan (self-installation). Choice of screw-attachment model or new rotary clip secured model. The latter is simple and quick to fit.

#### Technical specifications

Nominal voltage	230 V AC, 50 / 60 Hz
Heating element	hoogwaardig verwarmingspatroon
Temperature limiter	prevents any overheating in the event of fan failure, automatic reactivation, additional protection via an irreversible fuse
Axial fan, with ball bearing roller bearing	air flow rate of 150 m <sup>3</sup> /h, unimpeded air flow life cycle 50,000 h at +25 °C (+77°F)
Connection	2.5 mm <sup>2</sup> double 3-pole spring terminal for solid cable or 1.5 mm <sup>2</sup> for multi-strand wire with terminal connectors
Box	plastic material in accordance with UL94 V-0, black
Attachment	rotary clip for 35 mm DIN rail, EN 60715
Installation	vertical air flow (blowing upwards)
Dimensions (HxW xD)	169 x 127 x 89mm
Weight	1.3 kg approximately
Operating temperature	VDE: -10 to +50°C (+14 to +122°F) / UL: -10 to +40°C (+14 to +104°F)
Storage temperature	-45 to +70°C (-49 to +158°F)
Operating/storage humidity	max. 90% RH (condensation-free)
Protection rating	IP20/heating: class II (double insulation), fan: class I (grounded)
Certification	VDE, UL File No. E234324, EAC
Directives	other heating outputs and voltages available upon request

Important instruction: only use resistors with a fan (min. 150 m<sup>3</sup>/h).  
Risk of overheating!

#### Ordering information

	Heating power <sup>(1)</sup>	Type	Order code	Pack
HVI 030	500	ACC818236	4TBJ818236C0100	1
	600	ACC818237	4TBJ818237C0100	1
	700	ACC818238	4TBJ818238C0100	1
HVI 030 without fan	500	ACC818239	4TBJ818239C0100	1
	600	ACC818240	4TBJ818240C0100	1
	700	ACC818241	4TBJ818241C0100	1

(1) At an ambient temperature of 20°C



## General purpose enclosures

### Accessories - Heaters



350 W



475 / 550 W

Semi-conductor heating resistor to regulate the temperature inside electrical cabinets. Prevents malfunctions due to the formation of condensation or ice. The integral thermostat can be used to adjust the temperature.

#### Technical specifications

Nominal voltage	220-240 V AC, 50 / 60 Hz
Heating element	PTC resistor, self-regulating
Temperature limiter	prevents any overheating in the event of fan failure, automatic shut-down
Axial fan, with ball bearing roller bearing	air flow rate: see table, life cycle 50,000 h at +25 °C (+77°F)
Connection	2.5 mm <sup>2</sup> 2-pole terminal, max. tightening torque 0.8 Nm
Box	plastic material UL94 V-0, light gray
On/Off indicator	LED indicator
Attachment	clip voor 35 mm rail DIN, EN 60715
Installation	vertical air flow (blowing upwards)
Dimensions (HxW xD)	100 x 128 x 165 mm
Operating/storage temperature	-45 to +70°C (-49 to +158°F)
Operating/storage humidity	max. 90% RH (condensation-free)
Protection rating	IP20/class II (total insulation)
Certification	VDE, UL File No. E204590, EAC
Directives	other heating outputs and voltages available upon request

#### Ordering information

Nominal voltage	Heating power <sup>(1)</sup> (50 Hz)	Heating power <sup>(1)</sup> (60 Hz)	Max. start-up current	Air flow rate, unimpeded blowing	Temperature regulator adjustment range <sup>(2)</sup>	Weight (approximate)	Type	Order code	Pack
220-240 V AC, 50 / 60Hz	350 W	550 W	8.5A	45 m <sup>3</sup> /h	0°C to +60°C	1.1	ACC818193	4TBJ818193C0100	1
220-240 V AC, 50 / 60Hz	475 W	550 W	11.0A	35 m <sup>3</sup> /h	0°C to +60°C	0.9	ACC818249	4TBJ818249C0100	1
220-240 V AC, 50 / 60Hz	550 W	650 W	13.0A	45 m <sup>3</sup> /h	0°C to +60°C	1.1	ACC818250	4TBJ818250C0100	1

(1) At an ambient temperature of 20°C

(2) 7 K start-up temperature hysteresis (tolerance of ±4 K)

## General purpose enclosures

### Accessories - Heaters



CR 130

Powerful heating resistor to regulate the temperature of cabinets and enclosures containing electrical and electronic components. Prevents malfunctions due to the formation of condensation or ice. The plastic casing provides protection against burns when coming into contact with hot parts. The heating resistor is available with an integral temperature regulator or a fixed-range hygrostat.

#### Technical specifications

Heating element	PTC resistor, self-regulating
Temperature limiter	prevents any overheating in the event of fan failure, automatic shut-down
Axial fan, with ball bearing roller bearing	air flow rate of 160 m <sup>3</sup> /h, unimpeded air flow life cycle 50,000 h at 25 °C (77°F)
Connection	2.5 mm <sup>2</sup> max. 2-pole with securing bolt cable gland, max. tightening torque 0.8 NM
Box	plastic material in accordance with UL94 V-0, black
Attachment	clip attachment for 35 mm DIN rail, EN 60715 or screw attachment (M6)
Installation	vertical air flow (blowing upwards) + other
Dimensions	182 x 160 x 120 mm
Weight	1.3 kg approximately
Operating/storage temperature	-45 to +70°C (-49 to +158°F)
Operating/storage humidity	max. 90% RH (condensation-free)
Protection rating	IP20/class II (total insulation)

#### Ordering information CS 130

Type	Nominal voltage	Heating power <sup>(1)</sup>	Adjustment range <sup>(2)</sup>	Fuse T (slow-blow)	Dimensions (mm)	Weight (approximate)	Type	Order code	Pack
CR 130	AC 230 V, 50 / 60Hz	950W	0°C to +60°C	6.3A	99 x 160 x 182	1.5	ACC818251	4TBJ818251C0100	1
CS 130	AC 230 V, 50 / 60Hz	1200W	Resistor without thermostat	10.0A	120 x 160 x 182	1.3	ACC818253	4TBJ818253C0100	1

(1) At an ambient temperature of 20°C

(2) 7 K start-up temperature hysteresis (tolerance of ±4 K)

## General purpose enclosures

### Accessories - Thermostat



KTO



KTS

#### Function

KTO and KTS elements regulate and control the temperature inside the enclosure by controlling the small heaters, fans, heat exchangers and cooling units.

#### KTO 011

Thermostat (contact normally closed) for heating resistor regulation. The contact is opened when the temperature increases.

#### KTS 011

Thermostat (contact normally open) for regulating filter fans, heat exchangers and air conditioning units or for triggering signals when the temperature threshold is exceeded. The contact is closed when the temperature increases.

#### Technical specifications

Type	KTO	KTS
Adjustment range:	+10 - +50°C or 0 - +60°C	+10 - +50°C or 0 - +60°C
hysteresis temperature	7 K (±4 K tolerance)	7 K (±4 K tolerance)
Contact type	NC	NO
Power	250 V AC, 10 (2) A 120 V AC, 15 (2) A 30 W DC on 24 V DC to 72 V DC	250 V AC, 10 (2) A 120 V AC, 15 (2) A 30 W DC on 24 V DC to 72 V DC
Max. start-up current	16 A AC for 10 s	16 A AC for 10 s
Weight	36 g	36 g
Dimensions (HxW xD) mm	60 x 33 x 43 mm	60 x 33 x 43 mm
Wiring diagram	red button: heating	blue button: cooling, ventilation, alarm signal
Protection rating	IP20	IP20
Connection	2-pole terminal, max. tightening torque 0.5 Nm: 2.5 mm <sup>2</sup> solid cable (AWG 16), 1.5 mm <sup>2</sup> flexible cable (AWG 14)	
Installation	clip for 35 mm DIN rail, EN 60715	
Box	plastic material UL94 V-0, light gray	
Anti-interference	N in accordance with VDE 0875	

Values between parentheses: inductive load  $\cos \varphi = 0.80$

#### Connection diagram

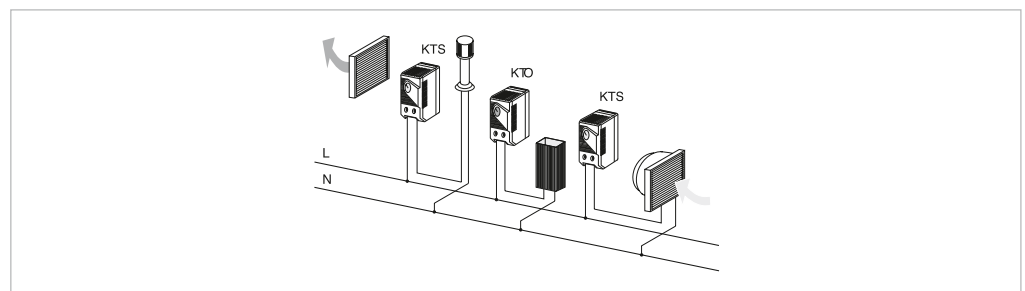
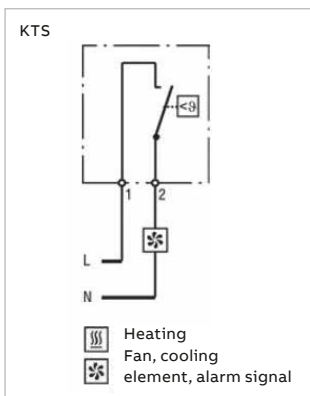
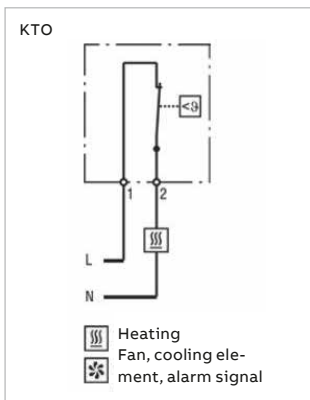

#### Ordering information

	Temperature	Type	Order code	Pack
KTO	-10° to +50°C	ACC818265	4TBJ818265C0100	1
KTO	0° to +60°C	ACC818080	4TBJ818080C0100	1
KTS	-10° to +50°C	ACC818266	4TBJ818266C0100	1
KTS	0° to +60°C	ACC818081	4TBJ818081C0100	1

## General purpose enclosures

### Accessories - Thermostat



FZK 011



ZR 011



ETR 011

#### Connection diagram

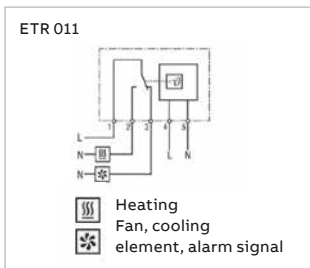
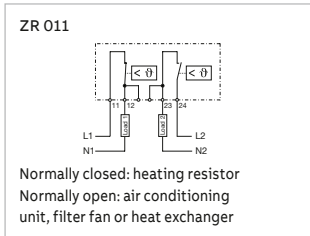
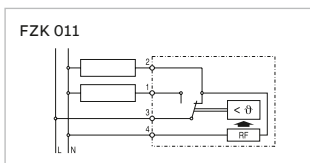

#### Function

FZK 011, ZR 011 and ETR 011 elements regulate and control the temperature inside the enclosure by controlling the small heaters, fans, heat exchangers and cooling units.

#### FZK 011

Mechanical thermostat used for controlling heating resistors, air conditioning units, filter fans or signaling. It obtains ambient temperature readings and can switch resistive and inductive loads thanks to its snap switching.

#### ZR 011

Two thermostats in one unit:

- thermostat (contact normally closed) for heating resistor regulation.;
  - thermostat (contact normally open) for regulating filter fans, heat exchangers and air conditioning units or for triggering signals when the temperature threshold is exceeded.
- Unlike a thermostat with inverter switch, the dual thermostat allows the heating resistor and air conditioning unit to be connected independently at different temperature ranges.

#### ETR 011

The mechanical thermostat is used for controlling heating resistors, air conditioning units, filter fans or signaling. The thermostat obtains ambient temperature readings and can switch resistive and inductive loads thanks to its inverter switch (relay). The LED integral to the adjustment button lights up when the contact is closed (when the heating resistor is in operation, for example).

#### Technical specifications

Type	FZK 011	ZR 011	ETR 011
Adjustment range:	+5 to +60°C or -20 - +35°C	0 to 60°C	+20°C
hysteresis temperature	0.5 K	7 K	4 K (±1 K tolerance)
Contact type	switching contact: single-pole	NC	NO
Power	NC 10 A (4) 250 V AC NO 5 A (2) 250 V AC Resistive load	10 A (2) 250 V AC Resistive load	AC 240 V, 8 (1.6) A AC 120 V, 8 (1.6) DC 100 W to DC 24 V
Max. start-up current	-	-	16 A AC for 10 s
Weight	100g	90g	70g
Dimensions (HxWxD) mm	67 x 50 x 38	60 x 50 x 46	64.5 x 42 x 38
Wiring diagram	(see left)	(see left)	/
Protection rating	IP20	IP20	IP20
Connection	2-pole terminal, max. tightening torque 0.5 Nm: 2.5 mm <sup>2</sup> solid cable (AWG 14) 1.5 mm <sup>2</sup> flexible cable (AWG 16)		
Installation	clip for 35 mm DIN rail, EN 60715		
Box	plastic material UL94 V-0, light gray		
Anti-interference	N in accordance with VDE 0875		

Values between parentheses = inductive load  $\cos \varphi = 0.8$

#### Ordering information

	Temperature	Type	Order code	Pack
FZK 011	+5° to +60°C	ACC818079	4TBJ818079C0100	1
FZK 011	-20° to +35°C	ACC818269	4TBJ818269C0100	1
ZR 011	0° to +60°C	ACC818217	4TBJ818217C0100	1

(1) At an ambient temperature of 20°C

## General purpose enclosures

### Accessories - Thermostat



FTO 011



FTS 011

#### Function

The mechanical thermostat is a dual switch with low hysteresis. The thumb wheel is for anti-icing adjustment. The casing ensures optimal air circulation around the bimetallic element.

#### STO 011

Thermostat (contact normally closed) for heating resistor regulation. The contact is opened when the temperature increases.

#### STS 011

Thermostat (contact normally open) for regulating filter fans, heat exchangers and air conditioning units or for triggering signals when the temperature threshold is exceeded. The contact is closed when the temperature increases.

#### Technical specifications

Type	
Hysteresis	4 K ( $\pm 3$ K tolerance)
Heat sensor	with bimetal element
Contact type	snap switching
Life cycle	> 100,000 cycles
Power	250 V AC, 10 (2) A 120 V AC, 15 (2) A 30 W DC on 24 V DC to 72 V DC
Max. start-up current	16 A AC for 10 s
Connection	2-pole terminal, max. tightening torque 1 Nm: 2.5 mm <sup>2</sup> flexible/solid cable (AWG 14)
Attachment	clip for 35 mm DIN rail, EN 60715
Box	plastic material UL94 V-0, light gray
Dimensions	70 x 33 x 42 mm
Weight	50g approximately
Installation	mandatory
Operating/storage temperature	-45 to +80°C (-49 to +176°F)
Operating/storage humidity	max. 90% RH (condensation-free)
Protection rating	IP20
Certification	VDE, UL File No. E164102, EAC

#### Connection diagram

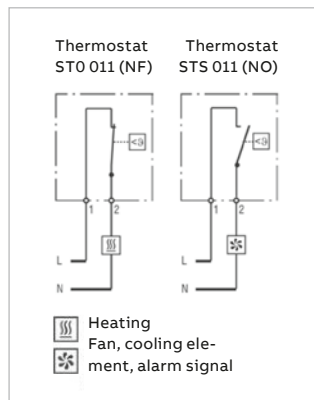

#### Ordering information

	Contact	Temperature	Type	Order code	Pack
STO 011	NC	0° to 60°C	ACC818267	4TBJ818267C0100	1
STS 011	NO	0° to 60°C	ACC818268	4TBJ818268C0100	1

## General purpose enclosures

### Accessories - Hygrotherm



ETF 012

The hygrostat/thermostat measures both temperature and humidity, and is able to activate heating or cooling independently.

#### Technical specifications

Adjustment range:	
- Temperature	0°C to 60°C
- Hysteresis	2K
- Relative humidity of the air	50% to 90%
- Rest time	160 secs.
Power supply voltage	100-240 V / 50-60 Hz
Contact type	relay output: NO/NF switch
Power output <sup>(1)</sup>	8 A (4) 250 V AC 0.5 A 100 V DC 8 A 12 V DC 5 A 35 V DC
On/Off indicator	LED
Weight	140 g
Dimensions (HxW xD)	50 x 67 x 43 mm
Protection rating	IP20
Connection	2.5 mm <sup>2</sup> screw-in terminals
Attachment	35 mm DIN rail( EN 50022)
Box	plastic UL 94 V0
Anti-interference	N in accordance with VDE 0875

(1) Values between parentheses: inductive load  $\cos \varphi = 0.80$

#### Ordering information

	Type	Order code	Pack
ETF 012	ACC818083	4TBJ818083C0100	1
ETF 012 with external sensor	ACC818271	4TBJ818271C0100	1

#### Connection diagram

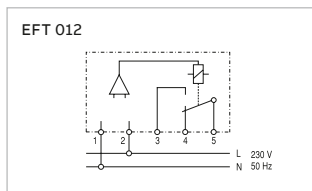

## General purpose enclosures

### Accessories - Hygrostat



MFR 012



EFR 012

The humidity regulator is designed to control the temperature and air humidity inside the enclosure. The regulator is activated when the humidity level reaches 65%. In doing so, the system efficiently prevents the risk of condensation and corrosion.

#### Technical specifications

	MFR 012	EFR 012
Adjustment range	35 to 95% RV	40 to 90% RV
Switching hysteresis	tolerance of $\pm 3$ % RH	tolerance of $\pm 3$ % RH
Nominal voltage	250 V AC	230 V AC, 50/60 Hz
Switching capacity, max. load:		
- Resistive load	5 A 250 V	240 V AC, 8 (1.6) A
- Inductive load $\cos \varphi$ 0.8	0.2 A 250 V AC	120 V AC, 8 (1.6) A
- Inductive load L/R = 3 ms	1 A 50 V DC to 75 V DC	100 W AC to 24 V DC
Switching capacity, min. load:	100 mA DC / AC 20 V	
Contact type	CO NO / NC	CO (relay)
Connection	terminal plate inside the casing, 3 x 2.5 mm <sup>2</sup>	5-pole terminal, max. tightening torque 0.5 Nm: 2.5 mm <sup>2</sup> solid/flexible cable (AWG 14)
Box	plastic, light gray	plastic material UL94 V-0, light gray
Installation	35 mm DIN rail	clip for 35 mm DIN rail, EN 60715
Protection rating	IP20	IP20
Dimensions (HxW xD)	67 x 50 x 38 mm	64.5 x 42 x 38 mm
Weight	60 g	70 g

(1) Values between parentheses: inductive load  $\cos \varphi = 0.80$

#### Ordering information

	Type	Order code	Pack
MFR 012	ACC818190	4TBJ818190C0100	1
EFR 012	ACC818270	4TBJ818270C0100	1

#### Connection diagram

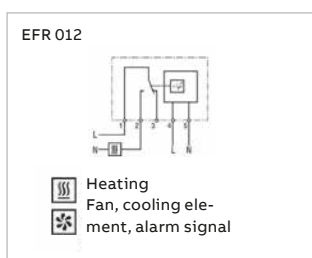
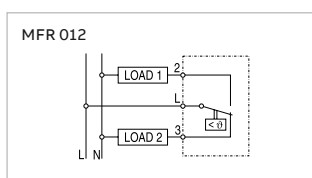

## General purpose enclosures

### Accessories - Passive cabinet ventilation

The differences between ambient temperature and the temperature inside a cabinet with a high protection rating may generate variations in pressure. In the event of under-pressure, the cabinet may draw in dust and moisture. Any moisture trapped inside the cabinet will be deposited as condensation. This condensation can be prevented through the use of ventilation grilles.

Product	Type	Order code	Pack
<b>IP44 ventilation grille</b>			
Suitable for a ventilation opening Includes 2 grilles and 4 nylon nails. Total insulation.			



2000mm <sup>2</sup> grille	PS832019	4TBP832019C0100	1
----------------------------	----------	-----------------	---

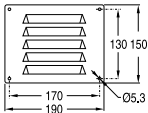

3000mm <sup>2</sup> grille	PS832743	4TBP832743C0100	1
----------------------------	----------	-----------------	---

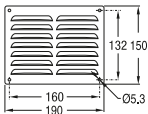

4500mm <sup>2</sup> grille	PS832744	4TBP832744C0100	1
----------------------------	----------	-----------------	---

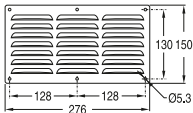

#### IP44 vent (RAL 7035)

In order to guarantee sufficient ventilation and to avoid condensation, two vents must be installed; one at the top and a second one at the bottom. Kit includes: drilling template.

Set of 2 polyamide pieces	PS833677	4TBP833677C0100	1
---------------------------	----------	-----------------	---



#### Vents (IPx4)

Improve ventilation and prevent condensation. Recommended installation above or below the cabinet - M20

MB861728	4TBG861728R0100	25
----------	-----------------	----



Product	Type	Order code	Pack
<b>IP55 pressure compensation plug</b>			

Hermetically sealed cabinets and enclosures are subjected to thermal or exterior influences, which result in temperature fluctuations during changes in pressure. Pressure compensation plugs compensate for changes in pressure and prevent the ingress of dust and moisture. The plug is suitable for use in electrical cabinets and enclosures, in accordance with the DIN EN 62208 standard.

Set of 2 pieces	ACC818078	4TBJ818078R0100	1
-----------------	-----------	-----------------	---

#### Technical specifications

Dimensions	ø 65.5 mm x 30.5 mm
Cut-out	ø 37 mm
Attachment	PG 29 threaded or nut
Material	ABS/PC
Air inlet	±1.5 cm <sup>2</sup>
Protection rating	IP55

Note: compensation for optimal pressure revolves around the use of 2 plugs, diagonally opposed. If the plug is not installed vertically, the protection rating is reduced to IP54.



#### Vents - IP44<sup>(1)</sup>

Set of 2 pieces, bore diameter Ø 34.9 mm	AR831009	4TBA831009C0100	1
--	----------	-----------------	---



(1) If positioned in the corners of an Aria cabinet or under the hood of a PolySafe cabinet





## General purpose enclosures

### Accessories - Passive cabinet ventilation

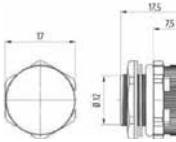

Product	Type	Order code	Pack
<b>Pressure regulator plug - IP66</b>			
Set of 2 pieces			
	M40	ACC818223	4TBJ818223R0100 1
Highly resistant to poor weather conditions and UV, compliant with the UL746C standard	M40	ACC870418	4TBJ870418C0100 1
	M12	ACC818287	4TBJ818287C0100 1

Installation	M40 x 1.5 or M12 x 1.5 thread with nut.
Torque	M40: 5 Nm, M12: 0.5 Nm
Mounting depth	M40: approximately 16 mm, M12: approximately 8 mm
Sealing	NBR seal
Filter	waterproof membrane
Dimensions	M40: Ø 60 x 37 mm, M12: Ø 17 x 17.5 mm
Installation	mandatory
Certification	UL (870418), EAC

<b>Pressure compensation plug - IP66</b>			
STAINLESS AISI 304	ACC818288	4TBJ818288C0100	1
STAINLESS AISI 304	ACC818289	4TBJ818289C0100	1
STAINLESS AISI 316L	ACC818290	4TBJ818290C0100	1

			
---	---	---	---

Installation	M40 x 1.5 thread with nut.
Torque	5 Nm
Mounting depth	9 mm approximately
Sealing	NBR seal
Filter	waterproof membrane
Air permeability	1200 l/h with a pressure difference of 70 mbar min.
Dimensions	Ø 58 x 31 mm
Installation	mandatory
Operating/storage temperature	-45 to +80°C (-49 to +176°F)
Certification	EAC

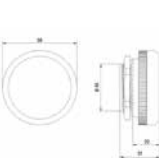
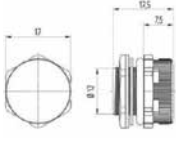
### DAK 284

Product	Type	Order code	Pack
<b>Ventilated cable gland - IP66/IP67</b>			
<b>Air permeability</b>		<b>Torque</b>	
25 l/h	M12 2Nm	ACC818291	4TBJ818291C0100 1
25 l/h	M16 2Nm	ACC818292	4TBJ818292C0100 1
40 l/h	M20 5Nm	ACC818293	4TBJ818293C0100 1

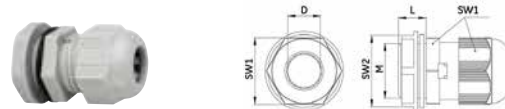

Installation	M12 x 1.5 / M16 x 1.5 / M20 x 1.5 thread
Mounting depth	0.5 – 3 mm with nut
Material	plastic, light gray
Protection rating	IP66 / IP67 (EN 60529)
Sealing	NBR seal
Filter	PTFE
Installation	mandatory
Operating/storage temperature	-20 to +80°C (-4 to +176°F)
Certification	VDE, UL, EAC

### Dimensions (mm)

Type	ACC818291	ACC818292	ACC818293
<b>Order code</b>	4TBJ818291C0100	4TBJ818292C0100	4TBJ818293C0100
	M12	M16	M20
L	8	10	10
D	4 - 8	4 - 8	6 - 12
SW1	19	19	24
SW2	18	22	26

### DD 084

Product	Type	Order code	Pack
<b>Drainage plug - IP66/IP67/IP69K</b>			
	AC818294	4TBJ818294C0100	1

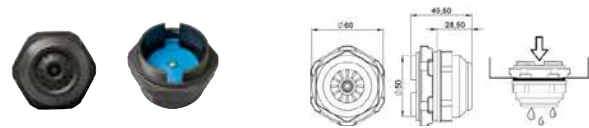

Torque	M12 x 1.5 / M16 x 1.5 / M20 x 1.5 thread
Mounting depth	0.5 – 3 mm with nut
Material	plastic in accordance with UL94 V-0, dark gray, highly resistant to poor weather conditions and UV, compliant with the UL746C standard
Protection rating	IP66 / IP67 (EN 60529)
Sealing	NBR seal
Filter	PTFE
Installation	mandatory
Operating/storage temperature	-20 to +80°C (-4 to +176°F)
Certification	VDE, UL, EAC

Installation instructions: drill a Ø 50.5+ mm hole in the lower section of the enclosure and install the drainage system with a nut. Important: the hole must have no burred edges and the seal must be fitted on the exterior side of the enclosure.

## General purpose enclosures



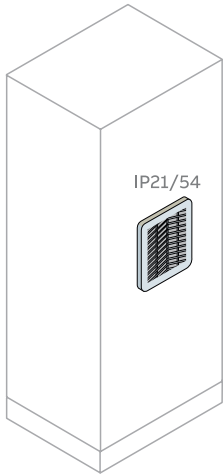

### Accessories - Ventilation kits



#### Temperature management

##### IP21/54 natural ventilation kit

Gratings made of insulating material (self-extinguishing ABS UL94V-0) RAL7035 colour, complete with high dust collection capacity filter cloth (600g/m<sup>2</sup>), able to reduce maintenance interventions (cleaning by means of washing in water or by beating). Degree of protection IP21 without filter, IP54 with filter according to IEC 60529, Type 1 without filter, Type 12 with filter according to UL approval 508 fitted with pre-assembled gasket seal. CE and cURus approval.

Air entry surface for ventilation		Dimensions (mm)		Type	Order code	Package/ No. of pieces
Without filter cm <sup>2</sup>	With filter cm <sup>2</sup>	W	H			
<b>Grille+air passage filter kit</b>						
27	6	105	105	 EN0105K		1/1
53	10	150	150	 EN0150K		1/1
121	22	204	204	 EN0204K		1/1
225	32	250	250	 EN0250K		1/1
317	55	325	325	 EN0325K		1/1

## General purpose enclosures



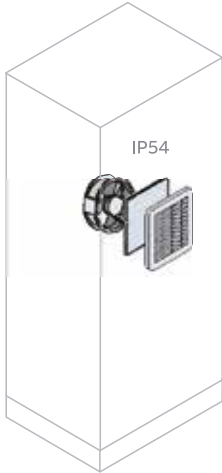





### Accessories - Ventilation kits



#### Temperature management

##### IP54 forced ventilation Kit

Grilles made of insulating material (ABS self-extinguishing UL94V-0) RAL7035 colour, complete with filter cloth with high dust accumulation capacity (600g/m<sup>2</sup>), able to reduce maintenance interventions (cleaning by washing with water or beating). IP54 degree of protection with filter according to UL approval 508 fitted with pre-mounted tightness gasket. Operating temperature -10 °C + 50 °C. The fans allow reversible flow of air. CE and cURus (see mark) approval.

Air entry surface for ventilation		Dimensions (mm)		Type	Order code	Package/ No. of pieces
Consumption 50/60Hz (W)	Capacity 50/60Hz (m <sup>3</sup> /h)	W	H			
<b>Ventilation filter with IP54 230V ~ fan</b>						
10/8	23/30	105	105	 EN1105K		1/1
20/19	57/61	150	150	 EN1150K		1/1
17/15	120/135	204	204	 EN1204K		1/1
29/29	240/270	250	250	 EN1250K		1/1
67/87	520/580	325	325		EN2325K	1/1
<b>Ventilation filter with IP 54 1150V~ fan</b>						
9/7	23/30	105	105	 EN2105K		1/1
20/18	57/61	150	150	 EN2150K		1/1
17/15	120/135	200	200	 EN2204K		1/1
30/30	240/270	250	250	 EN2250K		1/1
50/64	520/580	325	325		EN3325K	1/1

## General purpose enclosures

### Accessories - General Accessories

Cable gland - PG - IP54 polycarbonate (gray)										
PG	D1 (mm)	Drill diameter ∅ (mm)	D3	D5	L5	S1	S2	Type	Order code	Pack
11	18.6	19	11	24	8	19	22	APACC851038	4TBO851038C0100	50
13.5	20.4	21	13	26.5	9	21	24	APACC851042	4TBO851042C0100	50
16	22.5	23	16	29.5	10	23	27	APACC851046	4TBO851046C0100	50
21	28.3	29	21	35	11	30	32	APACC851051	4TBO851051C0100	25
29	37	38	27.5	45	11	41	42	APACC851056	4TBO851056C0100	10
36	47	48	34	57	13	50	53	APACC851060	4TBO851060C0100	5
42	54	55	42	64	12.5	55	60	APACC851062	4TBO851062C0100	5

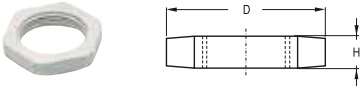
Nuts - Polycarbonate (gray)		PG	D	H	Type	Order code	Pack
		11	25	5	APACC851075	4TBO851075C0100	50
		13.5	27.5	5.5	APACC851076	4TBO851076C0100	50
		16	31	6	APACC851077	4TBO851077C0100	50

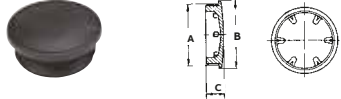



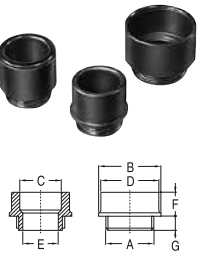

Plugs (black)		A	B	C	Type	Order code	Pack
		PG16	26	11	APACC851064	4TBO851064C0100	50
		PG21	32	11.5	APACC851065	4TBO851065C0100	50
		PG29	41	13	APACC851066	4TBO851066C0100	50
		PG36	51	12.5	APACC851068	4TBO851068C0100	50

Pipe entries - Non-threaded (black)										
Pipe ∅	A	B	C	D	E	F	G	Type	Order code	Pack
5 / 8"	PG-16	26	17	21	14.1	15	9	APACC851069	4TBO851069C0100	20
3 / 4"	PG-16	26	20	24	16	21	9	APACC851070	4TBO851070C0100	20

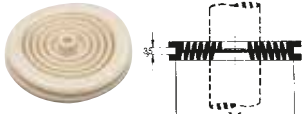
Pipe entries - Non-threaded (black)											
Pipe ∅	A	B	C	D	E	F	G	Type	Order code	Pack	
	5 / 8"	PG-16	26	17	21	14.1	15	9	FOB61TUB3	4TBB600933C0200	25
	3 / 4"	PG-16	26	20	24	16	21	9	FOB61TUB4	4TBB600934C0200	25

## General purpose enclosures







### Accessories - General Accessories

Universal entries (gray)								
		Cable Ø max.	PG	Drill diameter Ø (mm)	Color	Type	Order code	Pack
		18	16	23	gray	FORJRPG16	4TBR610130C0200	25
		24	21	29	gray	FORJRPG21	4TBR610132C0200	25
		32	29	38	gray	FORJRPG29	4TBR610133C0200	25
		49	42	54	gray	APACC852191	4TBO852191C0100	1
		12	48	55	gray	APACC851096	4TBO851096C0100	20
		12	30	35	gray	APACC851097	4TBO851097C0100	20
		12	36	45	gray	APACC851098	4TBO851098C0100	20
		22	66	75	gray	APACC851099	4TBO851099C0100	10
		22	58	65	gray	APACC851100	4TBO851100C0100	10
Railstellen						Type	Order code	Pack
	- RSTN busbars - I = 63 A - Busbar cross-section 6.5x9 - DIN rail mounting - Peak current: 15 kA (10 msec)					ACC610022	4TBR610022C0200	18
		- RSTN busbars - Busbar cross-section 12x5 - I = 160A - DIN rail mounting - Peak current: 35kA (10 msec)					ACC610020	4TBR610020C0200
		- Protective screen for 610020					ACC610021	4TBR610021C0200
	- Busbars 12x5 - Length 1.2 m + 50 jumpers and 50 screws - Maximum span: 200mm - To be combined with 610018 supports					ACC610017	4TBC610017C0100	10
	- Busbar support for four 12x5 busbars - Max. spacing of supports: max. 200mm - DIN rail mounting - To be combined with the busbars above					ACC610018	4TBC610018C0100	1

(1) The ACC610017 and ACC610018 assembly has a peak current of: 15 kA (10 msec)



## General purpose enclosures

### Accessories - General Accessories

Busbar/cable terminals		Type	Order code	Pack			
	<b>With 4 bypasses</b> - For Al/Cu cable - Max. thickness: 12 mm - Width: unlimited	35-70 mm <sup>2</sup> + 4 bypasses (16 mm <sup>2</sup> )					
		2 cables	ACC779221	4TBC779221C0100	4		
		3 cables	ACC779222	4TBC779222C0100	4		
		90-150 mm <sup>2</sup> + 4 bypasses (25 mm <sup>2</sup> )					
		2 cables	ACC779218	4TBC779218C0100	4		
		3 cables	ACC779219	4TBC779219C0100	4		
Rubber insulation cap		Type	Order code	Pack			
	For 35-70 mm <sup>2</sup> terminal		ACC779224	4TBC779224C0100	4		
	For 95-150 mm <sup>2</sup> terminal		ACC779223	4TBC779223C0100	4		
Connection busbars		Type	Order code	Pack			
	- Phase - black - 6x10mm <sup>2</sup> and 2x16 mm <sup>2</sup> - Interlocking on flat bar 12 x 2 mm	FORSTTL	4TBR610185C0200	4			
	- Ground - green - 6x10mm <sup>2</sup> and 2x16 mm <sup>2</sup> - Interlocking on flat bar 12 x 2 mm	FORSTTPE	4TBR610186C0200	4			
	- Neutral - blue - 6x10mm <sup>2</sup> and 2x16 mm <sup>2</sup> - Interlocking on flat bar 12 x 2 mm	FORSTTN	4TBR610187C0200	4			
	- 14 x 16 mm <sup>2</sup> - DIN rail mounting	ACC610065	4TBC610065C0100	4			
	- Ground busbar - 12 x 4 with 3 terminals - Screw fixing	APACC851021	4TBO851021C0100	4			
Busbar/busbar terminals		Type	Order code	Pack			
	Main busbar	Secondary busbars	Min. total thickness	Clamped bars			
	20	15 - 20	5 - 4	26 - 24	APACC851120	4TBO851120C0100	10
30	15 - 20 - 30	7 - 6 - 5	28 - 27 - 26	APACC851129	4TBO851129C0100	10	



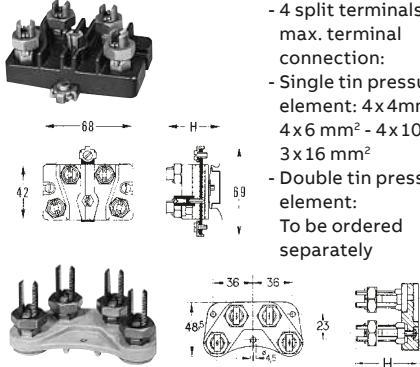



## General purpose enclosures

### Accessories - General Accessories

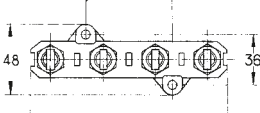
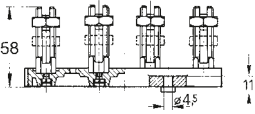
Busbar/busbar terminals							
	Cable max. Ø (mm <sup>2</sup> )	Busbar thickness (mm)	Busbar width (mm)	Type	Order code	Pack	
	10 to 50	5 to 6	30	APACC851117	4TBO851117C0100	10	
	4 to 35	3 to 5	15	APACC851118	4TBO851118C0100	10	
Terminal rosettes for 10-16 mm <sup>2</sup> Al and Cu cable							
		Attachment	Ground clamp	H	Type	Order code	Pack
 <p>- 4 split terminals with max. terminal connection: - Single tin pressure element: 4 x 4 mm<sup>2</sup> - 4 x 6 mm<sup>2</sup> - 4 x 10 mm<sup>2</sup> - 3 x 16 mm<sup>2</sup> - Double tin pressure element: To be ordered separately</p>		screw-fit	none	46	ACC779212	4TBC779212C0100	5
		on DIN rail	none	48	ACC779213	4TBC779213C0100	5
		screw-fit	included	46	ACC779214	4TBC779214C0100	5
		on DIN rail	included	48	ACC779215	4TBC779215C0100	5
		screw-fit	none	48	ACC890705	4TBC890705C0100	5
Double pressure element							
		Set of 4 securing nuts			ACC779216	4TBC779216C0100	1
Insulation cap							
		Made of rubber			ACC890704	4TBC890704C0100	20

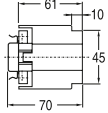
## General purpose enclosures

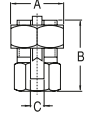
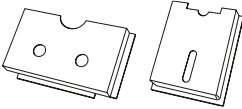









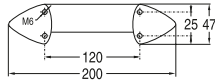

### Accessories - General Accessories

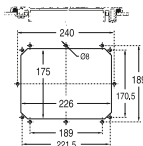
25-35 mm <sup>2</sup> terminal blocks					Type	Order code	Pack			
  	- Without insulation caps				ACC779201	4TBC779201C0100	10			
	- 1 securing nut									
	- Al/Cu cable									
	- 2 securing nuts				ACC779202	4TBC779202C0100	10			
- Al/Cu cable										
- With insulation caps				ACC779204	4TBC779204C0100	10				
- 2 securing nuts										
- Al/Cu cable										
- With insulation caps and attachment				ACC779205	4TBC779205C0100	10				
- 2 securing nuts										
- Al/Cu cable										
Insulation cap					Type	Order code	Pack			
 					ACC890838	4TBC890838C0100	10			
Double pressure element					Type	Order code	Pack			
Set of 4 securing nuts					ACC779203	4TBC779203C0100	10			
Cable clamps for overhead lines		Cross-section	A	B	C	Type	Order code	Pack		
 		10 mm <sup>2</sup>	14	24	4.5	KIM601227	2CDB710029R0000	100		
		16 mm <sup>2</sup>	22	29	5.5	KIM601228	2CDB710019R0000	50		
		35 mm <sup>2</sup>	25	35	7.5	KIM601229	2CDB710022R0000	25		
		50 mm <sup>2</sup>	28	43.5	9.0	KIM601230	2CDB710031R0000	25		
Document pocket					Type	Order code	Pack			
					DIN A4, 325 B x 180 H, self-adhesive - gray			PS811516	4TBC811516C0100	1
					DIN A5, 155 B x 225 H, self-adhesive - transparent			PS832000	4TBP832000C0100	1
Insulated cover plate (color: orange)					Type	Order code	Pack			
					Thickness 3mm, 1900 x 900 x 3mm			ACC811096	4TBC811096C0100	1

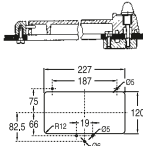

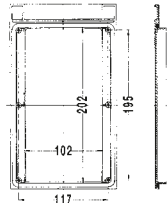
## General purpose enclosures

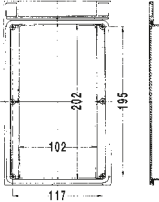
### Accessories - General Accessories

Module covers	Type	Order code	Pack	
	12 modules, sectionable by 1/2 module			
	ZA3P5	4TBR610142C0200	5	
<hr/>				
Handle	Type	Order code	Pack	
 	Height 50 mm, with reinforcement molding + Vyncolite screws			
	APACC851244	4TBO851244C0100	1	
<hr/>				
IP54 windows	Type	Order code	Pack	
 	Includes a template and fixings			
	77x60 mm - 2 mod.	ACCWD2M	4TBO861395C0100	1
	77x96 mm - 4 mod.	ACCWD4M	4TBO861396C0100	1
	77x130 mm - 6 mod.	ACCWD6M	4TBO861397C0100	1
	77x163 mm - 8 mod.	ACCWD8M	4TBO861398C0100	1
	Screw-fit IP67	AP9X7WD	4TBO866001C0100	1
 				
	With hinges and seal IP55			
	77x60 mm - 2 mod.	APACC890837	4TBO890837C0100	1
<hr/>				
 	Screw-fit IP67, with label holders			
		AP8X4WDL	4TBO866002C0100	1
<hr/>				
 	Screw-fit IP67, without label holders			
		AP8X4WD	4TBO866003C0100	1
				

## General purpose enclosures

### Accessories - General Accessories

M4 type rise pillars	L (mm)	Ø A	Ø B	Type	Order code	Pack
	10	M4	M4	APACC890800	4TBO890800C0100	50
	15	M4	M4	APACC890801	4TBO890801C0100	50
	20	M4	M4	APACC890802	4TBO890802C0100	50
	25	M4	M4	APACC890803	4TBO890803C0100	50
	30	M4	M4	APACC890804	4TBO890804C0100	50
	60	M4	M4	APACC890805	4TBO890805C0100	50
	65	M4	M4	APACC890806	4TBO890806C0100	50
	97	M4	M4	APACC890807	4TBO890807C0100	20
	102	M4	M4	APACC890808	4TBO890808C0100	20

M6 type rise pillars	L (mm)	Ø	Type	Order code	Pack
	15	M6-M6	ACC811337	4TBC811337C0100	100
	20	M6-M6	ACC811338	4TBC811338C0100	100
	25	M6-M6	ACC811454	4TBC811454R0100	100
	30	M6-M6	ACC811339	4TBC811339C0100	100
	35	M6-M6	ACC811455	4TBC811455R0100	100
	45	M6-M6	PS811456	4TBP811456R0100	100
	55	M6-M6	ACC811457	4TBC811457R0100	100
	65	M6-M6	ACC811458	4TBC811458R0100	100
	70	M6-M6	ACC811340	4TBC811340C0100	100
	80	M6-M6	ACC811460	4TBC811460R0100	100
	100	M6-M6	ACC811461	4TBC811461R0100	100
	120	M6-M6	ACC811341	4TBC811341C0100	100

M6 type rise pillars	L (mm)	Ø	Type	Order code	Pack
	60	M6-M6	ACC811342	4TBC811342C0100	100
	30	M6-M6	ACC811343	4TBC811343C0100	100

M4-M6 Type	L (mm)	Ø	Type	Order code	Pack
	15	M6-M4	ACC811336	4TBC811336C0100	100

Insulated cap nuts (RAL 7035 Light Gray)	A	B	C	D	Ø E	Type	Order code	Pack	
	M4	15	13.5	8.5	M4	11	KIM601223	2CDB601223R0000	100
	M5	18	17.0	10	M5	14	KIM601224	4TBS601224C0200	100
	M6	22.3	20.4	9	M6	17	KIM601225N	4TBC601225C0100	100
	M8	25.3	24.2	10	M8	20	KIM601226	2CDB601226R0000	50

## General purpose enclosures

### Accessories - General Accessories

#### Locks with semi-cylindrical profile M4 Type

Standard: D = 40 mm - L = 30.5 mm

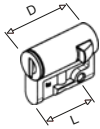

	Type	Order code	Pack
With 2 keys V2432-E	PS832030	4TBP832030C0100	1
With 2 keys 1242-E	PS832031	4TBP832031C0100	1
With 2 keys 455-E	PS832465	4TBP832465C0100	1
With 2 keys 405-E	PS832466	4TBP832466R0100	1
With 1 square key, 8 mm	PS832032	4TBP832032C0100	1
With 1 square key, 8 mm	PS832033	4TBP832033C0100	1
With 1 square key, 11 mm	PS832034	4TBP832034C0100	1
With 1 double-bit key, 3 mm	PS832029	4TBP832029C0100	1

#### M4 type keys



	Type	Order code	Pack
For security lock no. V2432E	PS832022	4TBP832022C0100	2
For security lock, 8mm square	PS832026	4TBP832026C0100	1
For security lock, 8mm triangular	PS832027	4TBP832027C0100	1
For security lock, 11 mm triangular	PS832072	4TBP832072C0100	1
For security lock, double-bit 3 mm	PS832028	4TBP832028C0100	1

#### Screws

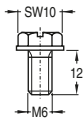

M6 flange screw

ACC811483 4TBC811483C0100 100

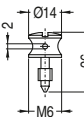

PVC M6 screw for cover plate (sealable)

ACC811451 4TBC811451R0100 100

#### Brackets

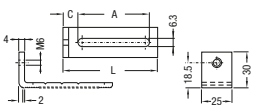

L	A	C	E	Type	Order code	Pack
40	24	9.5	-	ACC811478	4TBC811478R0300	100
80	64	9.5	-	ACC811479	4TBC811479R0300	100

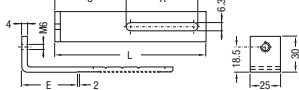

120 64 49.5 41.5 ACC811480 4TBC811480C0100 100

#### Aluminum profiles

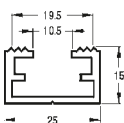

Profile length = 3 m

ACC811417 4TBC811417C0100 1







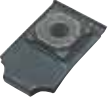

## General purpose enclosures

### Accessories - General Accessories

Galvanized profiles		Type	Order code	Pack
	C profile 15x8x1 Length: 3m	APACC890848	4TBO890848C0100	1
	DIN profile 35x7.3x1 Length: 3m	APACC890847	4TBO890847C0100	1
	C profile 30x15x1.5 Length: 3m	ACC811619	4TBC811619C0100	1
	Slide nuts for C profile 30 x 15 M6	ACC811363	4TBC811363C0100	25
	Slide nuts for C profile 25 x 10 M6	ACC811365	4TBC811365C0100	50
	Cu profile 12 x 5 with M5 tapped holes Length: 3m	ACC811263	4TBC811263C0100	1
	Jumpers + screws M5 x 13 Max. 2 x 10 mm <sup>2</sup> per jumper	APACC851123	4TBO851123C0100	10
Metal nuts		Type	Order code	Pack
	M6	ACC811435	4TBC811435C0100	100
	M4	ACC811438	4TBC811438C0100	100
	M6	ACC811446	4TBC811446C0100	100
	M8	ACC811447	4TBC811447C0100	100

## General purpose enclosures

### Accessories - General Accessories

Slide nuts	Type	Order code	Pack
	For perforated mounting plate		
	M4 bolt	AR831328	4TBA831328C0100 50
	M5 bolt	AR831329	4TBA831329C0100 50
	M6 bolt	AR831330	4TBA831330C0100 50
Rise pillars	Type	Order code	Pack
	For mounting on symmetrical DIN rail, height: 21 mm		
		ACC610312	4TBC610312C0100 10
Mounting equipment	Type	Order code	Pack
	Slide + M4 screw		
		APACC890835	4TBO890835C0100 10
	Slide + washer + M4 screw		
		APACC890836	4TBO890836C0100 10
	M5 screw for meter L = 21 mm		
		APACC890844	4TBO890844C0100 20
	M 4 x 8 screw		
		APACC890849	4TBO890849C0100 50
	M4 slider		
		APACC890841	4TBO890841C0100 50
	M4 washer		
		APACC890850	4TBO890850C0100 20
	Coupling set		
		APACC890840	4TBO890840C0100 20

## General purpose enclosures

### Accessories - General Accessories

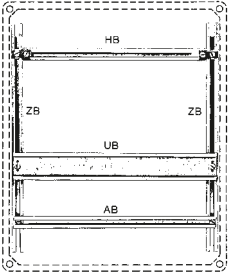
Profiles	Profile length	Enclosure width	Type	Order code	Pack
	<b>Type AB (C 15 x 8)</b>				
	100mm	150	APACC890809	4TBO890809C0100	10
	135mm	185	APACC890812	4TBO890812C0100	10
	250mm	300	APACC890817	4TBO890817C0100	10
	<b>Type UB<sup>(1)</sup></b>				
	90mm	150	APACC890810	4TBO890810C0100	10
	100mm	150	APACC890811	4TBO890811C0100	10
	135mm	185	APACC890814	4TBO890814C0100	10
	200mm	250	APACC890816	4TBO890816C0100	10
	250mm	300	APACC890820	4TBO890820C0100	10
	276mm	300	APACC890819	4TBO890819C0100	10
	320mm	370	APACC890824	4TBO890824C0100	10
	550mm	600	APACC890833	4TBO890833C0100	10
	<b>Type ZB (C 15 x 8)</b>				
	476mm	55	APACC890830	4TBO890830C0100	10

(1) DIN 46.277



# Pedestals



# Pedestals

## Index

<b>Pedestals</b>	
<b>EH</b>	
Cabinets for underground cable distribution and all types of outdoor industrial applications	130
<b>EH1-4</b>	
Overview insulated pedestals	131
<b>EH1</b>	
Small pedestal	132
<b>EH2</b>	
Column cabinets	133
<b>EH3</b>	
DIN size pedestals	136
<b>EH3</b>	
Accessories	141
<b>EH3</b>	
system parts	144
<b>EH3 / GD</b>	
DIN size pedestals deep version	148
<b>EH3 / GD</b>	
Accessories	150
<b>EH4</b>	
Column cabinets	151
<b>Pedestals</b>	
Dimensional	153
<b>Pedestals technical details</b>	
Power dissipation values	163

## Pedestals

EH - Cabinets for underground cable distribution and all types of outdoor industrial applications



A wide range of pedestals has completed our comprehensive range of nonmetallic enclosures for several years. In power distribution application pedestals enable the connection of underground cables and the distribution to several consumers within the cabinets. Besides there are lots of applications that require reliable outdoor housings like Telecommunication or Traffic signalling.

### Applications

- Energy distribution
- Cable television
- Telecommunication and electronics
- Traffic signalling and public lighting
- Temporary service for construction sites
- Camping sites and market places
- Marinas
- Water treatment
- Sub-stations
- 48 cm (19") racking systems

### Standard: EN / IEC 61439-5













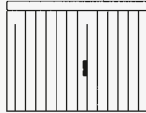



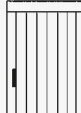
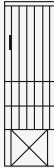



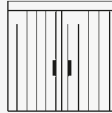

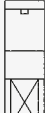
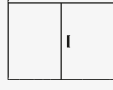
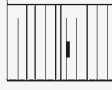
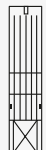



### Specifications

- Cabinets to be mounted on a plinth.
- The base is partly buried into the ground.
- For some types the base is an integrated part of the pedestals.
- As with all our polyester boxes and cabinets, the pedestal feature high protection and total insulation to IEC 61439-5.
- Degree of protection is at least IP43.
- Very high mechanical impact strength IK10 (EN/IEC 62262) and a high thermal insulation which results in reduced temperature variations within the enclosure.
- All cabinets are corrosion resistant and UV stabilised for outdoor applications.

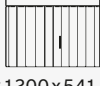

# Pedestals

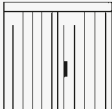
## EH1-4 - Overview insulated pedestals

<b>EH1</b> <b>IP43 / IP23</b>	<b>EH3 / F</b> <b>IP44</b>	<b>EH3 / AP</b> <b>IP44</b>	<b>EH3 / AP (continued)</b> <b>IP44</b>	<b>EH4</b> <b>IP43</b>
 753x385x270	 875x455x320 (DIN 00)	 875x455x320 (DIN 00)	 1125x1445x320 (DIN 3)	 1600x395x224
<b>EH2</b> <b>IP44</b>	 875x590x320 (DIN 0)	 875x590x320 (DIN 0)	 1310x785x320 (DIN 1)	 1600x495x224
 1097x433x240	 875x785x320 (DIN 1)	 875x785x320 (DIN 1)	 1125x1115x320 (DIN 2)	 1600x745x224
 1347x433x240	 875x1115x320 (DIN 2)	 875x1115x320 (DIN 2)	<b>EH3 / GD-AP</b> <b>IP44</b>	 1420x320x234
 1622x433x240	 875x1445x320 (DIN 3)	 875x1445x320 (DIN 3)	 875x676x541 / 676	 1850x320x234
 1896x433x240		 1125x455x320 (DIN 00)	 875x871x541 / 676	
		 1125x590x320 (DIN 0)	 875x1200x541 / 676	
		 1125x785x320 (DIN 1)	 1125x676x541 / 676	
		 1125x1115x320 (DIN 2)	 1125x871x541 / 676	
			 1125x1200x541 / 676	

HxD x W (mm)

## Pedestals

### EH1 - Small pedestal



EH1C14VH

#### Applications

- Cable television
- Gas distribution
- Telecommunication (surface connections)
- Camping sides

#### Standard: EN / IEC 62208

#### Specifications

- Small outdoor enclosure with integrated base.
- Hood grey colour RAL 7035:
  - ventilated version in polyester or thermoplastic engineering polymer,
  - non ventilated version in hot moulded, glass fibre reinforced polyester,
  - blackened triangular zamac locking screws, vandalproof and for all seasons.
- - Degrees of protection:
  - IP43 for the non ventilated hoods,
  - IP23 for the ventilated hoods.
- According to IEC 60529:
  - protection degree against external mechanical impacts according to EN/IEC 62262.
- IK09 polyester hood
- IK10 thermoplastic hood
- Rated insulation voltage Ui 690V
- Base in high density polyethylene (HDPE) RAL 9005
- Base resists a ground temperature of -50°C
- The upper part of the base serves as a mounting plate and is provided with three slots for fixation points.
- Moulded-in indication of burial depth.
- Option: 2432E lock.
- Easy to install by one person only (weight: 4.5 kg).
- Dimensions: 753×385×270 (H×W×D in mm)

#### EH1 - Column cabinet

Type	Type	Order code	Pack
(H x W x D) 753 x 385 x 270 mm			
Ventilated	EH1C14VHNA	4TBE841037C0100	1
Non-ventilated	EH1C14NH	4TBE841038C0100	1
<b>Accessories</b>			
The protective hood may be opened by an 8 mm triangular key.	PS832027	4TBP832027C0100	1
Ventilated protective hood	EH1AEEV3	4TBE841039N0100	1
Non-ventilated protective hood	EH1AEEN4	4TBE841040N0100	1
Closure for older models	EH1AEEEI	4TBE841041N0100	1

## Pedestals

### EH2 - Column cabinets



EH2 - Distribution columns

#### Applications

- Energy distribution
- Cable television
- Traffic signage and public lighting
- Camp sites and marketplaces
- Gas stations
- Pump applications

#### Standard: EN / IEC 61439-5

#### Specifications

- The lower section has a polyester plate closure.
- RAL 7035 dyed in the mass gray color.
- IP44 protection rating in accordance with EN/IEC 60529.
- Total insulation  $\square$ .
- IK10 protection rating against external mechanical impacts in accordance with EN/IEC 62262.
- Corrosion-resistant.
- UV-stable for exterior installation, improved UV resistance thanks to its special coating.
- Resistant to temperatures of between  $-35^{\circ}\text{C}$  and  $+80^{\circ}\text{C}$ .
- Temporary temperature increases cause no damage.
- The semi-cylindrical locks are built in to an integral handle, protected by a plastic anti-vandal cover.
- The front section comprises removable cases.
- The mounting holes for receiving M6 threaded inserts located on the rear panel allow direct access for installing sets of busbars, frames or mounting plates.
- The rear and base are made from a single piece.
- The lower section of the column provides a stable mounting into the ground
- The hinged hood has an opening angle of  $90^{\circ}$ , providing easy access.

## Pedestals

### EH2 - Column cabinets

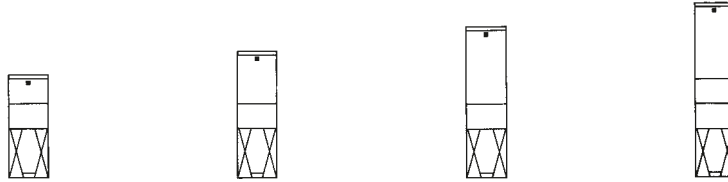

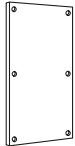

	Type	EH2-NA	EH2-NB	EH2-NC	EH2-ND	
Standard	H x W x D	1097x433x240	1347x433x240	1622x433x240	1896x433x240	
	Type	EH2C25CH	EH2C35CH	EH2C45CH	EH2C55CH	
	Order code	4TBE842072C0100	4TBE842073C0100	4TBE842074C0100	4TBE842075N0100	
Mounting plate	H x W x D	200x395x5	450x395x5	700x395x5	700x395x5	
	Pertinax with fixing bolts	Type	EH2M25EH	EH2M35EH	EH2M45EH	EH2M45EH
		Order code	4TBE842002C0100	4TBE842000C0100	4TBE842001C0100	4TBE842001C0100

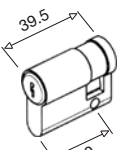

### EH2 - Accessories

Product	Type	Order code	Pack
<b>Locks - profile half cylinder type</b>			
	With 2 keys , V2432-E		
	EH3AEECI	4TBE843001C0100	1
	spare keys for EH3AEECI		
	PS832022	4TBP832022C0100	2
	With 1 square key, 8 mm		
	EH3AEEQHN	4TBE843002C0100	1
	With an 8mm triangular key		
	EH3AETHN	4TBE843003C0100	1
	With 2 keys A434		
	EH3UAECI	4TBE843248C0100	1
	Replacement keys upon request.		

Product	Type	Order code	Pack
<b>Inserts</b>			
	M6 x 11 threaded inserts		
	VJ890846	4TBO890846C0100	100
	Punch for inserting M6 threaded barrel		
	Support for cable release clamp (to be ordered separately)		
	APPL	4TBO852004C0100	1



# Pedestals

## EH3 - DIN size pedestals

Water and dust accumulation prevented by a sloped roof



Fixation of bus bars with M8 hexagonal screws in the side wall, to maximize the width and space for electrical devices ①. Fixation of mounting plate with M8 press-in nuts in the back wall to maximize depth for electrical devices ②.

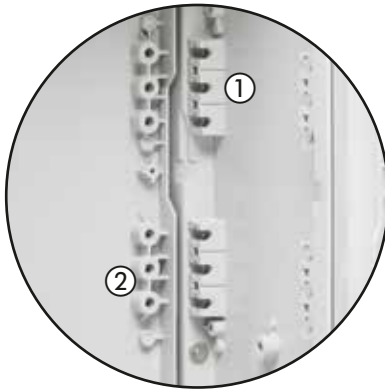

Convenient removal of bottom profile for easy access by tool less slider operation.

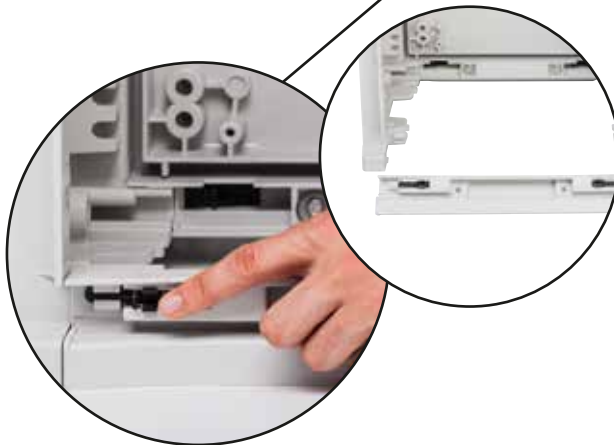

Easy fixation of side- /back-wall and roof by use of self tapping screws.





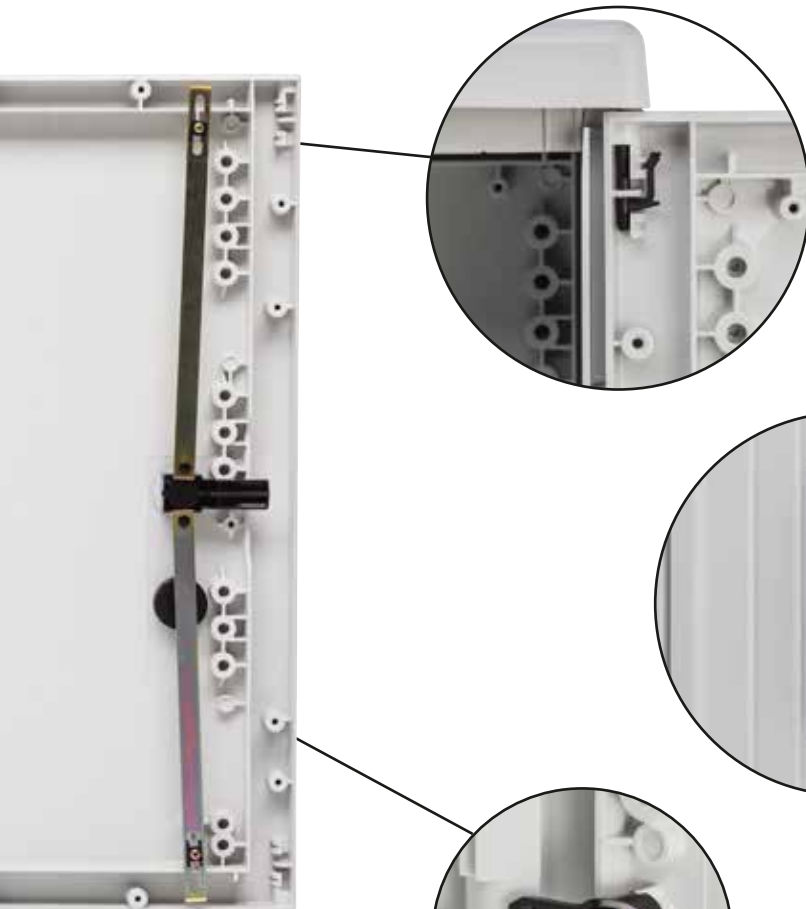

Quick and easy dis-assembly of door with captive hinge pins.



Swing handle for 45mm profile half cylinders with sealable cover.



Vandalism safe door. hook on doors inner side.



## Pedestals

### EH3 - DIN size pedestals



EH3 - DIN size pedestals

#### Applications

- Energy distribution
- Gray water processing
- Cable television
- Solar energy applications
- Camp sites and marketplaces
- Traffic signage and public lighting

#### Standard: EN / IEC 61439-5

#### Specifications

- Cabinets made of hot moulded, glass fibre reinforced polyester.
- Dyed in mass RAL 7035 light grey.
- Delivered in kit-form or factory assembled.
- Protection degree IP44 according to EN 60529, IEC 60529.
- Total insulation.
- Protection degree IK10 against external impacts according to EN/IEC 62262.
- Corrosion resistant.
- UV stabilized for outdoor applications, coated cabinets for increased resistance and aesthetics against UV-corrosion available.
- Suitable for use in environments from -35° C to +80° C. Temporary exceeding temperatures will not be harmful.
- The open door can be manually unhinged to allow free access for maintenance. Door opening angle exceeds 180°.
- Studs are moulded in the rear panel which can receive M8 inserts to allow direct mounting at busbars, a frame or a mounting plate for components.
- Fixation points at the side panel are foreseen to mount busbars.
- Supplied with open bottom.
- To be mounted on a basement according to DIN 43629 standard dimensions between the fixation points.
- The rainhood shape prevents water stagnation on the roof.
- Removable bottom profile for easy cable access without tools.

#### EH3/F - flat surface pedestals









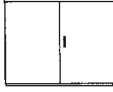

- 5 different widths; all sizes have the same height and depth.
- The swing handle is designed to receive a half profile cylindric lock.

#### EH3/AP - anti poster pedestals

- 5 sizes with 2 different height; all sizes have the same height and depth.
- 3-point closure system, exposed handle-actuated.
- The robust handle leaves more space inside the cabinet and is compatible with a profiled semi-cylindrical lock.
- The doors and rear panel are profiled, which prevents the affixing of posters.

## Pedestals

### EH3 - DIN size pedestals

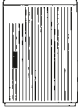
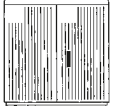
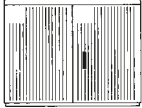
	DIN 00	DIN 0	DIN 1	DIN 2		
<b>Type EH3 / F (H=875) IP44</b>						
	<b>Type</b>	<b>EH3 / F - 00</b>	<b>EH3 / F - 0</b>	<b>EH3 / F - 1</b>	<b>EH3 / F - 2</b>	
	H x W x D	875x455x320	875x590x320	875x785x320	875x1115x320	
Factory-assembled	<b>Type</b>	EH3C8XC1	EH3C80S1	EH3C81S1	EH3C82S1	
	<b>Order code</b>	4TBE843670C0100	4TBE843158C0100	4TBE843160C0100	4TBE843162C0100	
<b>Type EH3 / AP (H=875) IP44</b>						
	<b>Type</b>	<b>EH3 / AP - 00</b>	<b>EH3 / AP - 0</b>	<b>EH3 / AP - 1</b>	<b>EH3 / AP - 2</b>	<b>EH3 / AP - 3</b>
	H x W x D	875x455x320	875x590x320	875x785x320	875x1115x320	875x1445x320
Factory-assembled	<b>Type</b>	EH3C8XC2	EH3C80S2	EH3C81S2	EH3C82S2	EH3C83S2
	<b>Order code</b>	4TBE843672C0100	4TBE843176C0100	4TBE843177C0100	4TBE843178C0100	4TBE843179C0100
Assembled, with UV coating	<b>Type</b>	EH3U8XC2	EH3U80S2	EH3C91S2	EH3C92S2	EH3C93S2
	<b>Order code</b>	4TBE843673N0100	4TBE843480C2100	4TBE843181C0100	4TBE843182C0100	4TBE843183C0100
<b>Type EH3 / AP (H=1125) IP44</b>						
	<b>Type</b>	<b>EH3 / AP - 200</b>	<b>EH3 / AP - 20</b>	<b>EH3 / AP - 21</b>	<b>EH3 / AP - 22</b>	<b>EH3 / AP - 23</b>
	H x W x D	1125x455x320	1125x590x320	1125x785x320	1125x1115x320	1125x1445x320
Factory-assembled	<b>Type</b>	EH3C9XC2	EH3C90S2	EH3C91S2	EH3C92S2	EH3C93S2
	<b>Order code</b>	4TBE843676C0100	4TBE843180C0100	4TBE843181C0100	4TBE843182C0100	4TBE843183C0100
Assembled, with UV coating	<b>Type</b>	EH3U9XC2	EH3U90S2	EH3U91S2	EH3U92S2	EH3U93S2
	<b>Order code</b>	4TBE843677N0100	4TBE843484N2100	4TBE843485N2100	4TBE843486N2100	4TBE843487C2100
Assembled, with UV and anti-graffiti coating	<b>Type</b>	EHP3200DAG	EHP320DAG	EHP321DAG	EHP322DAG	EHP323DAG
	<b>Order code</b>	4TBE843731C0100	4TBE843732C0100	4TBE843733C0100	4TBE843734C0100	4TBE843735C0100

## Pedestals

### EH3 - DIN size pedestals

#### EH3 / DC - DIN 2 Pedestals with separate compartments

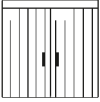
Product		Type	Order code	Pack
	EH3 / DC - 2	H x D x W		
	Assembled with 2 double-closure handles	1125x1115x320	EH3C92D2	4TBE843576C0100
	Pertinax mounting plate with mounting bolts	915 x 445 x 5	EH3A95P5	4TBE843728C0100
		915 x 445 x 10	EH3A95P10	4TBE843729C0100
2 mounting plates are required per cabinet				

#### EH3 DIN1 pedestals - Height 1310 mm

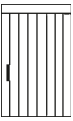
Product		Type	Order code	Pack
	EH3 / AP 31 - DIN 1	H x D x W		
	Reactivate	1310x785x320	EH3C61C2	4TBE843689C0100
	Assembled with double-locking handle	1310x785x320	EH3C61D2	4TBE843692C0100
	Pertinax mounting plate with mounting bolts	1100x680x5	EH3M61EH	4TBE843693C0100

## Pedestals

### EH3 - Accessories

#### DIN bases

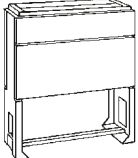
		DIN 00	DIN 0	DIN 1	DIN 2	DIN 3	
	HxWxD	900x450x310	900x585x310	900x780x310	900x1110x310	900x1430x310	
	Factory-assembled	<b>Type</b>	EH3BEXEH	EH3BE0EH	EH3BE1EH	EH3BE2EH	-
		<b>Order code</b>	4TBE843390N0100	4TBE843391N0100	4TBE843392N0100	4TBE843393C0100	
	Polyester base, supplied in kit form, RAL 7035	<b>Type</b>	EH3SEXEI	EH3SE0EI	EH3SE1EI	EH3SE2EI	EH3SE3EI
		<b>Order code</b>	4TBE843204R0100	4TBE843205R0100	4TBE843206R0100	4TBE843207R0100	4TBE843208R0100
	Base made from recycled material Construction kit, Color similar to RAL 7035	<b>Type</b>	EH3SEXEH	EH3SE0EH	EH3SE1EH	EH3SE2EH	EH3SE3EH
	<b>Order code</b>	4TBE842098R0100	4TBE842099R0100	4TBE842100R0100	4TBE842101R0100	4TBE843144R0100	

#### Mounting plates

		HxWxD	665x350x5	665x485x5	665x680x5	705x1000x5	705x1340x5
	Pertinax mounting plate	<b>Type</b>	EH3M8XEH	EH3M80EH	EH3M81EH	EH3M82EH	EH3M83EI
		<b>Order code</b>	4TBE843681C0100	4TBE843024C0100	4TBE843044C0100	4TBE843057C0100	4TBE843067C0100
		HxWxD	915x350x5	915x485x5	915x680x5	955x1000x5	955x1340x5
Height 1125mm		<b>Type</b>	EH3M9XEH	EH3M90EH	EH3M91EH	EH3M92EH	EH3M93EI
		<b>Order code</b>	4TBE843682C0100	4TBE843070C0100	4TBE843071C0100	4TBE843072C0100	4TBE843256C0100
		HxWxD	915x680x10	-	915x680x10	955x1000x10	955x1340x10
	<b>Type</b>	-	-	EH3M91EHP	EH3M92EHP	EH3M93EH	
	<b>Order code</b>			4TBE783325C0100	4TBE783326C0100	4TBE783327C0100	



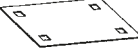



#### Base plates

		HxWxD	427x285x3	562x285x3	757x285x3	1086x285x3	1416x285x3
	Base plate 3 mm polyester with securing screws	<b>Type</b>	EH3PEXEI	EH3PE0EH	EH3PE1EH	EH3PE2EH	EH3PE3EH
		<b>Order code</b>	4TBE843683C0100	4TBE843300C0100	4TBE843301C0100	4TBE843302C0100	4TBE843303C0100

## Pedestals

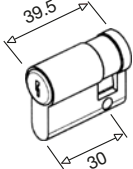
### EH3 - Accessories

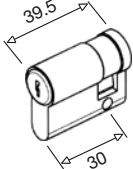
#### EH3 - Accessories

Product	Type	Order code	Pack
<b>Locks with profile half cylinder</b>			
	 With 2 keys , V2432-E	EH3AEECI 4TBE843001C0100	1
	Spare keys for EH3AEECI	PS832022 4TBP832022C0100	2
	 With 1 square key, 8 mm	EH3AEEQH 4TBE843002C0100	1
	 With an 8 mm triangular key	EH3AEETH 4TBE843003C0100	1
	 With 2 keys A434	EH3UAECI 4TBE843248C0100	1
	Spare keys upon request.		

#### Diagram holder

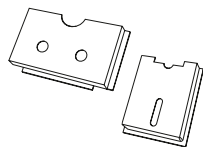

DIN A4 - W x H = 325 x 180 mm		
AR811516 4TBX811516R0100	1	
DIN A5 - W x H= 155 x 225 mm		
PS832000 4TBP832000C0100	1	

#### IP44 ventilation grille



Set of 2 pieces		
PS832019 4TBP832019C0100	1	
Suitable for a ventilation opening Includes 2 grilles and 4 nylon nails. Total insulation. RAL 7035		

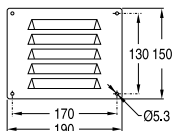

#### Threaded insert





M8 threaded insert Dodge-type for rear wall and door.		
APTIM4 4TBO851026C0100	100	

Product	Type	Order code	Pack
<b>Handle</b>			
	Handle for lock with a profile half cylinder	EH3EEESH 4TBE843000C0100	1
	Spare part		
<b>Double closure handle</b>			
	For two locks with profile half cylinder	EH3AEEDH 4TBE783042C0100	1
	Spare part (Note: for after-market installation, an operation is required on the door mechanism).		

## Pedestals

### EH3 - Accessories

#### EH3 - Accessories

Product	Type	Order code	Pack
<b>Front plate with opening for temporary connections on DIN base</b>			
May be used with DIN -00 to -2 bases in RAL 7035 color (EH3SEXEI-EH3SE2EI). This front plate is not standard and must be ordered in addition. The standard closed front plate may be used if it is not necessary for temporary connections. The DIN 3 base is standard with a front plate for temporary connections. The front plates on the front and rear are secured by screws.			
	For DIN 0 base - EH3SE0EI - 1 opening	EH3TE0EE	4TBE843713R0100 1
	For DIN 1 base - EH3SE1EI - 1 opening	EH3TE1EE	4TBE843714R0100 1
	For DIN 2 base - EH3SE2EI - 2 openings	EH3TE2EE	4TBE843715R0100 1
	Standard DIN 3 base with a front plate for temporary connections. The front plates on the front and rear are secured by screws.	EH3TE3EE	4TBE843716R0100 1

Product	Type	Order code	Pack
<b>Door locking</b>			
	May be installed on left-hand or right-hand swinging doors. Mounting by drilling 2 holes in the interior profile. Includes mounting parts.	EH3AEEEZ	4TBE843007C0100 1

<b>Screws (replacement parts)</b>			
	Clip-in button Hilo 5.8 x 16 mm	EH3AEEEN	4TBE843556C0100 1
	Clip-in button Hilo 5.8 x 22 mm	EH3OE EEG	4TBE890278C0100 1

<b>Mounting bolts for mounting plates (replacement parts)</b>			
	DIN 00-0-1	EH3AE0EI	4TBE843566C0100 1
	DIN 2-3	EH3AE2EI	4TBE843567C0100 1

## Pedestals

### EH3 - system parts

#### EH3 / F (H = 875)

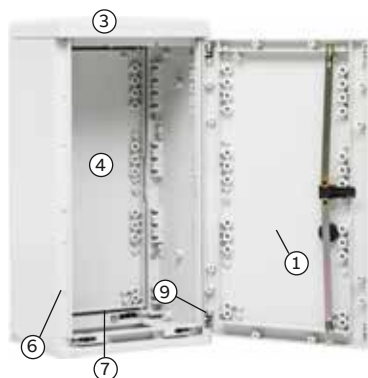

Type		DIN 00	
EH3 / F (H=875)		EH3 / F - 00	
		left-hand	right-hand
① Door (with handle)	Type		EH3A8XC1
	Order code		4TBE843639N0100
② Door stop	Type	-	-
	Order code		
③ Hood	Type	EH3AEXE5	EH3AEXE5
	Order code	4TBE843634C0100	4TBE843634C0100
④ Rear wall (you will require 2 for DIN2 and DIN3)	Type	EH3A8XE7	EH3A8XE7
	Order code	4TBE843636C0100	4TBE843636C0100
⑤ Center cross member	Type	-	-
	Order code		
⑥ Side panel	Type	EH3A8EEN	EH3A8EEM
	Order code	4TBE843592C0100	4TBE843591C0100
⑦ Base profile	Type	EH3AEXEC	EH3AEXEC
	Order code	4TBE843514C0100	4TBE843514C0100
⑧ Cross member	Type	-	-
	Order code		
⑨ Set of hinges (you will require 2 for DIN2 and DIN3)	Type	EH3AEEEL	EH3AEEEL
	Order code	4TBE843445C0100	4TBE843445C0100
⑩ Set of accessories	Type	EH3AE0EG	EH3AE0EG
	Order code	4TBE843447N0100	4TBE843447N0100

Type		DIN 00	
EH3 / AP (H=875)		left-hand	right-hand
① Door (with handle)	Type		EH3A8XC2
	Order code		4TBE843640C0100
② Door stop	Type	-	-
	Order code		
③ Hood	Type	EH3AEXE5	EH3AEXE5
	Order code	4TBE843634C0100	4TBE843634C0100
④ Rear wall (you will require 2 for DIN2 and DIN3)	Type	EH3A8XE8	EH3A8XE8
	Order code	4TBE843637C0100	4TBE843637C0100
⑤ Center cross member	Type	-	-
	Order code		
⑥ Side panel	Type	EH3A8EEN	EH3A8EEM
	Order code	4TBE843592C0100	4TBE843591C0100
⑦ Base profile	Type	EH3AEXEC	EH3AEXEC
	Order code	4TBE843514C0100	4TBE843514C0100
⑧ Cross member	Type	-	-
	Order code		
⑨ Set of hinges (you will require 2 for DIN2 and DIN3)	Type	EH3AEEEL	EH3AEEEL
	Order code	4TBE843445C0100	4TBE843445C0100
⑩ Set of accessories	Type	EH3AE0EG	EH3AE0EG
	Order code	4TBE843447N0100	4TBE843447N0100

For polyester parts with anti-erosion UV coating, please contact us.

- ① Door (with handle)
- ② Door stop
- ③ Hood
- ④ Rear wall
- ⑤ Center cross member

- ⑥ Side panel
- ⑦ Base profile
- ⑧ Cross member
- ⑨ Set of hinges
- ⑩ The set of accessories includes bolts, washers and nuts for polyester cabinet assembly.



## Pedestals

### EH3 - system parts

DIN 0		DIN 1		DIN 2	
EH3 / F - 0		EH3 / F - 1		EH3 / F - 2	
left-hand	right-hand	left-hand	right-hand	left-hand	right-hand
	EH3A80E1		EH3A81SH	EH3A82EM	EH3A82CA
	4TBE843035N0100		4TBE843049N0100	4TBE843615C0100	4TBE843614C0100
-	-	-	-	EH3A8EER	EH3A8EER
				4TBE843605C0100	4TBE843605C0100
EH3AE0EJ	EH3AE0EJ	EH3AE1EH	EH3AE1EH	EH3AE2EJ	EH3AE2EJ
4TBE843599C0100	4TBE843599C0100	4TBE843600C0100	4TBE843600C0100	4TBE843601C0100	4TBE843601C0100
EH3A80EI	EH3A80EI	EH3A81EF	EH3A81EF	EH3A82EF	EH3A82EF
4TBE843519C0100	4TBE843519C0100	4TBE843521C0100	4TBE843521C0100	4TBE843607C0100	4TBE843607C0100
-	-	-	-	EH3A8EEQ	EH3A8EEQ
				4TBE843603C0100	4TBE843603C0100
EH3A8EEN	EH3A8EEM	EH3A8EEN	EH3A8EEM	EH3A8EEN	EH3A8EEM
4TBE843592C0100	4TBE843591C0100	4TBE843592C0100	4TBE843591C0100	4TBE843592C0100	4TBE843591C0100
EH3AE0EH	EH3AE0EH	EH3AE1EC	EH3AE1EC	EH3AE2EH	EH3AE2EH
4TBE843515C0100	4TBE843515C0100	4TBE843516C0100	4TBE843516C0100	4TBE843517C0100	4TBE843517C0100
-	-	-	-	-	-
EH3AEEEL	EH3AEEEL	EH3AEEEL	EH3AEEEL	EH3AEEEL	EH3AEEEL
4TBE843445C0100	4TBE843445C0100	4TBE843445C0100	4TBE843445C0100	4TBE843445C0100	4TBE843445C0100
EH3AE0EG	EH3AE0EG	EH3AE0EG	EH3AE0EG	EH3AE2EG	EH3AE2EG
4TBE843447N0100	4TBE843447N0100	4TBE843447N0100	4TBE843447N0100	4TBE843452C0100	4TBE843452C0100

DIN 0		DIN 1		DIN 2		DIN 3	
EH3 / AP - 0		EH3 / AP - 1		EH3 / AP - 2		EH3 / AP - 3	
left-hand	right-hand	left-hand	right-hand	left-hand	right-hand	left-hand	right-hand
	EH3A80S2		EH3A81S2	EH3A82C2	EH3A82S2	EH3A83CA	EH3A83SH
	4TBE843101C0100		4TBE843104C0100	4TBE843538N0100	4TBE843108C0100	4TBE843542N0100	4TBE843369C0100
-	-	-	-	EH3A8EER	EH3A8EER	EH3A8EER	EH3A8EER
				4TBE843605C0100	4TBE843605C0100	4TBE843605C0100	4TBE843605C0100
EH3AE0EJ	EH3AE0EJ	EH3AE1EH	EH3AE1EH	EH3AE2EJ	EH3AE2EJ	EH3AE3EJ	EH3AE3EJ
4TBE843599C0100	4TBE843599C0100	4TBE843600C0100	4TBE843600C0100	4TBE843601C0100	4TBE843601C0100	4TBE843602C0100	4TBE843602C0100
EH3A83EA	EH3A83EA	EH3A81EA	EH3A81EA	EH3A82EL	EH3A82EL	EH3A83EL	EH3A83EL
4TBE843531C0100	4TBE843531C0100	4TBE843533C0100	4TBE843533C0100	4TBE843609C0100	4TBE843609C0100	4TBE843610C0100	4TBE843610C0100
-	-	-	-	EH3A8EEQ	EH3A8EEQ	EH3A8EEQ	EH3A8EEQ
				4TBE843603C0100	4TBE843603C0100	4TBE843603C0100	4TBE843603C0100
EH3A8EEN	EH3A8EEM	EH3A8EEN	EH3A8EEM	EH3A8EEN	EH3A8EEM	EH3A8EEN	EH3A8EEM
4TBE843592C0100	4TBE843591C0100	4TBE843592C0100	4TBE843591C0100	4TBE843592C0100	4TBE843591C0100	4TBE843592C0100	4TBE843591C0100
EH3AE0EH	EH3AE0EH	EH3AE1EC	EH3AE1EC	EH3AE2EH	EH3AE2EH	EH3AE3EI	EH3AE3EI
4TBE843515C0100	4TBE843515C0100	4TBE843516C0100	4TBE843516C0100	4TBE843517C0100	4TBE843517C0100	4TBE843518C0100	4TBE843518C0100
-	-	-	-	-	-	-	-
EH3AEEEL	EH3AEEEL	EH3AEEEL	EH3AEEEL	EH3AEEEL	EH3AEEEL	EH3AEEEL	EH3AEEEL
4TBE843445C0100	4TBE843445C0100	4TBE843445C0100	4TBE843445C0100	4TBE843445C0100	4TBE843445C0100	4TBE843445C0100	4TBE843445C0100
EH3AE0EG	EH3AE0EG	EH3AE0EG	EH3AE0EG	EH3AE2EG	EH3AE2EG	EH3AE2EG	EH3AE2EG
4TBE843447N0100	4TBE843447N0100	4TBE843447N0100	4TBE843447N0100	4TBE843452C0100	4TBE843452C0100	4TBE843452C0100	4TBE843452C0100

## Pedestals

### EH3 - system parts

#### EH3 / AP (H = 1125)

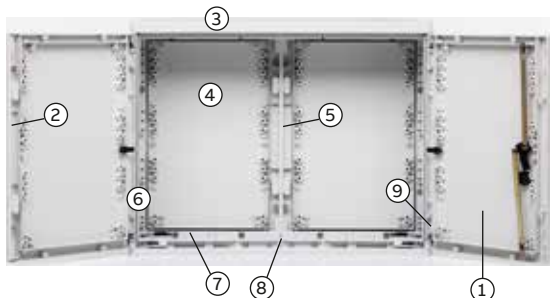

Type	DIN 00	
	left-hand	right-hand
<b>EH3 / AP (H = 1125)</b>		
① Door (with handle)	Type	EH3A9XC2
	Order code	4TBE843641C0100
② Door stop	Type	-
	Order code	-
③ Hood	Type	EH3AEXE5
	Order code	4TBE843634C0100
④ Rear wall (you will require 2 for DIN2 and DIN3)	Type	EH3A9XE8
	Order code	4TBE843638C0100
⑤ Center cross member	Type	-
	Order code	-
⑥ Side panel	Type	EH3A9EEM
	Order code	4TBE843594C0100
⑦ Base profile	Type	EH3AEXEC
	Order code	4TBE843514C0100
⑧ Cross member	Type	-
	Order code	-
⑨ Set of hinges (you will require 2 for DIN2 and DIN3)	Type	EH3AEEEL
	Order code	4TBE843445C0100
⑩ Set of accessories	Type	EH3AE0EG
	Order code	4TBE843447N0100

Note: Set of accessories including bolts, washers and nuts for mounting separate parts inside the cabinet.

- ① Door (with handle)
- ② Door stop
- ③ Hood
- ④ Rear wall
- ⑤ Center cross member

- ⑥ Side panel
- ⑦ Base profile
- ⑧ Cross member
- ⑨ Set of hinges
- ⑩ The set of accessories includes bolts, washers and nuts for polyester cabinet assembly.

## Pedestals

### EH3 - system parts

DIN 0		DIN 1		DIN 2		DIN 3	
EH3 / AP - 20		EH3 / AP - 21		EH3 / AP - 22		EH3 / AP - 23	
left-hand	right-hand	left-hand	right-hand	left-hand	right-hand	left-hand	right-hand
	EH3A90S1		EH3A91S1	EH3A92EJ	EH3A92CA	EH3A93EL	EH3A93CA
	4TBE843117N0100		4TBE843120C0100	4TBE843627C0100	4TBE843626C0100	4TBE843630C0100	4TBE843629C0100
-	-	-	-	EH3A9EEQ	EH3A9EEQ	EH3A9EEQ	EH3A9EEQ
				4TBE843606C0100	4TBE843606C0100	4TBE843606C0100	4TBE843606C0100
EH3AE0EJ	EH3AE0EJ	EH3AE1EH	EH3AE1EH	EH3AE2EJ	EH3AE2EJ	EH3AE3EJ	EH3AE3EJ
4TBE843599C0100	4TBE843599C0100	4TBE843600C0100	4TBE843600C0100	4TBE843601C0100	4TBE843601C0100	4TBE843602C0100	4TBE843602C0100
EH3A90E8	EH3A90E8	EH3A91EA	EH3A91EA	EH3A92EA	EH3A92EA	EH3A93EK	EH3A93EK
4TBE843543C0100	4TBE843543C0100	4TBE843545C0100	4TBE843545C0100	4TBE843611C0100	4TBE843611C0100	4TBE843612C0100	4TBE843612C0100
-	-	-	-	EH3A9EEP	EH3A9EEP	EH3A9EEP	EH3A9EEP
				4TBE843604C0100	4TBE843604C0100	4TBE843604C0100	4TBE843604C0100
EH3A9EEM	EH3A9EEL	EH3A9EEM	EH3A9EEL	EH3A9EEM	EH3A9EEL	EH3A9EEM	EH3A9EEL
4TBE843594C0100	4TBE843593C0100	4TBE843594C0100	4TBE843593C0100	4TBE843594C0100	4TBE843593C0100	4TBE843594C0100	4TBE843593C0100
EH3AE0EH	EH3AE0EH	EH3AE1EC	EH3AE1EC	EH3AE2EH	EH3AE2EH	EH3AE3EI	EH3AE3EI
4TBE843515C0100	4TBE843515C0100	4TBE843516C0100	4TBE843516C0100	4TBE843517C0100	4TBE843517C0100	4TBE843518C0100	4TBE843518C0100
-	-	-	-	EH3AEES	EH3AEES	EH3AEES	EH3AEES
				4TBE843631C0100	4TBE843631C0100	4TBE843631C0100	4TBE843631C0100
EH3AEEL	EH3AEEL	EH3AEEL	EH3AEEL	EH3AEEL	EH3AEEL	EH3AEEL	EH3AEEL
4TBE843445C0100	4TBE843445C0100	4TBE843445C0100	4TBE843445C0100	4TBE843445C0100	4TBE843445C0100	4TBE843445C0100	4TBE843445C0100
EH3AE0EG	EH3AE0EG	EH3AE0EG	EH3AE0EG	EH3AE2EG	EH3AE2EG	EH3AE2EG	EH3AE2EG
4TBE843447N0100	4TBE843447N0100	4TBE843447N0100	4TBE843447N0100	4TBE843452C0100	4TBE843452C0100	4TBE843452C0100	4TBE843452C0100

## Pedestals

EH3 / GD - DIN size pedestals deep version



EH3 GD deep cabinets

### Applications

- Energy distribution
- Gas meter cabinet
- Control cabinet and
- Generators and transformer stations
- Pump house installation
- Cabinet for 19" power supply frame
- Rectifiers

### Standard: EN / IEC 61439-5

### Specifications and advantages

- Doors, back and side walls made from hot molded glass fiber-reinforced polyester.
- RAL 7035 dyed in the mass gray color.
- Glass fiber-reinforced hand lay-up polyester hood.
- Hood with RAL 7035 outer coating.
- Twelve sizes in two heights, two depths and three widths.  
Cabinets supplied assembled.
- Supplied factory-assembled or in kit form.
- IP44 protection rating in accordance with EN/IEC 60529.
- Total insulation  $\square$ .
- IK10 protection rating against external mechanical impacts in accordance with EN/IEC 62262.
- Corrosion-resistant.
- UV-stable for outdoors installation.
- Resistant to temperatures of between -35 C and +80 C.





Temporary temperature increases cause no damage.

- This handle is not flush-fitting, increases the usable depth of the cabinet and can be fitted with semi-cylindrical locks.
- Doors can be removed manually for ease of access for maintenance tasks.
- Option to have the door side-opening or bottom-opening.
- The mounting holes for receiving M8 threaded inserts located on the rear panel allow direct access for installing sets of busbars, frames or mounting plates.
- Option to have the door side-opening or bottom-opening.
- Supplied with mounting points for installation on the ground or on a base.
- The shape of the hood prevents standing water which could stagnate.
- The anti-poster surfaces make it very difficult to affix posters and result in them falling away.

## Pedestals

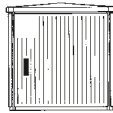
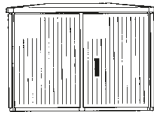
### EH3 / GD - DIN size pedestals deep version

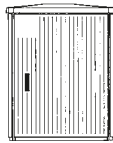
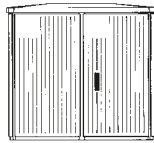

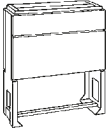



#### EH3 / GD - DIN size pedestals deep version

	Width	676	871	1200	
<b>Type EH3 / GD</b> <b>Height 875 mm</b> <b>IP44 assembled cabinet</b>					
		<b>Type</b>	<b>EH3 / GD-AP - 031</b>	<b>EH3 / GD-AP - 041</b>	<b>EH3 / GD-AP - 051</b>
		<b>HxWxD</b>	875x676x541	875x871x541	875x1200x541
Depth 541 mm	<b>Type</b>	EH3G86C2	EH3G87C2	EH3G88C2	
	<b>Order code</b>	4TBE843645C0100	4TBE843646C0100	4TBE843647N0100	
<b>Type EH3 / GD</b> <b>Height 1125 mm</b> <b>IP44 assembled cabinet</b>					
		<b>Type</b>	<b>EH3 / GD-AP - 233</b>	<b>EH3 / GD-AP - 243</b>	<b>EH3 / GD-AP - 253</b>
		<b>HxWxD</b>	1125x676x541	1125x871x541	1125x1200x541
Depth 541 mm	<b>Type</b>	EH3G96C2	EH3G97C2	EH3G98C2	
	<b>Order code</b>	4TBE843651C0100	4TBE843652C0100	4TBE843653C0100	
	<b>HxWxD</b>	1125x676x676	1125x871x676	1125x1200x676	
Depth 676 mm	<b>Type</b>	EH3G96CA	EH3G97CA	EH3G98CA	
	<b>Order code</b>	4TBE843654C0100	4TBE843655C0100	4TBE843656C0100	
	<b>Mounting plate</b>	<b>HxWxD</b>	665x485x5	665x680x5	705x1000x5
	Height = 875 mm	<b>Type</b>	EH3M80EH	EH3M81EH	EH3M82EH
		<b>Order code</b>	4TBE843024C0100	4TBE843044C0100	4TBE843057C0100
		<b>HxWxD</b>	915x485x5	915x680x5	915x1000x5
	Height = 1125 mm	<b>Type</b>	EH3M90EH	EH3M91EH	EH3M92EH
		<b>Order code</b>	4TBE843070C0100	4TBE843071C0100	4TBE843072C0100
	<b>HxWxD</b>		915x680x10	915x1000x10	
Pertinax with securing screws	<b>Type</b>		EH3M91EHP	EH3M92EHP	
	<b>Order code</b>		4TBE783325C0100	4TBE783326C0100	
	<b>Base plate</b>	<b>HxWxD</b>	676 x 541	871 x 541	1200 x 541
	Depth = 541 mm	<b>Type</b>	EH3PE6EH	EH3PE7EH	EH3PE8EH
		<b>Order code</b>	4TBE843657C0100	4TBE843658C0100	4TBE843659C0100
		<b>HxWxD</b>	676 x 676	871 x 676	1200 x 676
	Depth = 676 mm	<b>Type</b>	EH3PE6EI	EH3PE7EI	EH3PE8EI
		<b>Order code</b>	4TBE843660C0100	4TBE843661C0100	4TBE843662C0100
3mm polyester with securing screws					
	<b>Polyester base - Supplied in kit form for cabinets</b>	<b>HxWxD</b>	900x676x541	900x871x541	900x1200x541
	Depth = 541 mm	<b>Type</b>	EH3BE6EH	EH3BE7EH	EH3BE8EH
		<b>Order code</b>	4TBE843663C0100	4TBE843664C0100	4TBE843665C0100
		<b>HxWxD</b>	900x676x676	900x871x676	900x1200x676
	Depth = 676 mm	<b>Type</b>	EH3BE6EI	EH3BE7EI	EH3BE8EI
		<b>Order code</b>	4TBE843666C0100	4TBE843667C0100	4TBE843668C0100

## Pedestals

### EH3 / GD - Accessories

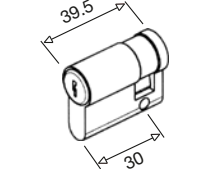
#### EH3 - Accessories

Product	Type	Order code	Pack
<b>Locks with profile half cylinder</b>			
	 With 2 keys , V2432-E	EH3AEECI 4TBE843001C0100	1
	Spare keys for EH3AEECI	PS832022 4TBP832022C0100	2
	 With 1 square key, 8 mm	EH3AEEQH 4TBE843002C0100	1
 With an 8 mm triangular key	EH3AEETH 4TBE843003C0100	1	
	 With 2 keys A434	EH3UAECI 4TBE843248C0100	1
	Spare keys upon request.		

#### Diagram holder

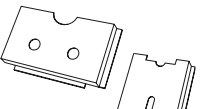

	DIN A4 - W x H = 325x180 mm	AC811516 4TBC811516C0100	1
	DIN A5 - W x H= 155x225 mm	PS832000 4TBP832000C0100	1

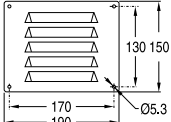
#### IP44 ventilation grille

	Set of 2 pieces	PS832019 4TBP832019C0100	1
	Suitable for a ventilation opening Includes 2 grilles and 4 nylon nails. Total insulation. RAL 7035		
			

#### Threaded insert

	M8 threaded insert Dodge-type for rear wall and door.	APTIM4 4TBO851026C0100	100
---	--	------------------------	-----

Product	Type	Order code	Pack
<b>Handle</b>			
	Handle for lock with a profile half cylinder	EH3EEESH 4TBE843000C0100	1
	Spare part		
<b>Double closure handle</b>			
	For two locks with profile half cylinder	EH3AEEDH 4TBE783042C0100	1
	Spare part (Note: for after-market installation, an operation is required on the door mechanism).		

## Pedestals

### EH4 - Column cabinets



EH4 Column Cabinets

#### Applications

- Energy distribution
- Cable television
- Traffic signaling
- Camp sites
- Gas stations

#### Standard: EN / IEC 61439-5

#### Specifications

- Doors, back and side walls made from hot molded glass fiber-reinforced polyester.
- RAL 7035 dyed in the mass gray color.
- IP44 protection rating in accordance with EN/IEC 60529.
- Total insulation  $\square$ .
- IK10 protection rating against external mechanical impacts in accordance with EN/IEC 62262.
- Corrosion-resistant.
- UV-stable for outdoors installation.
- Resistant to temperatures of between -35 C and +80 C, temporary temperature increases cause no damage.
- The mounting holes for receiving M6 threaded inserts located on the rear panel allow direct access for installing sets of busbars, frames or mounting plates.
- The lower section of the column provides a stable mounting into the ground
- The shape of the hood prevents standing water which could stagnate.

#### EH4

- Cabinet with hinged door - IP44.
- The column and lower section are supplied together.
- Supplied with handle for semi-cylindrical lock.
- Door opening angle of 180°.

#### EH4-S

- Cabinet with removable front components - IP44.
- The lower and rear sections of the column are molded as a single piece.
- The front of the column has a recessed housing for a cylindrical lock, protected by a plastic anti-vandalism cover.
- Easy to access thanks to removable front panels.

## Pedestals

### EH4 - Column cabinets

#### EH4/ EH4S - Distribution columns

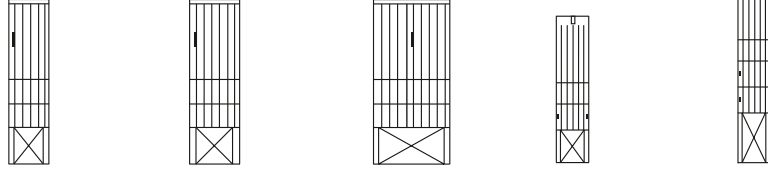

Width	395	495	745	320	320
Type	EH4-00	EH4-0	EH4-1	EH4-S1	EH4-S2
HxWxD	1600 x 395 x 224	1600 x 495 x 224	1600 x 745 x 224	1420 x 320 x 234	1850 x 320 x 234
Type	EH4CAECH	EH4CAECI	EH4CAEL	EH4CB9CH	EH4CC9CH
Order code	4TBE844130R0100	4TBE844131R0100	4TBW844132C0100	4TBE844153R0100	4TBE844185R0100



Pertinax mounting plate with securing screws

HxWxD	790 x 370 x 5	790 x 470 x 5	790 x 720 x 5	600 x 278 x 5	950 x 278 x 5
Type	EH4MEXEH	EH4ME0EH	EH4ME1EH	EH4MB9EH	EH4MC9EH
Order code	4TBE844133C0100	4TBE844134C0100	4TBE844135N0100	4TBE844154R0100	4TBE844186R0100

#### Accessories

Product	Type	Order code	Pack	
<b>Locks with profile half cylinder</b>				
		For EH4 - security lock V2432E		
	ⓘ	PS832030	4TBP832030C0100	1
		Spare keys for PS832030		
		PS832741	4TBP832741R0100	2
		For EH4 - security lock V2432E with double closure		
	ⓘ	PS832331	4TBE832331R0100	1
	For EH4-S - with 2 keys, V2432-E			
ⓘ	EH3AEECI	4TBE841001C0100	1	
	Spare keys for 843001			
	PS832022	4TBP832022C0100	1	
	Spare keys upon request.			

Product	Type	Order code	Pack
<b>Double closure handle</b>			
		For two locks with profile half cylinder	
		EH4AEEDH	4TBE844152R0100
	Spare part (Note: for after-market installation, an operation is required on the door mechanism).		



---

## Pedestals

### EH1 - Small pedestal - Dimensional drawings

#### EH1 - Small pedestal

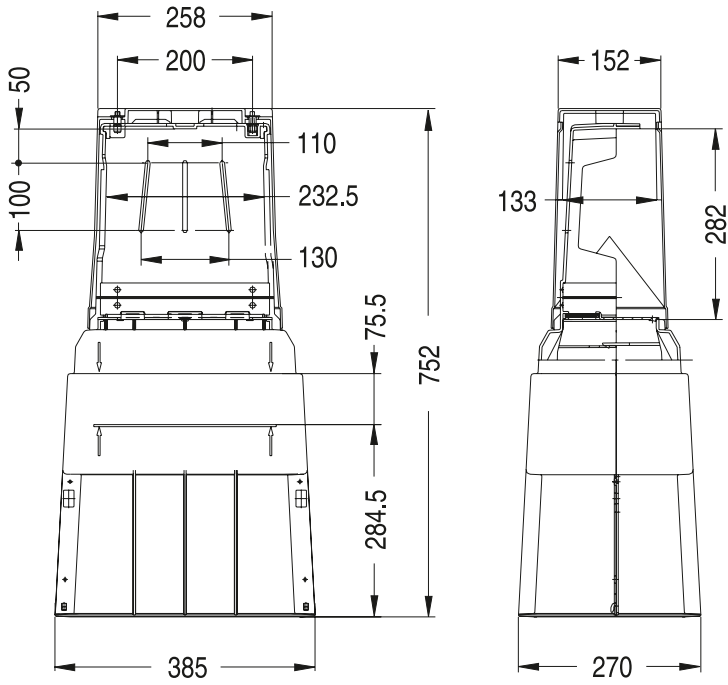

# Pedestals

## EH2 - Dimensional drawings

### EH2 - Column cabinets

#### EH2-NA

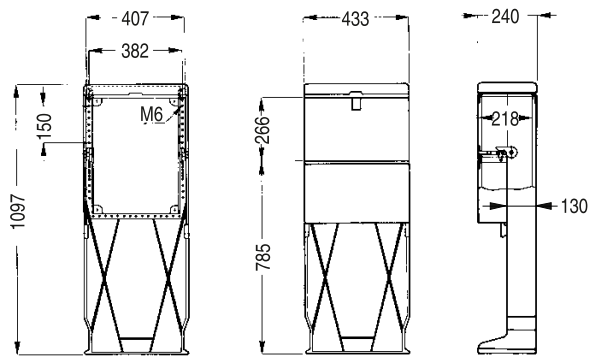

#### EH2-NB

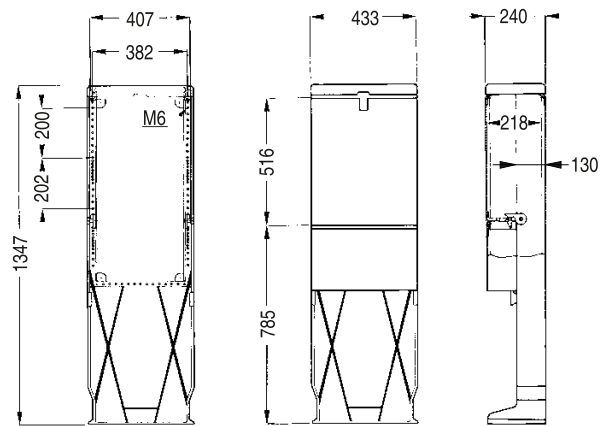

#### EH2-NC

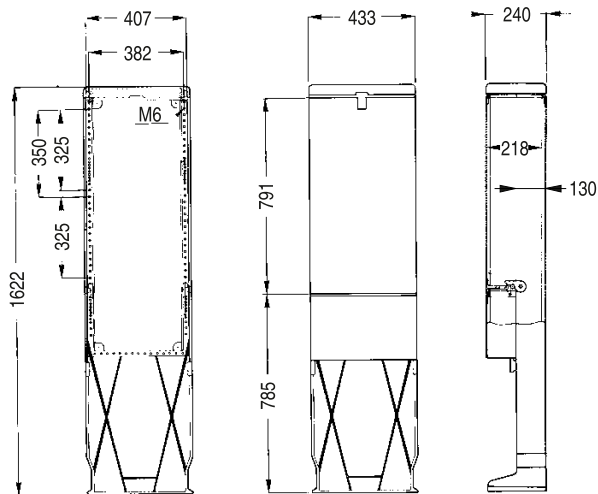

#### EH2-ND

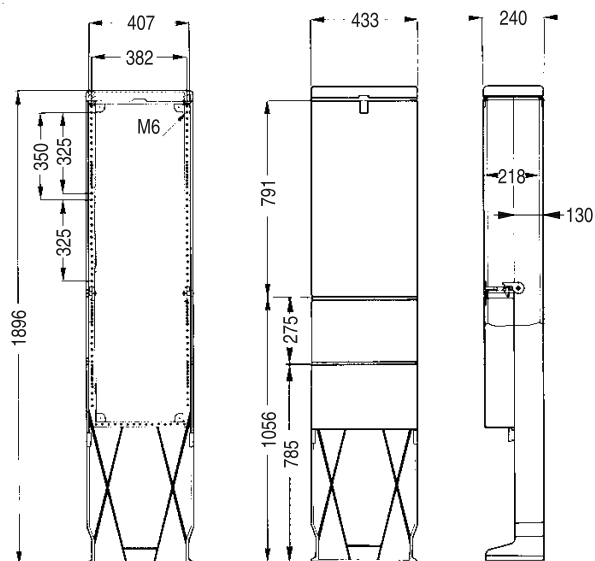

### EH2 - Mounting plates

#### EH2-NA

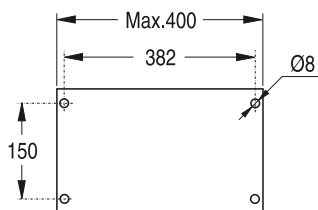

#### EH2-NB

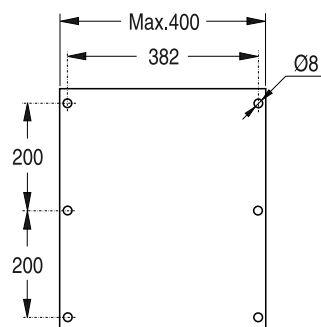

#### EH2-NC/ND

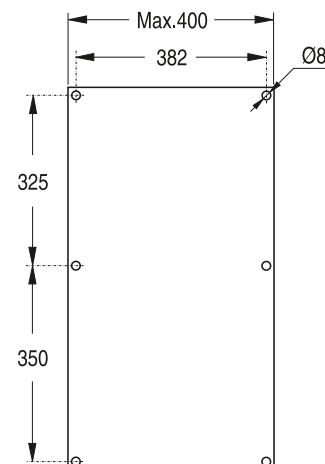

# Pedestals

## EH3 - Dimensional drawings

**EH3 - 00**

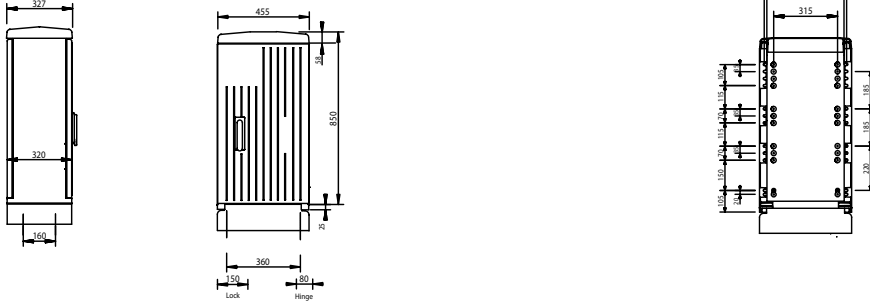

**EH3 - 0**

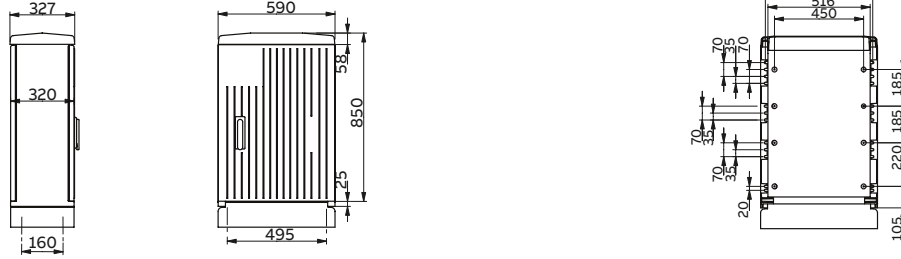

**EH3 - 1**

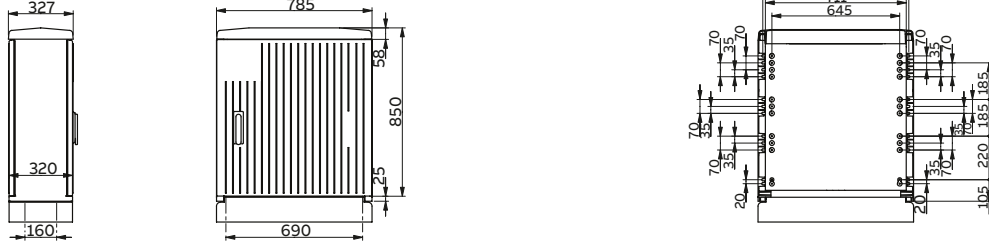

**EH3 - 2**

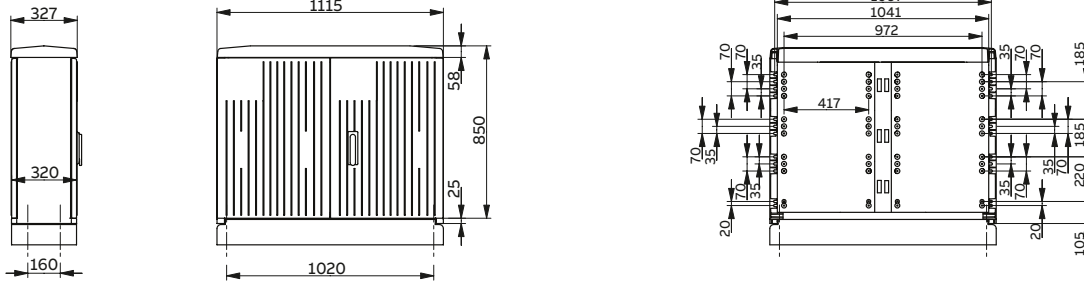

# Pedestals

## EH3 - Dimensional drawings

**EH3/AP - 200**

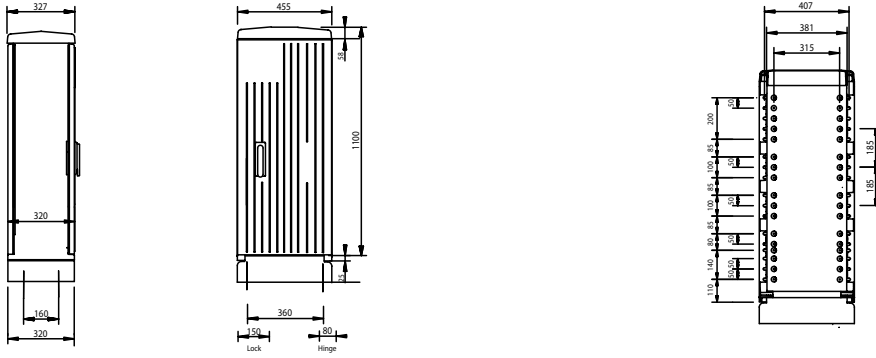

**EH3/AP - 20**

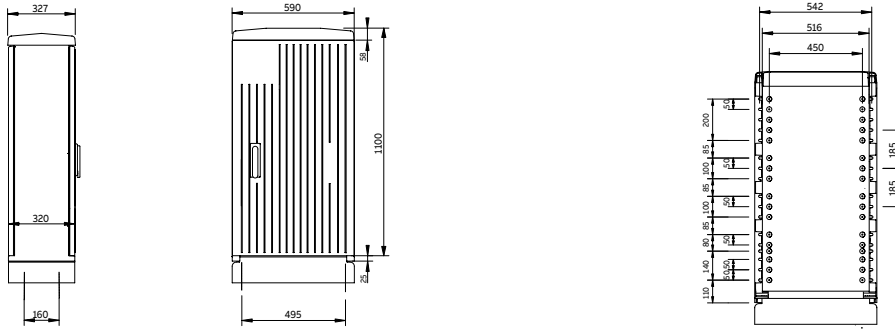

**EH3/AP - 21**

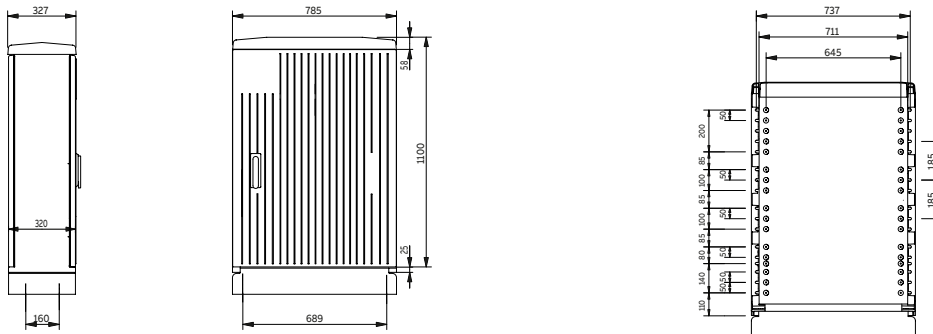

**EH3/AP - 22**

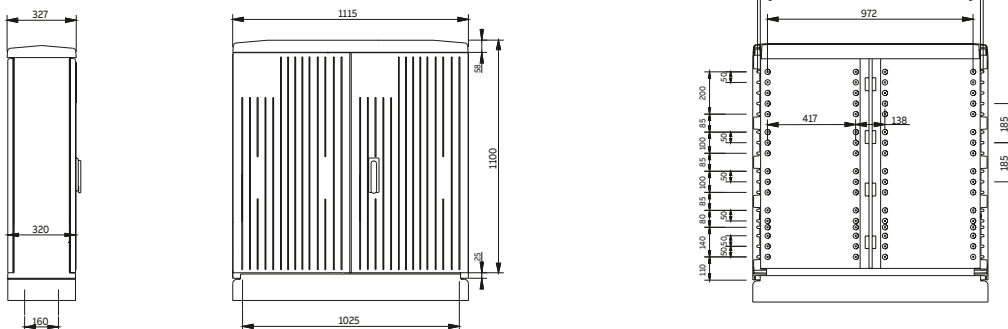

**Pedestals**

EH3 - Dimensional drawings

**EH3 - 3**

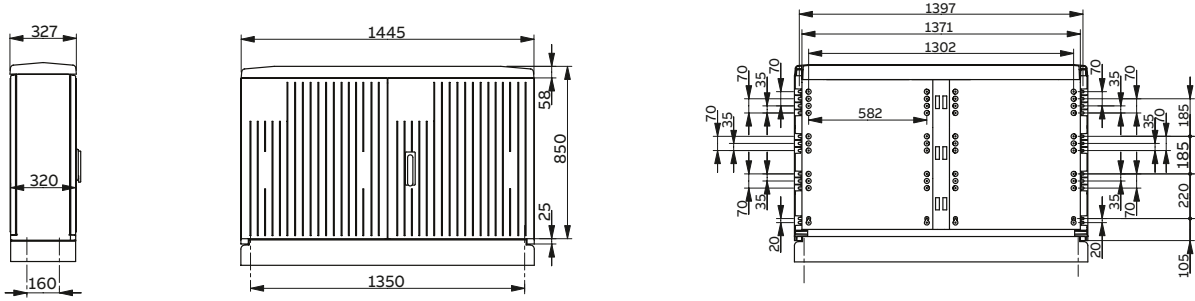

**EH3/AP - 23**

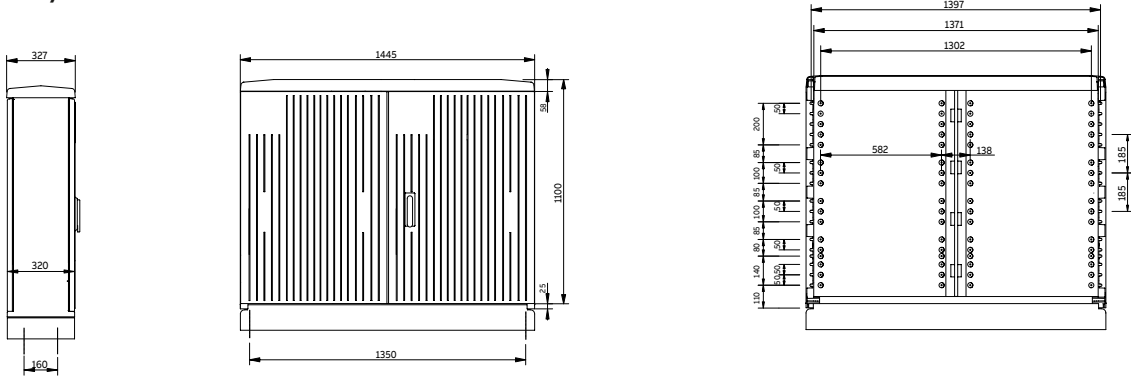

# Pedestals

## EH3 - Dimensional drawings

### Polyester bases DIN 00-0-1-2

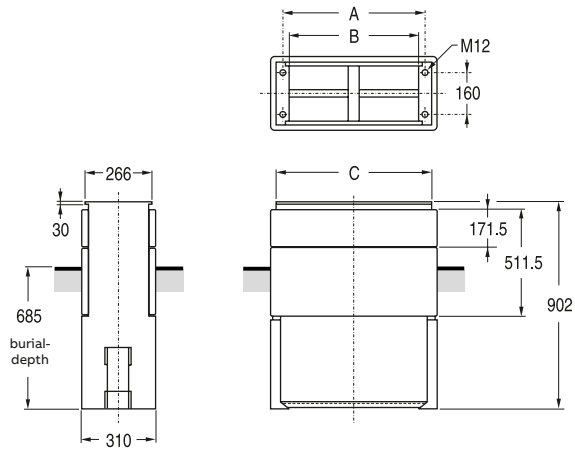

### Polyester bases DIN 3

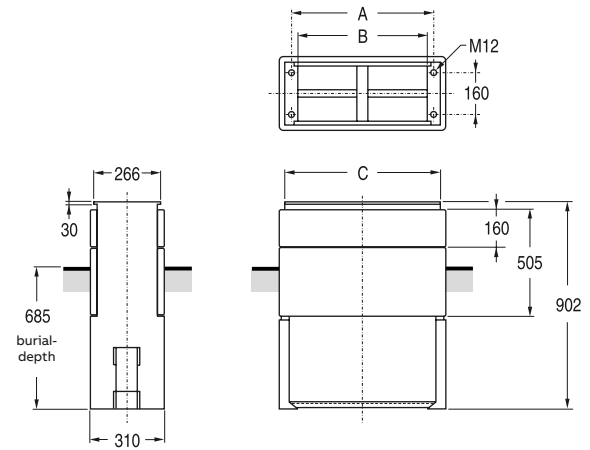

The dimensions of the base fixation points are in accordance with DIN 43629.

Dimensions				
DIN	00	0	1	2
A	360	495	690	1.020
B	322	457	652	982
C	408	543	738	1.068

Dimensions	
DIN	3
A	1.35
B	1.315
C	1.400

### Bottom plate

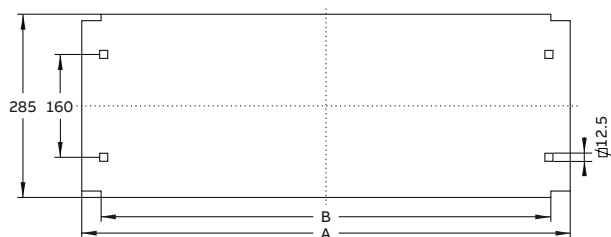

To be mounted between pedestal and DIN-base or as bottom plate of the enclosure.

Dimensions					
DIN	00	0	1	2	3
A	427	562	757	1.086	1.416
B	360	495	630	1.020	1.350

# Pedestals

## EH3 / GD - Dimensional drawings

### EH3/GD-AP 031 - EH3/GD-AP 041

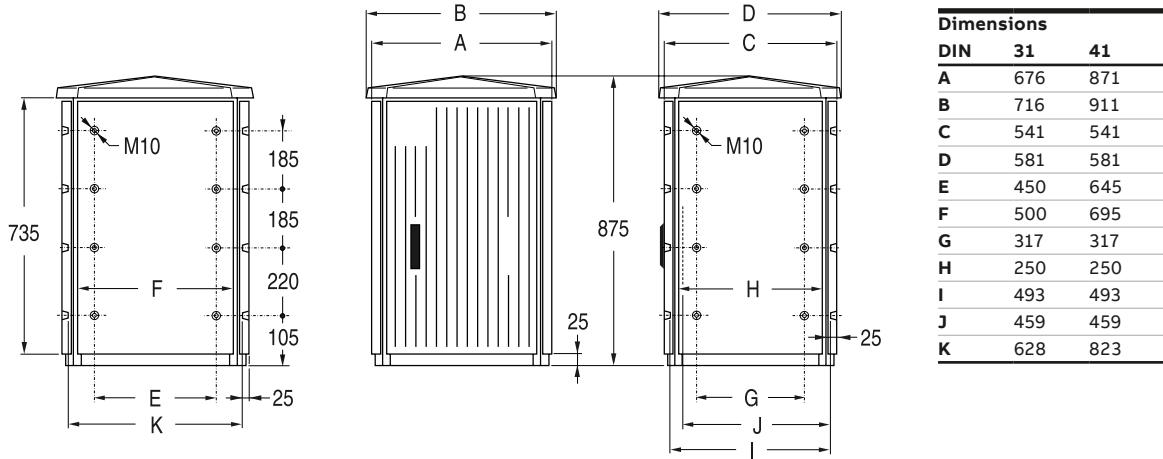

### EH3/GD-AP 051

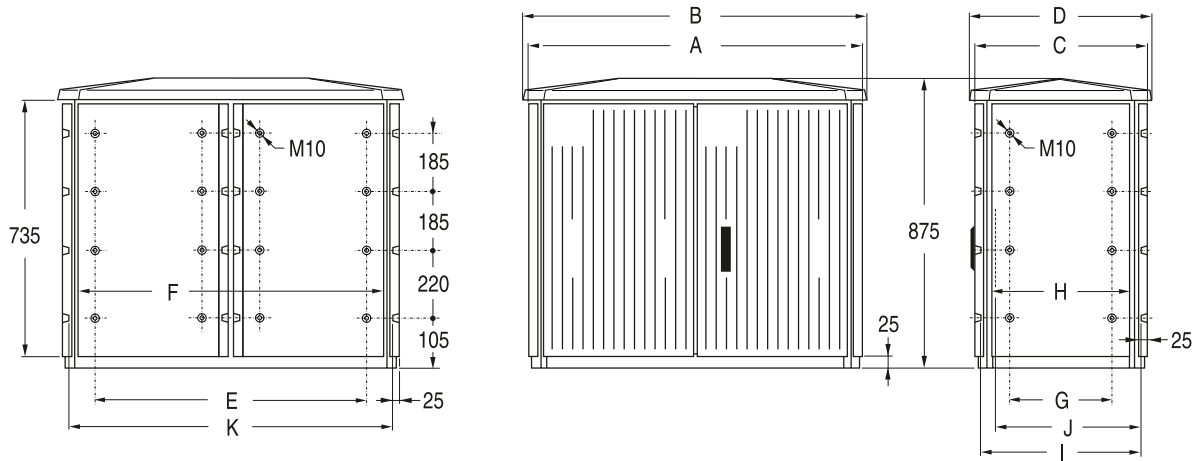

Dimensions											
DIN	A	B	C	D	E	F	G	H	I	J	K
51	1200	1240	541	581	972	1025	317	250	493	459	1.152

### Bottom plate

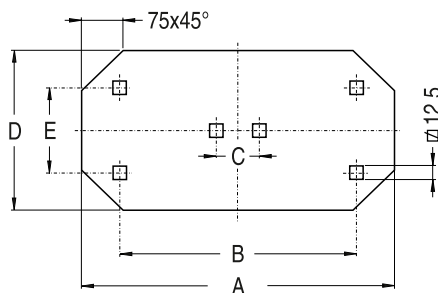

Dimensions						
DIN	31	233	41	243	51	253
A	635	635	830	830	1158	1158
B	495.5	496.5	691.5	691.5	1021	1021
C	-	-	-	-	50	50
D	380	632	388	632	380	632
E	245	498	246	498	245	498
No of holes	4	4	4	4	6	6

### Polyester base

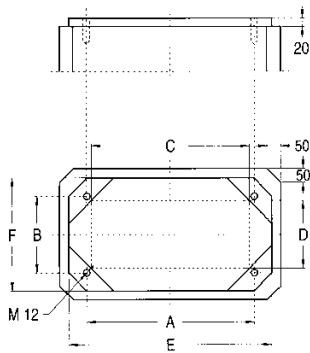

Dimensions						
DIN	31	233	41	243	51	253
A	498	498	693	693	1022	1022
B	246	498	246	498	246	498
C	456	456	651	651	980	980
D	205	456	204	456	204	456
E	626	626	821	821	1150	1150
F	374	626	374	626	374	626

## Pedestals

### EH3 / GD - Dimensional drawings

#### EH3/GD-AP 233 - EH3/GD-AP 243

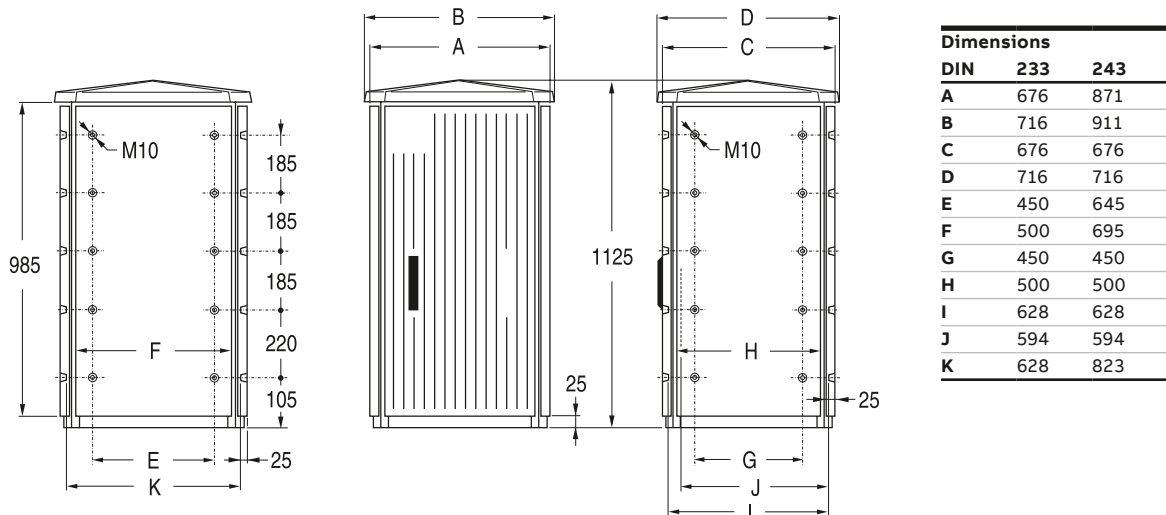

#### EH3/GD-AP 253

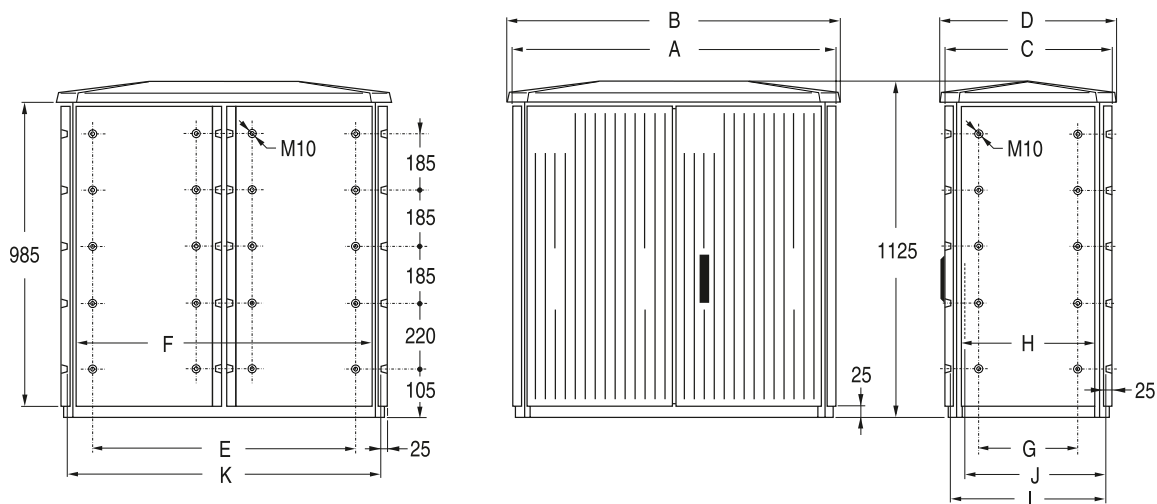

Dimensions											
DIN	A	B	C	D	E	F	G	H	I	J	K
253	1.200	1.240	676	716	972	1.025	450	500	628	594	1.152



## Pedestals

### EH4 - Dimensional drawings

#### EH4 - 00

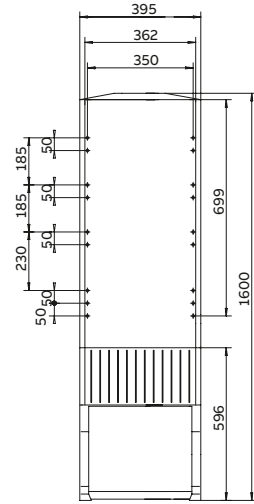
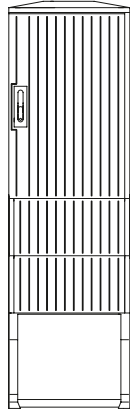
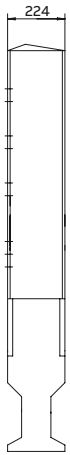

#### EH4 - 0

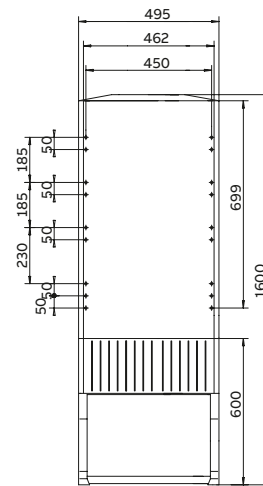
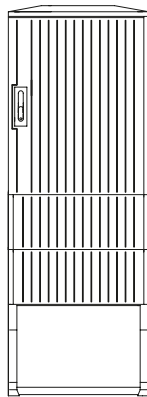
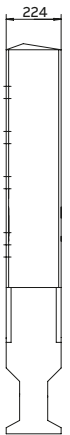

#### EH4 - 1

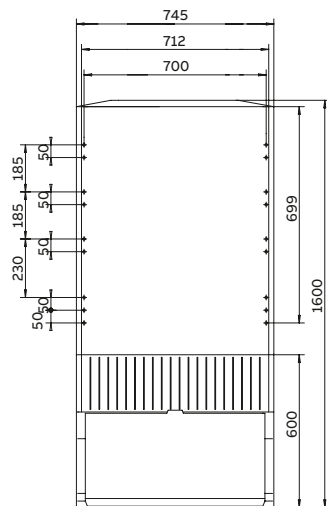
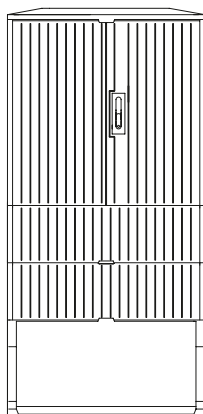
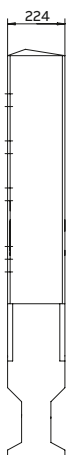

# Pedestals

## EH4 - Dimensional drawings

**EH4 - S1**

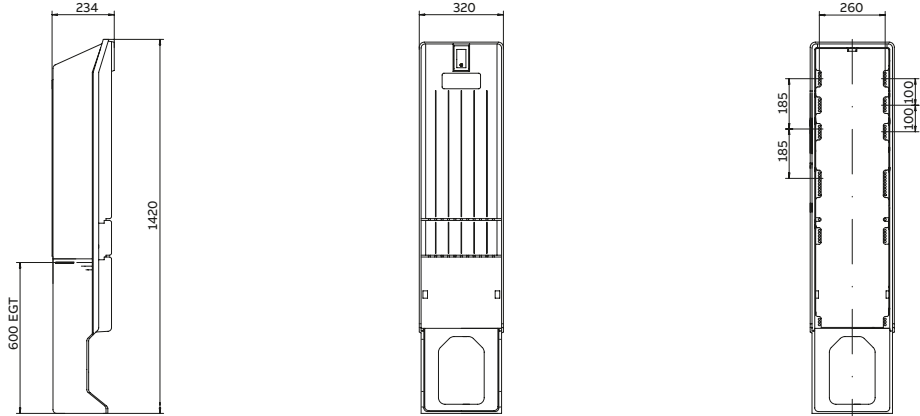

**EH4 - S2**

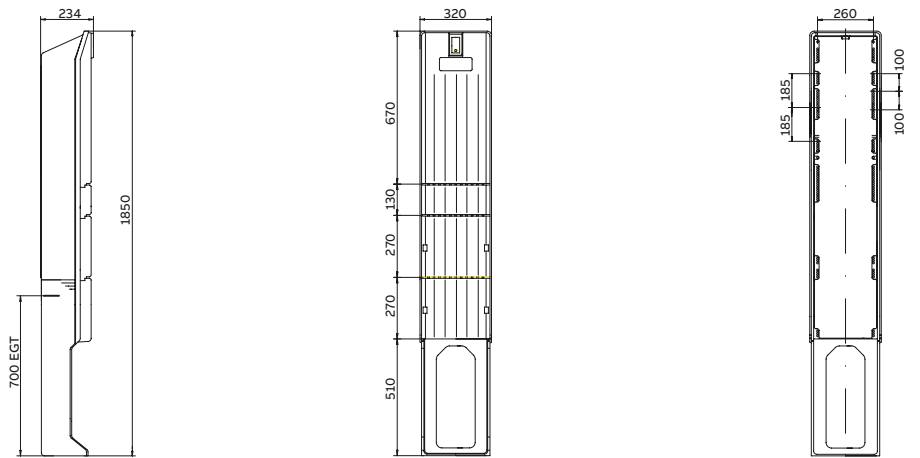

## Pedestals technical details

### EH Pedestals - Power dissipation values

Dissipation Watt	Temperature rise [Kelvin]									
	EH1 752×385×270		EH2-NA 256×433×240		EH2-NB 516×433×240		EH2-NC 791×433×240		EH2-ND 1066×433×240	
	Half	Top	Half	Top	Half	Top	Half	Top	Half	Top
10		5	7	8	5	6		5		5
20	7	9	13	14	8	10	7	8	5	8
30	10	12	17	19	11	14	9	12	7	11
40	12	15	22	24	14	17	12	15	9	14
50	18	26	29	17	21	14	17	11	17	
60	21	30	34	20	24	16	20	13	20	
70	24	34	38	23	27	18	23	14	23	
80	26	38	43	25	30	20	25	16	25	
90	29	42	47	28	33	23	28	18	28	
100	32	46	51	30	36	25	30	19	30	
120	37	53		35	42	28	35	22	35	
140	41			39	48	32	40	25	40	
160	46			44	53	36	44	28	44	
180	51			48		39	49	31	49	
200	55			53		43	53	34	53	
220				57		46		36	57	
240						50		39		
260						53		42		
280						56		44		
300								47		
350								53		

## Pedestals technical details

### EH Pedestals - Power dissipation values

Dissipation Watt	Temperature rise [Kelvin]							
	EH4-00 1.004×395×224		EH4-0 1.004×495×224		EH4-1 1.004×745×224		EH4-S1 820×320×234	
	Half	Top	Half	Top	Half	Top	Half	Top
10		4		5			4	5
20	6	8	5	8		6	7	9
30	9	11	7	11	5	8	10	13
40	11	14	9	14	7	10	13	16
50	13	16	11	17	8	12	15	19
60	15	19	13	20	9	14	18	22
70	17	21	14	22	11	15	20	25
80	19	24	16	25	12	17	22	28
90	21	26	18	27	13	19	25	31
100	23	28	19	29	14	21	27	34
120	26	33	22	34	16	24	31	39
140	30	37	25	39	19	27	35	44
160	33	41	28	43	21	30	39	49
180	36	45	31	47	23	33	43	54
200	39	49	33	51	25	36	47	59
220	42	53	36	55	27	39	51	64
240	46	57	39	59	29	42	54	68
260	49	61	41	63	31	44	58	73
280	52	65	44	67	33	47	62	77
300	55	68	46	71	34	50	65	
350	62	77	52		39	56	74	
400	69		58		43	63		
450	76		64		48	69		
500			70		52	75		
550			75		56			
600					60			
650					64			
700					68			
750					72			
800					76			
850					80			

## Pedestals technical details

### EH Pedestals - Power dissipation values

EH3 Stand alone	Temperature rise [Kelvin]																
	EH3/F-0 EH3/AP-0 875×590×320		EH3/F-1 EH3/AP-1 875×785×320		EH3/F-2 EH3/AP-2 875×1.115×320		EH3/F-3 EH3/AP-3 875×1.445×320		EH3/AP-20 1.125×590×320		EH3/AP-21 1.125×785×320		EH3/AP-22 1.125×1.115×320		EH3/AP-23 1.125×1.445×320		
	Dissipation Watt	Half	Top	Half	Top	Half	Top	Half	Top	Half	Top	Half	Top	Half	Top	Half	Top
10																	
20	5	6		5					5		4						
30	6	9	5	7		5			5	7	4	6		4			
40	8	11	6	9	5	6		5	6	9	5	7		5			4
50	10	13	8	10	6	7	5	6	8	11	6	8	5	6	4	5	
60	11	16	9	12	7	9	5	7	9	13	7	10	5	7	5	6	
70	13	18	10	13	7	10	6	8	10	14	8	11	6	8	5	7	
80	14	20	11	15	8	11	7	8	11	16	9	12	7	9	6	8	
90	16	22	12	16	9	12	7	9	12	18	10	14	7	10	7	9	
100	17	23	13	18	10	13	8	10	13	19	11	15	8	11	7	9	
120	20	27	15	21	11	15	9	12	15	22	12	17	9	12	8	11	
140	22	31	17	23	13	17	10	13	17	25	14	19	10	14	9	12	
160	25	34	19	26	14	19	12	15	19	28	15	22	12	16	10	14	
180	27	38	21	29	16	21	13	16	21	31	17	24	13	17	11	15	
200	29	41	23	31	17	22	14	18	23	33	18	26	14	19	13	16	
220	32	44	25	34	19	24	15	19	25	36	20	28	15	20	14	18	
240	34	47	27	36	20	26	16	21	27	39	21	30	16	22	14	19	
260	36	51	29	38	21	28	17	22	28	41	23	32	17	23	15	20	
280	39	54	30	41	23	29	18	23	30	44	24	34	18	25	16	21	
300	41	57	32	43	24	31	19	25	32	46	26	36	19	26	17	23	
350	46		36	49	27	35	22	28	36	52	29	40	22	29	20	26	
400	51		41	54	30	39	24	31	40		32	45	24	33	22	29	
450	57		45		33	43	27	34	44		35	50	27	36	24	31	
500			48		36	47	29	37	48		39	54	29	39	26	34	
550			52		39	51	31	40	52		42		31	42	28	37	
600			56		42	54	34	43	56		45		34	45	30	40	
650					45		36	46			48		36	48	32	42	
700					47		38	49			51		38	51	34	45	
750					50		40	51			53		40	54	36	47	
800					53		42	54			56		43		38	50	
850					55		44	57					45		40	52	
900							47						47		42	55	
950							49						49		44		
1.000							51						51		46		
1.100							55						55		49		
1.200															53		
1.300															56		





## Gemini: the improved range



## Gemini: the improved range

### Index

<b>Gemini: the improved range</b>	
Robust and flexible thermoplastic enclosures	170
Easy to install - Versatile and simple. To meet any application	172
High degree of protection - Designed to operate in harsh environments	174
Adaptable to customers' requirements	
Widest range and numerous accessories for a complete solution	175
Basic configuration	178
Components for automation applications	181
Components for distribution and mixed applications	186
Accessories	194
Fast selection table	199
Configurations examples	203
Technical details - Compliance with standards and technical characteristics	206
Technical details - IP degree of protection	208
Technical details - IK degree of resistance to impacts	209
Technical details - Double insulation and self-extinguishing tests	210
Technical details - Resistance to chemical agents	211
Technical details - Integration with ABB products	212
Technical details - Disposal instructions	213
Technical details - Overall dimensions – Basic configuration	214
Technical details - Overall dimensions – Components for automation applications	217
Technical details - Overall dimensions	
Components for distribution and mixed applications	218

# Gemini: the improved range

## Robust and flexible thermoplastic enclosures

Six different box sizes with internal space which accommodates from 24 to 216 DIN modules

Opaque or transparent doors, opening at more than 180°.



A single handle operates the door closing mechanism and it can be ordered separately.

Gemini is compliant to IEC62208 and UL 508A standards. IP66 certifies Gemini is completely protected against the infiltration of solid bodies and is resistant to the penetration of jets of water similar to sea waves.

High resistance: flexible and extremely sturdy. Resistant to harsh environments, chemical and atmospheric agents.



Suitable for outdoor installations, in any operating conditions: IP66, IK10, GWT=750°C, -25°C to 100°C



### Easy to install

Ready-to-use solutions are available to quickly install all the devices without using tools.



### High degree of protection

Extremely sturdy, even against 20 joules impact, dust and water jets (IK10 and IP66 degree of protection), able to operate in a wide range of temperatures (25 up to 100°C), exceptionally resistant to UV and chemical agents and compliant with IEC 62208 and UL 508A standards.



### Adaptable to customers' requirements

Available in 6 sizes and with transparent or blind door, with full metal and plastic base plates. Gemini can be used even in very difficult application circumstances and extreme weather conditions.



### Eco-friendly

Thanks to co-injection technology, Gemini's thermoplastic not only ensures sturdiness, mechanical features and resistance to oils but it also reduces at the same time the environmental impact at the end of its useful life since it's 100% recyclable.

### The thermoplastic co-injection molding process

It's like a "sandwich" of two materials: a compact external covering and an expanded core. This technology ensures the highest level of mechanical protection against impacts (IK10).



## Easy to install

Versatile and simple. To meet any application.

Offering the best technology for more reliable energy distribution solutions, by protecting people, equipments and resources.

ABB's Gemini enclosures provide a real system of integrated and complementary functions making them configurable into different applications: for automation, distribution and combined automation and distribution.

Gemini is designed to be perfectly compatible with ABB components for low voltage control and monitoring. In mixed applications, the Gemini enclosure is designed to be fitted with System pro M modular devices and Tmax XT moulded-case circuit breakers. To respect safety standards, all the enclosure components are easy to fit and can be fixed to the base plate or to the box frame without using any tools.

Wiring operations are carried out from the front followed by snapping the base plate or the distribution frame onto the box.

The patented frame is fitted with the cable duct incorporated in the uprights.

For control and command applications, three typologies of base plates are available: standard metal, perforated metal and insulated.

Lightweight thermoplastic material makes handling operation easier compared to traditional enclosure, for easier handling.



- Few parts: **snap-on fixing, no tools needed**
- **Pre-assembled hinges**
- Door with **180 degree rotation**
- Frame with **integrated vertical wiring duct**
- Frontal cabling: **comfort in the wiring process**
- **A wide range of accessories for automation and distribution applications**

Gemini is also flexible thanks to six different box sizes and internal space to accommodate from 24 to 216 DIN modules.

—  
01 Gemini doors open at an angle of more than 180° giving easy access to the devices installed inside the switchboard.

—  
02 No tools are needed for installation. The doors hook onto the hinges with special hinge pins and are reversible.

—  
03 The frame can be extracted to make wiring operations easier at the workbench.

—  
04 The fixing hooks supplied in the standard versions are applied without having to use tools.

—  
05 Fixing hooks and feet allow the frame to be snap-mounted inside the box.



—  
05

# High degree of protection

## Designed to operate in harsh environments

Gemini is developed and designed by ABB together with the direct collaboration of panel builders, installers and designers in order to create insulating enclosures to better face extreme weather conditions.

Gemini represents the best solution for both distribution and automation (control and command) applications.

For a valid enclosure, the degree of protection is an important factor. Gemini thermoplastic enclosures are totally protected against the infiltration of solid bodies thanks to an IP66 degree of protection (IP30 with the door open and with the appropriate components installed) and a double insulation, even in the event of indirect contact.

—

They are suitable for environments with extreme temperatures, in outdoor applications and severe conditions.

Thermoplastic material retains its characteristics for a long time since it's not subject to corrosion from chemical and atmospheric agents such as dust and sand. In Mining or Construction applications as well as manufacturing plants, Gemini withstands harsh chemicals with high levels of performance.

Typical examples of some Gemini applications can be seen in Manufacturing sites, Solar power plants, greenhouses, chemical plants and in any other environments where distribution and automation demand specific safety requirements and service continuity.

It is particularly recommended in photovoltaic and greenhouse applications, also because of its strong resistance to UV rays.



- **IP66 degree of protection** (IP30 with the door open and with the appropriate components installed)
- **Double insulation from dust and water jets**, even in the event of indirect contact
- Adaptation to environments with extremely high or low temperatures (**-25°C to 100°C**), in outdoor applications and in severe conditions
- **Resistance to aggressive chemical agents and UV radiation**
- Resistance to fire and abnormal heat (**GWT up to 750°C**).
- Insulation Voltage: **1000 Vac; 1500 Vdc**
- UL Type **1, 3R, 4, 4X, 12**

#### Additional tests completed

- Dust/sand resistance (factory internal tested)
- Saline environments (according to IEC 60068-2-52)
- Weathering (according to IEC 60068-2-5)
- Permanent sun exposure (IEC 60068-2-5)





---

## Photovoltaic

In a typical photovoltaic plant the direct current section comprises a generator consisting of strings composed of photovoltaic modules connected in series. The Gemini series of IP66 enclosures are ideal for use as field combiners or as parallel switchboards, i.e. for outdoor installation near the modules. ABB has a range which is currently unique on the market, and has developed a family of plug & operate solutions, i.e. a series of finished, wired and certified switchboards to meet the needs of a huge range of plant types: from single string for residential applications to large-scale solar fields (for more information see specific documentation on [abb.com](http://abb.com)).

## Adaptable to customers' requirements

Widest range and numerous accessories for a complete solution

With Gemini, you can benefit from a wide range of enclosures with different dimensions and the possibility to arrange the devices into the DIN-Rail as you need. Moreover, Gemini enclosures have a wide range of accessories for both automation and distribution applications, ensuring maximum versatility and integration.

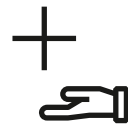

### Accessories

- Various locking systems can be installed (triangular, squared, with handles and ciphered type)
- Ventilation and anti-condensation kits: protecting devices from the effects of heat and humidity
- Wall brackets, pole mounting kit and pedestal make it easier to install the enclosures in any context.
- Kit for installing Tmax XT circuit-breakers
- The universal drill bit can be used to create the holes to install the cable glands for cable derivations
- Doors with single central handle (as per picture beside) can be fitted with half cylinder locking systems and/or padlock



—  
01—  
02—  
03

—  
01 Doors with central single handle are also available.

—  
02 Wall-mounted installation is possible using the special mounting brackets.

—  
03 ABB logo with its minimal graphic design fits well to hinged doors .

—  
04 Pole-mounted or mounted on a special pedestal installation is also possible.

—  
05 The standard double-bit locks supplied can be replaced by the version with ciphered key and handle or with square or triangular impression.

—  
04—  
05

## General Purpose Enclosures

### Gemini - Basic configuration

In the basic configuration, Gemini switchboards are composed of boxes in six different sizes ranging from 335x400x210 mm to 840x1005x360 mm (WxHxD, external measurements) and with opaque or transparent doors. In both versions, the doors are reversible and clip onto the hinges without the need to use tools; the fact that they open at an angle of more than 180° means that it is easy to work on the components installed inside the switchboard. The seal applied by extrusion along the sides of the doors guarantees IP66 degree of protection. Access to the inside

of the switchboard is protected by a standard double bit lock that can be replaced by locks of another type available in the accessories. Boxes and doors can be requested either separately or as combined "box + door" codes, to make filling out the order form more flexible. Inside the packages, the door is always wrapped separately and inserted inside a pocket that protects it from accidental damage until wiring is completed and the switchboard is installed. Hole-cover plugs to guarantee IP protection and double insulation for wall mounting are also supplied with the pack together with the instruction sheet.

Specifications	
Protection	IP66 (IEC EN 60529) Class II insulation
Strength	Thermoplastic material moulded in co-injection Resistance to abnormal heat and fire up to a temperature of 750 °C (IEC EN 60695-2-11) IK10 (IEC EN 50102) degree of resistance to impacts Protection against chemical and atmospheric agents (water, saline solutions, acids, basic agents, mineral oils, UV rays) Operating temperature -25 °C ÷ +100 °C
Performances	Rated service voltage up to 1000 V Rated insulating DC voltage up to 1000 V Rated insulating AC voltage up to 1500 V
Flexibility of use	6 sizes from 335x400x210 mm to 840x1005x360 mm (WxHxD, external dimensions) DIN 24 to 216 modules
Installation	Snap-on mounting of all components in compliance with safety Standards
Quality and environment	Compliance with CEI EN 62208 international reference Standard, qualification for the requirements of CEI EN 61439-1 Standard, IMQ mark according to EN 62208 Standard. 100% recyclable EN 60068-2-52 resistance to marine environments EN60068-2-5 resistance direct sun exposure UL Listed: UL508A, UL50, UL50E Nema: Types 1, 3R, 4, 4X, 12



Gemini doors open at an angle of more than 180° giving easy access to the devices installed inside the switchboard.



No tools are needed for installation. The doors hook onto the hinges with special hinge pins and are reversible.

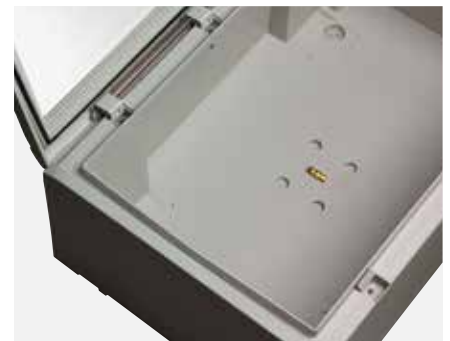

The special structure of the inner perimeter of the box ensures further protection against the penetration of water. The box is supplied with a spirit level.

## General purpose enclosures

### Gemini - Basic configuration

#### Boxes and doors

- Available in 6 sizes
- Single order code combined with box and transparent and opaque door
- Pack with door dismounted and wrapped separately
- Door designed so that it can be hooked onto hinges at both vertical sides and mounted without the use of tools
- To be mounted to the wall using internal holes or fixing brackets supplied as accessories
- Door opening at an angle of more than 180°
- RAL 7035 grey color
- Doors supplied with 2 standard double bit locks (3 for sizes 5 and 6) that can be replaced with locks for ciphered key or with square/triangular impression (the standard triplex key is suitable for use with three types of impressions).

#### Transparent door

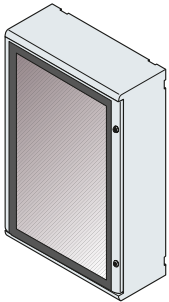

Transparent door switchboard

Size	External		Modules		Code	Unit/Pack
	Dimensions WxHxD (mm)	Internal WxHxD (mm)	Max No. DIN mod.	No. vertical mod. (H=150 mm)		
1	335x400x210	250x300x180	24 (12x2)	2	1SL0211A00	1/1
2	460x550x260	375x450x230	54 (18x3)	3	1SL0212A00	1/1
3	460x700x260	375x600x230	72 (18x4)	4	1SL0213A00	1/1
4	590x700x260	500x600x230	96 (24x4)	4	1SL0214A00	1/1
5	590x855x360	500x750x330	120 (24x5)	5	1SL0215A00	1/1
6	840x1005x360	750x900x330	216 (36x6)	6	1SL0216A00	1/1

#### Opaque door

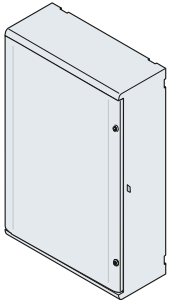

Opaque door switchboard

Size	External		Modules		Code	Unit/Pack
	Dimensions WxHxD (mm)	Internal WxHxD (mm)	Max No. DIN mod.	No. vertical mod. (H=150 mm)		
1	335x400x210	250x300x180	24 (12x2)	2	1SL0201A00	1/1
2	460x550x260	375x450x230	54 (18x3)	3	1SL0202A00	1/1
3	460x700x260	375x600x230	72 (18x4)	4	1SL0203A00	1/1
4	590x700x260	500x600x230	96 (24x4)	4	1SL0204A00	1/1
5	590x855x360	500x750x330	120 (24x5)	5	1SL0205A00	1/1
6	840x1005x360	750x900x330	216 (36x6)	6	1SL0206A00	1/1

## General Purpose Enclosures

### Gemini - Basic configuration

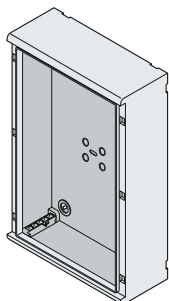

Single box



Transparent door



Opaque door

#### Single boxes

Size	External dimensions WxHxD (mm)	Internal WxHxD (mm)	Code	Unit/Pack
1	335x400x210	250x300x180	1SL0221A00	1/1
2	460x550x260	375x450x230	1SL0222A00	1/1
3	460x700x260	375x600x230	1SL0223A00	1/1
4	590x700x260	500x600x230	1SL0224A00	1/1
5	590x855x360	500x750x330	1SL0225A00	1/1
6	840x1005x360	750x900x330	1SL0226A00	1/1

#### Single doors

##### Transparent door

Size	Box dimensions WxHxD (mm)	Code	Unit/Pack
1	335x400x210	1SL0241A00	1/1
2	460x550x260	1SL0242A00	1/1
3	460x700x260	1SL0243A00	1/1
4	590x700x260	1SL0244A00	1/1
5	590x855x360	1SL0245A00	1/1
6	840x1005x360	1SL0246A00	1/1

##### Opaque door

Size	Box dimensions WxHxD (mm)	Code	Unit/Pack
1	335x400x210	1SL0231A00	1/1
2	460x550x260	1SL0232A00	1/1
3	460x700x260	1SL0233A00	1/1
4	590x700x260	1SL0234A00	1/1
5	590x855x360	1SL0235A00	1/1
6	840x1005x360	1SL0236A00	1/1

#### Door with handle

##### Transparent door with handle

Size	Box dimensions WxHxD (mm)	Code	Unit/Pack
3	460x700x260	1SLM006600A0243	1/1
4	590x700x260	1SLM006600A0244	1/1
5	590x855x360	1SLM006600A0245	1/1
6	840x1005x360	1SLM006600A0246	1/1

##### Opaque door with handle

Size	Box dimensions WxHxD (mm)	Code	Unit/Pack
3	460x700x260	1SLM006600A0233	1/1
4	590x700x260	1SLM006600A0234	1/1
5	590x855x360	1SLM006600A0235	1/1
6	840x1005x360	1SLM006600A0236	1/1



## General purpose enclosures

### Gemini - Components for automation applications

Gemini switchboards are designed to be perfectly compatible with ABB components for low voltage control and monitoring. For these applications they can be equipped with modular devices belonging to the System pro M range, with Tmax moulded-case circuit-breakers and control and signalling devices, creating a truly integrated automation system. When deciding the Gemini layout for control and monitoring applications, not only is it possible to select the box and door in the required size, but you can also select the base plate in one of the three versions in the range.

After wiring with the ducts and the Fix-O-Rapid device, the special standard adjustable feet and hooks must be fitted onto the base plate, allowing it to be inserted inside the box at up to seven different depths and three further levels of adjustment: no tools need to be used to carry out these operations. To finish the job, the inner door can be mounted (reversible and in insulating material), guaranteeing IP30 degree of protection when the switchboard door is open. No tools are needed unless the inner door is equipped with buttons, warning lights, etc.



The fixing hooks and feet supplied in the standard versions are applied without having to use tools, making it possible to install the base plate at seven different depths inside the switchboard. They can also be adjusted at three further positions.

Application of the inner door guarantees IP30 degree of protection when the switchboard door is open.



Example of the configuration of a switchboard for an automation application: some ABB control and protection devices are installed on the plate. The inner door is fitted with light-signaling devices.

## General purpose enclosures

### Gemini - Components for automation applications

#### Base plates

- Available in three versions in blank or drilled metal and insulating material
- Positioning at 3 different depths for size 1, 4 different depths for sizes 2-3-4 and 7 different depths for sizes 5-6 (adjustments with 30 mm pitch)
- Supplied with feet and hooks adjustable at three further positions (with 7.5 mm pitch)
- Snap-on mounting
- Plates can also be mounted directly on the base with the special kit.

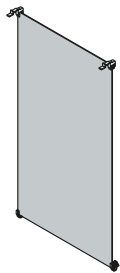

Blank metal base plate

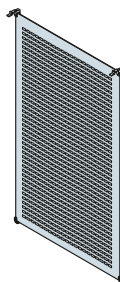

Drilled metal base plate

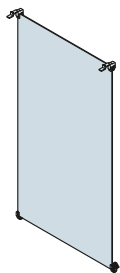

Insulating material base plate

#### Blank metal

Size of the switchboard	Code	Unit/Pack
1	1SL0259A00	1/6
2	1SL0260A00	1/6
3	1SL0261A00	1/4
4	1SL0262A00	1/4
5	1SL0263A00	1/4
6	1SL0264A00	1/2

#### Drilled metal

Size of the switchboard	Code	Unit/Pack
1	1SL0275A00	1/6
2	1SL0276A00	1/6
3	1SL0277A00	1/4
4	1SL0278A00	1/4
5	1SL0279A00	1/4
6	1SL0280A00	1/2

#### Insulating material

Size of the switchboard	Code	Unit/Pack
1	1SL0267A00	1/6
2	1SL0268A00	1/6
3	1SL0269A00	1/4
4	1SL0270A00	1/4
5	1SL0271A00	1/4
6	1SL0272A00	1/2

Description	Code	Unit/Pack
Base mounting kit for metal plate	1SL0383A00	1/10

## General purpose enclosures

Gemini - Components for automation applications

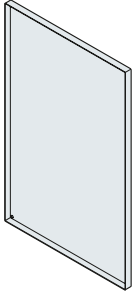

Inner door, sizes 1-2

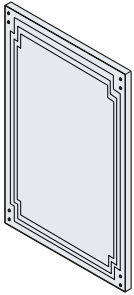

Inner door, sizes 3-4-5-6

### Inner doors

- Made in insulating material
- IP30 degree of protection with door open
- Designed so that door can be hinged onto both vertical sides
- Snap-on mounting and fixing

Size of the switchboard	Code	Unit/Pack
1	1SL0251A00	1/4
2	1SL0252A00	1/4
3	1SL0253A00	1/2
4	1SL0254A00	1/2
5	1SL0255A00	1/2
6	1SL0256A00	1/1

## General purpose enclosures

### Gemini - Components for automation applications

#### Wiring ducts

- Made in self-extinguishing thermoplastic material (UL 94 V0), resistant to abnormal heat and fire up to 960 °C (IEC 695-2-1)
- RAL 7030 grey color
- Available in version with 8/12 mm and 4/6 mm slots
- Base strip designed to snap onto Fix-O-Rapid
- Available in standard lengths of 2 m

#### With 8/12 mm slots

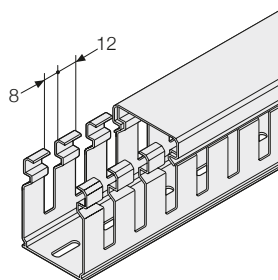

Wiring duct  
with 8/12 mm slot

Dimensions WxH (mm)	Code	Weight (kg/m)	Unit/ Pack- meters
15x17	05 019	0,06	46
25x30	05 033	0,21	58
25x40	05 043	0,25	48
25x60	05 063	0,24	34
25x80	05 083	0,29	28
25x100	05 094	0,46	20
40x30	05 035	0,27	40
40x40	05 045	0,31	30
40x60	05 065	0,34	22
40x80	05 085	0,38	36
40x100	05 095	0,53	28
60x30	05 037	0,38	52
60x40	05 047	0,46	40
60x60	05 067	0,47	32
60x80	05 087	0,50	24
60x100	05 096	0,73	20
80x40	05 049	0,47	32
80x60	05 069	0,52	24
80x80	05 089	0,59	16
80x100	05 097	0,91	14
100x40	05 051	0,55	24
100x60	05 071	0,59	20
100x80	05 091	0,68	16
100x100	05 098	1,06	8
120x40	05 053	0,65	20
120x60	05 073	0,73	14
120x80	05 093	0,89	12
150x100	05 099	1,37	8



## General purpose enclosures

### Gemini - Components for automation applications

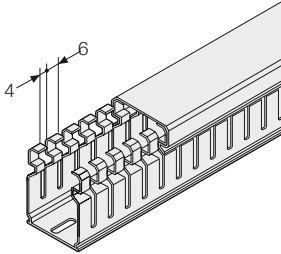

Wiring duct  
with 4/6 mm slot

#### With 4/6 mm slots

Dimensions WxH (mm)	Code	Weight (kg/m)	Unit/ Pack- meters
15x17	05 119	0,06	46
25x30	05 133	0,21	58
25x40	05 143	0,25	48
25x60	05 163	0,24	34
25x80	05 183	0,29	28
25x100	05 194	0,46	20
40x30	05 135	0,27	40
40x40	05 145	0,31	30
40x60	05 165	0,34	22
40x80	05 185	0,38	36
40x100	05 195	0,53	28
60x30	05 137	0,38	52
60x40	05 147	0,46	40
60x60	05 167	0,47	32
60x80	05 187	0,50	24
60x100	05 196	0,73	20
80x40	05 149	0,47	32
80x60	05 169	0,52	24
80x80	05 189	0,59	16
80x100	05 197	0,91	14
100x40	05 151	0,55	24
100x60	05 171	0,59	20
100x80	05 191	0,68	16
100x100	05 198	1,06	8
120x40	05 153	0,65	20
120x60	05 173	0,73	14
120x80	05 193	0,89	12
150x100	05 199	1,37	8

#### Fix-O-Rapid

Rapid mounting device for attaching wiring ducts to the base plate: it snaps onto the plate after drilling a  $\varnothing 7$  mm hole. Two Fix-O-Rapid devices are enough for each wiring duct section. Fix-O-Rapid guarantees maximum insulation since it does not involve the use of any metal component inside the wiring duct. If the wrong wiring duct is selected, it can be dismounted and a version with the same base and a different height can be attached to the Fix-O-Rapid.

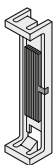

Fix-O-Rapid

Description	Code	Unit/ Pack-no. pieces
Rapid mounting device for wiring duct, W 25 mm	05 270	20/600
Rapid mounting device for wiring duct, W 40 mm	05 272	20/600
Rapid mounting device for wiring duct, W 60 mm	05 274	20/600
Rapid mounting device for wiring duct, W 80 mm	05 276	20/240
Rapid mounting device for wiring duct, W 100 mm	05 278	20/240
Rapid mounting device for wiring duct, W 120 mm	05 280	20/240
Rapid mounting device for wiring duct, W 150 mm	05 282	20/240

## General purpose enclosures

### Gemini - Components for distribution and mixed applications

In distribution and mixed applications, the Gemini switchboard is designed to be fitted with System pro M modular devices and Tmax moulded-case circuit breakers. The frame is the load-bearing element of the configuration: DIN rails, partial modular plates and the special Tmax mounting and cabling kits are snapped onto the uprights. All the components can be adjusted to six different depths with a pitch of 12.5 mm and arranged at heights with standard installation pitch of 150, 225 and 300 mm and a dis-

tance of 75 mm between the rows. Blank or drilled front panels are applied to protect the equipment and these can be hinged onto both sides; the cables are housed inside the vertical wiring duct integrated in the uprights according to an exclusive ABB patent. Wiring is carried out by pulling out the frame and working from the front; the ergonomic grip and the standard feet and snap-on hooks supplied make it easy to insert it inside the switchboard after the job is finished.

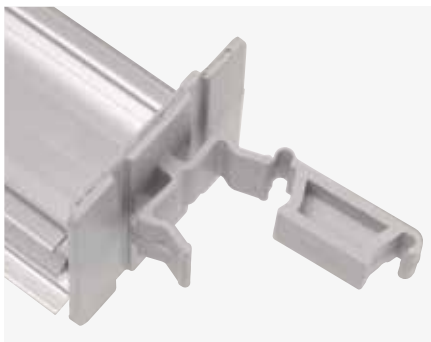

The DIN rail is supplied with special hooks already in position for attaching to the uprights.



The upright with the incorporated wiring duct is an exclusive ABB patent that rationalizes the path of cables inside the switchboard.



The depth at which the DIN rail, the modular plates, the kit for fixing the Tmax circuit breakers and the wiring duct are positioned can be adjusted with a simple sliding movement.



The frame can be extracted to make wiring operations easier at the workbench.



The blank and drilled panels are hinged onto both sides; the description of the installed components can be kept in the special compartment protected by a transparent, hinged flange.



Fixing hooks and feet allow the frame to be snap-mounted inside the box.



## General purpose enclosures

Gemini - Components for distribution and mixed applications

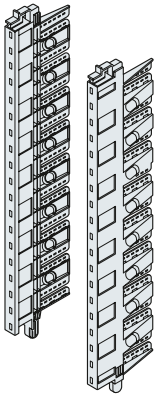

Uprights

### Uprights

- Incorporated vertical wiring duct (ABB patent)
- Snap-on mounting of all components (installation pitch of 75 mm)
- Snap-on insertion into box
- Depth of installed components adjusted at a pitch of 12.5 mm  
(4 positions for uprights of size 1 and 6 positions for the remaining ones)
- Ergonomic grip to make it easy to insert and extract

Size of the switchboard	Code	Unit/Pack
1	1SL0283A00	1/4
2	1SL0284A00	1/4
3	1SL0285A00	1/4
4	1SL0285A00	1/4
5	1SL0286A00	1/2
6	1SL0287A00	1/1

### DIN rails

- Two-sided version
- Supplied with mounting supports that snap onto uprights
- Depth adjustment on uprights
- Designed so that rapid Unifix L mounting bars can be snapped on

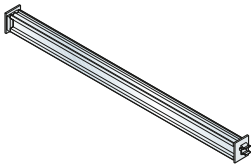

DIN rail

Size of the switchboard	Modules per row	Code	Unit/Pack
1	12	1SL0290A00	1/10
2	18	1SL0291A00	1/10
3	18	1SL0291A00	1/10
4	24	1SL0292A00	1/10
5	24	1SL0292A00	1/10
6	36	1SL0293A00	1/10

## General purpose enclosures

Gemini - Components for distribution and mixed applications

### Drilled panels

- Supplied with DIN rail complete with supports to snap onto uprights and adjustable in depth
- Available in 1 module (H 150 mm) and 1+1/2 module (H 225 mm, sizes 2-6) dimensions
- Designed to be hinged onto both vertical sides
- Snap-on mounting onto uprights (in compliance with reference Standards a tool must be used for removing the panel)
- Document pocket for storing descriptions of installed devices

### 1 module

Size of the switchboard	Code	Unit/Pack
1	1SL0307A00	1/8
2	1SL0308A00	1/8
3	1SL0308A00	1/8
4	1SL0309A00	1/4
5	1SL0309A00	1/4
6	1SL0310A00	1/2

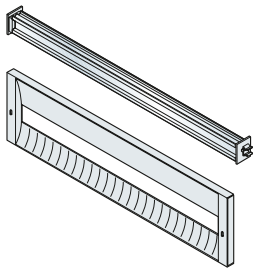

Drilled panel, 1 module

### 1 + 1/2 module

Size of the switchboard	Code	Unit/Pack
2	1SL0313A00	1/8
3	1SL0313A00	1/8
4	1SL0314A00	1/4
5	1SL0314A00	1/4
6	1SL0315A00	1/2

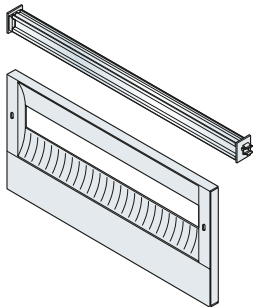

Drilled panel, 1 + 1/2 module

## General purpose enclosures

Gemini - Components for distribution and mixed applications

### Blank panels

- Available in 1/2 module (H 75 mm), 1 module (H 150 mm) and 2 modules (H 300 mm) dimensions
- H 150 mm and H 300 panels designed to be hinged onto both vertical sides
- Snap-on mounting onto uprights (in compliance with reference Standards a tool must be used for removing the panel)

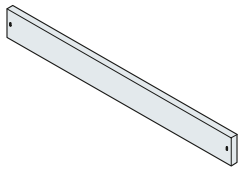

Blank panel, 1/2 module

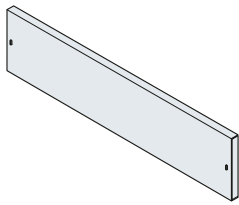

Blank panel, 1 module

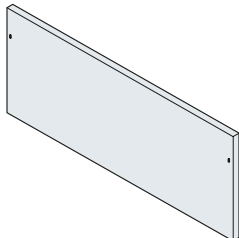

Blank panel, 2 modules

### 1/2 module

Size of the switchboard	Code	Unit/Pack
1	1SL0318A00	1/10
2	1SL0319A00	1/10
3	1SL0319A00	1/10
4	1SL0320A00	1/6
5	1SL0320A00	1/6
6	1SL0321A00	1/4

### 1 module

Size of the switchboard	Code	Unit/Pack
1	1SL0324A00	1/8
2	1SL0325A00	1/8
3	1SL0325A00	1/8
4	1SL0326A00	1/4
5	1SL0326A00	1/4
6	1SL0327A00	1/4

### 2 modules

Size of the switchboard	Code	Unit/Pack
1	1SL0330A00	1/6
2	1SL0331A00	1/6
3	1SL0331A00	1/6
4	1SL0332A00	1/4
5	1SL0332A00	1/4
6	1SL0333A00	1/4

## General purpose enclosures

Gemini - Components for distribution and mixed applications

### Partial modular plates

- Available in 1 module (H 150 mm) and 2 module (H 300 mm, sizes 2-6) dimensions
- Snap-on mounting onto uprights with depth adjustment.

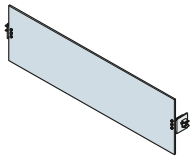

Partial modular plate,  
1 module

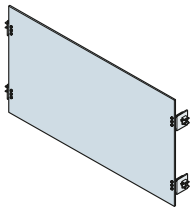

Partial modular plate,  
2 modules

### 1 module

Size of the switchboard	Code	Unit/Pack
1	1SL0296A00	1/6
2	1SL0297A00	1/4
3	1SL0297A00	1/4
4	1SL0298A00	1/4
5	1SL0298A00	1/4
6	1SL0299A00	1/2

### 2 modules

Size of the switchboard	Code	Unit/Pack
2	1SL0302A00	1/4
3	1SL0302A00	1/4
4	1SL0303A00	1/4
5	1SL0303A00	1/4
6	1SL0304A00	1/2

## General purpose enclosures

Gemini - Components for distribution and mixed applications

### Kit for installing Tmax XT moulded-case circuit breakers

- For installing Tmax XT moulded-case circuit breakers in fixed version with front terminals
- Composed of a plate with special drilled holes and a protection panel with vertical slots that can be hinged on both sides and snap-on mounted (in compliance with reference Standards a tool must be used for removing the panel)
- Available for sizes 2-6
- Snap-on mounting onto uprights with the possibility of adjusting the plate depth

#### H 150 mm

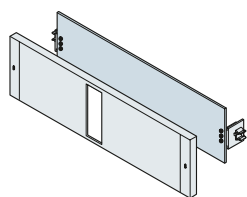

H 150 mm

Size of the switchboard	Code	Unit/Pack
2	1SL0373A00	1/4
3	1SL0373A00	1/4
4	1SL0374A00	1/4
5	1SL0374A00	1/4
6	1SL0375A00	1/2

#### H 300 mm

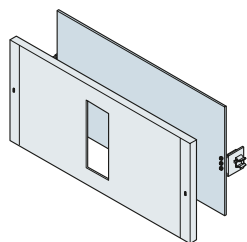

H 300 mm

Size of the switchboard	Code	Unit/Pack
2	1SL0376A00	1/4
3	1SL0376A00	1/4
4	1SL0377A00	1/4
5	1SL0377A00	1/4
6	1SL0378A00	1/2

## General purpose enclosures

Gemini - Components for distribution and mixed applications

### Kit selection

Size	Installation	XT1				XT2				XT3				XT4			
		3p	4p	3p D	4p D	3p	4p	3p D	4p D	3p	4p	3p D	4p D	3p	4p	3p D	4p D
1	D	■	■	■	■	■	■	■	■	■	■	■	■	■	■	■	■
	O1	■	■	■	■	■	■	■	■	■	■			■	■		
	T	■	■	■	■	■	■	■	■	■	■	■	■	■	■	■	■
2	D	■	■	■	■	■	■	■	■	■	■	■	■	■	■	■	■
	K1	■	■	■													
	K2		■	■	■						■	■	■	■			
	O1	■	■	■	■	■	■	■	■	■	■	■	■		■	■	■
	O2	■	■	■	■	■	■	■	■	■	■	■	■	■	■	■	■
	T	■	■	■	■	■	■	■	■	■	■	■	■	■	■	■	■
3	D	■	■	■	■	■	■	■	■	■	■	■	■	■	■	■	■
	K1	■	■	■													
	K2		■	■	■						■	■	■	■			
	O1	■	■	■	■	■	■	■	■	■	■	■	■		■	■	■
	O2	■	■	■	■	■	■	■	■	■	■	■	■	■	■	■	■
	T	■	■	■	■	■	■	■	■	■	■	■	■	■	■	■	■
4	D	■	■	■	■	■	■	■	■	■	■	■	■	■	■	■	■
	K1	■	■	■													
	K2		■	■	■						■	■	■	■			
	O1	■	■	■	■	■	■	■	■	■	■	■	■		■	■	■
	O2	■	■	■	■	■	■	■	■	■	■	■	■	■	■	■	■
	T	■	■	■	■	■	■	■	■	■	■	■	■	■	■	■	■
5	D	■	■	■	■	■	■	■	■	■	■	■	■	■	■	■	■
	K1	■	■	■													
	K2		■	■	■						■	■	■	■			
	O1	■	■	■	■	■	■	■	■	■	■	■	■		■	■	■
	O2	■	■	■	■	■	■	■	■	■	■	■	■	■	■	■	■
	T	■	■	■	■	■	■	■	■	■	■	■	■	■	■	■	■
6	D	■	■	■	■	■	■	■	■	■	■	■	■	■	■	■	■
	K1	■	■	■													
	K2		■	■	■						■	■	■	■			
	O1	■	■	■	■	■	■	■	■	■	■	■	■		■	■	■
	O2	■	■	■	■	■	■	■	■	■	■	■	■	■	■	■	■
	T	■	■	■	■	■	■	■	■	■	■	■	■	■	■	■	■

Caption

- D, installation on DIN rail
- K1, installation with Tmax kit H = 150 (holes made)
- K2, installation with Tmax kit H = 300 (holes made)
- O1, installation on modular plate (1 module, H = 150 mm)
- O2, installation on modular plate (2 modules, H = 300 mm)
- T, installation on total base plate



## General purpose enclosures

Gemini - Components for distribution and mixed applications

### Wiring kits

- composed of wiring duct in versions 25x60 mm and 40x60 mm (WxH, 8-12 mm slots) and Fix-O-Rapid
- Snap-on mounting on uprights with depth adjustment

### Wiring duct 25x60 mm

Size of the switchboard	Code	Unit/Pack
1	1SL0353A00	1/4
2	1SL0354A00	1/4
3	1SL0354A00	1/4
4	1SL0355A00	1/4
5	1SL0355A00	1/4
6	1SL0356A00	1/4

### Wiring duct 40x60 mm

Size of the switchboard	Code	Unit/Pack
1	1SL0360A00	1/4
2	1SL0361A00	1/4
3	1SL0361A00	1/4
4	1SL0362A00	1/4
5	1SL0362A00	1/4
6	1SL0363A00	1/4

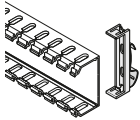
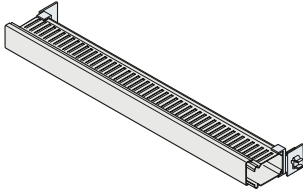

Wiring kit

## General purpose enclosures

### Gemini - Accessories

Gemini switchboards have the same accessories for both automation and distribution applications, ensuring maximum versatility and integration of functions. In particular, the ventilation and anti-condensation kits make it even safer for the devices to run, protecting them from the effects of heat and humidity while the wall brackets, pole mounting kit and pedestal make it easier to install the switchboards in any context.

Three different kinds of locks are supplied for the doors with which it is possible to replace the standard double bit model. The universal drill bit can be used to open the side branch connections. Module covers hide the unused modules of the DIN rail guaranteeing IP40 protection when the door is open in distribution and mixed configurations.



The standard locks supplied can be replaced by the version with ciphered key and handle or with square or triangular impression.



Gemini wall-mounted installation using the special mounting brackets.



The fact that Gemini switchboards can also be pole-mounted (see photo above) or mounted on a special pedestal (see photo at the side) makes them suitable for any application situation.

## General purpose enclosures

### Gemini - Accessories

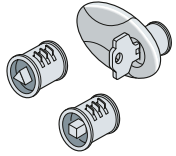

Locks

#### Locks

Available in three versions with ciphered key and handle, with triangular and square impressions.

Description	Code	Unit/Pack
Lock with Yale type ciphered key and handle	1SL0340A00	1/10
Lock with triangular impression	1SL0341A00	1/10
Lock with square impression	1SL0339A00	1/10
Tamper-proof locking kit (code 1SLO340A00 included)	1SL0458A00	1/10
Gemini standard lock	1SL0459A00	1/10



#### Locks for doors with handle

Description	Code	Unit/Pack
Yale Lock for door with handle	1SLM006600A0459	1/5
Ronis 455 lock for door with handle	1SLM006600A0460	1/5

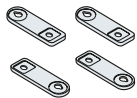

Plastic wall brackets

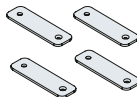

Stainless steel wall brackets

#### Mounting elements

Guarantee optimum wall, pole and floor mounting conditions.

Description	Code	Unit/Pack
Horizontal and vertical plastic wall brackets (4 pieces)*	1SL0342A00	1/10
Horizontal and vertical plastic wall brackets UL listed (4 pieces)	1SLM006600A0342	1/10
Horizontal and vertical stainless steel wall brackets (4 pieces)	1SL0401A00	1/10
Pole mounting kit for sizes 1 switchboards**	1SL0343A00	1/4
Pole mounting kit for sizes 2-3 switchboards**	1SL0344A00	1/4
Pole mounting kit for sizes 4-5 switchboards**	1SL0345A00	1/2
Pole mounting kit for size 6 switchboards**	1SL0346A00	1/2
IP43 Floor mounting pedestal for sizes 1-4	1SL0352A00	1/1

\* There are two types of inserts for adapting brackets to  $\varnothing 6$  e 8 mm fixing devices.

\*\* The kit includes two elements for fixing the upper and the lower part of the switchboard.

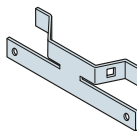

Pole mounting kit

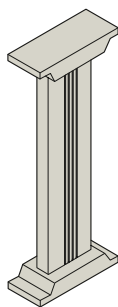

Floor mounting pedestal

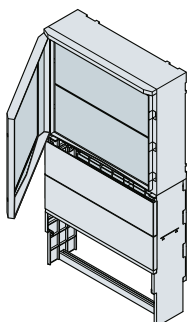

Pedestal

#### Pedestals

Allows the application of the Gemini switchboard to the ground without the need to prepare the construction of concrete footings or foundations when the pedestal is buried.

Description	Code	Unit/Pack
Pedestal Gemini size 4	1SL0464A00	1/1
Pedestal Gemini size 5	1SL0465A00	1/1
Pedestal Gemini size 6	1SL0466A00	1/1

## General purpose enclosures

### Gemini - Accessories

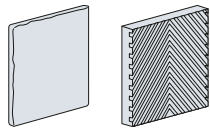

Ventilation kit

#### IP21/54 ventilation kits

- Composed of plastic grills and filter to ensure switchboard ventilation.
- Degree of protection without filter: IP21.
- Degree of protection with filter: IP54.
- Preassembled seal.

Description	Dimensions (mm)	Code	Unit/Pack
Grid + air flow kit	105x105	EN0105K	1/1
Grid + air flow kit (not suitable for size. 1)	150x150	EN0150K	1/1
Grid + air flow kit (not suitable for size. 1)	204x204	EN0204K	1/1

Note: screws not included; use 4 self lock screws 2,9x13 or ask for order code 1SL0384A00.

#### Base covers

For aesthetic as well as functional purposes, in particular for pedestal installations.

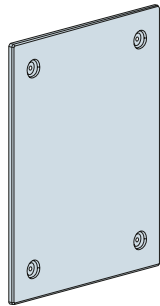

Base cover

Size of the switchboard	Code	Unit/Pack
1	1SL0385A00	1/4
2	1SL0386A00	1/4
3	1SL0387A00	1/2
4	1SL0388A00	1/2
5	1SL0389A00	1/2
6	1SL0390A00	1/2

#### Coupling kits

It follows the aesthetic outline of the boxes.

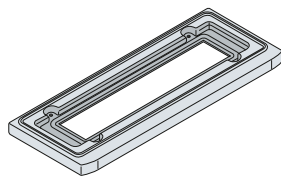

Coupling kit

Description	Code	Unit/Pack
Vertical coupling kit for sizes 2-3 switchboards	1SL0413A00	1/2
Vertical coupling kit for sizes 4 switchboards	1SL0414A00	1/2
Vertical coupling kit for sizes 5 switchboards	1SL0415A00	1/2
Vertical coupling kit for sizes 6 switchboards	1SL0416A00	1/2

## General purpose enclosures

### Gemini - Accessories

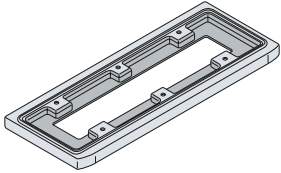

Bottom base

#### Bottom bases H 30

For fixing the Gemini switchboard directly to the floor.

Description	Code	Unit/Pack
Bottom base for size 2-3 switchboards	1SL0423A00	1/2
Bottom base for size 4 switchboards	1SL0424A00	1/2
Bottom base for size 5 switchboards	1SL0425A00	1/2
Bottom base for size 6 switchboards	1SL0426A00	1/2

#### Fixed frames

- In combination with bottom base H 30
- For fixing onto poured concrete floors and bases.

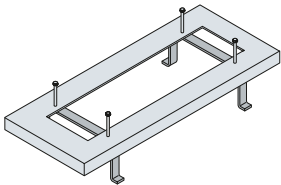

Fixed frame

Description	Code	Unit/Pack
Fixed frame for size 2-3 switchboards	1SL0433A00	1/2
Fixed frame for size 4 switchboards	1SL0434A00	1/2
Fixed frame for size 5 switchboards	1SL0435A00	1/2
Fixed frame for size 6 switchboards	1SL0436A00	1/2

#### Integral covers

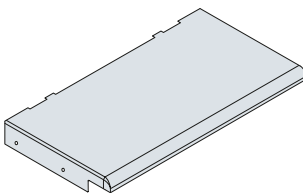

Integral cover

Description	Code	Unit/Pack
Integral cover for size 1 switchboard	1SL0451A00	1/1
Integral cover for size 2-3 switchboard	1SL0452A00	1/1
Integral cover for size 4 switchboard	1SL0454A00	1/1
Integral cover for size 5 switchboard	1SL0455A00	1/1
Integral cover for size 6 switchboard	1SL0456A00	1/1

#### Horizontal Kits

Kit for a proper opening of switchboard upward.

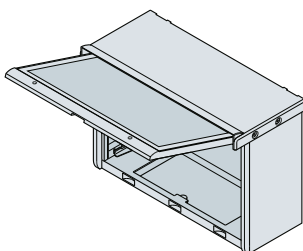

Horizontal Kit Gemini

Description	Code	Unit/Pack
Horizontal Kit Gemini size 3	1SL0470A00	1/1
Horizontal Kit Gemini size 4	1SL0471A00	1/1
Horizontal Kit Gemini size 5	1SL0472A00	1/1

## General purpose enclosures

### Gemini - Accessories

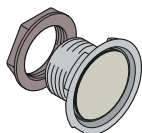

Base socket

#### Anti-condensation kits

- Kit in special material to prevent condensation from forming inside the switchboard: it include **GORE™ MEMBRANE VENTING**
- Impermeable to water (pressure): 0.6 bar / 60 sec.
- Air flow: 400 ml/min. (dp = 70 mbar)
- 1 kit for sizes 1-2, 2 kits for sizes 3-4 and 3 kits for sizes 5-6 are recommended to guarantee adequate dissipation; in any case the number of kits to be installed depend on the number and type of devices installed inside the switchboard.
- IP66

Description	Code	Unit/Pack
Anti-condensation kit	1SL0351A00	1/6

#### Other accessories

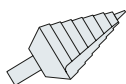

Universal drill bit

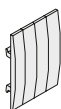

Module covers

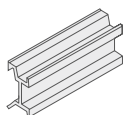

Spacer

Description	Code	Unit/Pack
Universal drill bit	12894	1/30
Module covers in RAL 7035 grey, 4 modules	12863	25/300
Plastic spacer for installing modular devices and moulded-case circuit breakers at the same depth	12851	10/60
Small bag plate mounting kit	1SL0383A00	1/10
Small bag for ventilation kit	1SL0384A00	10/50

#### Temperature management

##### IP20 heater

Description	Dimensions (mm)			Code	Package/ No. of pieces
	H	W	D		
Anti-condensation heater 30W, 110-240 Vac-dc	115	42	42	VA7930	1/1
Anti-condensation heater 50W, 110-240 Vac-dcc	165	42	42	VA7950	1/1
Anti-condensation heater 75W, 110-240 Vac-dc	210	42	42	VA7975	1/1
Anti-condensation heater 100W, 110-240 Vac-dc	165	42	51	VA7910	1/1
Anti-condensation heater 150W, 110-240 Vac-dc	146	82	51	VA7915	1/1
Anti-condensation heater with fan 300W, 230 Vac-dc	148	82	91	VA8300	1/1

For technical details, see page 50.

# General purpose enclosures

## Gemini - Fast selection table

### Basic configuration

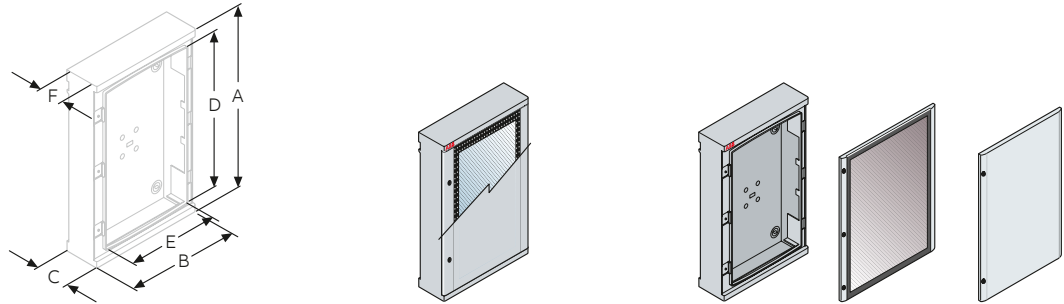

Size	No. of installable DIN modules (mod. x row)	No. of vertical mod. (H=150 mm)	External dimensions			Internal dimensions			Complete switchboard		Box	Door	
			A	B	C	D	E	F	Transparent door	Opaque door		Transparent	Opaque
1	24 (12x2)	2	400	335	210	300	250	180	1SL0211A00	1SL0201A00	1SL0221A00	1SL0241A00	1SL0231A00
2	54 (18x3)	3	550	460	260	450	375	230	1SL0212A00	1SL0202A00	1SL0222A00	1SL0242A00	1SL0232A00
3	72 (18x4)	4	700	460	260	600	375	230	1SL0213A00	1SL0203A00	1SL0223A00	1SL0243A00	1SL0233A00
4	96 (24x4)	4	700	590	260	600	500	230	1SL0214A00	1SL0204A00	1SL0224A00	1SL0244A00	1SL0234A00
5	120 (24x5)	5	855	590	360	750	500	330	1SL0215A00	1SL0205A00	1SL0225A00	1SL0245A00	1SL0235A00
6	216 (36x6)	6	1005	840	360	900	750	330	1SL0216A00	1SL0206A00	1SL0226A00	1SL0246A00	1SL0236A00

### Components for automation

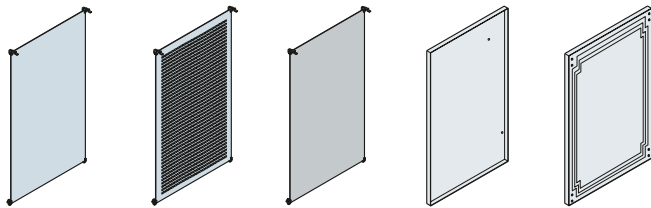

Size	Base plate			Inner door	
	Blank	Drilled	Insulating	Former version	New version
1	1SL0259A00	1SL0275A00	1SL0267A00	1SL0251A00	-
2	1SL0260A00	1SL0276A00	1SL0268A00	1SL0252A00	-
3	1SL0261A00	1SL0277A00	1SL0269A00	-	1SL0253A00
4	1SL0262A00	1SL0278A00	1SL0270A00	-	1SL0254A00
5	1SL0263A00	1SL0279A00	1SL0271A00	-	1SL0255A00
6	1SL0264A00	1SL0280A00	1SL0272A00	-	1SL0256A00

### Accessories for distribution

Wiring ducts	Fix-O-Rapid
Check the ABB Library	

## General purpose enclosures

### Gemini - Fast selection table

#### Components for automation

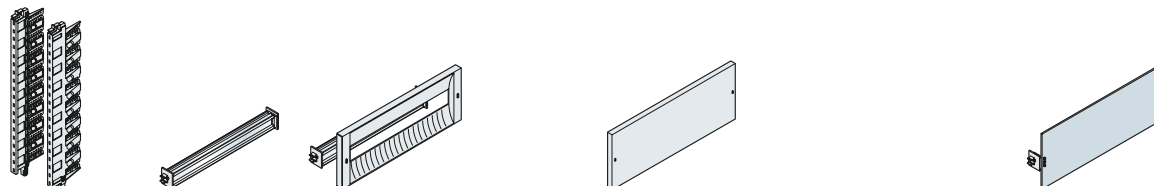

Size	Uprights	DIN rail	Drilled panel		Blank panel			Modular plate	
			H=150 mm	H=225 mm	H=75 mm	H=150mm	H=300 mm	H=150 mm	H=300 mm
1	1SL0283A00	1SL0290A00	1SL0307A00	-	1SL0318A00	1SL0324A00	1SL0330A00	1SL0296A00	-
2	1SL0284A00	1SL0291A00	1SL0308A00	1SL0313A00	1SL0319A00	1SL0325A00	1SL0331A00	1SL0297A00	1SL0302A00
3	1SL0285A00	1SL0291A00	1SL0308A00	1SL0313A00	1SL0319A00	1SL0325A00	1SL0331A00	1SL0297A00	1SL0302A00
4	1SL0285A00	1SL0292A00	1SL0309A00	1SL0314A00	1SL0320A00	1SL0326A00	1SL0332A00	1SL0298A00	1SL0303A00
5	1SL0286A00	1SL0292A00	1SL0309A00	1SL0314A00	1SL0320A00	1SL0326A00	1SL0332A00	1SL0298A00	1SL0303A00
6	1SL0287A00	1SL0293A00	1SL0310A00	1SL0315A00	1SL0321A00	1SL0327A00	1SL0333A00	1SL0299A00	1SL0304A00

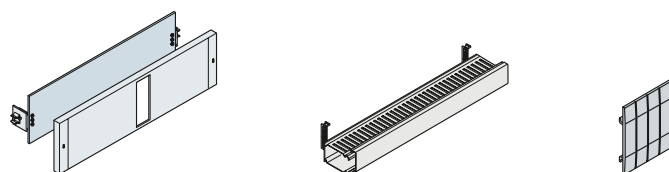

#### Accessories for distribution

Size	Kit for Tmax XT		x-O-Rapid kit with wiring duct		Module covers RAL 7035
	H. 150 mm	H. 300 mm	25x60 mm	40x60 mm	
1	-	-	1SL0353A00	1SL0360A00	12863
2	1SL0373A00	1SL0376A00	1SL0354A00	1SL0361A00	
3	1SL0373A00	1SL0376A00	1SL0354A00	1SL0361A00	
4	1SL0374A00	1SL0377A00	1SL0355A00	1SL0362A00	
5	1SL0374A00	1SL0377A00	1SL0355A00	1SL0362A00	
6	1SL0375A00	1SL0378A00	1SL0356A00	1SL0363A00	



## General purpose enclosures

### Gemini - Fast selection table

#### Accessories common to the whole range

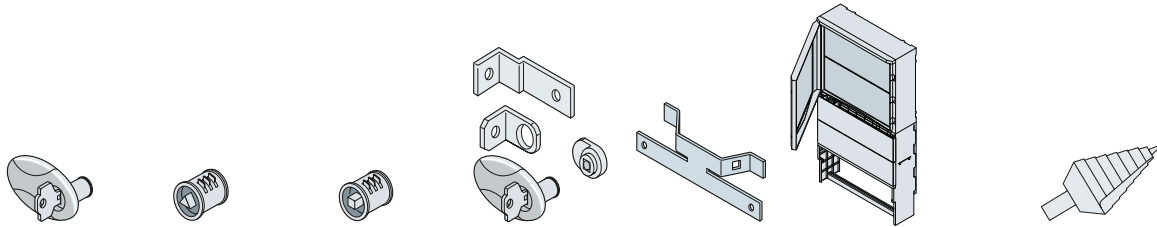

Size	Lock with handle	Lock with triangular impression	Lock with square impression	Anti tampering locking kit	Pole installation kit	Pedestal	Universal drill bit	Base mounting kit for metal and insulated plates
1	1SL0340A00	1SL0341A00	1SL0339A00	1SL0458A00	1SL0343A00	-	12894	1SL0383A00
2					1SL0344A00	-		
3					1SL0344A00	-		
4					1SL0345A00	1SL0464A00		
5					1SL0345A00	1SL0465A00		
6					1SL0346A00	1SL0466A00		

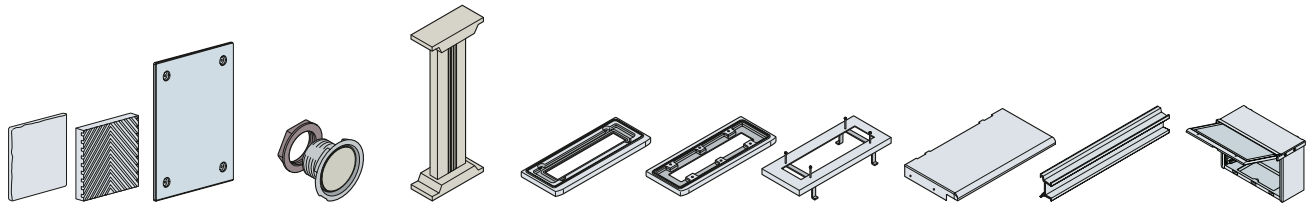

Size	Ventilation kit	Base cover	Anti condensation kit	Floor pedestal	Coupling kit	Bottom base H 30	Fixed frame	Integral cover	Depth adapter	Horizontal kit
1	Check the ABB Library	1SL0385A00	1SL0351A00	1SL0352A00	-	-	-	1SL0451A00	12851	-
2		1SL0386A00			1SL0413A00	1SL0423A00	1SL0433A00	1SL0452A00		1SL0470A00
3		1SL0387A00			1SL0413A00	1SL0423A00	1SL0433A00	1SL0452A00		1SL0471A00
4		1SL0388A00			1SL0414A00	1SL0424A00	1SL0434A00	1SL0454A00		
5		1SL0389A00		-	1SL0415A00	1SL0425A00	1SL0435A00	1SL0455A00		1SL0472A00
6		1SL0390A00		-	1SL0416A00	1SL0426A00	1SL0436A00	1SL0456A00		

## General purpose enclosures

### Gemini - Fast selection table

#### Door with handle



#### Transparent door with handle

Size	Box dimensions WxHxD (mm)	Code
3	460x700x260	1SLM006600A0243
4	590x700x260	1SLM006600A0244
5	590x855x360	1SLM006600A0245
6	840x1005x360	1SLM006600A0246

#### Opaque door with handle

Size	Box dimensions WxHxD (mm)	Code
3	460x700x260	1SLM006600A0233
4	590x700x260	1SLM006600A0234
5	590x855x360	1SLM006600A0235
6	840x1005x360	1SLM006600A0236

#### Accessories



#### Lock with handle

Description	Code
Yale Lock for door with handle	1SLM006600A0459
Ronis 455 lock for door with handle	1SLM006600A0460

#### Mounting elements

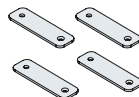
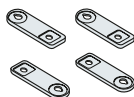

#### Horizontal and vertical plastic wall brackets (4 pieces)\*

1SL0342A00

#### Horizontal and vertical stainless steel wall brackets (4 pieces)

1SL0401A00

\* There are two types of inserts for adapting brackets to  $\varnothing$  6 e 8 mm fixing devices.

## General purpose enclosures

### Gemini - Configurations examples

The selection of components for the configuration of Gemini switchboards depends on the space available and the type of application. Two examples for each size are given below.

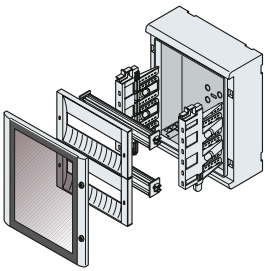

#### Size 1

Distribution	
Box + transparent door	1SL0211A00
Uprights	1SL0283A00
1-mod. drilled panel + DIN rail	1SL0307A00 (x2)

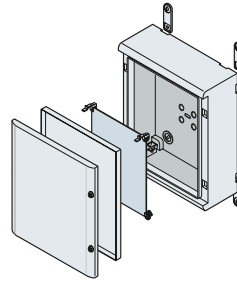

Automation	
Box + opaque door	1SL0201A00
Metal base plate	1SL0259A00
Inner door	1SL0251A00
Wall-mounting brackets	1SL0342A00

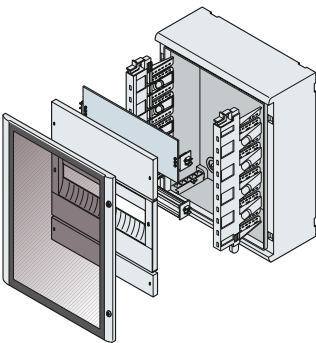

#### Size 2

Distribution/Mixed	
Box + transparent door	1SL0212A00
Uprights	1SL0284A00
Modular plate 1 mod.	1SL0297A00
Blank panel 1 mod.	1SL0325A00
Drilled panel 1+1/2 mod. + DIN rail	1SL0313A00
Blank panel 1/2 mod.	1SL0319A00
Module covers	12863

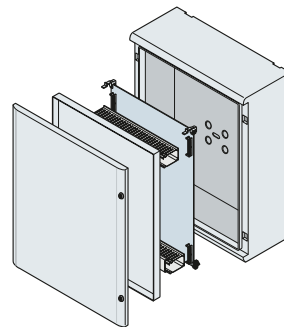

Automation	
Box + opaque door	1SL0202A00
Metal base plate	1SL0260A00
Inner door	1SL0252A00
Wiring duct	Check the ABB Library
Fix-O-Rapid	Check the ABB Library

## General purpose enclosures

### Gemini - Configurations examples

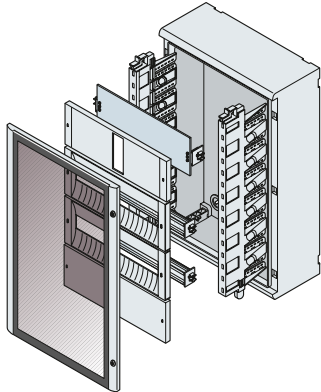

#### Size 3

Distribution/Mixed	
Box + transparent door	1SL0213A00
Uprights	1SL0285A00
Kit for Tmax	1SL0336A00
Drilled panel 1 mod. + DIN rail	1SL0308A00(x2)
DIN rail	1SL0291A00
Blank panel 1 mod.	1SL0325A00

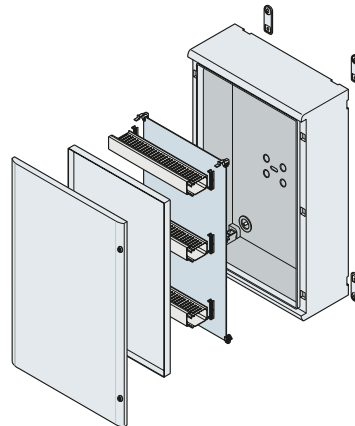

Automation	
Box + opaque door	1SL0203A00
Base insulating plate	1SL0269A00
Inner door	1SL0253A00
Wiring duct	Check the ABB Library
Fix-O-Rapid	Check the ABB Library
Wall-mounting brackets	1SL0342A00

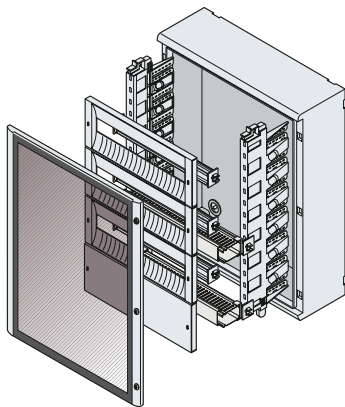

#### Taglia 4

Distribution/Mixed	
Box + transparent door	1SL0214A00
Uprights	1SL0285A00
Drilled panel 1 mod. + DIN rail	1SL0309A00 (x3)
Blank panel 1 mod.	1SL0326A00
Wiring kit 25x60 mm	1SL0355A00 (x2)
DIN rail	1SL0292A00
Module covers	12863

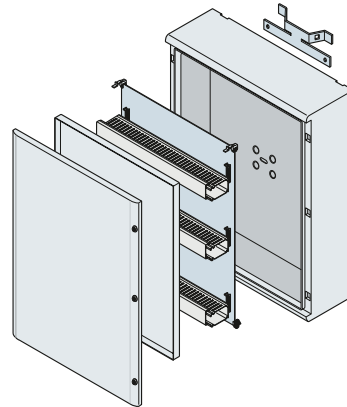

Automation	
Box + opaque door	1SL0204A00
Metal base plate	1SL0262A00
Inner door	1SL0254A00
Wiring duct	Check the ABB Library
Fix-O-Rapid	Check the ABB Library
Fixing on pole kit	1SL0345A00

## General purpose enclosures

### Gemini - Configurations examples

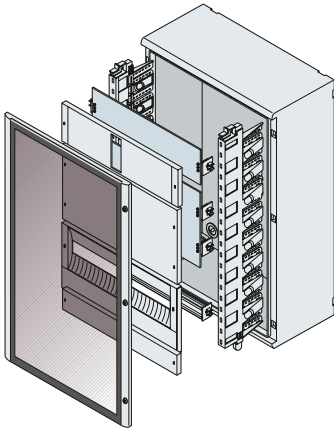

#### Size 5

Distribution/Mixed	
Box + transparent door	1SL0215A00
Uprights	1SL0286A00
Kit for Tmax	1SL0337A00
Modular plate 2 mod.	1SL0303A00
Blank panel 2 mod.	1SL0332A00
Drilled panel 1+1/2 mod.	1SL0314A00
Blank panel 1/2 mod.	1SL0320A00
Module covers	12863

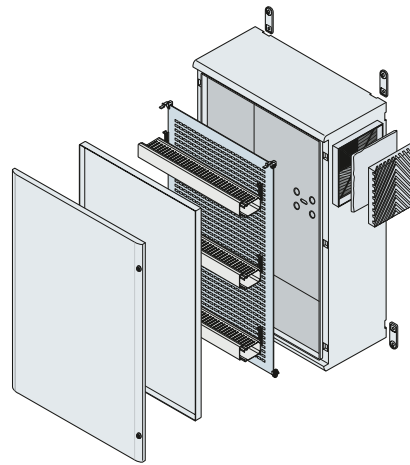

Automation	
Box + opaque door	1SL0205A00
Drilled base plate	1SL0279A00
Inner door	1SL0255A00
Wiring duct	Check the ABB Library
Fix-O-Rapid	Check the ABB Library
Wall-mounting brackets	1SL0342A00
Ventilation kit	1SL0350A00

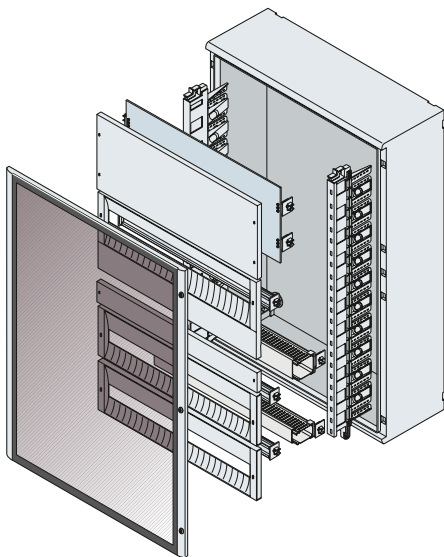

#### Size 6

Distribution/Mixed	
Box + transparent door	1SL0216A00
Uprights	1SL0287A00
Modular plate 2 mod.	1SL0304A00
Blank panel 2 mod.	1SL0333A00
Drilled panel 1+1/2 mod.	1SL0315A00
Blank panel 1/2 mod.	1SL0321A00
Drilled panel 1 mod.	1SL0310A00 (x2)
Wiring kit 25x60 mm	1SL0356A00
Wiring kit 40x60 mm	1SL0363A00

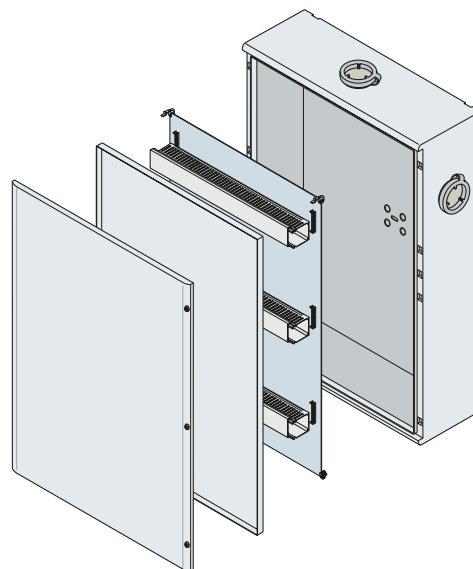

Automation	
Box + opaque door	1SL0206A00
Metal base plate	1SL0264A00
Inner door	1SL0256A00
Wiring duct	Check the ABB Library
Fix-O-Rapid	Check the ABB Library
Triangular lock	1SL0341A00 (x3)
Anti-condensation kit	1SL0351A00 (x3)

---

## General purpose enclosures technical details

### Gemini - Compliance with standards and technical characteristics

#### Reference Standards

Standard IEC 62208 (“Empty enclosures for low voltage switch-gear and control gear assemblies. General requirements”), that has implemented at an international level the Standard EN 50298, presently EN 62208, is the prescriptive reference for Gemini switchboards.

The object of Standard CEI EN 50298 is to formulate definitions, classifications, characteristics and test prescriptions for cases designed to be used as part of protection and operating equipment (switchboards) in compliance with the Standards of the EN 61439 series, that have a maximum rated voltage of 1000 V in alternating current for maximum frequencies of 1000 Hz or 1500 V in direct current and are suitable for general use in both internal and external applications.

The Standard applies to empty enclosures, before the user

has installed protection and operating devices inside them. The Standard does not apply to enclosures with structural and functional characteristics that make them subject to other prescriptions (e.g. cases for domestic installations and the like). In this case Standards IEC 60670 – CEI 23-48 (“General requirements for enclosures for accessories for household and similar fixed electrical installations”) and CEI 23-49 (“Enclosures for accessories for household and similar fixed electrical installations. Part 2: particular requirements for enclosures for protection devices and accessories dissipating a considerable power in normal use”) apply. On the basis of the indications of the ABB SACE technical characteristics’ table, the installer may have to certify compliance with Standards CEI 23-51 – EN 61439 – CEI 17-13-1 (“Part 1: standard equipment subject)

## General purpose enclosures technical details

### Gemini - Compliance with standards and technical characteristics

**Gemini switchboards features table**

Size	1	2	3	4	5	6
Gemini with transparent door	1SL0211A00	1SL0212A00	1SL0213A00	1SL0214A00	1SL0215A00	1SL0216A00
Gemini with opaque door	1SL0201A00	1SL0202A00	1SL0203A00	1SL0204A00	1SL0205A00	1SL0206A00
External dimensions WxHxD (mm)	335x400x210	460x550x260	460x700x260	590x700x260	590x855x360	840x1005x360
Internal dimensions WxHxD (mm)	250x300x180	375x450x230	375x600x230	500x600x230	500x750x330	750x900x330
IP degree	IP66	IP66	IP66	IP66	IP66	IP66
Double isolation	Si	Si	Si	Si	Si	Si
IK degree	10	10	10	10	10	10
GWT (°C)	750	750	750	750	750	750
Operating temperature	-25 °C ... +100 °C	-25 °C ... +100 °C	-25 °C ... +100 °C	-25 °C ... +100 °C	-25 °C ... +100 °C	-25 °C ... +100 °C
No. of DIN modules	24 (12x2)	54 (18x3)	72 (18x4)	96 (24x4)	120 (24x5)	216 (36x6)
No. of vertical modules (H=150 mm)	2	3	4	4	5	6
Material	Thermoplastic	Thermoplastic	Thermoplastic	Thermoplastic	Thermoplastic	Thermoplastic
Color	Gray RAL7035	Gray RAL7035	Gray RAL7035	Gray RAL7035	Gray RAL7035	Gray RAL7035
Fast wiring system	Unifix L	Unifix L	Unifix L	Unifix L	Unifix L	Unifix L
No. of locks	2	2	2	2	3	3
Rated frequency	50-60 Hz	50-60 Hz	50-60 Hz	50-60 Hz	50-60 Hz	50-60 Hz
<b>STANDARD CEI 23-51<sup>(1)</sup></b>						
- Max. dispersible power <sup>(2)</sup>	45 W	72 W	85 W	102 W	156 W	248 W
<b>STANDARD CEI EN 61439</b>						
<b>Over-temperature (par. 8.2.1)<sup>(3)</sup></b>						
- Max. dispersible power with over-temperature of 25 °C	40 W	65 W	77 W	91 W	133 W	205 W
- Max. dispersible power with over-temperature of 30 °C	45 W	72 W	85 W	102 W	156 W	248 W
- Max. dispersible power with over-temperature of 35 °C	52 W	85 W	100 W	121 W	187 W	299 W
- Max. dispersible power with over-temperature of 40 °C	62 W	100 W	118 W	143 W	221 W	355 W
<b>Impulse withstand (par. 8.2.2)</b>						
- Rated service voltage <sup>(4)</sup>	≤ 800 V	≤ 800 V	≤ 800 V	≤ 800 V	≤ 800 V	≤ 800 V
- Rated impulse withstand voltage	8 kV	8 kV	8 kV	8 kV	8 kV	8 kV

<sup>(1)</sup> Limits of applicability of the standard CEI 23-51

The standard may be applied only when the wired switchboard meets all the following conditions:

- fixed installation with average ambient temperature up to 25 °C, occasionally up to 35 °C;
- alternate current with rated voltage up to 440 V;
- input rated current up to 125 A;
- assumed short circuit rated current up to 10 kA or limiting current devices protection with limited current up to 15 kA at their rated breaking capacity.

<sup>(2)</sup> Maximum dissipation power data was obtained following the indications of Standard CEI 23-49, with a temperature difference of Dt=30 °C.

<sup>(3)</sup> Note to paragraph 8.2.1 of Standard CEI EN 61439-1

The table gives the thermal dissipation values of Gemini switchboards when they are wall-mounted. The dispersible power figures (in Watts) vary according to the overtemperature allowed in the accessible parts of the switchboard and must be compared with the total amount of power dissipated by all the components installed inside the switchboard taking into due account the factor of contemporaneity.

<sup>(4)</sup> Rated service voltage according to CEI EN 61439-1 1000V AC and 1500V DC

## General purpose enclosures technical details

### Gemini - IP degree of protection

As indicated in the following table, the IP degree of protection is expressed by two characteristic numbers depending on the behavior of the product to which it refers according to the prescriptions of CEI 70-1 and IEC 529 Standards.

#### First number: protection against the penetration of solid bodies

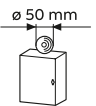
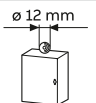
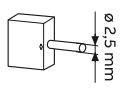
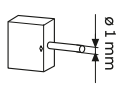
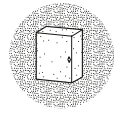
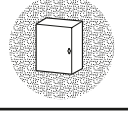
IP		
0		No protection
1		Protection against the penetration of solid bodies with a diameter of over 50mm
2		Protection against the penetration of solid bodies with a diameter of over 12 mm or a length of over 80 mm
3		Protection against the penetration of solid bodies with a diameter or thickness of over 2,5 mm
4		Protection against the penetration of solid bodies with a diameter or thickness of over 1,0 mm
5		Protection against the penetration of dusts
6		Total protection against the penetration of dusts

1<sup>st</sup> number defined by Standards CEI 70-1 – IEC 60529

With IP66 degree of protection, Gemini switchboards are totally protected against the penetration of dusts and sprays of seawater.

#### Second number: protection against the penetration of water

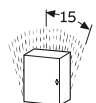
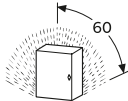
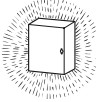
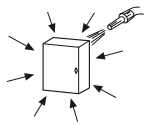
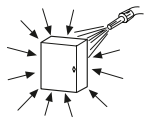
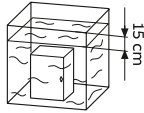
IP		
0		No protection
1		Protection against the penetration of drops of water falling vertically
2		Protection against the penetration of drops of water falling at an angle of up to 15° from vertical
3		Protection against the penetration of drops of water falling at an angle of up to 60° from vertical
4		Protection against the penetration of splashes of water from all directions
5		Protection against the penetration of water sprayed by a hose from all directions
6		Protection against the penetration of sea water
7		Protection against the penetration of water during temporary immersion
8		Protection against the penetration of water during continual immersion

2<sup>nd</sup> number defined by Standards CEI 70-1 - IEC 60529.



## General purpose enclosures technical details

### Gemini - IK degree of resistance to impacts

The IK degree is expressed in Joules in compliance with Standard CEI EN 50102.

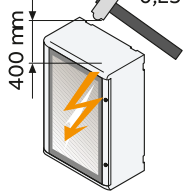
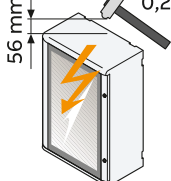
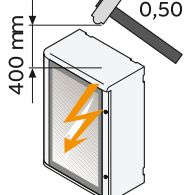
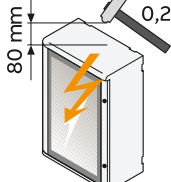
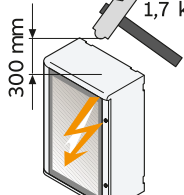
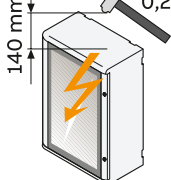
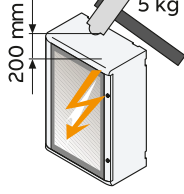
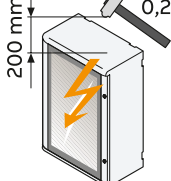
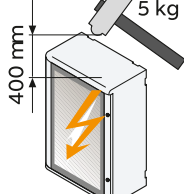
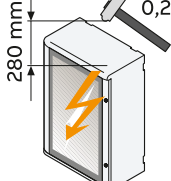
IK 0		No protection against impacts	IK 06		Resistance to impacts with impact energy up to 1,00 J
IK 01		Resistance to impacts with impact energy up to 0,150 J	IK 07		Resistance to impacts with impact energy up to 2,00 J
IK 02		Resistance to impacts with impact energy up to 0,200 J	IK 08		Resistance to impacts with impact energy up to 5,00 J
IK 03		Resistance to impacts with impact energy up to 0,350 J	IK 09		Resistance to impacts with impact energy up to 10,00 J
IK 04		Resistance to impacts with impact energy up to 0,500 J	IK 10		Resistance to impacts with impact energy up to 20,00 J
IK 05		Resistance to impacts with impact energy up to 0,700 J			

## General purpose enclosures technical details

### Gemini - Double insulation and self-extinguishing tests

#### Double insulation

Double insulation guarantees that Gemini is protected against indirect contacts on condition that the manufacturer's instructions are observed when carrying out mounting

and wiring operations on the switchboard and that the appropriate accessories are used (e.g. screw-cover caps). Double insulation is indicated by the graphic symbol 

#### Self-extinguishing tests

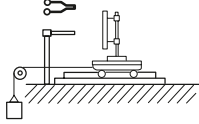
Test text	Equipment required	Compliance with Standards	Purpose	Test results of the test	Test conditions		
					Heat source	Test period	Characteristic elements
Glow-wire test		IEC 695-2-1 CEI 50-11	To assess the danger of fire by simulating thermal stresses produced by heat sources or by ignition (e.g. glowing elements, resistances overloaded for short intervals)	If a flame is generated, it must go out within 30 seconds of removing the glow wire. The test is conducted at temperatures of: - 650 °C - 750 °C - 850 °C - 960 °C	Glow wire ø 4 mm	30 sec.	Assessment of the time it takes for the flame to go out

## General purpose enclosures technical details

### Gemini - Resistance to chemical agents

#### Resistance to chemical agents

The behavior of Gemini switchboards in the presence of chemical agents is indicated in the table with the symbols:

Cold water	■
Hot water	■
Sulfuric acid 50%	■
Hydrochloric acid 36%	■
Acetic acid 60%	■
Benzol	▲
Gasoline	▲
Acetone	■
Ethyl alcohol	■
Ammonia	■
Dichloromethane	▲
Diesel oil - naphtha	▲
Mineral oils and greases	■
Food oils and greases	■
Perchloroethylene	▲
Trichlorethene	▲
Ethylether	■
Toluene	▲
Methanol	■
Wine	■
Fruit juices	■
Laundry lye	■
Detergents	■

Caption:

- high resistance
- ▲ limited resistance

## General purpose enclosures technical details

### Gemini - Integration with ABB products

#### Installation of Tmax XT moulded-case circuit breakers

The table indicates the type of installation required for the different versions of Tmax XT moulded-case circuit breakers in Gemini switchboards.

Before carrying out wiring operations check compliance with Standards on the basis of the technical characteristics of the switchboard and circuit breaker (CEI EN 60439-1).

Size	Installation	XT1				XT2				XT3				XT4			
		3p	4p	3p D	4p D	3p	4p	3p D	4p D	3p	4p	3p D	4p D	3p	4p	3p D	4p D
1	D	■	■	■	■	■	■	■	■	■	■	■	■	■	■	■	■
	O1	■	■	■	■	■	■	■	■	■	■			■	■		
	T	■	■	■	■	■	■	■	■	■	■	■	■	■	■	■	■
2	D	■	■	■	■	■	■	■	■	■	■	■	■	■	■	■	■
	K1	■	■	■													
	K2		■	■	■					■	■	■	■				
	O1	■	■	■	■	■	■	■	■	■	■	■		■	■	■	■
	O2	■	■	■	■	■	■	■	■	■	■	■	■	■	■	■	■
	T	■	■	■	■	■	■	■	■	■	■	■	■	■	■	■	■
3	D	■	■	■	■	■	■	■	■	■	■	■	■	■	■	■	■
	K1	■	■	■													
	K2		■	■	■					■	■	■	■				
	O1	■	■	■	■	■	■	■	■	■	■	■		■	■	■	
	O2	■	■	■	■	■	■	■	■	■	■	■	■	■	■	■	■
	T	■	■	■	■	■	■	■	■	■	■	■	■	■	■	■	■
4	D	■	■	■	■	■	■	■	■	■	■	■	■	■	■	■	■
	K1	■	■	■													
	K2		■	■	■					■	■	■	■				
	O1	■	■	■	■	■	■	■	■	■	■	■		■	■	■	■
	O2	■	■	■	■	■	■	■	■	■	■	■	■	■	■	■	■
	T	■	■	■	■	■	■	■	■	■	■	■	■	■	■	■	■
5	D	■	■	■	■	■	■	■	■	■	■	■	■	■	■	■	■
	K1	■	■	■													
	K2		■	■	■					■	■	■	■				
	O1	■	■	■	■	■	■	■	■	■	■	■		■	■	■	
	O2	■	■	■	■	■	■	■	■	■	■	■	■	■	■	■	■
	T	■	■	■	■	■	■	■	■	■	■	■	■	■	■	■	■
6	D	■	■	■	■	■	■	■	■	■	■	■	■	■	■	■	■
	K1	■	■	■													
	K2		■	■	■					■	■	■	■				
	O1	■	■	■	■	■	■	■	■	■	■	■		■	■	■	■
	O2	■	■	■	■	■	■	■	■	■	■	■	■	■	■	■	■
	T	■	■	■	■	■	■	■	■	■	■	■	■	■	■	■	■

#### Caption

- D, installation on DIN rail
- K1, installation with Tmax kit H = 150 (holes made)
- K2, installation with Tmax kit H = 300 (holes made)
- O1, installation on modular plate (1 module, H = 150 mm)
- O2, installation on modular plate (2 modules, H = 300 mm)
- T, installation on total base plate

## General purpose enclosures technical details

### Gemini - Disposal instructions

#### Information about how to dispose of Gemini switchboards when they reach the end of their life

Instructions are given below about the procedures to adopt when disposing of Gemini switchboards at the end of their life cycle.



The text is drafted in the form of a table referring to Standard CEI 308-1 "Information table concerning the end of life of electric and electronic products and a compilation guide", 2002 -04, ed. 1, pamphlet number 308-1 6454.

#### Section I – Global product specification

Name	Type of product			External dimensions WxHxD (mm)
Size	With transparent door	With opaque door	Rated weight (kg)	
1	1SL0211A00	1SL0201A00	4,3	335x400x210
2	1SL0212A00	1SL0202A00	7,9	460x550x260
3	1SL0213A00	1SL0203A00	9,5	460x700x260
4	1SL0214A00	1SL0204A00	12,0	590x700x260
5	1SL0215A00	1SL0205A00	17,8	590x855x360
6	1SL0216A00	1SL0206A00	21,1	840x1005x360

#### Section II – Global product table

General code: CER 17 02 03 plastic (more than 95% of the product's weight)

Part (P1, P2 ecc.)/ Component number	Diagram	Quantity % over total weight	Material description	Symbol	Dangerousness (Yes/No)	CER code	
P1/BOX		~ 80%	Polypropylene	 >PP<	No	17 02 03	
P2/ROOF			Polycarbonate	 >PC<	No	17 02 03	
P3/DOOR			~ 20%	Steel	 >PC<	No	17 04 05
P4/ACCESSORIES			< 5%	Brass	-	No	17 04 01
P5/ACCESSORIES			< 5%	Polypropylene	-	No	17 02 03

# General purpose enclosures technical details

## Gemini - Overall Dimensions – Basic configuration

### Front view

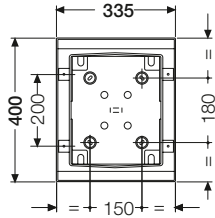

**Size 1**

1SL0201A00 - 1SL0211A00 - 1SL0221A00

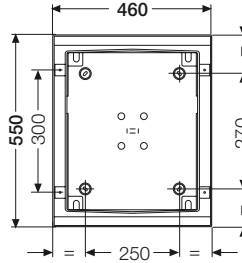

**Size 2**

1SL0202A00 - 1SL0212A00 - 1SL0222A00

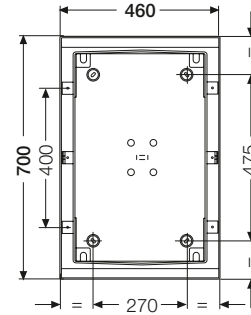

**Size 3**

1SL0203A00 - 1SL0213A00 - 1SL0223A00

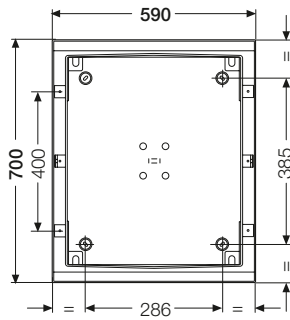

**Size 4**

1SL0204A00 - 1SL0214A00 - 1SL0224A00

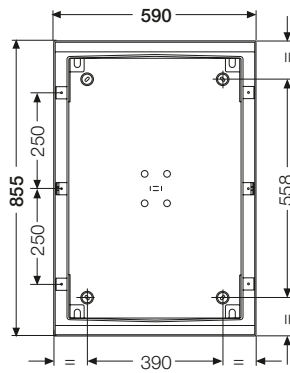

**Size 5**

1SL0205A00 - 1SL0215A00 - 1SL0225A00

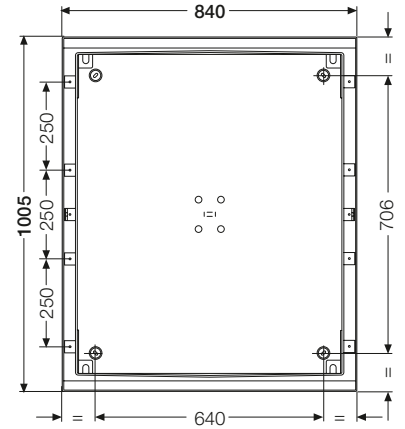

**Size 6**

1SL0206A00 - 1SL0216A00 - 1SL0226A00

### Top view

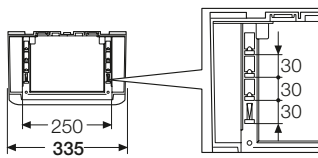

**Size 1**

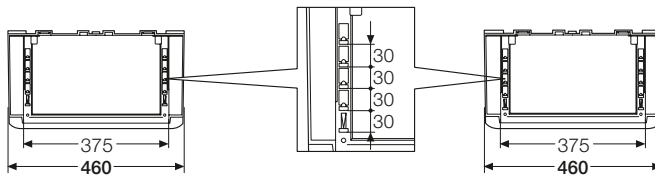

**Size 2**

**Size 3**

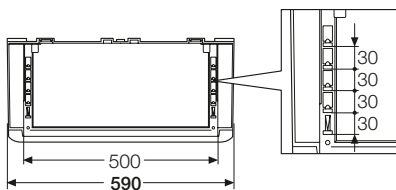

**Size 4**

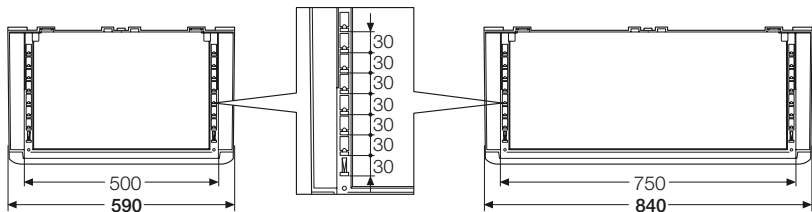

**Size 5**

**Size 6**

Measurements are expressed in millimeters.

## General purpose enclosures technical details

### Gemini - Overall Dimensions – Basic configuration

#### Side view

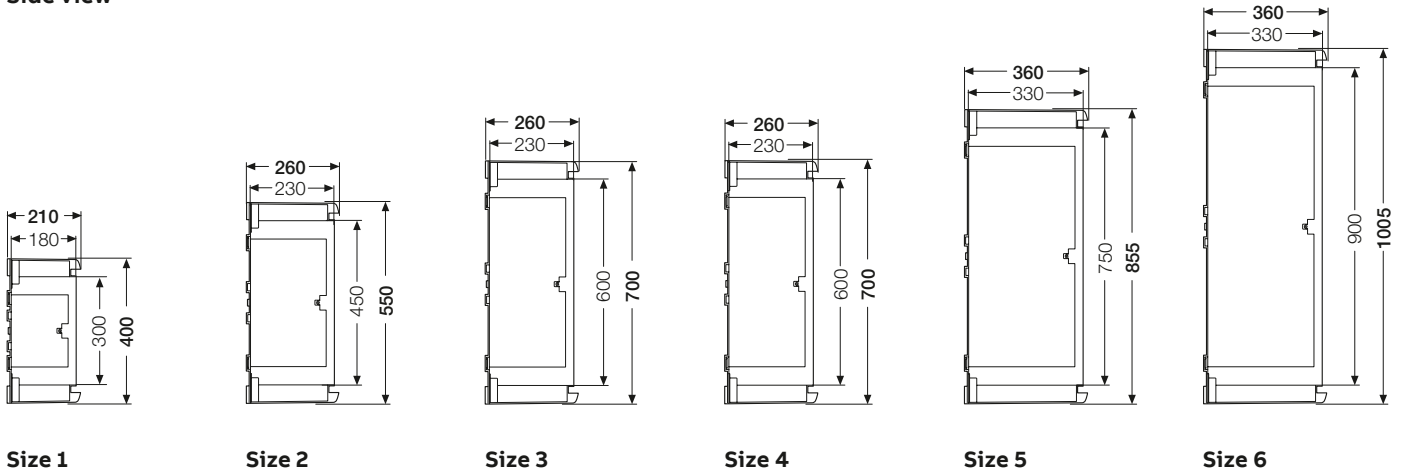

#### Installation with plastic brackets

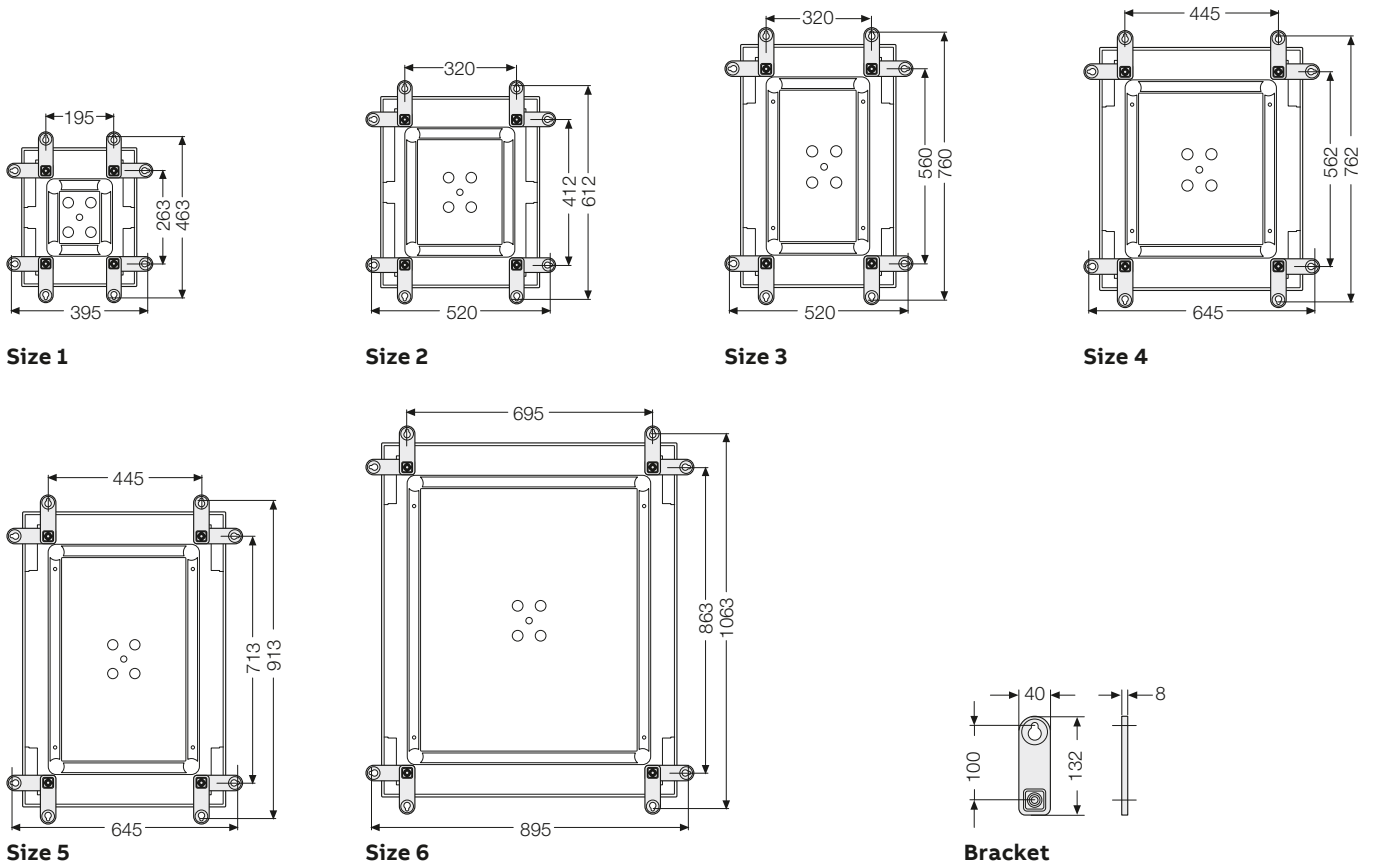

Measurements are expressed in millimeters.

## General purpose enclosures technical details

### Gemini - Overall Dimensions – Basic configuration

#### Installation with stainless steel brackets

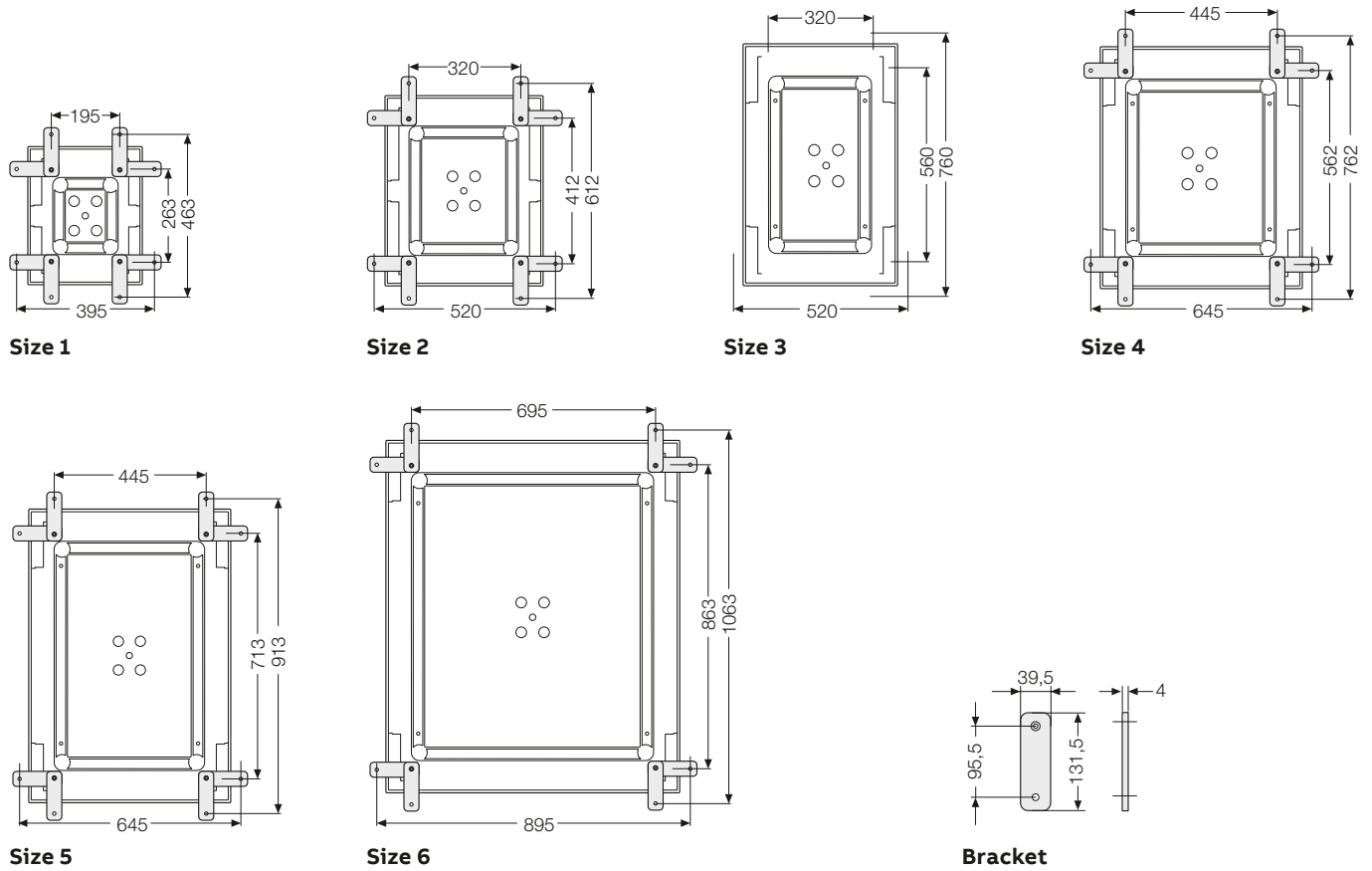

#### External opaque and transparent doors

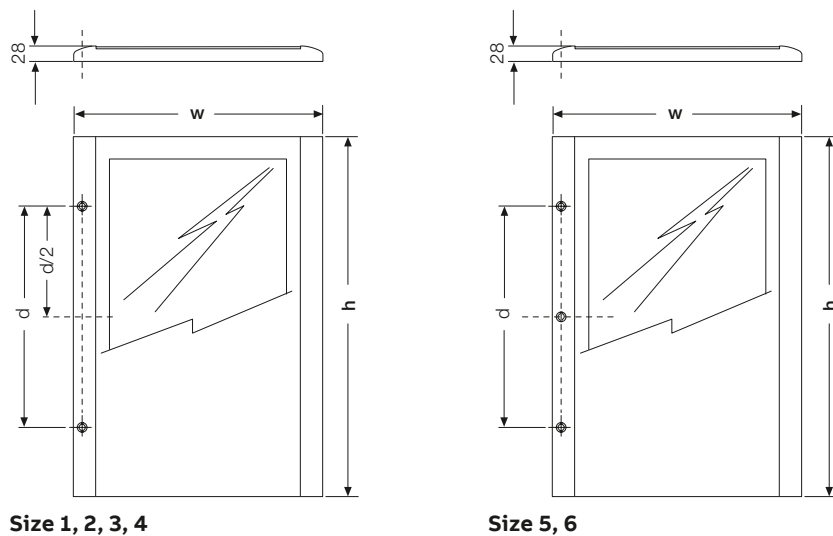

Size	w	h	Locks	d = lock distance
1	325	349	2	200
2	450	499	2	300
3	450	649	2	400
4	575	649	2	400
5	575	799	3	500
6	825	949	3	750



## General purpose enclosures technical details

### Gemini - Overall Dimensions – Components for automation applications

#### Base plate

##### Metal, drilled

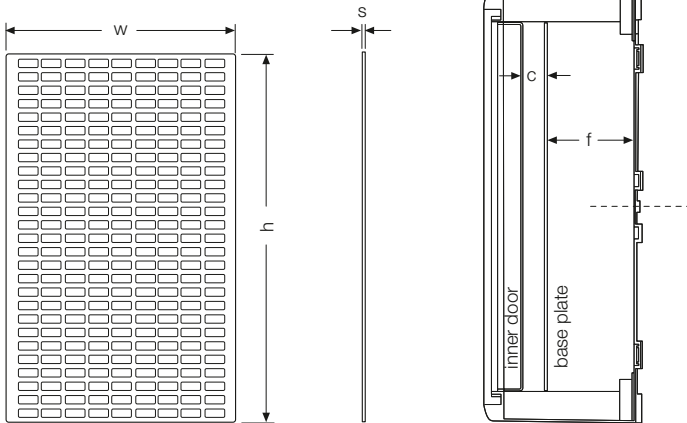

##### Metal, blank and insulating

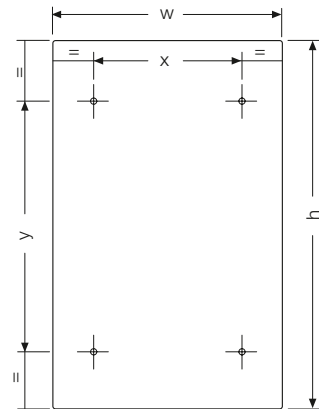

Size	w	h	Metal, blank and drilled		Insulating		f = base distance		c = distance inner door		Distance of the plate from the inner door
			s	s	MIN.	MAX.	MIN.	MAX.			
1	235	285	2	5	16,3	91	33,5	110	-		
2	360	435	2	5	36,4	140	33,5	139	152,4		
3	360	585	2	5	36,4	140	33,5	139	152,4		
4	485	585	2	5	36,4	140	33,5	139	152,4		
5	485	735	2	5	47	244	33,5	228	252,0		
6	735	885	2	5	47	244	33,5	228	252,0		

#### Drilling for base mounting with code 1SL0383A00

Size	x	y
1	-	-
2	337	248
3	337	398
4	462	398
5	462	548
6	711	698

The distance of the plate from the base and inner door depends on the installation point selected for mounting the plate on the box.

#### Inner doors

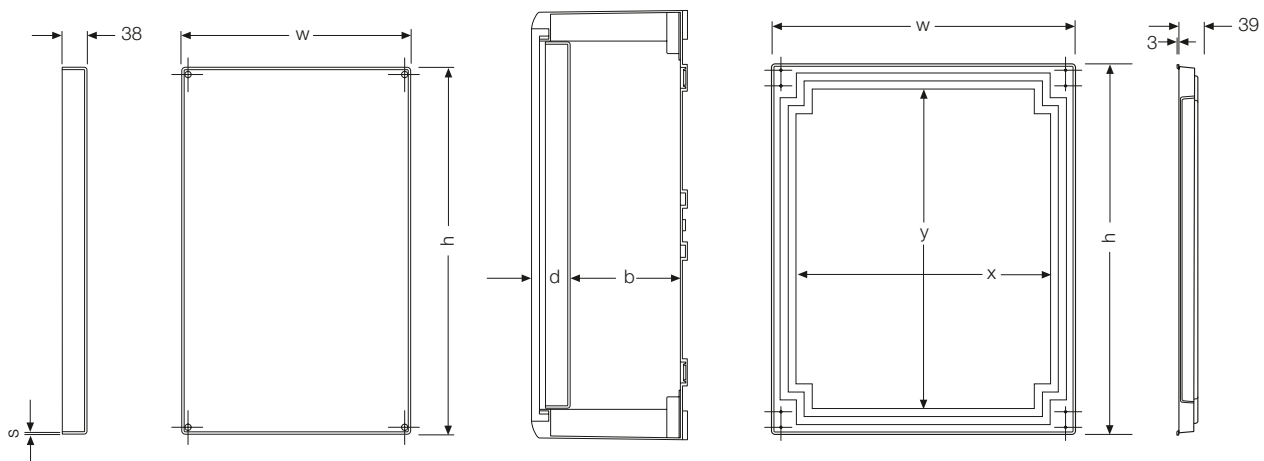

Size	w	h	s	Inner door distance		x	y
				d = door	b = base		
1	250	300	3	63	128	245	295
2	375	450	4	63	177	365	435
3	375	600	4	63	177	215	435
4	500	600	4	63	177	340	440
5	500	750	4	63	277	340	590
6	750	900	4	63	277	585	735

Measurements are expressed in millimeters.

## General purpose enclosures technical details

Gemini - Overall Dimensions – Components for distribution and mixed applications

### Uprights

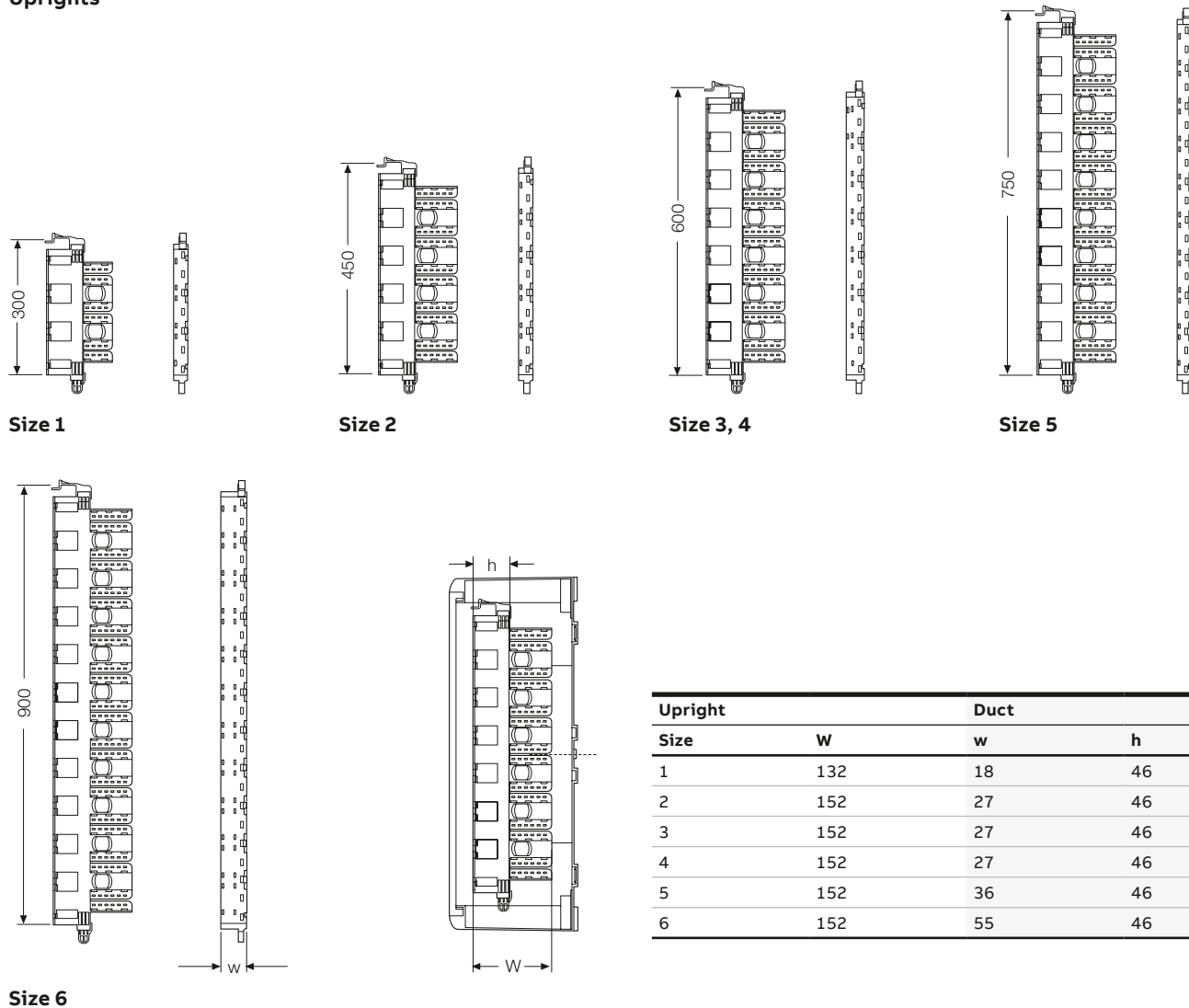

Upright	Duct		
Size	W	w	h
1	132	18	46
2	152	27	46
3	152	27	46
4	152	27	46
5	152	36	46
6	152	55	46

## General purpose enclosures technical details

Gemini - Overall Dimensions – Components for distribution and mixed applications

### DIN rails

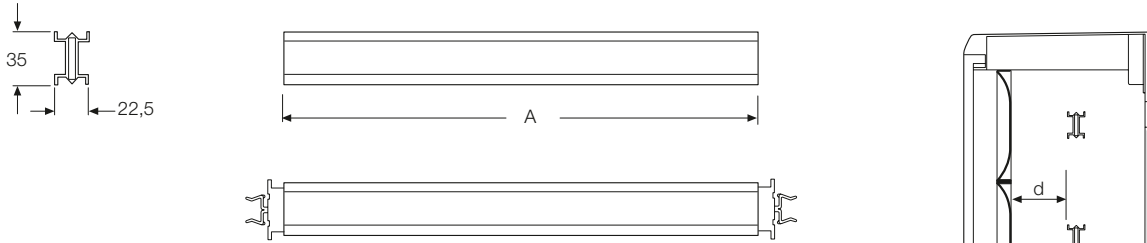

Size	A	d = distance between panel with holes/DIN rail					
		pos. 1	pos. 2	pos. 3	pos. 4	pos. 5	pos. 6
1	210	51	63,5	76	88,5	-	-
2	318	51	63,5	76	88,5	101	113,5
3	318	51	63,5	76	88,5	101	113,5
4	443	51	63,5	76	88,5	101	113,5
5	443	51	63,5	76	88,5	101	113,5
6	663	51	63,5	76	88,5	101	113,5

The distances of the DIN rail from the Panel depend on depth adjustment made through rail mountings.

### Drilled panels

#### 1 + 1/2 module

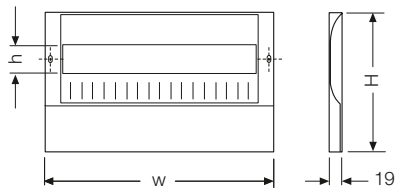

#### 1 module

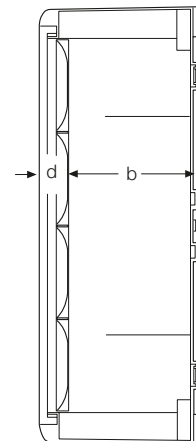
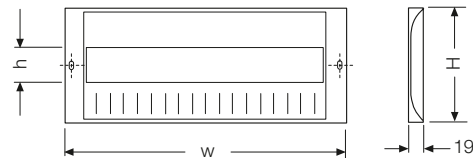

Drilled panel	1 mod.		1+1/2 mod.		Window	Panel distance	Panel distance	
	w	H	w	H			h	module
1	250	150	-	-	46	12	44	145
2	375	150	375	225	46	18	44	197
3	375	150	375	225	46	18	44	197
4	500	150	500	225	46	24	44	197
5	500	150	500	225	46	24	44	297
6	750	150	750	225	46	36	44	297

Measurements are expressed in millimeters.

## General purpose enclosures technical details

Gemini - Overall Dimensions – Components for distribution and mixed applications

### Blank panels

#### Blank panel 2 modules

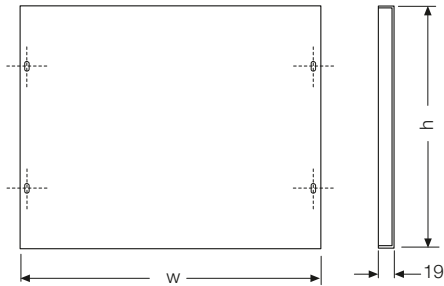

#### Blank panel 1 module

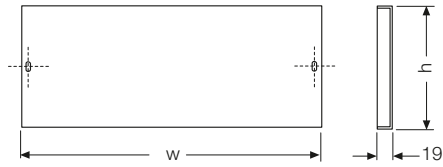

#### Blank panel 1/2 module

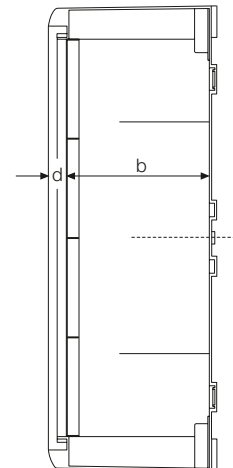
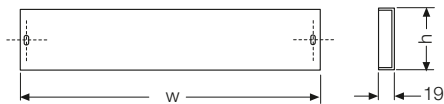

Size	1/2 mod.		1 mod.		2 mod.		Panel distance	
	w	h	w	h	w	h	d = door	b = base
1	250	75	250	150	250	300	26,5	162
2	375	75	375	150	375	300	26,5	214
3	375	75	375	150	375	300	26,5	214
4	500	75	500	150	500	300	26,5	214
5	500	75	500	150	500	300	26,5	314
6	750	75	750	150	750	300	26,5	314

## General purpose enclosures technical details

Gemini - Overall Dimensions – Components for distribution and mixed applications

### Kit for Tmax

#### Kit H 150

Plate

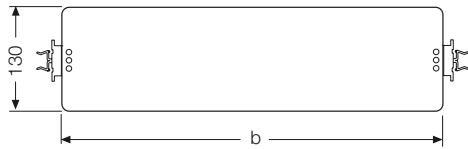

Panel

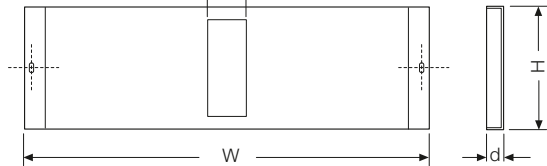

#### Kit H 300

Plate

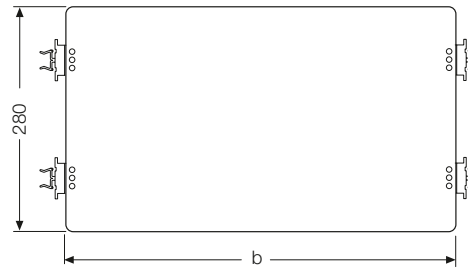

Panel

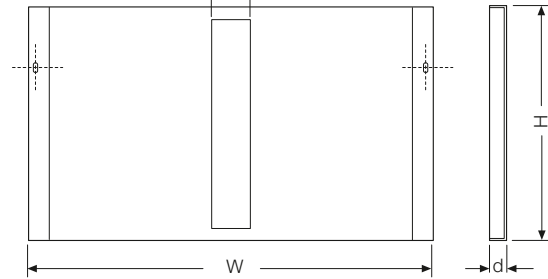

kit for Tmax H 150 (available for sizes 2-6)

Size	W	H	d	f	b
2	375	150	19	46	318
3	375	150	19	46	318
4	500	150	19	46	443
5	500	150	19	46	443
6	750	150	19	46	663

kit for Tmax H 300 (available for sizes 2-6)

Size	W	H	d	f	b
2	375	300	19	46	318
3	375	300	19	46	318
4	500	300	19	46	443
5	500	300	19	46	443
6	750	300	19	46	663

## General purpose enclosures technical details

Gemini - Overall Dimensions – Components for distribution and mixed applications

### Kit for Tmax XT

#### Kit H 150

Plate

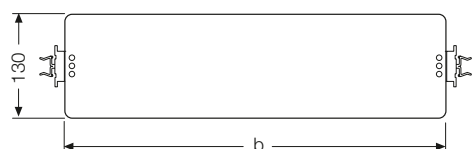

Panel

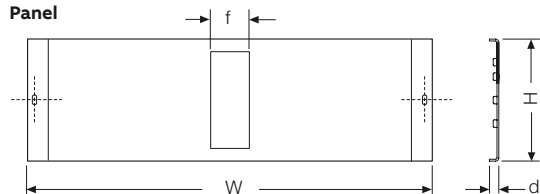

kit for Tmax XT H 150 (available for sizes 2-6)

Size	W	H	d	f	b
2	375	150	10	46	318
3	375	150	10	46	318
4	500	150	10	46	443
5	500	150	10	46	443
6	750	150	10	46	663

#### Kit H 300

Plate

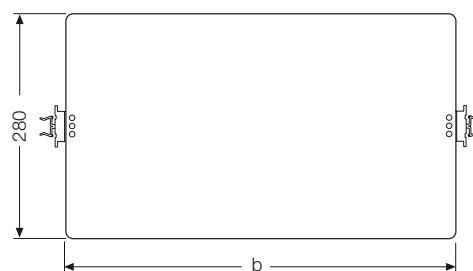

Panel

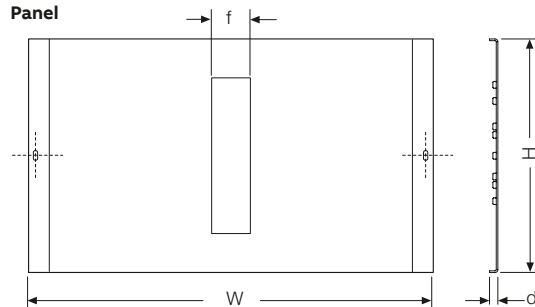

kit for Tmax XT H 300 (available for sizes 2-6)

Size	W	H	d	f	b
2	375	300	10	46	318
3	375	300	10	46	318
4	500	300	10	46	443
5	500	300	10	46	443
6	750	300	10	46	663

## General purpose enclosures technical details

Gemini - Overall Dimensions – Components for distribution and mixed applications

### Modular plates

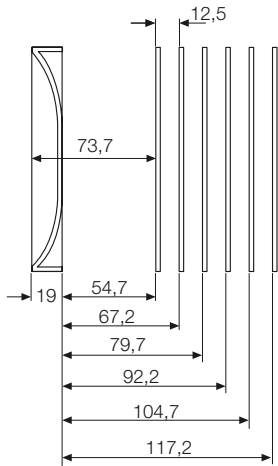
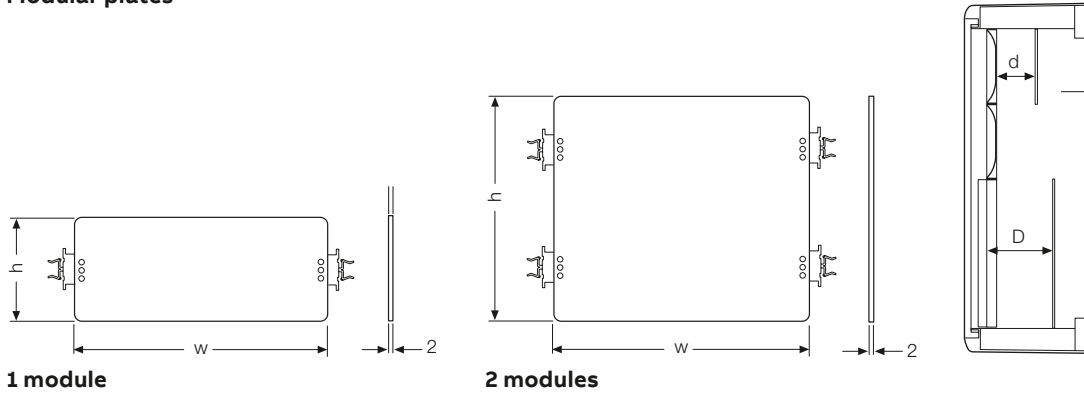

Drilled panel

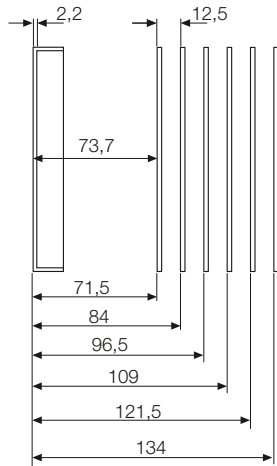

Blank panel

Size	1 module		2 modules	
	w	h	w	h
1	210	130	-	-
2	318	130	318	280
3	318	130	318	280
4	443	130	443	280
5	443	130	443	280
6	663	130	663	280

D = distance blank panel/plate						
pos. 1	pos. 2	pos. 3	pos. 4	pos. 5	pos. 6	
71,5	84	96,5	109	-	-	
71,5	84	96,5	109	121,5	134	
71,5	84	96,5	109	121,5	134	
71,5	84	96,5	109	121,5	134	
71,5	84	96,5	109	121,5	134	
71,5	84	96,5	109	121,5	134	

d = distance drilled panel/plate						
pos. 1	pos. 2	pos. 3	pos. 4	pos. 5	pos. 6	
54,7	67,2	79,7	92,2	-	-	
54,7	67,2	79,7	92,2	104,7	117,2	
54,7	67,2	79,7	92,2	104,7	117,2	
54,7	67,2	79,7	92,2	104,7	117,2	
54,7	67,2	79,7	92,2	104,7	117,2	
54,7	67,2	79,7	92,2	104,7	117,2	

The distance of the panels from the modular plates depends on the depth at which the DIN rail is regulated by using fixing devices.

## General purpose enclosures technical details

Gemini - Overall Dimensions – Components for distribution and mixed applications

### Coupling kit

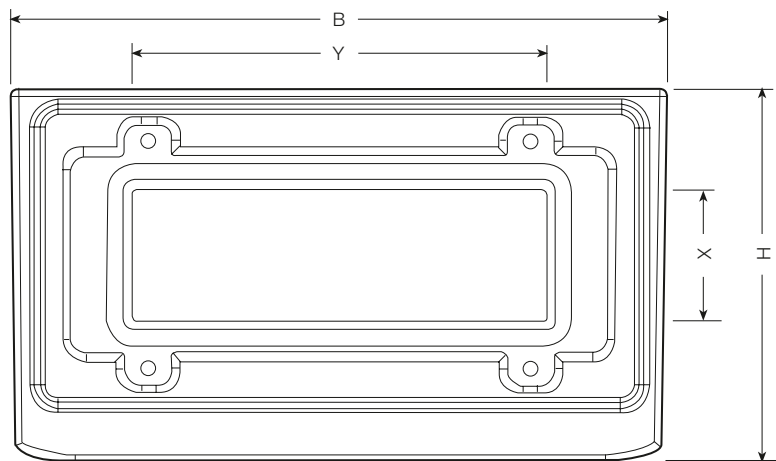

Size	B	H	X	Y
1	-	-	-	-
2	455	258	90	286
3	455	258	90	286
4	583	260	90	412
5	583	360	190	412
6	834	360	190	662

### Bottom base H 30

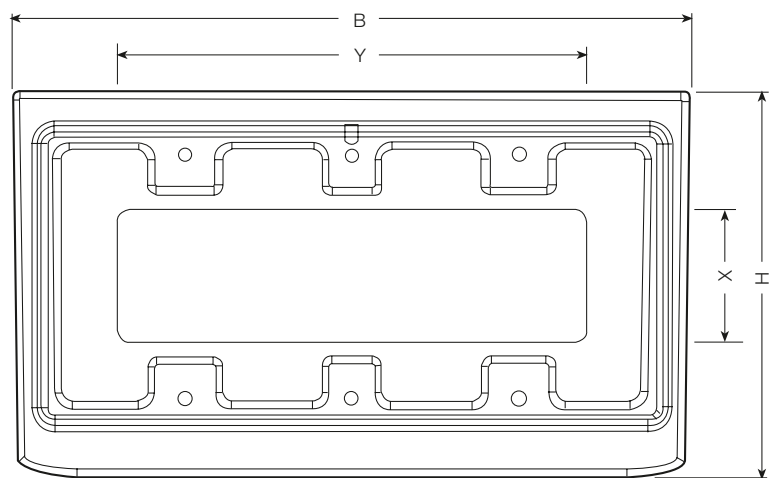

Size	B	H	X	Y
1	-	-	-	-
2	458	260	91	316
3	458	260	91	316
4	583	260	91	440
5	590	366	164	400
6	840	366	164	640



## General purpose enclosures technical details

Gemini - Overall Dimensions – Components for distribution and mixed applications

### Fixed frame

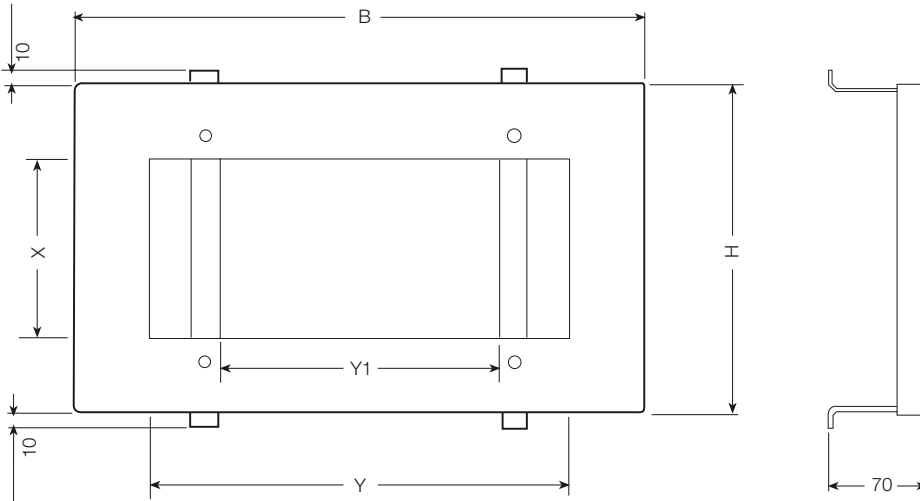

Size	B	H	X	Y	Y1
1	-	-	-	-	-
2	415	240	130	305	205
3	415	240	130	305	205
4	540	240	130	430	330
5	584	330	210	480	280
6	834	330	210	730	530

### Integral cover

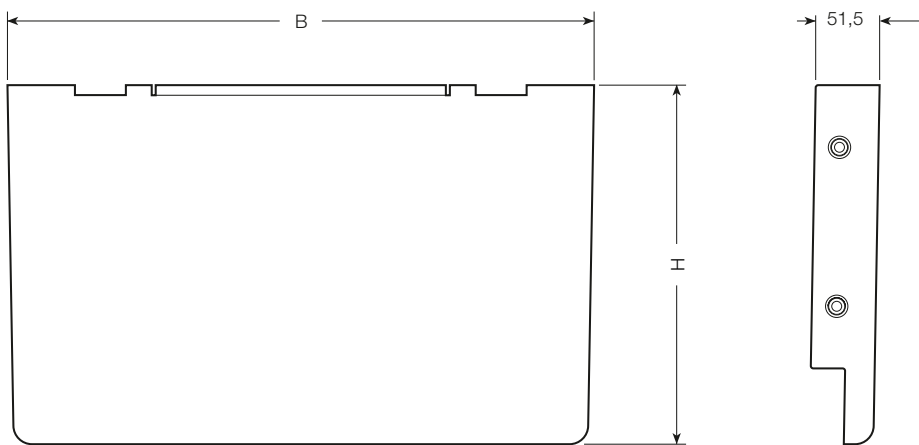

Size	B	H
1	347	238
2	472	289
3	472	289
4	600	289
5	604	390
6	854	390

## General purpose enclosures technical details

Gemini - Overall Dimensions – Components for distribution and mixed applications

### Pedestal

#### Front view

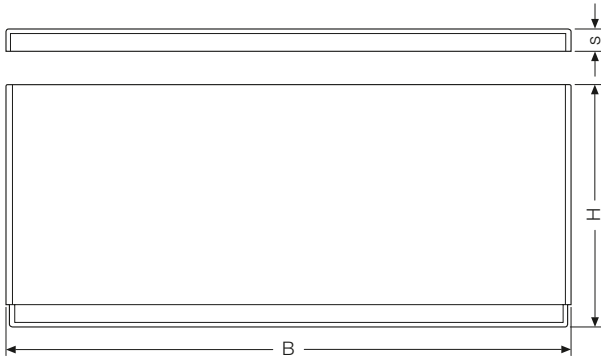

#### Size 4, 5

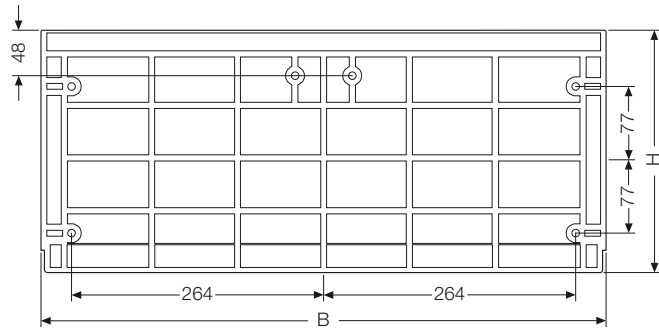

#### Size 6

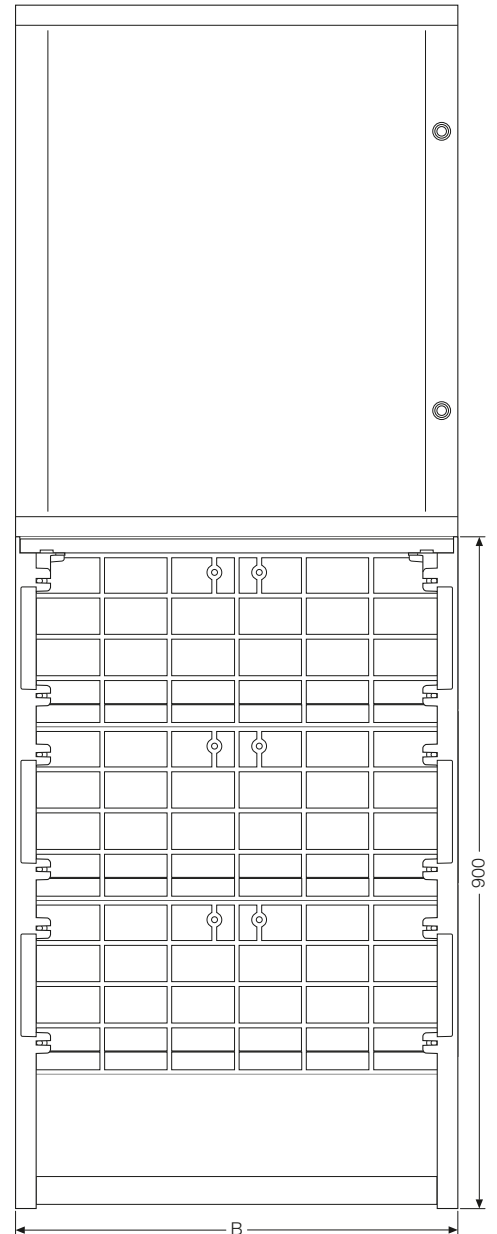
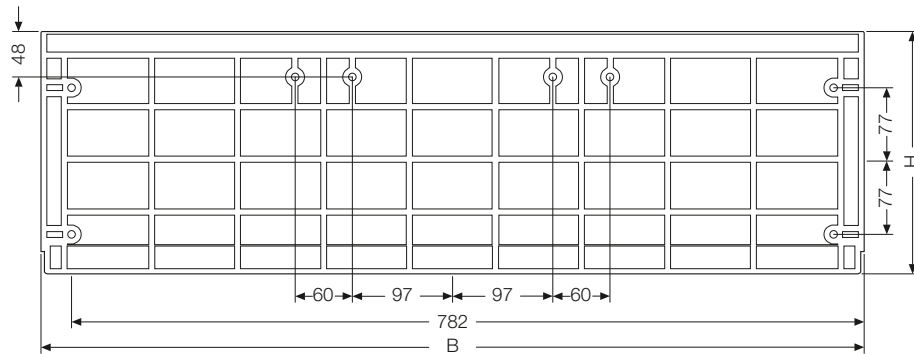

Size	B	H	s
4	592	254	28
5	592	254	28
6	846	254	28

**General purpose enclosures technical details**

Gemini - Overall Dimensions – Components for distribution and mixed applications

**Side view**

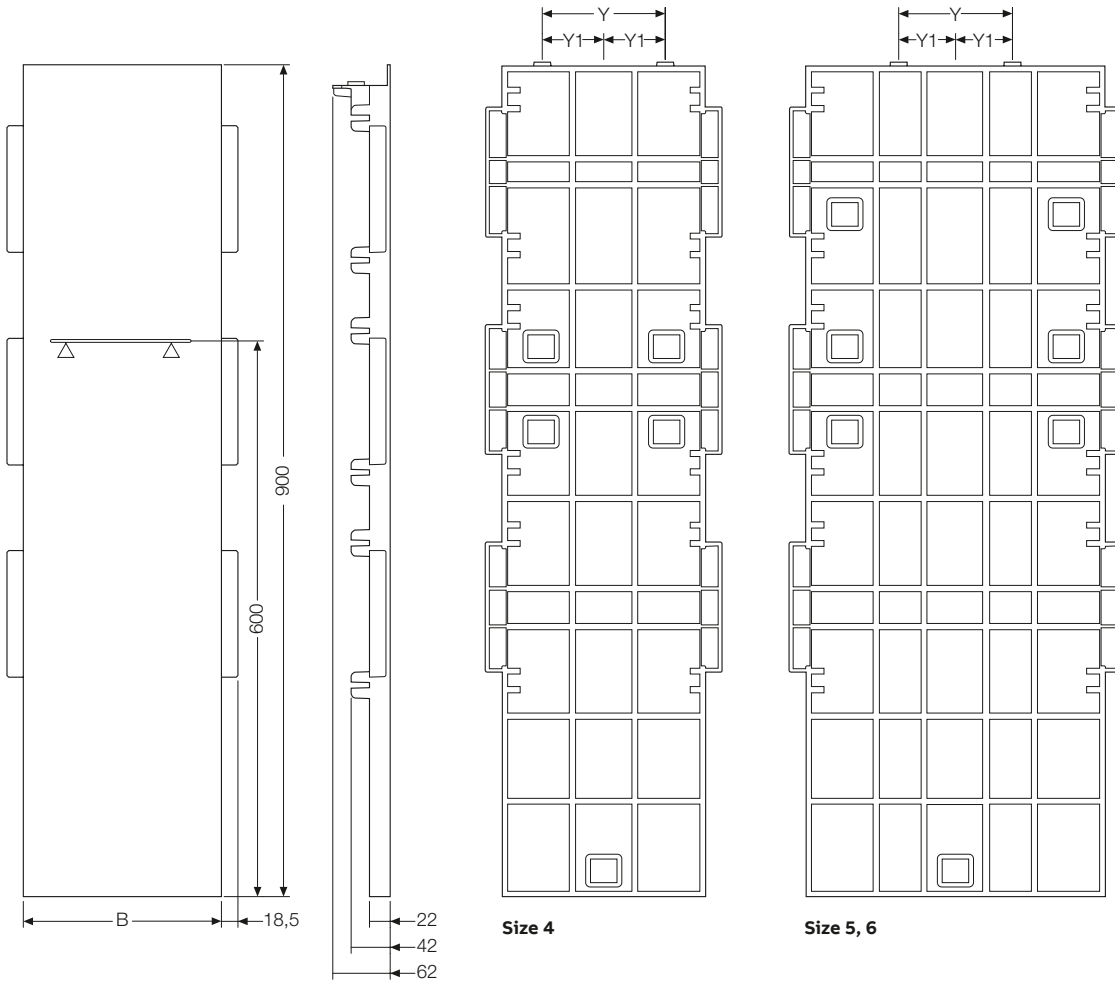

Size	B	Y	Y1
4	213	130	65
5	313	120	60
6	313	120	60

## General purpose enclosures technical details

Gemini - Overall Dimensions – Components for distribution and mixed applications

### Horizontal Gemini kit

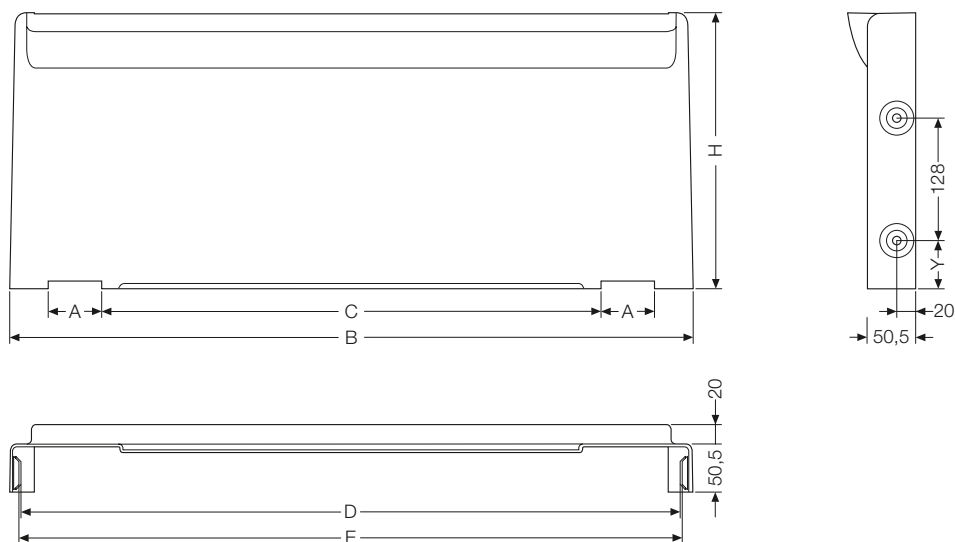

Size	A	B	C	H	Y	D	E
3	56	715,6	523	288	51	692	696
4	56	715,6	523	288	51	692	696
5	60	870	660	388	151	844	848
6	60	1021	810	388	153	994	998

### Wiring kit

Duct 25x60 mm

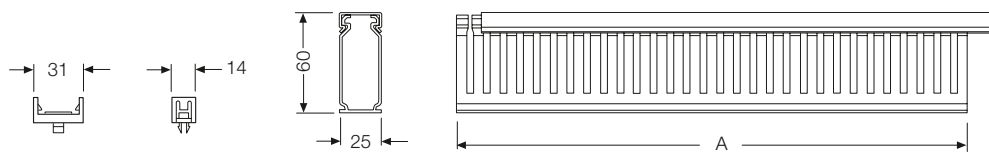

Duct 40x60 mm

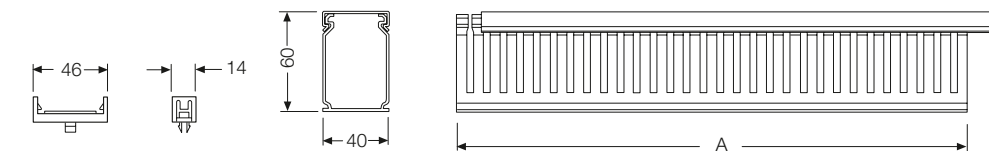

Size	A
1	210
2	318
3	318
4	443
5	443
6	663

## General purpose enclosures technical details

Gemini - Overall Dimensions – Components for distribution and mixed applications

### Ventilation kit

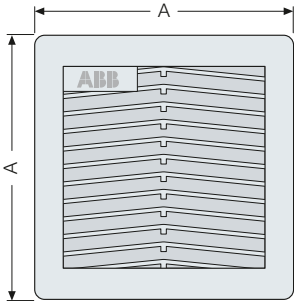

Code	A
EN0105K	105
EN0150K	150
EN0204K	204

### Anti-condensation kit

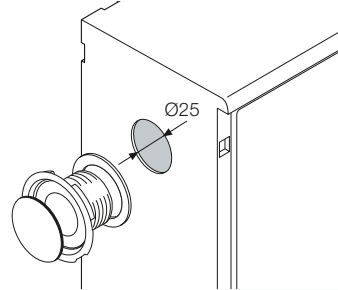

### Floor pedestals

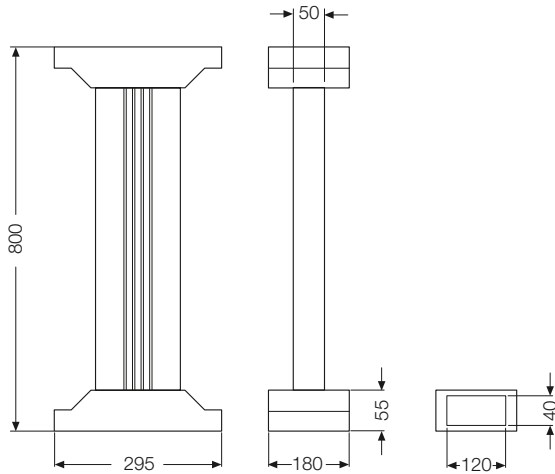

### Pole installation kit

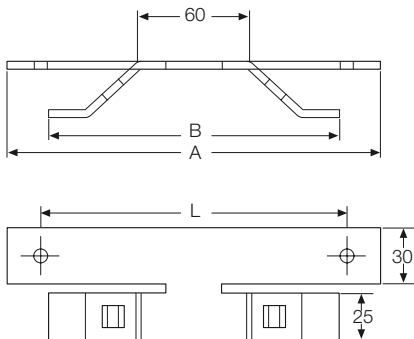

Size	A	B	L
1	232	206	196
2	358	332	320
3	358	332	320
4	483	457	447
5	483	457	447
6	733	707	697

Note: minimum pole section = 150 mm

—  
09

SR2

—  
**SR2**  
Index

<b>SR2</b>	
General characteristics of SR2 Enclosures	232
Selection table	235
Ordering codes	236
Standardised RAL colours (on request)	251
Ordering codes	252
Overall dimensions - Drillings	253
Overall dimensions - Casse	254

---

## General purpose enclosures

### General characteristics of SR2 Enclosures

**The range of SR2 enclosures is a complete offer of monobloc enclosures for constructing small and medium-sized electric automation, switching and control switchboards.**

The SR2 enclosures come from the experience ABB has gained over the years in building IP65 metal structures (in accordance with the IEC 60529 Standard), together with the innovative new production process used for construction and patented by ABB.

The typical use of SR2 Enclosures is to make switchgear and controlgear switchboards for a very wide variety of industrial machines: from large machinery with automated production lines or parts of these, down to the typical installations of on-board machine switchboards, boilers, heating plants and so on.

They conform to the EN 62208 Standard "Empty enclosures for low voltage protection switchgear and controlgear assemblies" and allow realization of electrical equipment conforming to the prescriptions of the IEC 60204-1 Standard "Safety of machinery. Electrical equipment of machines" and of the EN 60439-1 Standard and the new EN 61439-1-2 Standard "Low voltage protection switchgear and controlgear for assemblies". The degree of protection, in accordance with the IEC 60529 Standard "Degrees of protection of enclosures (IP Code)", is IP65.

The SR2 enclosures have also passed the control required to obtain the UL (Underwriters Laboratories) and CSA (Canadian Standards Association) Type 12 marks.

The SR2 enclosures also allow secondary distribution switchboards to be made, thanks to the possibility, in the 400, 600 and 800 mm widths, of installing the whole range of apparatus and modular circuit-breakers on DIN rails combined with special pre-drilled and hinged modular front panels, thereby allowing construction of AS/ANS type electrical switchgear conforming to the IEC 60439-1 Standard and the new EN

61439-1-2 Standard. A single line of metalwork structures therefore allows construction of automation and secondary and end distribution electrical switchboards thanks to the availability of a series of accessories (modular panels, DIN rails) and to the possibility of stacking the enclosures.





## General purpose enclosures

### General characteristics of SR2 Enclosures

The SR2 enclosures are available in two versions (blind door or glazed door) and in 23 different dimensions, as well as a further 19 combinations obtained by stacking the enclosures, up to a maximum height of 2000 mm, which guarantee ample selection possibilities for the various end applications.

The SR2 enclosures have been designed to fulfil all the typical needs of the builder or installer of switchgear in the best way possible and the user is presented with a unique ensemble of functional characteristics:

- wide dimensional range
- certified IP65 degree of protection
- internal galvanised sheet mounting plate with 20/10 thickness (made to allow threaded holes to be made easily), adjustable in depth by using a special accessory
- fairlead plate screwed on (at top and bottom) made of 15/10 thick galvanised sheet, with a sealing gasket applied inside
- complete reversibility of the enclosure, so the door can open either on the right or on the lefthand side
- possibility of installing all the apparatus and modular circuit-breakers on a DIN rail combined with a hinged modular panel

The standard colour is RAL 7035 orange peel. On request, the SR2 enclosures can be ordered in a wide range of RAL colours (see page 251).

Both the enclosures with glazed door or blind door can be stacked: stacking is done simply by removing the fairlead plates and inserting the IP65 sealing gasket (GZ....), made of neoprene with closed cells.

Assembly of the stacked enclosures is carried out by means of the same holes used for the fairlead plates.

The door is supplied with the enclosure (single code) so as to reduce the number of articles and assembly times.



## General purpose enclosures

### General characteristics of SR2 Enclosures

The range is completed with a series of accessories: brackets for wall assembly, rain shield top cover, locks of various types, internal document pocket, spacers, and spray paint for touching up. It is possible floor fixing by means plinth.



Plastic document pocket, RAL 7035, size A4, the pocket is apply within the solid doors wider than 400 mm, with stickers provided.





Many closure systems can replace the standard closures of the external doors. The inserts are interchangeable and easily replaced by loosening a nut.



The brackets for wall mounting allows installation of the boxes on the wall using the holes located on the back of the enclosure.



The bars, made of electrolytic copper with M6 threaded holes in 25 mm, can be mounted on mounting plates using the appropriate supports.

Technical characteristics	
Conformity with Standard	IEC 62208, IEC 61439-1-2
Degree of protection	IP65 (IEC 60529) UL Listed: UL 508A NEMA: Types 1, 3R, 12
Degree of mechanical strength	IK10 blind door IK09 glazed door (IEC 62262)
Certifications	 
Type of material	Metallic
Installation site	Indoor/outdoor
Fixing method	floor/wall
Normal service conditions - ambient temperature	from -5 up to +40°C
Operating climate (t°/Ur%)	constant 23°C/83% - 40°C/93%
	variable 23°C/98% - 40°C/98%

## General purpose enclosures

### SR2 - Selection table

#### Quick selection table

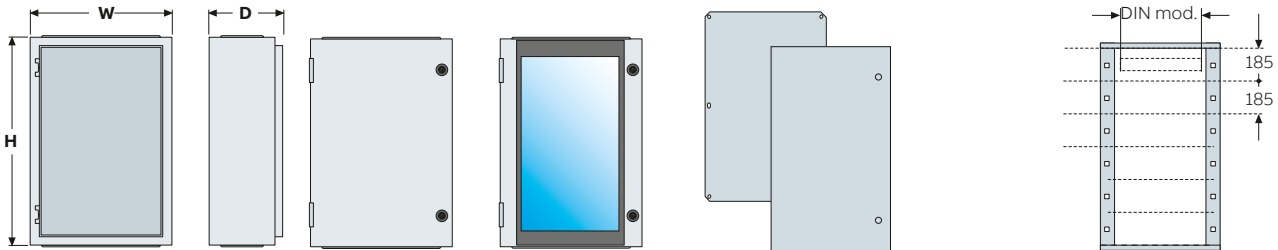

Overall dimensions			Enclosures		Kit for automation		Kit for distribution Supports for mounting modular panels				
H mm	W mm	D mm	Enclosures with blind door + back plate	with glazed door *	Blind counterdoor	Back plate	No. vertical mod. H=185mm	No. DIN mod. per row	Total modules	DIN Supports	
300	200	150	SRN3215K								
	300		SRN3315K								
	400		SRN3415K								
400	300	150	SRN4315K								
	300		200	SRN4320K							
	400		SRN4420K								
	600		SRN4620K								
500	300	200	SRN5320K								
	400		SRN5420K	SRN5420VK*	KC5040K	PF5040	2	14	28	KD5040K	
	400		250	SRN5425K	SRN5425VK*	KC5040K	PF5040	2	14	28	KD5040K
600	400	200	SRN6420K	SRN6420VK*	KC6040K	PF6040	3	14	42	KD6040K	
	400		250	SRN6425K	SRN6425VK*	KC6040K	PF6040	3	14	42	KD6040K
	600		SRN6625K								
700	500	200	SRN7520K	SRN7520VK*	KC7050K	PF7050					
	500		250	SRN7525K	SRN7525VK*	KC7050K	PF7050				
800	600	250	SRN8625K	SRN8625VK*	KC8060K	PF8060	4	25	100	KD8060K	
	600		300	SRN8630K	SRN8630VK*	KC8060K	PF8060	4	25	100	KD8060K
	800		SRN8830K								
1000	600	250	SRN10625K	SRN10625VK*	KC1060K	PF1060	5	25	125	KD1060K	
	600		300	SRN10630K	SRN10630VK*	KC1060K	PF1060	5	25	125	KD1060K
	800		SRN10830K	SRN10830VK*	KC1080K	PF1080	5	36	180	KD1080K	
1200	600	300	SRN12630K	SRN12630VK*	KC1260K	PF1260	6	25	150	KD1260K	
	800		SRN12830K	SRN12830VK*	KC1280K	PF1280	6	36	216	KD1280K	

\* The mounting plate must be ordered separately.

## General purpose enclosures

### SR2 - Ordering codes

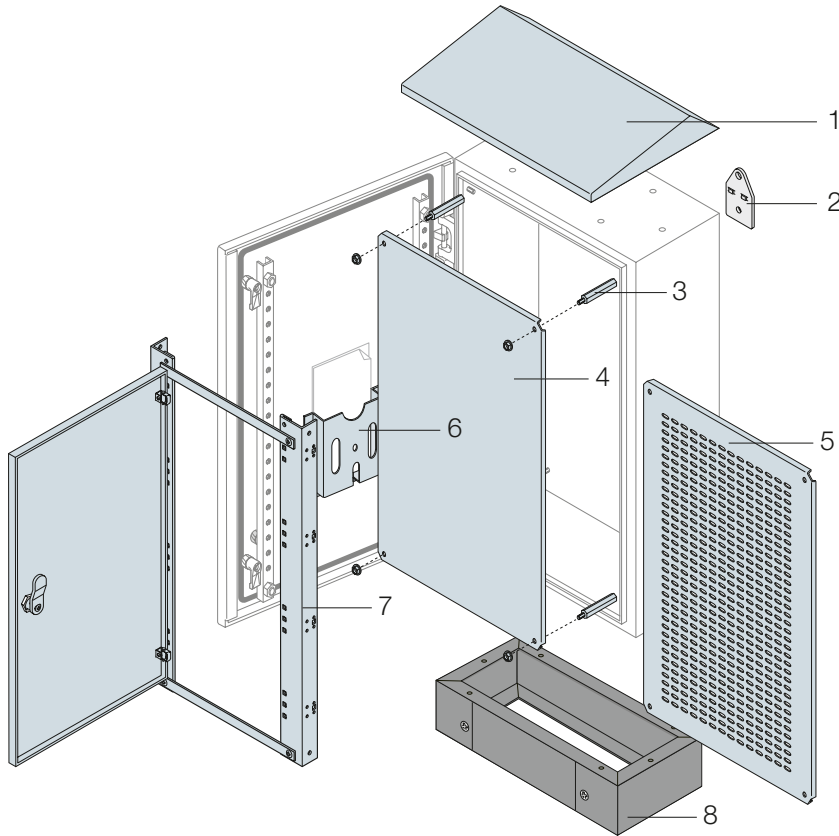

1 - Spray protection roof

2 - Wall-mounting brackets

3 - Spacers for back plates

4 - Blind internal plate

5 - Slotted internal plate

6 - Document pocket

7 - Counterdoor

8 - Plinth

9 - Frame for DIN rail

10 - Modular panels for apparatus

11 - DIN rail

12 - Blind modular panels

13 - Modular panel for DIN rail

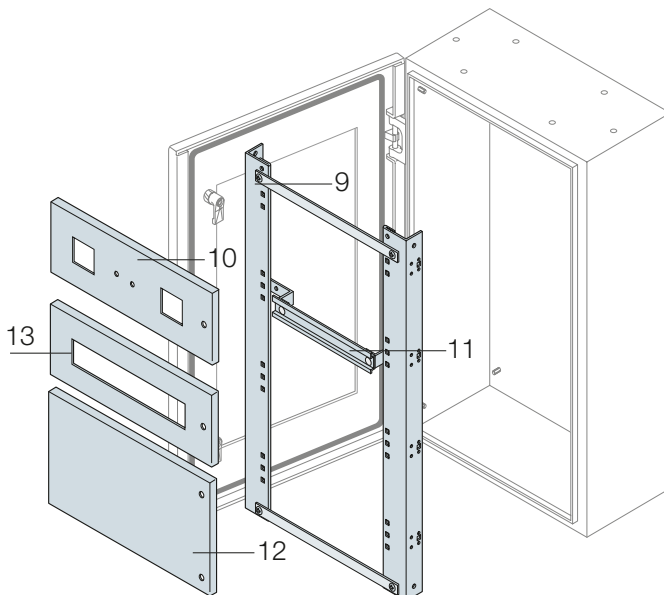

## General purpose enclosures

### SR2 - Ordering codes

#### SR2 Enclosures with blind door (internal plate included)

The enclosures with blind door, typically for making automation switchgear, are already fitted with the internal galvanised sheet mounting plate.

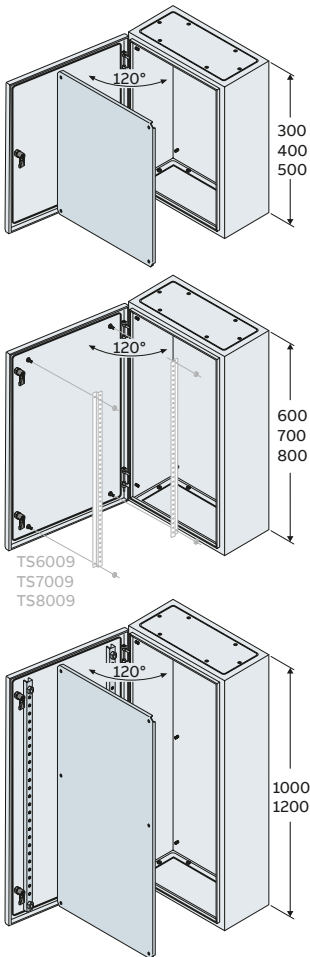

Enclosures with blind door (internal plate included)				
Dimensions (mm)			Code	Package/ No. of pieces
H	W	D		
300 <sup>(1)</sup>	200	150	SRN3215K	1/1
	300	150	SRN3315K	1/1
	400	150	SRN3415K	1/1
400 <sup>(1)</sup>	300	150	SRN4315K	1/1
	300	200	SRN4320K	1/1
	400	200	SRN4420K	1/1
500 <sup>(1)</sup>	600	200	SRN4620K	1/1
	300	200	SRN5320K	1/1
	400	200	SRN5420K	1/1
600	400	250	SRN5425K	1/1
	400	200	SRN6420K	1/1
	400	250	SRN6425K	1/1
700	600	250	SRN6625K	1/1
	500	200	SRN7520K	1/1
	500	250	SRN7525K	1/1
800	600	250	SRN8625K	1/1
	600	300	SRN8630K	1/1
	800	300	SRN8830K	1/1
1000*	600	250	SRN10625K	1/1
	600	300	SRN10630K	1/1
	800	300	SRN10830K	1/1
1200*	600	300	SRN12630K	1/1
	800	300	SRN12830K	1/1

<sup>(1)</sup> The enclosures with height less or equal to 500mm have only a closing box.

\* Plates height 1000 / 1200mm have six mounting points .

## General purpose enclosures

### SR2 - Ordering codes

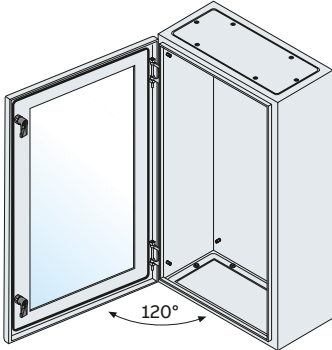

#### Enclosures with glazed door

The enclosures with glazed door are also used for distribution configurations. The internal equipment is made, alternatively, by selecting the special kits:

- KD... (Distribution Kit) consisting of a pair of functional uprights for assembly of the modular panels (to be ordered separately) and of any compensation panel.

The modular panels, which can also be installed on the enclosures with blind door with the help of the KD.. kit itself, are all hinged and have vertical modularity of 185 mm.

Enclosures with glazed door				
Dimensions (mm)				
H	W	D	Code	Package/ No. of pieces
500 <sup>(1)</sup>	400	200	SRN5420VK	1/1
	400	250	SRN5425VK	1/1
600	400	200	SRN6420VK	1/1
	400	250	SRN6425VK	1/1
700	500	200	SRN7520VK	1/1
	500	250	SRN7525VK	1/1
800	600	250	SRN8625VK	1/1
	600	300	SRN8630VK	1/1
1000	600	250	SRN10625VK	1/1
	600	300	SRN10630VK	1/1
	800	300	SRN10830VK	1/1
1200	600	300	SRN12630VK	1/1
	800	300	SRN12830VK	1/1

<sup>(1)</sup> The enclosures with height less or equal to 500mm hare only a closing box.

## General purpose enclosures

### SR2 - Ordering codes

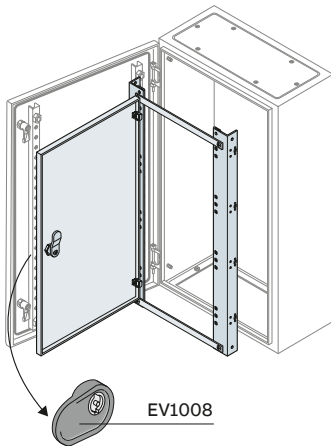

#### Blind counterdoor

The internal counterdoor guarantees IP20 degree of protection. Made of steel sheet 15/10mm thick, galvanized and painted orange peel RAL 7035 colour, complete with the EV1008 ergonomic box and insert with double tongue.

Blind counterdoor			
Dimensions (mm)			Package/ No. of pieces
H	W	Code	
500	400	KC5040K	1/1
600	400	KC6040K	1/1
700	500	KC7050K	1/1
800	600	KC8060K	1/1
1000	600	KC1060K	1/1
1000	800	KC1080K	1/1
1200	600	KC1260K	1/1
1200	800	KC1280K	1/1

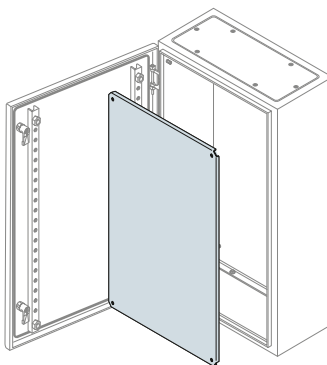

#### Blind internal mounting plate

Internal galvanised sheet mounting plate 20/10mm thick complete with fixing with small items provided. Possibility of adjusting the depth with the help of a special spacer kit (to be ordered separately).

Blind back plate for enclosure			
Dimensions (mm)			Package/ No. of pieces
H	W	Code	
300	200	PF3020	1/1
300	300	PF3030	1/1
300	400	PF3040	1/1
400	300	PF4030	1/1
400	400	PF4040	1/1
400	600	PF4060	1/1
500	300	PF5030	1/1
500	400	PF5040	1/1
600	400	PF6040	1/1
600	600	PF6060	1/1
700	500	PF7050	1/1
800	600	PF8060	1/1
800	800	PF8080	1/1
1000	600	PF1060	1/1
1000	800	PF1080	1/1
1200	600	PF1260	1/1
1200	800	PF1280	1/1

## General purpose enclosures

### SR2 - Ordering codes

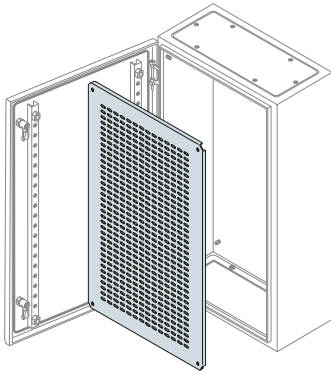

#### Slotted internal mounting plate

Fixing with small items provided. Possibility of adjusting the depth with the help of a special spacer kit (to be ordered separately).

#### Back plate for enclosure

Dimensions (mm)			Package/ No. of pieces
W	H	Code	
200	300	TQ3020	1/1
300	300	TQ3030	1/1
400	300	TQ3040	1/1
300	400	TQ4030	1/1
400	400	TQ4040	1/1
600	400	TQ4060	1/1
300	500	TQ5030	1/1
400	500	TQ5040	1/1
400	600	TQ6040	1/1
600	600	TQ6060	1/1
500	700	TQ7050	1/1
600	800	TQ8060	1/1
800	800	TQ8080	1/1
600	1000	TQ1060	1/1
800	1000	TQ1080	1/1
600	1200	TQ1260	1/1
800	1200	TQ1280	1/1

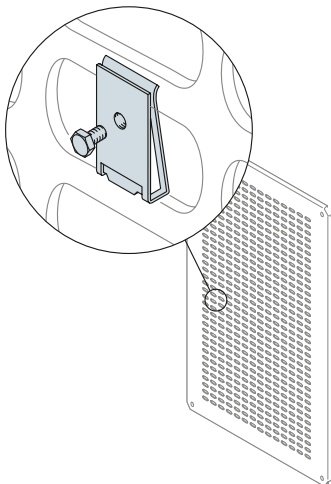

#### Clip nuts

For slotted plates with M6x10mm hexagonal head screws.

Description	Code	Package/ No. of pieces
No.20 clip nuts	TQ6610	1/20

#### Spacer Kit for adjusting the depth of the back plates

Kit consisting of 12 spacers for fixing the back plate with the possibility of adjusting the depth with 25 mm pitch.

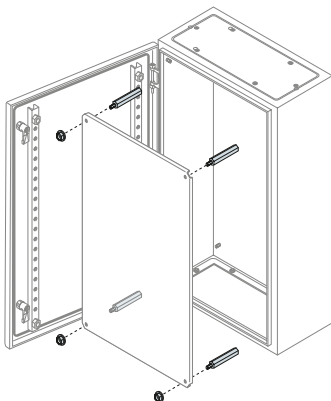

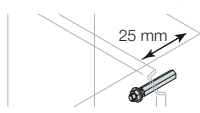
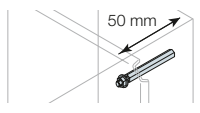
Description	Code	Package/ No. of pieces
Spacers 25mm long	AA8025	1/12
		
Spacers 50mm long	AA8050	1/12
		



## General purpose enclosures

### SR2 - Ordering codes

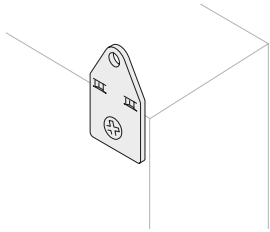

#### Brackets for wall fixing

These allow wall installation of the enclosures and are mounted by using the special holes positioned on the rear of the enclosures.

Description	Code	Package/ No. of pieces
Brackets for wall fixing	AA1206	1/4

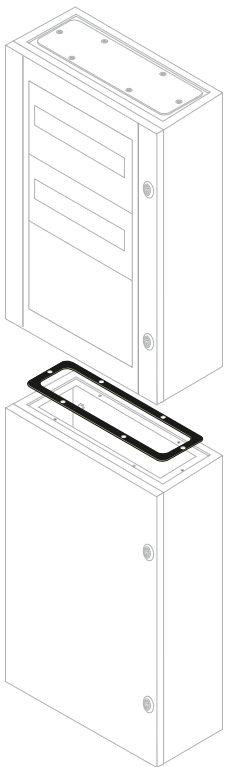

#### Accessories for stacking

Dimensions (mm)			Package/ No. of pieces
W	D	Code	
<b>IP65 gasket</b>			
400	200	GZ4020	1/1
	250	GZ4025	1/1
600	200	GZ6020	1/1
	250	GZ6025	1/1
	300	GZ6030	1/1
800	300	GZ8030	1/1

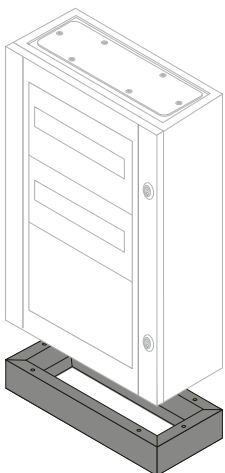

#### Plinth

Steel plinth 25/10 thick grey RAL7012 color.

Plinth				Package/ No. of pieces
Dimensions (mm)			Code	
W	D	H	Code	
400	200	100	ZA4020	1/1
	250	100	ZA4025	1/1
600	250	100	ZA6025	1/1
	300	100	ZA6030	1/1
800	300	100	ZA8030	1/1

## General purpose enclosures

### SR2 - Ordering codes

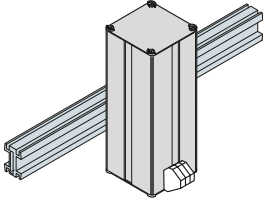

#### Temperature management

##### IP20 heater

Their use prevents condensation in the electric cabinets. They consist of a heating element (PTC thermistor) inserted in an aluminium alloy ground plate. The PTC thermistor is a component which modifies its impedance according to the operating temperature. It is intrinsically stable and ensures primary safety features for the heater and service stability.

The main qualities of the heaters using PTC are:

- electrical absorption (or dissipated power) which is almost constant in
- the range of power supply voltage between 100 and 250V;
- electrical absorption bound by inverse law to the trend of the ambient temperature.

The special tubular geometry of the ground plate allows efficient thermal exchange with the heating element. This allows high powers and limited overall dimensions (especially in width and depth); Snap-on assembly on 35 mm DIN rail. Requires a thermostat.

Description	Dimensions (mm)			Code	Package/ No. of pieces
	H	W	D		
Anti-condensation heater 30W, 110-240 Vac-dc	115	42	42	VA7930	1/1
Anti-condensation heater 50W, 110-240 Vac-dcc	165	42	42	VA7950	1/1
Anti-condensation heater 75W, 110-240 Vac-dc	210	42	42	VA7975	1/1
Anti-condensation heater 100W, 110-240 Vac-dc	165	42	51	VA7910	1/1
Anti-condensation heater 150W, 110-240 Vac-dc	146	82	51	VA7915	1/1
Anti-condensation heater with fan 300W, 230 Vac-dc	148	82	91	VA8300	1/1

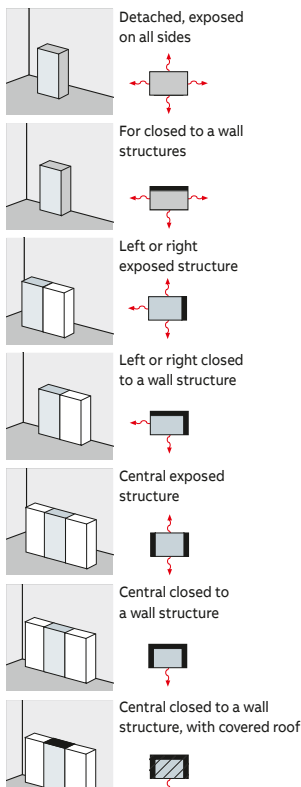

All the heaters with PTC absorb a higher power than the rated one on inrush according to a transitory which lasts a few tenths of a second.

If the heaters are to be supplied by means of an auxiliary transformer, its apparent power must be sized taking 1.5 times the rated power of the heaters with natural aeration and twice those with forced ventilation into consideration.

#### IEC 890 method for calculating the effective cooling surface (CEI 17-43 method)

The total power dissipation P of an enclosure is linked to the exchange effective dissipating surface S, the ΔT difference between the inner and outer temperature and the k coefficient of heat exchange relative to the material of the enclosure:

$$P = k * \Delta T * S$$

$$k = 5,5 \text{ for painted steel}$$

$$\Delta T = T1 - T2;$$

T1 = dew point temperature (on average 25 °C)

T2 = minimum ambient temperature.

## General purpose enclosures

### SR2 - Ordering codes

The exchange surface  $S$  can be calculated using the following table taken from the CEI 17-43

Disposition of the cabinet	Calculating the enclosure surface $S$ (mm <sup>2</sup> )	Dimensions (m)
Detached, exposed on all sides	$S = 1,8 \times H \times (L+P) + 1,4 \times L \times P$	L = width H = height P = depth
For closed to a wall structures	$S = 1,4 \times L \times (H+P) + 1,8 \times P \times H$	
Left or right exposed structure	$S = 1,4 \times P \times (H+L) + 1,8 \times L \times H$	
Left or right closed to a wall structure	$S = 1,4 \times H \times (P+L) + 1,4 \times L \times P$	
Central exposed structure	$S = 1,8 \times L \times H + 1,4 \times L \times P + P \times H$	
Central closed to a wall structure	$S = 1,4 \times L \times (H+P) + P \times H$	
Central closed to a wall structure, with covered roof	$S = 1,4 \times L \times H + 0,7 \times L \times P + P \times H$	

Using a SRN8630K box, in “for closed to a wall structures” case we will obtain:

$$T_1 = 25 \text{ °C}; T_2 = 20 \text{ °C}; K = 5,5; \Delta T = (25-20) = 5 \text{ °C}; S = 1,4\text{m}^2$$

The total power dissipation  $P$  obtained will be:

$$P = k * \Delta T * S = 38,5 \text{ W}$$

The recommended heater is VA7950 (50W).

### Temperature management

#### IP20 Thermostat

Conforms to EN 60730-1, CE and cURus standards, IP20 degree of protection. Grey RAL 7035 colour; electrical life 100,000 cycles. Dimensions (HxWxD) 68x29x45mm, can be mounted on DIN rail. The version with NO (normally open) contact allows closure of a circuit activating ventilation, air conditioning, or alarms. The version with NC (normally closed) contact allows opening of a circuit, disconnecting any anti-condensation resistances.

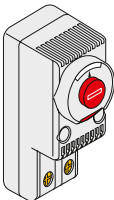

Description	Standard power supply V~/50-60Hz	Code	Package/ No. of pieces
NO ventilation thermostat	12-60 V d.c.; 110-250V a.c.	EN0101K	1/1
NC heating thermostat	12-60 V d.c.; 110-250V a.c.	EN0102K	1/1

Code	Standard power supply V~/50-60Hz	Contact capacity		Temperature scale	Type of contact	Weight
		Load $\Omega$	Load L			
EN0101K	12-60 V d.c.; 110-250V a.c.	10A	2A	-10 +80 °C	NO	54g
EN0102K	12-60 V d.c.; 110-250V a.c.	10A	2A	-10 +80 °C	NC	54g

### Frame for DIN rail

Internal supports for fixing modular panels and DIN rails, colour RAL 7035 orange peel.

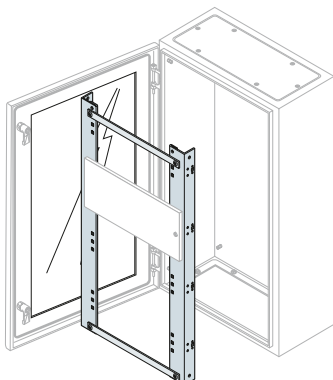

Description	Dimensions (mm)			Code	Package/ No. of pieces
	H	W			
Supports 14 mod. DIN x 2 rows	500	400		KD5040K	1/1
Supports 14 mod. DIN x 3 rows	600	400		KD6040K	1/1
Supports 25 mod. DIN x 4 rows	800	600		KD8060K	1/1
Supports 25 mod. DIN x 5 rows	1000	600		KD1060K	1/1
Supports 36 mod. DIN x 5 rows	1000	800		KD1080K	1/1
Supports 25 mod. DIN x 6 rows	1200	600		KD1260K	1/1
Supports 36 mod. DIN x 6 rows	1200	800		KD1280K	1/1

## General purpose enclosures

### SR2 - Ordering codes

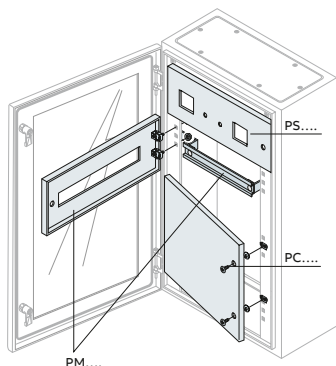

#### Modular panels

Modular panels made of 12/10mm thick sheet steel painted RAL 7035 colour orange peel. The modular hinged panels can be mounted on the enclosures by using the special kit (KD...) consisting of functional uprights and compensation panel. The hinges patented by ABB, allow automatic earthing for panel contact when it is closed and are also suitable conventional earthing (with a cable). Each modular panel (PM) has a DIN rail provided (adjustable in depth), the fixing brackets and the relative small items. Modular and circuit-breakers and Tmax moulded-case circuit-breakers up to T3 can be placed side by side on the same DIN rail using the special depth adapter AP6001. To install moulded-case circuit-breakers, it is necessary to fix the DIN rail in a position towards the back. The fixing brackets of the DIN rail allow the wiring duct to be mounted up to a maximum size of 60 x 60 mm.

#### Modular hinged panels for modular apparatus (DIN rail and fixing brackets included)

Description	Dimensions (mm)			Package/ No. of pieces
	H	W	Code	
14 mod. DIN + fixing bracket	185	400	PM1414K	1/1
25 mod. DIN + fixing bracket	185	600	PM1625K	1/1
36 mod. DIN + fixing bracket	185	800	PM1836K	1/1

#### Modular hinged panels for measuring instruments

Description	Dimensions (mm)			Package/ No. of pieces
	H	W	Code	
2 instruments 72 x 72mm	185	400	PS2476K	1/1
2 instruments 72 x 72mm	185	600	PS2676K	1/1
2 instruments 72 x 72mm	185	800	PS2876K	1/1

#### Modular hinged blind panels

Description	Dimensions (mm)			Package/ No. of pieces
	H	W	Code	
Blind panel	185	400	PC1406K	1/1
Blind panel	185	600	PC1606K	1/1
Blind panel	185	800	PC1806K	1/1
Blind panel	370	600	PC2606K	1/1
Blind panel	370	800	PC2806K	1/1

#### DIN rail and fixing brackets

Description	No. of modules	W (mm)	Code	Package/ No. of pieces
DIN rail and fixing brackets	14	400	GD4006	1/1
DIN rail and fixing brackets	25	600	GD6006	1/1
DIN rail and fixing brackets	36	800	GD8006	1/1

#### Depth adapter

No.1 depth adapter for Tmax T1-T2-T3-XT1-XT3 W=600mm	AP6001	1/4
---	--------	-----

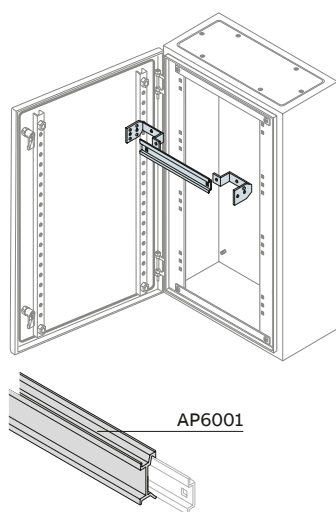

#### Polished flange for DIN-Rail mounting

Description	Code	Package/ No. of pieces
Polished flange for XT1 3P mounted on DIN rail	AD3301	1/1
Polished flange for XT1 4P mounted on DIN rail	AD3302	1/1
Polished flange for XT3 3P mounted on DIN rail	AD3303	1/1
Polished flange for XT3 4P mounted on DIN rail	AD3304	1/1

Already supplied in the DIN-Rail mounting kit for breakers in MCCBs catalogue

## General purpose enclosures

### SR2 - Ordering codes

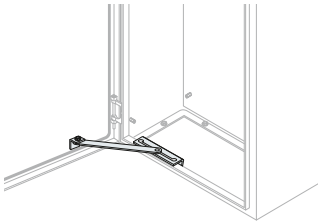

#### Door anti-closure device

It can't be mounted with the inner-door or with modular/blind panels mounted down in structure and hinged.

Description	Code	Package/ No. of pieces
Door anti-closure device	EV0015	1/4

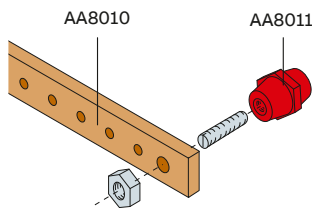

#### Neutral or earthing busbars

The busbars, made of electrolytic copper with M6 threaded holes with 25 mm pitch, can be mounted on the back plates by means of the special supports. They must be sized according to the enclosure and the position they are installed in.

Description	W (mm)	Code	Package/ No. of pieces
No. 4 busbars sect. 20x5mm	1000	AA8010	1/4
No.5 support for busbar		AA8011	1/5

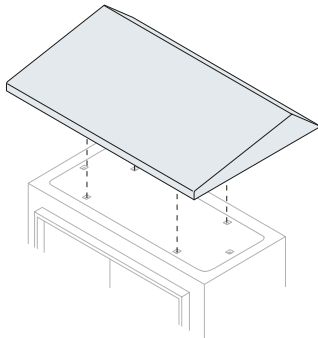

#### Spray protection roofs

To improve protection against entry of liquids and rain. Made of 15/10mm thick sheet steel, painted RAL 7035 colour orange peel.

Spray protection roof			Package/ No. of pieces
Dimensions (mm)			
W	D	Code	
200	150	TT2015K	1/1
300	150	TT3015K	1/1
400	150	TT4015K	1/1
300	200	TT3020K	1/1
400	200	TT4020K	1/1
500	200	TT5020K	1/1
600	200	TT6020K	1/1
400	250	TT4025K	1/1
500	250	TT5025K	1/1
600	250	TT6025K	1/1
600	300	TT6030K	1/1
800	300	TT8030K	1/1

#### Shaped sections for accessories

These allow fixing of accessories (e.g. wiring ducts) inside the blind doors. They consist of a pair of vertical crosspieces made of 15/10mm thick white galvanised sheet, pre-drilled with 25 mm pitch. In the enclosures with 1000 and 1200 mm height with blind door, the shaped sections are already provided.

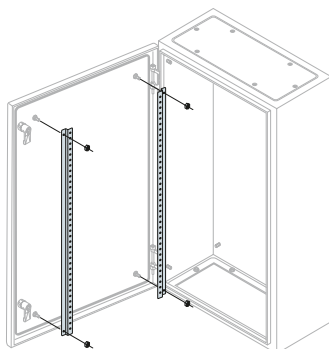

Description	Dimensions (mm)		Package/ No. of pieces
	H	Code	
No. 2 shaped sections for door	600	TS6009	1/1
No. 2 shaped sections for door	700	TS7009	1/1
No. 2 shaped sections for door	800	TS8009	1/1
No. 2 shaped sections for door	1000	1SLM400000A9000	1/1

## General purpose enclosures

### SR2 - Ordering codes

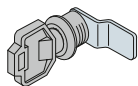

AA8001

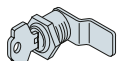

AA8002

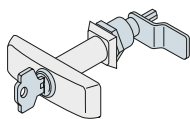

AA8003



EV1008

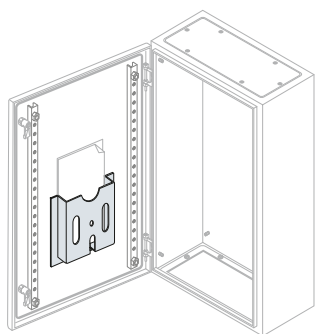

#### Closing systems

These can replace the standard closures of the external doors.

The inserts are interchangeable and easily replaced by loosening a single nut.

Description	Code	Package/ No. of pieces
Box Ø 19 mm double tongue and plastic key (spare part)	AA8001	1/1
Box Ø 19 mm with security insert and Yale type key	AA8002	1/1
Box Ø 19 mm with handle and Yale type key	AA8003	1/1
Box Ø 19 mm with triangular insert	AA5200	1/1
Plastic key for triangular insert AA5200	AA5190	1/1
Ergonomic box complete with double tongue insert (without tongue)	EV1008	1/1
Single code Yale insert	EV1036	1/1
Ronis 455 insert for	EV1037	1/1
3mm Double tongue insert	EV1039	1/1

#### Document pocket RAL 7035

Made of plastic, RAL 7035 colour, A4 size. The pocket can be glued inside the blind door with a width of more than 400 mm, using the adhesives provided.

Description	Code	Package/ No. of pieces
Plastic document pocket for A4	EV1075K	1/1

#### Special Painting Service

Special painting service has to manage with code of enclosure SRN....SPEC ( e.g. SRN4320SPEC VERNRSR + note about color required ). It is necessary specify the color required in the order. Minimum order quantity 4 pieces. For any other component or further information, please contact you local sales network.

Description	Code	Package/ No. of pieces
Extra cost for special SR painting	VERNSR	

#### Accessories for DIN panel

##### Hole covering strip RAL7035 colour

Description	Code	Package/ No. of pieces
No.10 hole covers W=2000mm, grey	AD1086	1/10
No.3 hole covers 24 DIN modules W=600mm	AD1088	1/3
No.3 hole covers 36 DIN modules W=800mm	AD1089	1/3

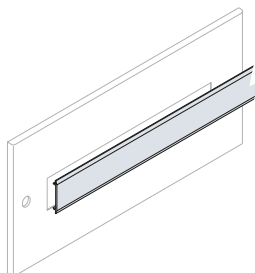

## General purpose enclosures

### SR2 - Ordering codes

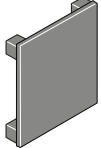
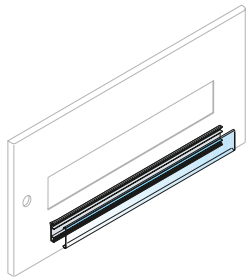
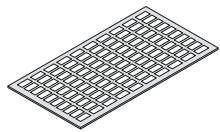
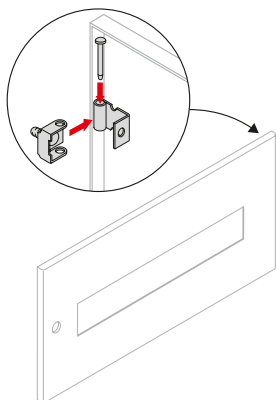

EV1137

EV1135  
EV1136AD1101-AD1102  
AD1103-AD1104EH2118-EH2129  
AD1600-AD1800

#### Closing plug for instrument holder panels

Description	Code	Package/ No. of pieces
No.10 closing plug for instrument holder panels 72x72mm	EV1135	1/10
No.5 closing plug for instrument holder panels 96x96mm	EV1136	1/5
No.50 tappi di chiusura per pulsanti Ø22 mm	EV1137	1/50

#### Adhesive name label holders

Description	Dimensions (mm)		Package/ No. of pieces
	W	Code	
No. 20 label holders 18 DIN mod	325	EH2118	1/20
No. 20 label holders 29 DIN mod	525	EH2129	1/20
No. 20 label holders 24 DIN mod	432	AD1600	1/20
No. 20 label holders 36 DIN mod	634	AD1800	1/20

#### Etichette scrivibili con sistema Grafoplast compatibile

Description	No. of DIN mod.	Code	Package/ No. of pieces
No. 288 labels 1 DIN mod.	1	AD1101	1/288
No. 192 labels 2 DIN mod.	2	AD1102	1/192
No. 96 labels 3 DIN mod.	3	AD1103	1/96
No. 96 labels 4 DIN mod.	4	AD1104	1/96

#### Hinges and quick closures for panels

Description	Code	Package/ No. of pieces
No. 10 hinges for panels	EH1889 <sup>(1)</sup>	1/10
No. 5 quick closures for front panels	EH1890	1/5

<sup>(1)</sup> Use No.2 hinges for panel H=150/200/300/400mm, No.3 hinges for panel H=500/600mm.

## General purpose enclosures

### SR2 - Ordering codes

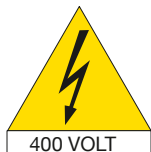
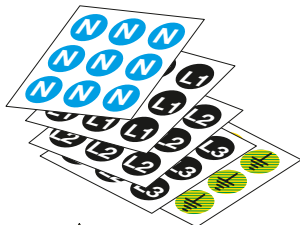

#### Marking

Description	Code	Package/ No. of pieces
No.5 adhesive labels ABB-IS2 W=1000mm	EV1157	1/5
No.490 adhesive labels Ø 12mm N symbol	EV1150	1/490
No.490 adhesive labels Ø 12mm L1symbol	EV1151	1/490
No.490 adhesive labels Ø 12mm L2 symbol	EV1152	1/490
No.490 adhesive labels Ø 12mm L3 symbol	EV1153	1/490
No.490 adhesive labels Ø 12mm T symbol	EV1154	1/490
No.10 triangular adhesive labels 125mm with 400V lightning arrow symbol	EV1155	1/10
No.100 triangular adhesive labels 50mm with lightning arrow symbol	EV1156	1/100

#### Screws for apparatus

Description	Code	Package/ No. of pieces
No.1000 perforating screws 4.2x13mm cross slotted head	EV1100	1/1000
No.1000 perforating screws 4.2x19mm cross slotted head	EV1101	1/1000
No.50 trilobed screws M6 L=10mm	AD1033	1/50

#### Wiring duct support brackets

Description	Code	Package/ No. of pieces
No. 100 wiring duct support brackets on upright structure	EV1131	1/100

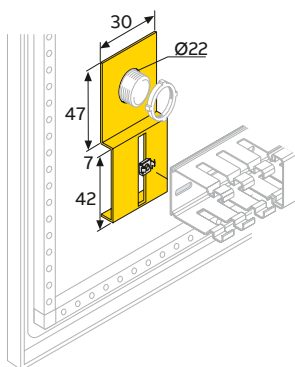



## General purpose enclosures

### SR2 - Ordering codes

#### Spare parts

Description	Code	Package/ No. of pieces
Ergonomic box complete with double tongue insert (without tongue)	EV1008	1/1
N. 10 hinges for SR2 enclosures + countersunk rivets	AA1204	1/1
N. 16 screws and nuts M6x14 for flange	AA1203	1/2
N. 2 fairlead plates for SRN3215K	FLN3215K	1/2
N. 2 fairlead plates for SRN3315K-SRN4315K	FLN3315K	1/2
N. 2 fairlead plates for SRN3415K	FLN3415K	1/2
N. 2 fairlead plates for SRN4320K-SRN5320K	FLN4320K	1/2
N. 2 fairlead plates for SRN4420K-SRN5420K-SRN6420K	FLN4420K	1/2
N. 2 fairlead plates for SRN5425K-SRN6425K	FLN4425K	1/2
N. 2 fairlead plates for SRN4620K	FLN4620K	1/2
N. 2 fairlead plates for SRN6625K-SRN8625K-SRN10625K	FLN6625K	1/2
N. 2 fairlead plates for SRN7520K	FLN7520K	1/2
N. 2 fairlead plates for SRN7525K	FLN7525K	1/2
N. 2 fairlead plates for SRN8630K-SRN10630K-SRN12630K	FLN8630K	1/2
N. 2 fairlead plates for SRN8830K-SRN10830-SRN12830K	FLN8830K	1/2
Blind door 1000x600mm (hxl)	PRN1066K	1/1
Blind door 1000x800mm (hxl)	PRN1086K	1/1
Blind door 1200x600mm (hxl)	PRN1266K	1/1
Blind door 1200x800mm (hxl)	PRN1286K	1/1
Blind door 300x200mm (hxl)	PRN3026K	1/1
Blind door 300x300mm (hxl)	PRN3006K	1/1
Blind door 300x400mm (hxl)	PRN3046K	1/1
Blind door 400x300mm (hxl)	PRN4036K	1/1
Blind door 400x400mm (hxl)	PRN4046K	1/1
Blind door 400x600mm (hxl)	PRN4066K	1/1
Blind door 500x300mm (hxl)	PRN5036K	1/1
Blind door 500x400mm (hxl)	PRN5046K	1/1
Blind door 600x400mm (hxl)	PRN6046K	1/1
Blind door 600x600mm (hxl)	PRN6066K	1/1
Blind door 700x500mm (hxl)	PRN7056K	1/1
Blind door 800x600mm (hxl)	PRN8066K	1/1
Blind door 800x800mm (hxl)	PRN8086K	1/1
Glazed door 1000x600mm (hxl)	PTN1066K	1/1
Glazed door 1000x800mm (hxl)	PTN1086K	1/1
Glazed door 1200x600mm (hxl)	PTN1266K	1/1
Glazed door 1200x800mm (hxl)	PTN1286K	1/1
Glazed door 500x400mm (hxl)	PTN5046K	1/1
Glazed door 600x400mm (hxl)	PTN6046K	1/1
Glazed door 700x500mm (hxl)	PTN7056K	1/1
Glazed door 800x600mm (hxl)	PTN8066K	1/1
Spray paint color grey RAL7035 for structure	VB7035	1/1
Spray paint color grey RAL7012 for plinth	VB7012	1/1

## General purpose enclosures

### SR2 - Ordering codes



#### Painting Special Service

Description	Code
Extra cost for special SR painting	VERNSR

#### Standard size enclosures, standard colour

Special painting service with standard colour (see on the next page) for standard size enclosures in quantities equal to or greater than 4 units with single code to be managed with code SRN ... SPEC + VERNSR overprice equal to the number of enclosures + colour note to be specified in the order.

**Example: SRN4320SPEC 4**  
**VERNSR 4**  
**COLOUR NOTE**

#### Standard size enclosures, non-standard colour

Request feasibility of implementation by completing the relevant Form for special quotations and send it to the R&D ECS office.

Management is per offer.

If the offer is accepted and after having received it, it will be possible to place the order with the codes indicated in the offer that will not be SRN...SPEC, but dummy ones.

Always remember to indicate the offer reference in the order.

#### Non-standard size enclosures, standard colour

Request feasibility of implementation by completing the relevant Form for special quotations and send it to the R&D ECS office.

Management is per offer.

If the offer is accepted and after having received it, it will be possible to place the order with the codes indicated in the offer, that will not be SRN...SPEC, but dummy ones:

Always remember to indicate the offer reference in the order.

#### Non-standard size enclosures, non-standard colour

Request feasibility of implementation by completing the relevant Form for special quotations and send it to the R&D ECS office.

Management is per offer.

If the offer is accepted and after having received it, it will be possible to place the order with the codes indicated in the offer, that will not be SRN...SPEC, but dummy ones:

Always remember to indicate the offer reference in the order.

Please note that the minimum quantity is four pieces with a single code.

## General purpose enclosures

### SR2 - Standardised RAL colours (on request)

On request, colours other than the standard RAL 7035 orange peel one are available, using the same painting cycle (for other types of colours or paints, please contact ABB).

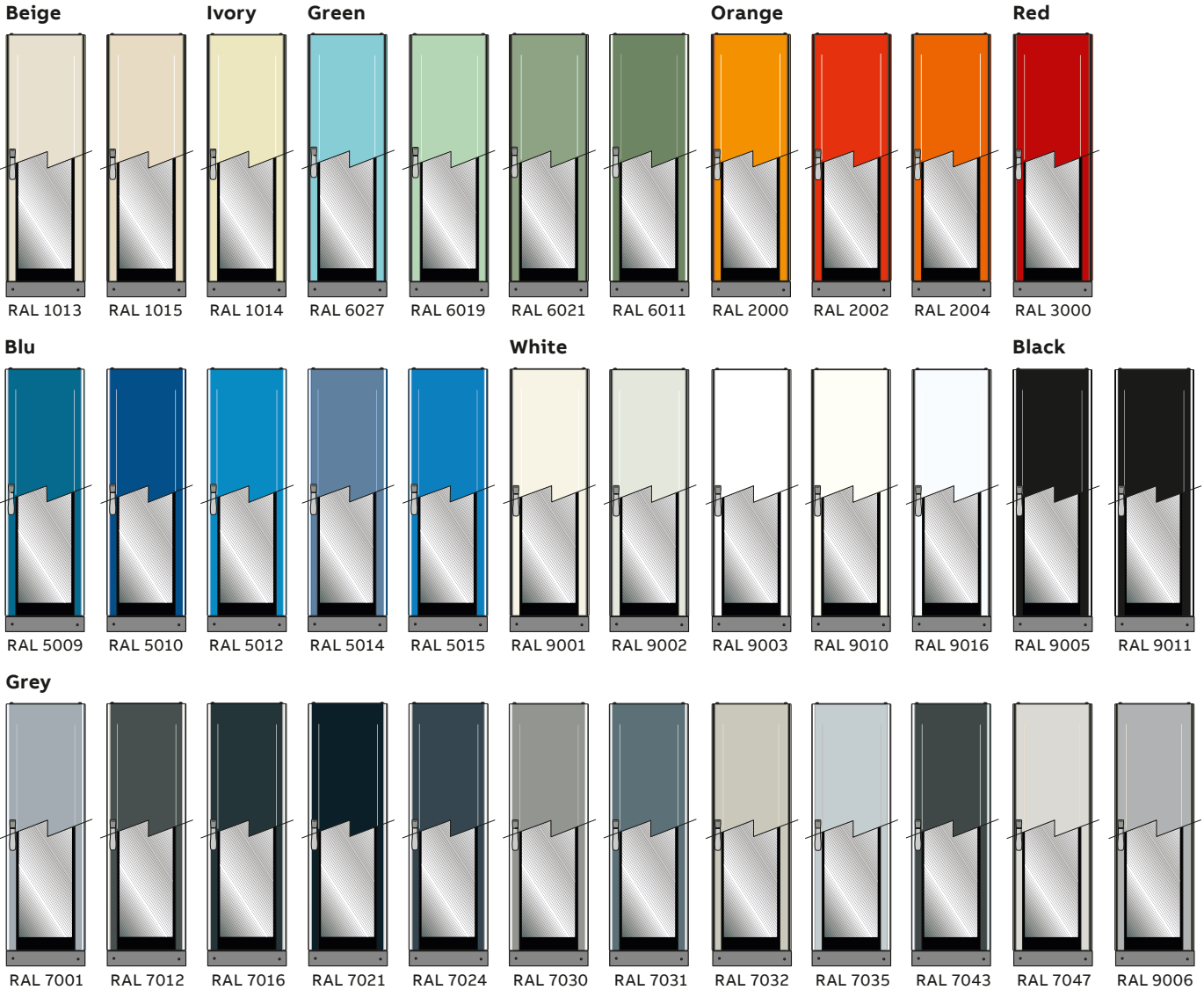

<b>RAL</b>	<b>1013</b>	<b>1015</b>	<b>1014</b>	<b>6027</b>	<b>6019</b>	<b>6021</b>	<b>6011</b>	<b>2000</b>	<b>2002</b>	<b>2004</b>	<b>3000</b>	<b>5009</b>	<b>5010</b>	<b>5012</b>	<b>5014</b>	<b>5015</b>	<b>9001</b>	<b>9002</b>
Smooth			●	●	●		●			●	●		●	●	●	●		●
Orange p.	●	●				●	●	●	●			●	●	●		●	●	●

<b>RAL</b>	<b>9003</b>	<b>9010</b>	<b>9016</b>	<b>9005</b>	<b>9011</b>	<b>7001</b>	<b>7012</b>	<b>7016</b>	<b>7021</b>	<b>7024</b>	<b>7030</b>	<b>7031</b>	<b>7032</b>	<b>7035</b>	<b>7043</b>	<b>7047</b>	<b>9006</b>
Smooth	●		●	●									●	●		●	●
Orange p.		●	●	●	●	●	●	●	●	●	●		●		●		

Other types of colours are available on request.

### Corrosion test in saline mist

(Ref. Standard UNI ISO 9227, CEI50-5/4, IEC 60068-2-30)

<b>Treatment time (hours)</b>	<b>24</b>	<b>48</b>	<b>72</b>	<b>96</b>	<b>120</b>	<b>144</b>	<b>168</b>	<b>192</b>
Rust penetration	no	no	no	no	no	no	no	193 <sup>(1)</sup>
Blistering	no	no	no	no	no	no	no	no

<sup>(1)</sup> When a tearing test with adhesive tape is carried out after 193 hours of exposure, about 3 mm of paint detachment can be noted from the notch area with 1-1.5 mm rust penetration.

## General purpose enclosures

### SR2 - Ordering codes

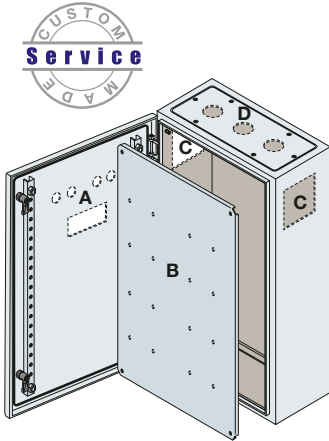

#### Special Drilling Service

The overprice amount depends on the number of individual drilled parts and not on the number of holes.

For single part it means: A-door B-plate; C-housing; D-top/bottom part.

Please note that the minimum quantity is 4 pieces with a single code.

The price of the special drilling service depends on the number of parts to be drilled and on the amount of enclosures to be drilled.

Description	Code	No. of enclosures to be drilled
Extra cost for drilling service per individual drilled part (A-B-C-D)	FORSR1	4-5-6
Extra cost for drilling service per individual drilled part (A-B-C-D)	FORSR2	7-8-9
Extra cost for drilling service per individual drilled part (A-B-C-D)	FORSR	≥ 10

#### Standard size enclosures with special drilling

The special drilling service for standard size enclosures in quantities equal to or greater than 4 units with a single code has to be managed with code SRN ... SPEC + overprice FORSR/ FORSR1/FORSSR2 (see table) equal to the number of enclosures and the number of parts to be drilled + hole layout to be attached to the order (see on the next page).

Example: Enclosure (4 pcs) with door to be drilled (1 part)

**Example: Enclosure (4 pcs) with door and plate to be drilled (1 parts)**

**SRN4320SPEC 4**

**FORSR1 4**

**DRAWINGS TO BE ATTACHED**

**Example: Enclosure (4 pcs) with door and plate to be drilled (2 parts)**

**SRN4320SPEC 4**

**FORSR1 8**

**DRAWINGS TO BE ATTACHED**

#### Non-standard enclosure sizes, special drilling

Request feasibility of implementation by completing the relevant Form for special quotations and send it together with the drill layout to the R&D ECS office.

Management is per offer.

If the offer is accepted and after having received it, it will be possible to place the order with the codes indicated in the offer, that will not be SRN...SPEC, but dummy ones.

Always remember to indicate the offer reference in the order.

**General purpose enclosures**

SR2 - Overall Dimensions - Drillings

**Drillings SR2**

Maximum useful overall dimensions for the drillings.

Flanges

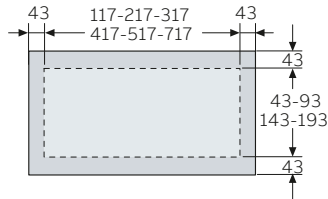

Side

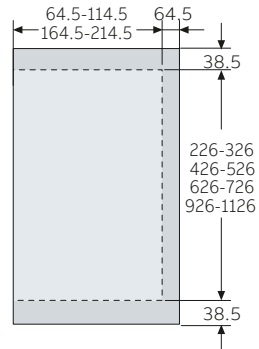

Doors H = 300-400-500

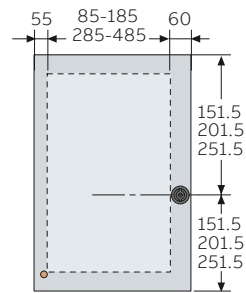

Doors H = 600-700-800

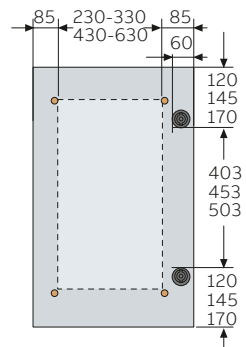

Doors H = 1000-1200

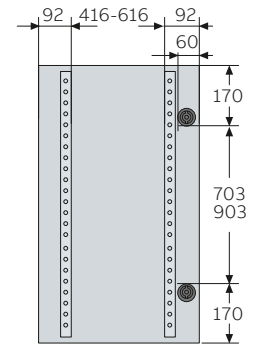

# General purpose enclosures technical details

## SR2 - Overall Dimensions – Casse

### Basic version

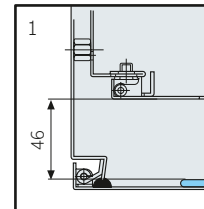
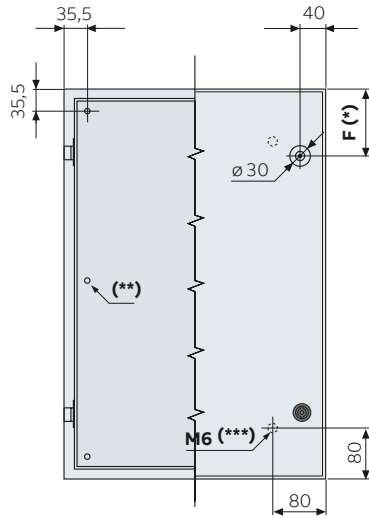
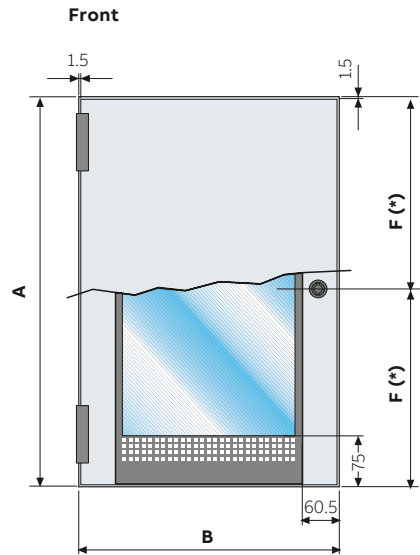

(\*) Locks (F)  
 n°1 central for enclosures from h = 303 to 503 mm  
 n°2 for enclosures from h = 603 to 703 mm (F = 100 mm)  
 n°2 for enclosures from h = 803 to 1 203 mm (F = 150 mm)

### Modular panels and inner door

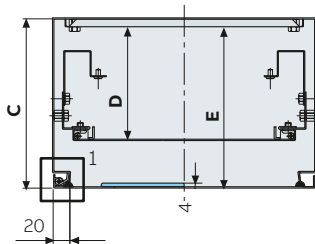

### Fairlead flange

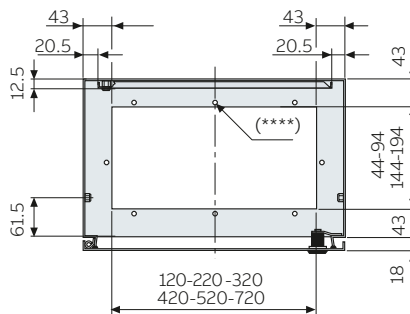

(\*\*) Copper plated nut on the rear only for enclosures from h = 1 003 to 1 203 mm

(\*\*\*) Copper plated nut on door  
 n° 1 for enclosures from h = 303 to 503 mm  
 n° 4 for enclosures from h = 603 to 803 mm  
 n° 6 for enclosures from h = 1 003 to 1 203 mm

(\*\*\*\*) Flange fixing holes  
 n° 4 for enclosures from l = 203mm  
 n° 6 for enclosures from l = 303 to 403 mm  
 n° 8 for enclosures from l = 503 to 1 203 mm

Code	A	B	C	D	E	F (*)	G	H	I	L
SRN3215K	303	203	147	82	133,5	151,5	163	337	237	263
SRN3315K	303	303	147	82	133,5	151,5	263	337	337	263
SRN3415K	303	403	147	82	133,5	151,5	363	337	437	263
SRN4315K	403	303	147	82	133,5	201,5	263	437	337	363
SRN4320K	403	303	197	132	183,5	201,5	263	437	337	363
SRN4420K	403	403	197	132	183,5	201,5	363	437	437	363
SRN4620K	403	603	197	132	183,5	201,5	563	437	637	363
SRN5320K	503	303	197	132	183,5	251,5	263	537	337	463
SRN5420K	503	403	197	132	183,5	251,5	363	537	437	463
SRN5425K	503	403	247	182	233,5	251,5	363	537	437	463
SRN6420K	603	403	197	132	183,5	100	363	637	437	563
SRN6425K	603	403	247	182	233,5	100	363	637	437	563
SRN6625K	603	603	247	182	233,5	100	563	637	637	563
SRN7520K	703	503	197	132	183,5	100	463	737	537	663
SRN7525K	703	503	247	182	233,5	100	463	737	537	663
SRN8625K	803	603	247	182	233,5	150	563	837	637	763
SRN8630K	803	603	297	232	283,5	150	563	837	637	763
SRN8830K	803	803	297	232	283,5	150	763	837	837	763

Code	A	B	C	D	E	F (*)	G	H	I	L
SRN10625K	1003	603	247	182	233,5	150	563	1037	637	963
SRN10630K	1003	603	297	232	283,5	150	563	1037	637	963
SRN10830K	1003	803	297	232	283,5	150	763	1037	837	963
SRN12630K	1203	603	297	232	283,5	150	563	1237	637	1163
SRN12830K	1203	803	297	232	283,5	150	763	1237	837	1163
SRN5420VK	503	403	197	132	183,5	150	363	537	437	463
SRN5425VK	503	403	247	182	233,5	150	363	537	437	463
SRN6420VK	603	403	197	132	183,5	150	363	637	437	563
SRN6425VK	603	403	247	182	233,5	150	363	637	437	563
SRN7520VK	703	503	197	132	183,5	150	463	737	537	663
SRN7525VK	703	503	247	182	233,5	150	463	737	537	663
SRN8625VK	803	603	247	182	233,5	150	563	837	637	763
SRN8630VK	803	603	297	232	283,5	150	563	837	637	763
SRN10625VK	1003	603	247	182	233,5	150	563	1037	637	963
SRN10630VK	1003	603	297	232	283,5	150	563	1037	637	963
SRN10830VK	1003	803	297	232	283,5	150	763	1037	837	963
SRN12630VK	1203	603	297	232	283,5	150	563	1237	637	1163
SRN12830VK	1203	803	297	232	283,5	150	763	1237	837	1163

# General purpose enclosures technical details

## SR2 - Overall Dimensions – Casse

### Centre distances for wall fixing

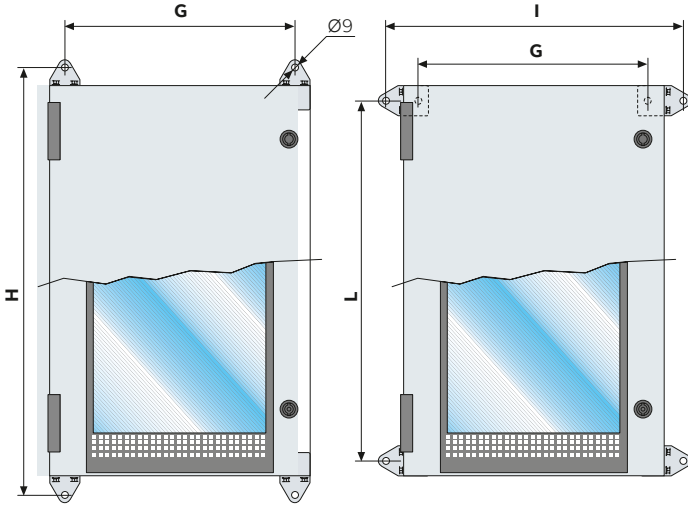

### Centre distances for plinth fixing

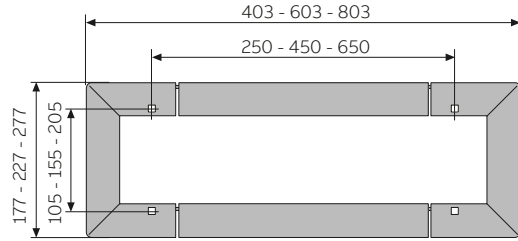

### Internal counterdoors

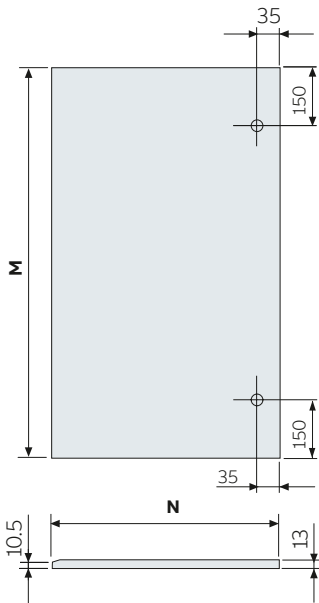

Code	M	N
KC5040K *	456	360
KC6040K *	556	360
KC7050K *	656	460
KC8060K	756	560
KC1060K	956	560
KC1080K	956	760
KC1260K	1156	560
KC1280K	1156	760

\* The counterdoors with H 500 mm, 600 mm and 700 mm, only have one hole in the centre for the lock

### Internal plates

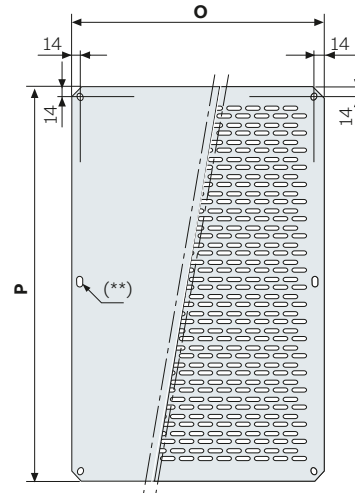

Code	O	P
PF3020	160	260
PF3030	260	260
PF3040 - PF4030	360	260
PF4040	360	360
PF5030	260	460
PF5040	360	460
PF6040 - PF4060	360	560
PF6060	560	560
PF7050	460	660
PF8060	560	760
PF8080	760	760
PF1060	560	960
PF1080	760	960
PF1260	560	1160
PF1280	760	1160

—  
10

**SRX**



**SRX**  
Index

<b>SRX</b>	
Overall dimensions	258
Enclosures	260
General characteristics and applications	262
Selection of the structure	264
Ordering codes	265
Overall dimensions - Drillings	275

# General purpose enclosures technical details

## SRX - Overall Dimensions

### Basic version

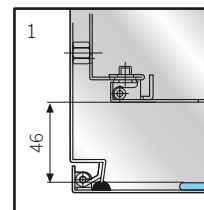
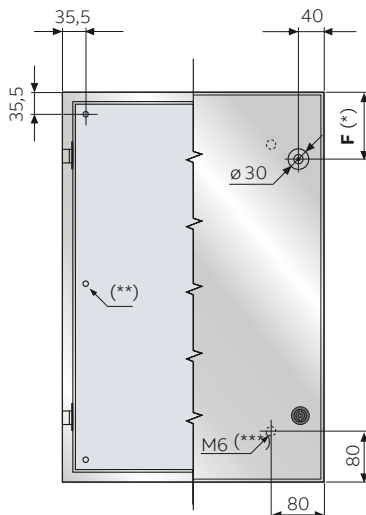
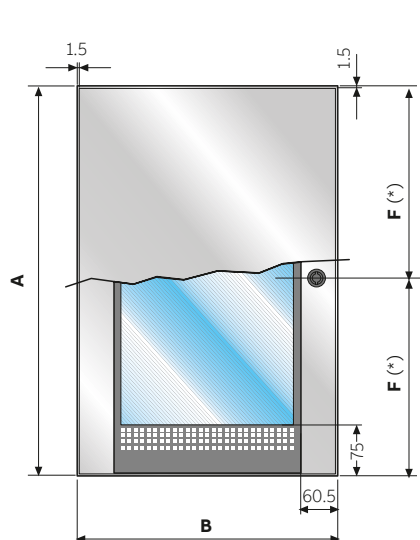

(\*) Locks (F)  
 1 central for enclosures from h=303 to 503 mm  
 2 for enclosures from h=603 to 703 mm (F=100mm)  
 2 for enclosures from h=803 to 1203 mm (F=150mm)

(\*\*) Copper plated nut on the rear only for enclosures from h=1003 to 1203 mm

(\*\*\*) Copper plated nut on door  
 1 for enclosures from h=303 to 503 mm  
 4 for enclosures from h=603 to 803 mm  
 6 for enclosures from h=1003 to 1203 mm

### Modular panels and inner door

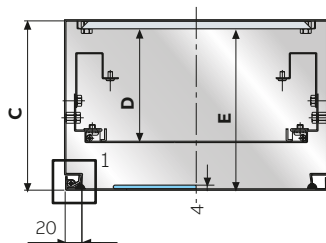

Code	A	B	C	D	E	F(*)	G	H	I	L
SRN3215X	303	203	147	82	133,5	151,5	163	337	237	263
SRN3415X	303	403	147	82	133,5	151,5	363	337	437	263
SRN4315X	403	303	147	82	133,5	201,5	263	437	337	363
SRN4320X	403	303	197	132	183,5	201,5	263	437	337	363
SRN4420X	403	403	197	132	183,5	201,5	363	437	437	363
SRN4620X	403	603	197	132	183,5	201,5	563	437	637	363
SRN5420X - SRN5420VX	503	403	197	132	183,5	251,5	363	537	437	463
SRN5520X	503	503	197	132	183,5	251,5	363	537	437	463
SRN6420X - SRN6420VX	603	403	197	132	183,5	100	363	637	437	563
SRN6620X	603	603	197	132	183,5	100	363	637	437	563
SRN6630X	603	603	297	232	283,5	100	363	637	437	563
SRN7525X - SRN7525VX	703	503	247	182	233,5	100	463	737	537	663
SRN8620X	803	603	197	132	183,5	150	363	637	437	563
SRN8625VX	803	603	247	182	233,5	150	563	837	637	763
SRN8630X	803	603	297	232	283,5	150	563	837	637	763
SRN8830X	803	803	297	232	283,5	150	763	837	837	763
SRN10830X - SRN10830VX	1003	803	297	232	283,5	150	763	1037	837	963
SRN12630X	1203	603	297	232	283,5	150	563	1237	637	1163
SRN12830X	1203	803	297	232	283,5	150	763	1237	837	1163

Measurements are expressed in millimeters.

# General purpose enclosures technical details

## SRX - Overall Dimensions

### Centre distances for wall-mounting

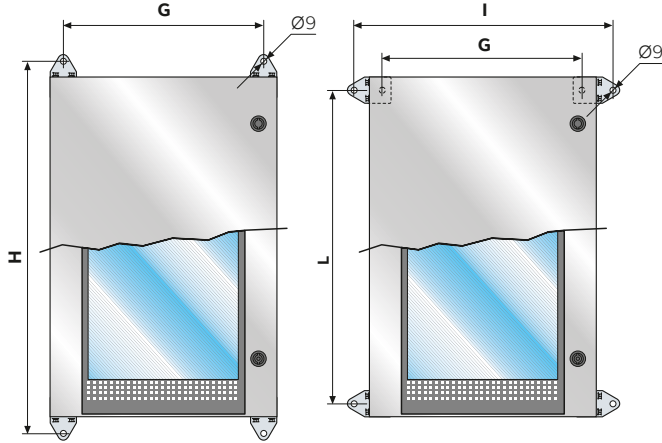

### Centre distances for plinth fixing

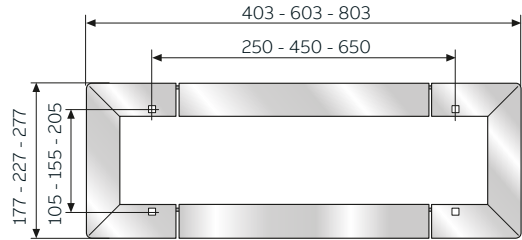

### Inner doors

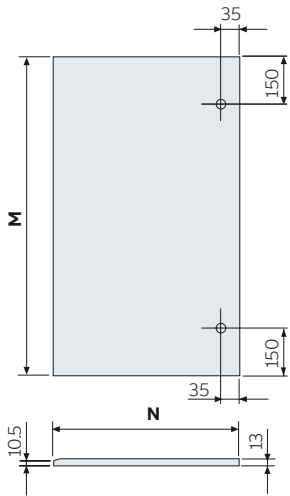

Code	M	N
KC5040X*	456	360
KC6040X*	556	360
KC7050X*	656	460
KC8060X	756	560
KC1080X	956	760

### Internal plates

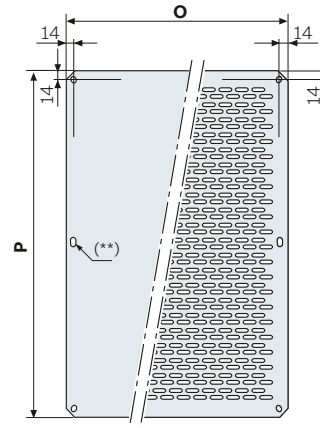

Code	O	P
PF3020	160	260
PF3030	260	260
PF3040 - PF4030	360	260
PF4040	360	360
PF5030	260	460
PF5040	360	460
PF5050	460	460
PF6040 - PF4060	360	560
PF6060	560	560
PF7050	460	660
PF8060	560	760
PF8080	760	760
PF1060	560	960
PF1080	760	960
PF1260	560	1160
PF1280	760	1160

\* Inner doors with H 500mm, 600mm, 700mm only have one hole in the centre for the lock

## General purpose enclosures technical details

### SRX - enclosures

#### Dissipating power

##### SR enclosures

Dissipating power inside the SR enclosures according to the permissible overtemperature (external temperature plus overtemperature = 60 °C max).

#### Maximum dissipating power (W)

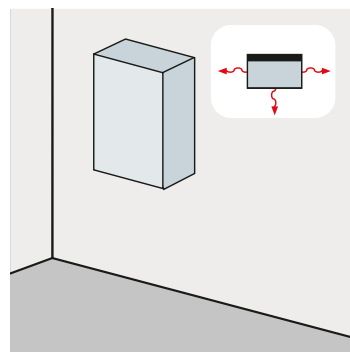

Wall-mounted single enclosure

Code	Dimensions			Overtemperature values $\Delta T$			
	H (mm)	W (mm)	D (mm)	25 °C	30 °C	35 °C	40 °C
SRN3215K	300	200	150	18	22	26	31
SRN3315K	300	300	150	23	29	35	42
SRN3415K	300	400	150	34	42	51	60
SRN4315K	400	300	150	30	37	45	53
SRN4320K	400	300	200	33	42	51	60
SRN4420K	400	400	200	42	52	63	74
SRN4620K	400	600	200	59	74	89	105
SRN5320K	500	300	200	39	49	59	69
SRN5420K	500	400	200	47	59	72	85
SRN5420VK	500	400	200	47	59	72	85
SRN5425K	500	400	250	52	66	79	94
SRN5425VK	500	400	250	52	66	79	94
SRN6420K	600	400	200	54	67	82	96
SRN6420VK	600	400	200	54	67	82	96
SRN6425K	600	400	250	59	74	89	105
SRN6425VK	600	400	250	59	74	89	105
SRN6625K	600	600	250	79	99	120	141
SRN7520K	700	500	200	68	86	104	122
SRN7520VK	700	500	200	68	86	104	122
SRN7525K	700	500	250	74	93	113	133
SRN7525VK	700	500	250	74	93	113	133
SRN8625K	800	600	250	94	118	143	169
SRN8625VK	800	600	250	94	118	143	169
SRN8630K	800	600	300	107	134	162	191
SRN8630VK	800	600	300	107	134	162	191
SRN8830K	800	800	300	114	142	173	204
SRN10625K	1000	600	250	95	118	143	169
SRN10625VK	1000	600	250	95	118	143	169
SRN10630K	1000	600	300	103	130	156	185
SRN10630VK	1000	600	300	103	130	156	185
SRN10830K	1000	800	300	142	178	215	254
SRN10830VK	1000	800	300	142	178	215	254
SRN12630K	1200	600	300	123	155	187	220
SRN12630VK	1200	600	300	123	155	187	220
SRN12830K	1200	800	300	168	210	255	300
SRN12830VK	1200	800	300	168	210	255	300

Values also valid for the versions with glazed door.

## General purpose enclosures technical details

### SRX - enclosures

#### Dissipating power

##### SRX enclosures

Dissipating power inside the SRX enclosures according to the permissible overtemperature (external temperature plus overtemperature = 60 °C max).

#### Maximum dissipating power (W)

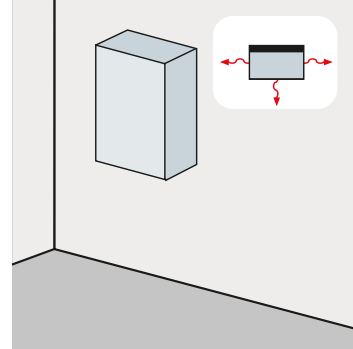

Wall-mounted single enclosure

Code	Dimensions			Overtemperature values $\Delta T$			
	H (mm)	W (mm)	D (mm)	25 °C	30 °C	35 °C	40 °C
SRN3215X	300	200	150	29	35	42	50
SRN3415X	300	400	150	55	68	82	97
SRN4315X	400	300	150	48	60	72	85
SRN4320X	400	300	200	53	68	82	97
SRN4420X	400	400	200	68	84	101	119
SRN4620X	400	600	200	95	119	143	169
SRN5420X	500	400	200	76	95	116	137
SRN5420VX	500	400	200	76	95	116	137
SRN5520X	500	500	200	-	-	-	-
SRN6420X	600	400	200	87	108	132	154
SRN6420VX	600	400	200	87	108	132	154
SRN6620X	600	600	200	-	-	-	-
SRN6630X	600	600	300	-	-	-	-
SRN7525X	700	500	250	119	150	182	214
SRN7525VX	700	500	250	119	150	182	214
SRN8620X	800	600	200	-	-	-	-
SRN8625VX	800	600	250	151	190	230	272
SRN8630X	800	600	300	172	216	261	307
SRN8830X	800	800	300	183	228	278	328
SRN10830X	1000	800	300	228	286	346	409
SRN10830VX	1000	800	300	228	286	346	409
SRN12630X	1200	600	300	198	249	301	354
SRN12830X	1200	800	300	270	338	410	483

---

## General purpose enclosures

### SRX enclosures - General characteristics and applications

**The AISI 304 stainless steel used allows the cabinets to be installed either indoors or outdoors, by fixing to the floor or a wall. AISI 304 stainless steel enclosures with opaque door, usually intended for making enclosures for automation, are supplied with the galvanised sheet metal internal plate and do not have cable entry flanges.**

SRX enclosures always conform to IEC EN 62208 and to IEC 61439-1-2, have a degree of protection IP66 (IEC EN 60529); NEMA 4X and NEMA 3R (UL standard). The degree of protection against external mechanical impacts is IK10 for the version with opaque door and IK09 for the version with glass door (IEC 62262).

AISI 304 stainless steel enclosures with glass door can also be used for distribution configurations. Alternatively, the

internal equipment is made by selecting special kits (Distribution Kit) consisting of a pair of functional uprights for assembly of the AISI 304 stainless steel modular panels (to be ordered separately) and any compensation panels. The modular panels, which can also be installed on the enclosures with opaque door using the same KD Kit....X, are all hinged and have vertical modularity of 185 mm.



## General purpose enclosures

### SRX enclosures - General characteristics and applications

SRX enclosures can be equipped with: standard plates, clip nuts, spacers, slotted internal plate, accessories for stacking, DIN rails and fixing brackets, shaped sections for accessories on doors, closing systems.



#### Spray protection roof

Improves protection against infiltration by liquids and accidental sprays. Made of AISI 304 stainless steel.



#### Distribution kit

All apparatuses and modular circuit breakers can be installed on a DIN rail combined with a modular panel.



#### Stacking



SRX enclosures can be stacked using the special kit. The plinth with removable flanges is made of 25/10 thick AISI 304 stainless steel.



#### Closing box

A new Ø19 mm closing box made of chrome-finished plastic with double tongue key.

#### Technical characteristics

Conforms to	CEI EN 62208, IEC 61439-1-2
Degree of protection	IP66 (CEI EN 60529) UL Listed: UL 508A NEMA: Types 1, 3R, 4, 4X, 12
Degree of mechanical protection	IK10 opaque door IK09 glass door (IEC 62262)
Certifications	 
Type of material	AISI 304
Installation site	indoors/outdoors
Fixing method	floor/wall
Normal operating conditions - ambient temperature	from -5 to +55°C

## General purpose enclosures

### SRX - Selection of the structure

#### Rapid selection table

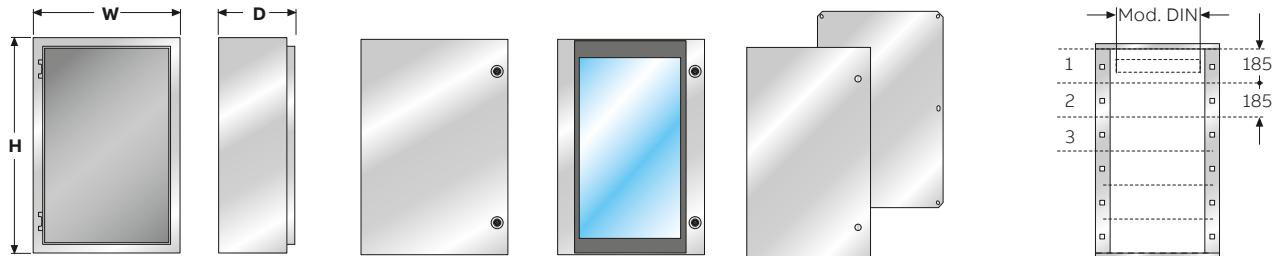

Overall dimensions			Automation kit				Distribution kit Supports for mounting modular panels			
H mm	W mm	D mm	Enclosures with opaque door + mounting plate	Enclosures with transparent door <sup>1</sup>	Opaque inner door IP20	Opaque plate	No. of vertical mod. H=185mm	No. of DIN mod. per row	Total modules	DIN supports
300	200	150	SRN3215X			PF3020				
	400	150	SRN3415X			PF3040				
400	300	150	SRN4315X		KC4030X	PF4030				
		200	SRN4320X							
	400	200	SRN4420X			PF4040				
	600	200	SRN4620X			PF4060				
500	400	200	SRN5420X	SRN5420VX	KC5040X	PF5040	2	14	28	KD5040X
	500	200	SRN5520X			PF5050				
600	400	200	SRN6420X	SRN6420VX	KC6040X	PF6040	3	14	42	KD6040X
		600	200	SRN6620X		PF6060				
	300	SRN6630X								
700	500	250	SRN7525X	SRN7525VX	KC7050X	PF7050				
800	600	200	SRN8620X		KC8060X	PF8060	4	25	100	KD8060X
		250		SRN8625VX				25	100	
		300	SRN8630X					25	100	
	800	300	SRN8830X			PF8080				
1000	800	300	SRN10830X	SRN10830VX	KC1080X	PF1080	5	36	180	KD1080X
1200	600	300	SRN12630X			PF1260				
	800	300	SRN12830X			PF1280				

<sup>1</sup> Mounting plate to be ordered separately.



**General purpose enclosures**

SRX - Ordering codes

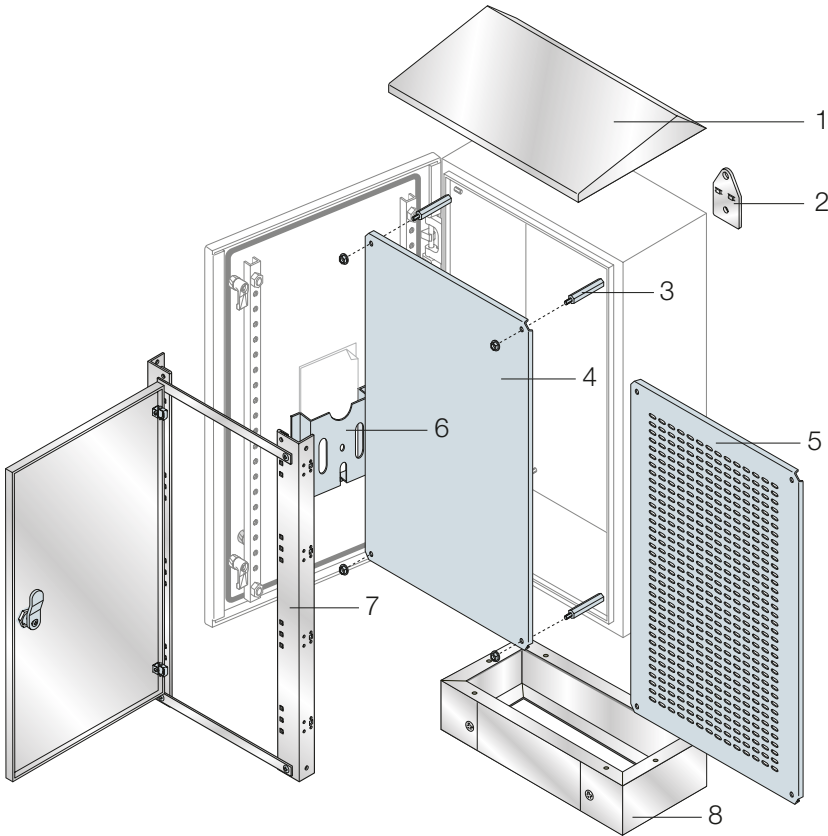

- 1 - Spray protection roof
- 2 - Wall-mounting brackets
- 3 - Spacers for back plates
- 4 - Opaque internal plate
- 5 - Slotted internal plate
- 6 - Document pocket
- 7 - Opaque inner door
- 8 - Plinth

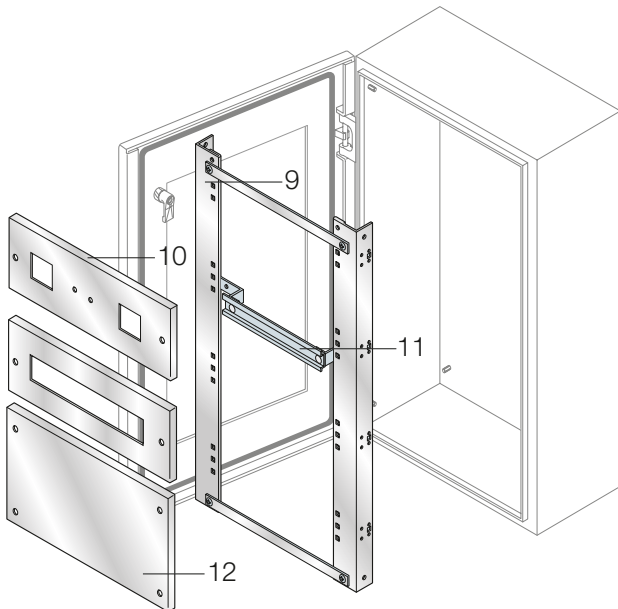

- 9 - Frame for DIN rail
- 10 - Modular panels for apparatuses
- 11 - DIN rail
- 12 - Opaque modular panels

## General purpose enclosures

### SRX - Ordering codes

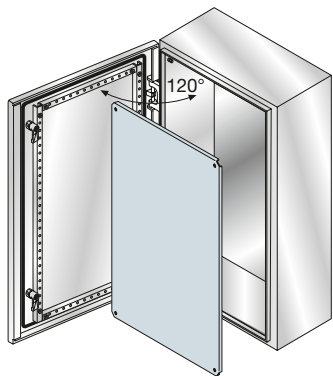

#### SRX series enclosures with opaque door (internal plate included)

Enclosures with an opaque door, made of AISI 304 stainless steel, usually intended for producing enclosures for automation, come supplied with the galvanised sheet metal internal plate and do not have cable entry flanges.

Enclosures with opaque door complete with internal mounting plate						
Dimensions (mm)				Code	Package/ No. of pieces	
H	W	D				
300	200	150		SRN3215X	1/1	
	400			SRN3415X	1/1	
400	300	150		SRN4315X	1/1	
	300		200		SRN4320X	1/1
	400				SRN4420X	1/1
500	600			SRN4620X	1/1	
	400	200		SRN5420X	1/1	
	500			SRN5520X	1/1	
600	400	200		SRN6420X	1/1	
	600			SRN6620X	1/1	
	600		300		SRN6630X	1/1
700	500	250		SRN7525X	1/1	
800	600	200		SRN8620X	1/1	
	600		300		SRN8630X	1/1
	800				SRN8830X	1/1
1000	800	300		SRN10830X	1/1	
1200	600	300		SRN12630X	1/1	
	800			SRN12830X	1/1	

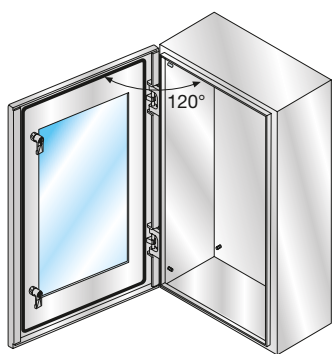

#### SRX series stainless steel enclosures with transparent door

AISI 304 stainless steel enclosures with a glass door can also be used for distribution configurations. The internal equipment is set up using the relevant kits:

- KD...X (Distribution Kit) consisting of a pair of functional uprights for assembly of the modular panels made of AISI 304 stainless steel (to be ordered separately) and of any compensation panels. The modular panels, which can also be installed on the enclosures with opaque door using the KD kit, are all hinged and have vertical modularity of 185 mm. The enclosures with see-through door are provided without mounting plate.

Enclosures with transparent door					
Dimensions (mm)				Code	Package/ No. of pieces
H	W	D			
500	400	200		SRN5420VX	1/1
600	400			SRN6420VX	1/1
700	500	250		SRN7525VX	1/1
800	600			SRN8625VX	1/1
1000	800	300		SRN10830VX	1/1

## General purpose enclosures

### SRX - Ordering codes

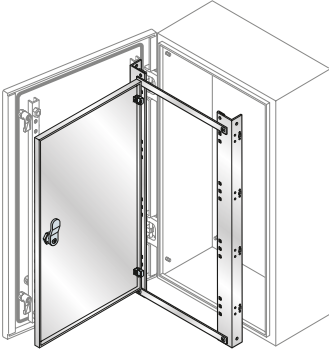

#### Opaque inner door

The inner door guarantees a degree of protection of IP20. Made of 15/10 thick AISI 304 stainless steel, complete with box and double tongue insert.

Opaque inner door			
Dimensions (mm)			Package/ No. of pieces
H	W	Code	
400	300	KC4030X	1/1
500	400	KC5040X	1/1
600		KC6040X	1/1
700	500	KC7050X	1/1
800	600	KC8060X	1/1
1000	800	KC1080X	1/1

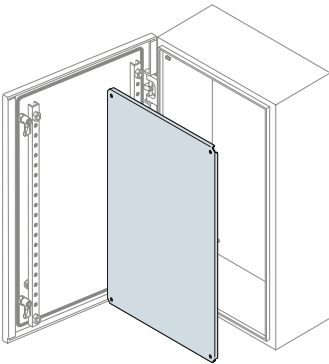

#### Opaque internal mounting plate

20/10 thick galvanised sheet metal internal plate, complete with fixing with small parts supplied. Depth-adjustable using a special spacer kit (to be ordered separately).

Opaque internal mounting plate			
Dimensions (mm)			Package/ No. of pieces
H	W	Code	
300	200	PF3020	1/1
300	400	PF3040	1/1
400	300	PF4030	1/1
400	400	PF4040	1/1
400	600	PF4060	1/1
500	400	PF5040	1/1
500	500	PF5050	1/1
600	400	PF6040	1/1
600	600	PF6060	1/1
700	500	PF7050	1/1
800	600	PF8060	1/1
800	800	PF8080	1/1
1000	800	PF1080	1/1
1200	600	PF1260	1/1
1200	800	PF1280	1/1

## General purpose enclosures

### SRX - Ordering codes

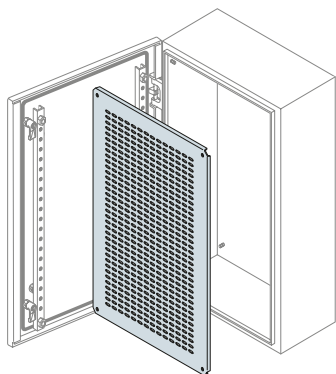

#### Slotted internal plate

Fixing with small parts supplied. Depth-adjustable using a special spacer kit (to be ordered separately).

Piastra interna asolata			
Dimensions (mm)			Package/ No. of pieces
H	W	Code	
300	200	TQ3020	1/1
300	400	TQ3040	1/1
400	300	TQ4030	1/1
400	400	TQ4040	1/1
400	600	TQ4060	1/1
500	400	TQ5040	1/1
600	400	TQ6040	1/1
600	600	TQ6060	1/1
700	500	TQ7050	1/1
800	600	TQ8060	1/1
800	800	TQ8080	1/1
1000	800	TQ1080	1/1
1200	600	TQ1260	1/1
1200	800	TQ1280	1/1

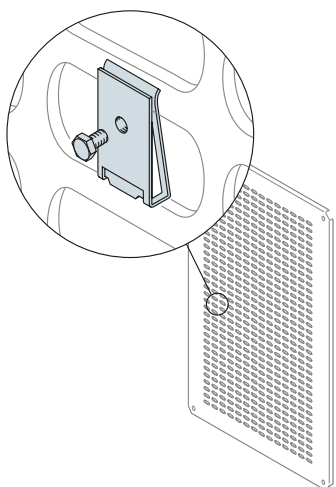

#### Clip nuts

For slotted plates with M6x10mm hexagonal head screws.

Description	Code	Package/ No. of pieces
Clip nuts	TQ6610	1/20

#### Spacer kit for adjusting back plate depth

Kit made up of 12 spacers for fixing the mounting plate. Allows depth adjustment in 25 mm steps.

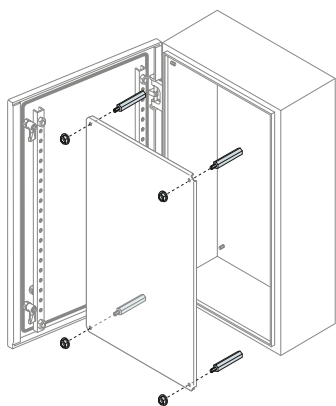

Description	Code	Package/ No. of pieces
Spacers, length 25 mm	AA8025	1/12
Spacers, length 50 mm	AA8050	1/12

## General purpose enclosures

### SRX - Ordering codes

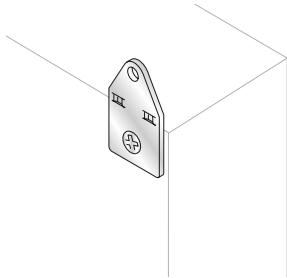

#### Wall-mounting brackets

Allow enclosures to be wall-mounted and are fitted using the special holes located on the back of the enclosures. Made of 30/10 thick AISI 304 stainless steel.

Description	Code	Package/ No. of pieces
No. 4 wall-mounting brackets	AA1206X	1/4

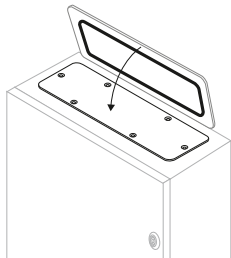

#### Fairlead plates

Fairlead plates in 25/10 thick AISI 304 stainless steel with polyurethane gasket.

Description	Dimensions (mm)		Code	Package/ No. of pieces
	W	D		
Fairlead plate) for SRN3215X	173	97	FLN3215X	1/1
Fairlead plate for SRN4315X	273	97	FLN4315X	1/1
Fairlead plate for SRN3415X	373	97	FLN3415X	1/1
Fairlead plate for SRN4320X, SRN4320VX	273	147	FLN4320X	1/1
Fairlead plate for SRN4420X, SRN5420X, SRN6420X, SRN5420VX, SRN6420VX	373	147	FLN4420X	1/1
Fairlead plate 500x200mm for SRN5520X	473	147	FLN5520X	1/1
Fairlead plate) for SRN4620X, SRN6620X, SRN8620X	573	147	FLN4620X	1/1
Fairlead plate for SRN7525X, SRN7525VX	473	197	FLN7525X	1/1
Fairlead plate for SRN8625VX	573	197	FLN8625X	1/1
Fairlead plate for SRN6630X, SRN8630X, SRN12630X	573	247	FLN6630X	1/1
Fairlead plate for SRN6830X, SRN8830X, SRN10830X, SRN12830X, SRN10830VX	773	247	FLN6830X	1/1

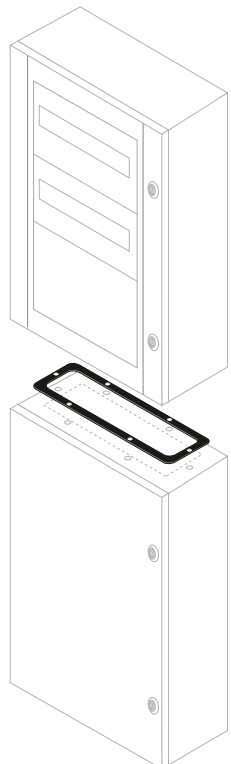

#### Accessories for stacking

Dimensions (mm)			Package/ No. of pieces
W	D	Code	
<b>IP65 gasket</b>			
400	200	GZ4020	1/1
500	200	GZ5020	1/1
	250	GZ5025	1/1
600	200	GZ6020	1/1
	250	GZ6025	1/1
	300	GZ6030	1/1
800	300	GZ8030	1/1

## General purpose enclosures

### SRX - Ordering codes

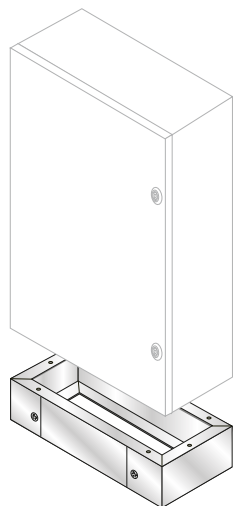

#### Plinth

25/10 thick AISI 304 stainless steel plinth.

Plinth					
Dimensions (mm)				Code	Package/ No. of pieces
H	W	D			
100	400	200		ZA4020X	1/1
100	500	200		ZA5020X	1/1
100		250		ZA5025X	1/1
100	600	200		ZA6020X	1/1
100		300		ZA6030X	1/1
100	800	300		ZA8030X	1/1

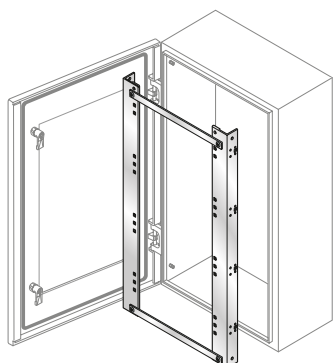

#### Frame for DIN rail

Internal supports for fixing modular panels and DIN rails, with compensation panels, made of AISI 304 stainless steel.

Description	Dimensions (mm)		Code	Package/ No. of pieces
	H	W		
Supports for 14 DIN mod. x 2 rows	500	400	KD5040X	1/1
Supports for 14 DIN mod. x 3 rows	600	400	KD6040X	1/1
Supports for 25 DIN mod. x 4 rows	800	600	KD8060X	1/1
Supports for 36 DIN mod. x 5 rows	1000	800	KD1080X	1/1

## General purpose enclosures

### SRX - Ordering codes

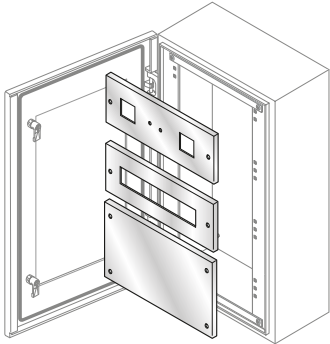

#### Screwed modular panels

12/10 mm thick AISI 304 stainless steel modular panels. The screwed modular panels can be fitted on the enclosures using the special kit (KD...) consisting of functional uprights and a compensation panel.

Each modular panel (PM) comes equipped with a DIN rail (depth-adjustable), fixing brackets and the relative small parts. Tmax modular and moulded-case circuit breakers up to T3 can be positioned side by side on the same DIN rail using the special depth adapter AP 6001. To install MCCBs, fix the DIN rail in the recessed position. The DIN rail fixing brackets allow mounting of the wiring duct up to a maximum size of 60 x 60 mm.

#### Stainless steel screwed modular panels for DIN rail (including DIN rail and fixing brackets)

Description	Dimensions (mm)		Code	Package/ No. of pieces
	H	W		
14 DIN mod. + fixing bracket	185	400	PM1414X	1/1
25 DIN mod. + fixing bracket	185	600	PM1625X	1/1
36 DIN mod. + fixing bracket	185	800	PM1836X	1/1

#### Stainless steel screwed modular panels for measuring instruments

Description	Dimensions (mm)		Code	Package/ No. of pieces
	H	W		
2 instruments 72 x 72mm	185	400	PS2476X	1/1
2 instruments 72 x 72mm	185	600	PS2676X	1/1
2 instruments 72 x 72mm	185	800	PS2876X	1/1

#### Stainless steel opaque screwed modular panels

Description	Dimensions (mm)		Code	Package/ No. of pieces
	H	W		
Opaque panel	185	400	PC1406X	1/1
Opaque panel	185	600	PC1606X	1/1
Opaque panel	185	800	PC1806X	1/1
Opaque panel	370	600	PC2606X	1/1
Opaque panel	370	800	PC2806X	1/1

#### Shaped sections for accessories

Allow fixing of accessories (e.g.: wiring ducts) inside the blind doors. Consist of a pair of vertical crosspieces made of 15/10 thick white galvanised sheet metal, pre-drilled with 25 mm pitch. In enclosures with height 1000 and 1200 mm with a blind door, the shaped sections are already supplied.

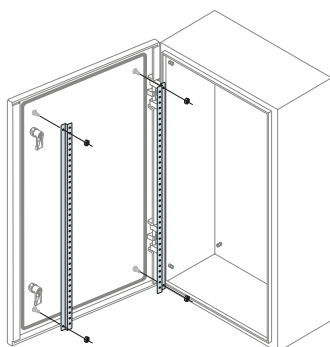

Description	Dimensions (mm)		Code	Package/ No. of pieces
	H	W		
Shaped sections for door	600		TS6009	1/2
Shaped sections for door	700		TS7009	1/2
Shaped sections for door	800		TS8009	1/2

## General purpose enclosures

### SRX - Ordering codes

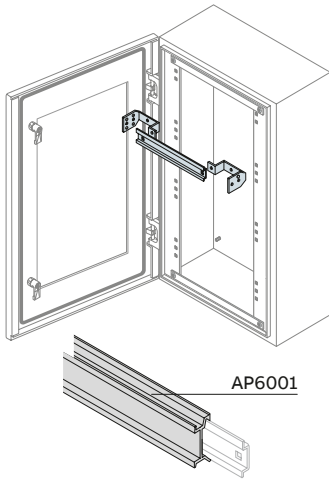

#### DIN rail and fixing brackets

Description	No. modules	W (mm)	Code	Package/ No. of pieces
DIN rail and fixing brackets	14	400	GD4006	1/1
DIN rail and fixing brackets	25	600	GD6006	1/1
DIN rail and fixing brackets	36	800	GD8006	1/1
<b>Depth adapter</b>				
No.1 depth adapter for Tmax T1-T2-T3-XT1-XT3 W = 600 mm			AP6001	1/4

#### Spray protection roof

Improves protection against infiltration by liquids and accidental sprays.  
Made of 15/10 thick AISI 304 stainless steel.

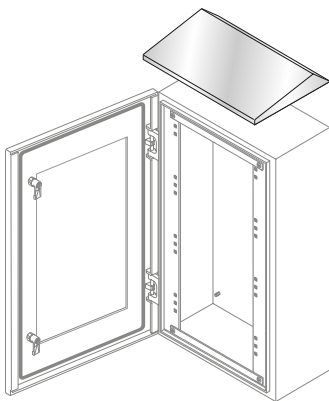

#### Spray protection roof

Dimensions (mm)			Package/ No. of pieces
W	D	Code	
200	150	TT2015X	1/1
300	150	TT3015X	1/1
400	150	TT4015X	1/1
300	200	TT3020X	1/1
400	200	TT4020X	1/1
500	200	TT5020X	1/1
600	200	TT6020X	1/1
500	250	TT5025X	1/1
600	250	TT6025X	1/1
600	300	TT6030X	1/1
800	300	TT8030X	1/1

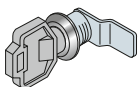

AA8001X

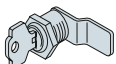

AA8002

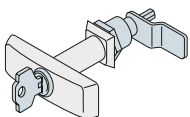

AA8003



EV1008

#### Closing systems

May substitute standard fasteners for the external doors.

Description	Code	Package/ No. of pieces
Box Ø 19 mm double tongue made of chrome-finished plastic and key for external door	AA8001X	1/1
Box Ø 19 mm with safety insert and Yale type key for external door	AA8002 <sup>(1)</sup>	1/1
Box Ø 19 mm with handle and Yale type key for external door	AA8003 <sup>(1)</sup>	1/1
Box Ø 19 mm with triangular insert for external door	AA5200 <sup>(1)</sup>	1/1
Plastic key for triangular insert AA5200 for external door	AA5190	1/1
Box with double tongue insert made of plastic with key for inner door (without tongue)	EV1008	1/1
Single code Yale insert for inner door	EV1036	1/1
Ronis 455 insert for inner door	EV1037	1/1
3mm double tongue insert for inner door	EV1039	1/1

<sup>(1)</sup> Only for external door



## General purpose enclosures

### SRX - Ordering codes

#### Spare parts

Description	Code	Package/ No. of pieces
Stainless steel screws (No. 16 screws, flanged nuts and nylon washers M6)	AA1203X	1/1
Opaque door 300x200 mm (HxW)	PRN3026X	1/1
Opaque door 300x400 mm (HxW)	PRN3046X	1/1
Opaque door 400x300 mm (HxW)	PRN4036X	1/1
Opaque door 400x400 mm (HxW)	PRN4046X	1/1
Opaque door 400x600 mm (HxW)	PRN4066X	1/1
Opaque door 500x400 mm (HxW)	PRN5046X	1/1
Opaque door 500x500 mm (HxW)	PRN5056X	1/1
Opaque door 600x400 mm (HxW)	PRN6046X	1/1
Opaque door 600x600 mm (HxW)	PRN6066X	1/1
Opaque door 600x800 mm (HxW)	PRN6086X	1/1
Opaque door 700x500 mm (HxW)	PRN7056X	1/1
Opaque door 800x600 mm (HxW)	PRN8066X	1/1
Opaque door 800x800 mm (HxW)	PRN8086X	1/1
Opaque door 1000x800 mm (HxW)	PRN1086X	1/1
Opaque door 1200x600 mm (HxW)	PRN1266X	1/1
Opaque door 1200x800 mm (HxW)	PRN1286X	1/1
Glass door 400x300 mm (HxW)	PTN4036X	1/1
Glass door 500x400 mm (HxW)	PTN5046X	1/1
Glass door 600x400 mm (HxW)	PTN6046X	1/1
Glass door 700x500 mm (HxW)	PTN7056X	1/1
Glass door 800x600 mm (HxW)	PTN8066X	1/1
Glass door 1000x800 mm (HxW)	PTN1086X	1/1

## General purpose enclosures

### SRX - Ordering codes

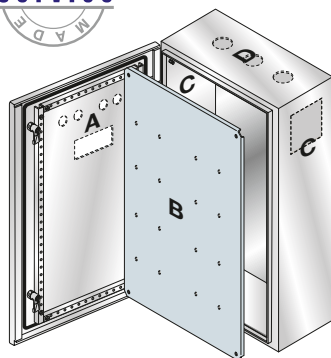

#### Special Drilling Service

The overprice amount depends on the number of individual drilled parts and not on the number of holes.

For single part it means: A-door B-plate; C-housing; D-top/bottom part.

Please note that the minimum quantity is 10 pieces with a single code. The price of the special drilling service depends on the number of parts to be drilled and on the amount of enclosures to be drilled.

Description	Code	No. of enclosures to be drilled
Extra cost for drilling service per individual drilled part (A-B-C-D)	FORSRX	≥ 10

The special drilling service for standard size enclosures in quantities equal to or greater than 10 units with a single code has to be managed with code SRN ... SPEC + overprice FORSR/ FORSR1/FORSSR2 (see table) equal to the number of enclosures and the number of parts to be drilled + hole layout to be attached to the order.

**Example: SRN4320XSPEC 10  
FORSRX 10**

**Example: Enclosure (10 pcs) with door and plate to be drilled (2 parts)  
SRN4320XSPEC 10  
FORSRX 20  
DRAWINGS TO BE ATTACHED**

#### Non-standard enclosure sizes, special drilling

Request feasibility of implementation by completing the relevant Form for special quotations and send it together with the drill layout to the R&D ECS office. Management is per offer. If the offer is accepted and after having received it, it will be possible to place the order with the codes indicated in the offer.



#### Painting Special Service

Request feasibility of implementation by completing the relevant Form for special quotations and send it to the R&D ECS office. Management is per offer.

If the offer is accepted and after having received it, it will be possible to place the order with the codes indicated in the offer.

# General purpose enclosures

## SRX - Overall Dimensions - Drillings

### SRX enclosure drilling

Maximum working dimensions for drilling.

Flanges

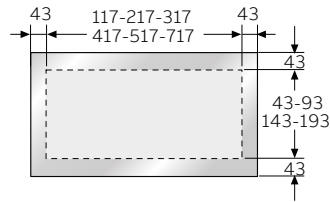

Side

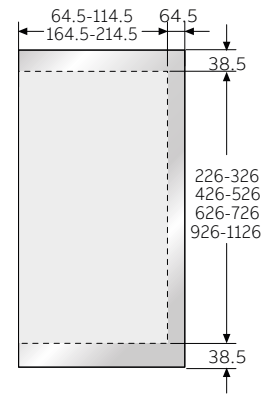

Doors H = 300-400-500

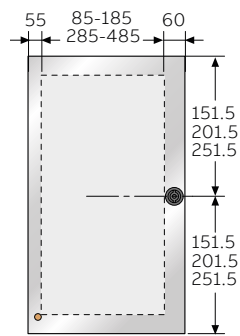

Doors H = 600-700-800

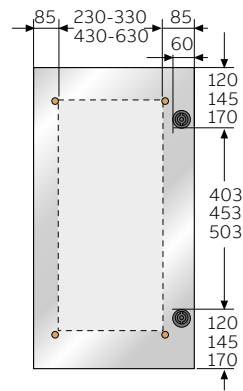

Doors H = 1000-1200

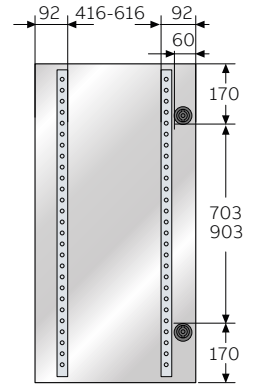



—

**ABB Ltd.**

Electrification

Smart Buildings

Electrical Distribution

**[new.abb.com/low-voltage](https://new.abb.com/low-voltage)**