



GEH5684 INSTALLATION INSTRUCTIONS

Variable Depth Operating Mechanisms

For Spectra RMS™ and E150 Circuit Breakers,
Cat. Nos. SDOM1A, SDOM3, SDOM4 and SDOM6



WARNING: Danger of electrical shock or injury. Turn **OFF** power ahead of the device before lug installation or modification. Do Not remove circuit protective devices until the power is turned **OFF**.

GENERAL

These variable depth operating mechanisms are for use with flanged enclosures whose minimum depth, measured from mounting surface of operating mechanism to handle mounting surface is given in Figure 2. Maximum standard depth is 18 3/4 inches for the SDOM1A, SDOM3 and SDOM4. Optional 22 inch rod will accommodate 24 inch deep enclosures and is standard in the SDOM6.

The operating mechanism is to be driven by the Type STOA family of flange-mounted operating handles. The mechanism may be field-converted to left hand operation.¹

Mechanism Cat. No.	For Spectra RMS Series
SDOM1A	SE150, TEB, TEC, TED, THED
SDOM1A w/SDOM1AP	TB1, TEC w/TECL
SDOM3	SF250
SDOM4	SG600
SDOM6	SK800/1200

INSTALLATION OF OPERATING MECHANISM-(SEE FIGURE 1.)

1. If the operating mechanism is to be used for right hand operation proceed to Step 2. If operating mechanism is to be used for left hand operation, remove E- ring (2), and drive stud (3) from right side of yoke (4), and reassemble to left side of yoke.
2. Refer to Figure 2 and Table 1 for the necessary details to install the operating mechanism to the enclosure subplate. Table 1 provides the reference dimensions to determine the required wire bending space between the breaker line lugs and the enclosure end wall.
3. Drill and tap the required operating mechanism mounting holes as indicated in Figure 2.
4. For TB1 and TEC with TECL applications, assemble the SDOM1AP plate to the operating mechanism using the #10-32 hardware provided as shown in Figure 1A.

¹ SDOM4 is currently not field-convertible to left hand operation

5. Install the Type STDA flange handle per instruction sheet GEH-5314.
6. Install the operating mechanism (1) on the enclosure subplate using the screws and lockwashers (5) provided (refer to Table 2).
7. Refer to Figure 2 and determine "D" dimension, which is the distance from the handle mounting surface to the operating mechanism mounting surface. Cut drive rod (9) (see Figure 1) 2 1/4 inches shorter in overall length than "D" dimension. The minimum "D" dimension is given in Figure 2.
8. Refer to Figure 1 and thread rod (9), into drive stud (3), until it is about flush with the opposite side of the stud (approximately 10 full turns).
9. With handle and mechanism yoke (4) in OFF position, place small hole in upper end of rod over stud in handle drive link (10).
10. **For SDOM1A, SDOM3 and SDOM4:**
Assemble pin (11) through handle drive link and then through hole in rod. Place washer (12) over pin and assemble cotter pin (13) through hole in pin. Do not bend cotter pin at this time. Slight movement of handle may be necessary to align pin and hole.
For SDOM6:
Assemble handle drive arm to drive rod using 1/4 -20 x 5/8" hex hd screws and lockwashers, (18, 19), 2 places, 1 inch apart. Tighten screws.

INSTALLATION OF SPECTRA RMS OR E150 CIRCUIT BREAKER

1. Move STDA handle to ON position. KEEP HANDS AWAY FROM MECHANISM.
2. Turn circuit breaker to ON position.
3. Using mounting hardware provided (7), (refer to Table 2) install the circuit breaker to the operating mechanism.
4. For SDOM1A & SDOM3 devices, assemble the yoke toggle plates (6 & 6A) to the top of the yoke {use four 1/4-20 x 7/16 slotted screws (8) and four washers (12)} with the handle flange facing toward the breaker. Allow 1/32 inch to 1/16 inch clearance to the circuit breaker handle.

5. For SDOM4, SDOM6 devices, assemble the yoke toggle plates (6 & 6A) to the top of the yoke {use four 1/4-20 x 7/16 slotted screws (8) and four washers (12)} with the plate handle flange facing away from the circuit breaker. Allow 1/32 to 1/16 inch clearance to the circuit breaker.
6. Attempt to turn OFF breaker using flange handle. If breaker does not toggle to OFF position, disconnect drive rod from handle and thread rod one turn clock wise further into drive stud. Reassemble rod to handle.
7. Attempt to turn on breaker. If breaker does not turn ON, readjust toggle plate (6A), closer to breaker toggle handle.
8. With the breaker in the ON position, use the TRIP button to open the breaker. Attempt to RESET breaker by moving the STDA handle to the OFF (Reset) position. If circuit breaker is RESET, it can be turned ON and OFF. If breaker will not reset, repeat Step 6.
9. Again turn ON breaker and repeat Step 8.
10. Once OFF, RESET and ON positions are working properly, bend legs of cotter pin to secure in place.

11. Assemble handle bias spring (14), included with flange handle.
12. Tighten all hardware as follows:

#8-32	20-25 in.-lbs.
#12-24	30-35 in.-lbs.
1/4-20	45-50 in.-lbs.
5/16-18	90-100 in.-lbs.

INSTALLATION OF FLANGE STIFFENER-SDOM4 ONLY

1. Cut the flange stiffener rod (17) 3 7/8 inch shorter than the "D" dimension shown in Figure 2.
2. Assemble flange stiffener rod to top of mechanism (see Figure 1A) using drive pin (11), washer (12), cotter pin (13) and 3/8 inch nuts and lockwashers (15 & 16). Tighten nuts to 100-150 in.-lbs.

INSTALLATION OF FLANGE STIFFENERS-SDOM6 ONLY (see Figure 1B)

1. Cut the two flange stiffener rods 3 7/8 inch shorter than the "D" dimension shown in Figure 2.
2. Assemble per step 2 above, using Figure 1B.

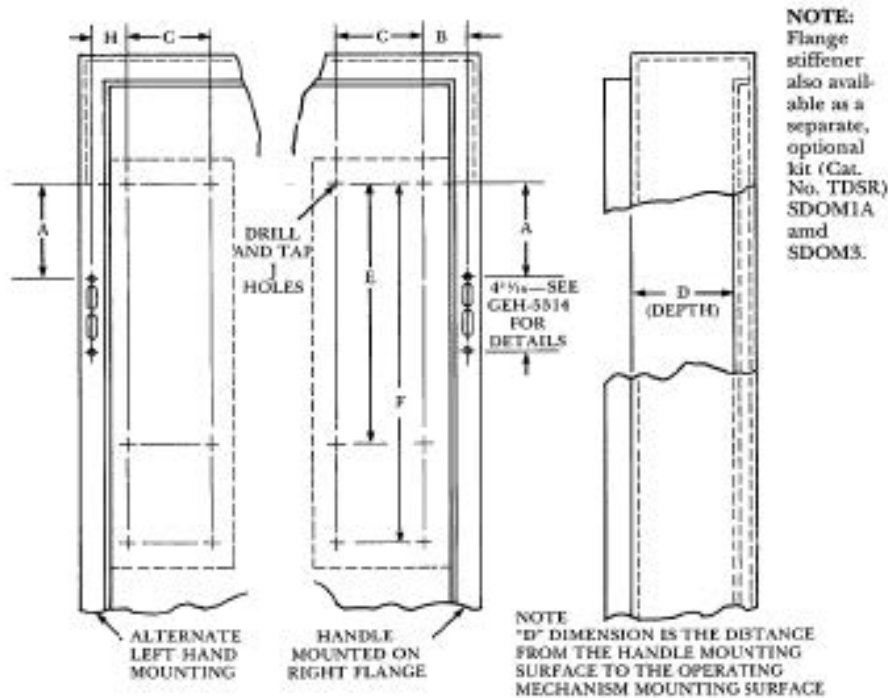









Catalog No.	A		B		C		DMIN		E		F		H		J
	IN.	MM.	IN.	MM.	IN.	MM.	IN.	MM.	IN.	MM.	IN.	MM.	IN.	MM.	
SDOM1A	1.62	41	1.78	45.5	3.00	76.2	6.5	165.1	-	-	6.75	171.5	1.47	37.5	(4) 1/4-20
SDOM3	1.22	31	2.72	69	2.75	69.8	6.5	165.1	-	-	10.88	276	1.03	26.2	(4) 1/4-20
SDOM4	3.22	82	2.38	2.38	3.35	85	8	203.2	5.51	140	12.20	310	2.05	52	(6) 1/4-20
SDOM6	6.00	152.4	2.66	67.5	5.50	139.7	12.00	304.8	9.75	247.6	16.75	425.4	2.34	59.4	(6) 1/4-20

Figure 2. Customer subpanel layout and drilling for left or right mounting.

SEE BACK FOR FULL SIZE TEMPLATE.

TOTAL

- (4)  SDOM1A TAPPED HOLE
- (2)  SDOM1A .28 DIA HOLE FOR HANDLE
- (4)  SDOM3 TAPPED HOLE
- (2)  SDOM3 .28 DIA HOLE FOR HANDLE
- (6)  SDOM4 TAPPED HOLE
- (2)  SDOM4 .28 DIA HOLE FOR HANDLE
- (6)  SDOM6 TAPPED HOLE
- (2)  SDOM6 .28 DIA HOLE FOR HANDLE

*ALL TAPPED HOLES TO BE 1/4-20



UP

SDOM1A TAPPED HOLE
SDM03 TAPPED HOLE
SDOM4 TAPPED HOLE
SDOM6 TAPPED HOLE



Figure 1A. For SDOM1A, SDOM3 and SDOM4

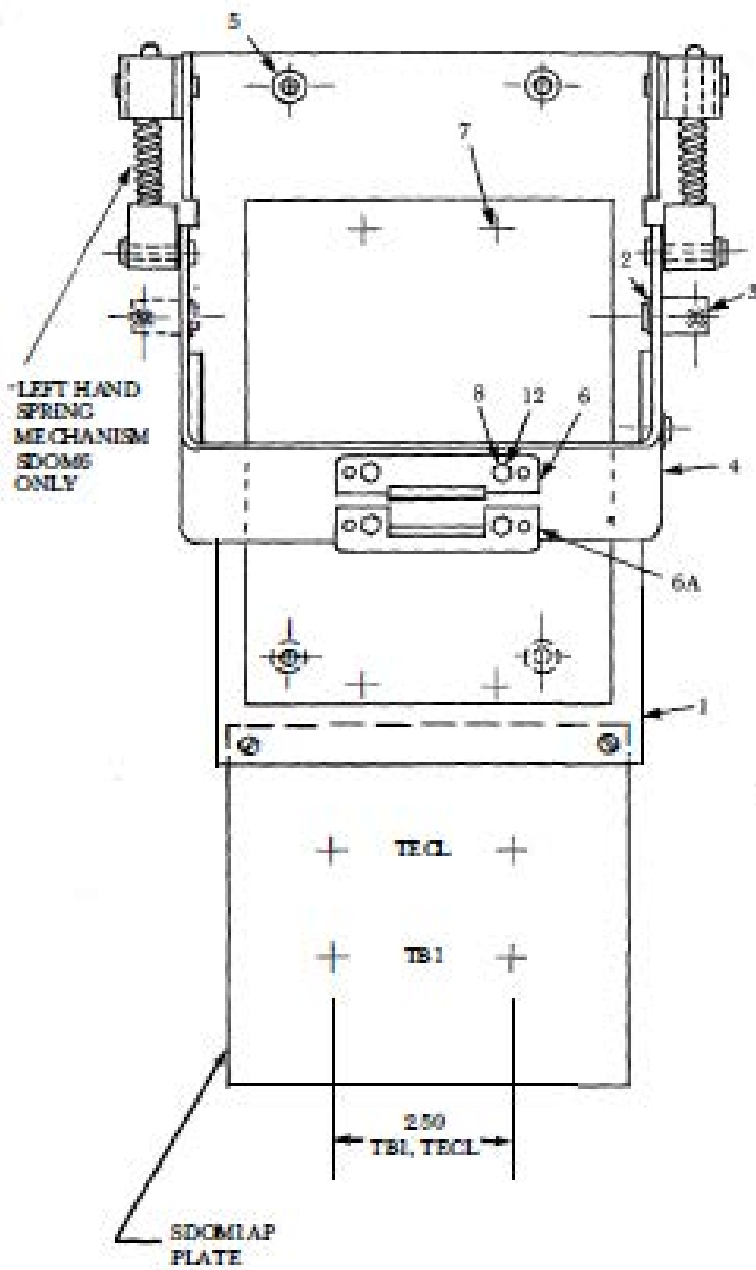

* FLANGE STIFFENER PROVIDED AS STANDARD WITH OPERATING MECHANISMS CAT. NO. SDOM1. ALSO AVAILABLE AS A SEPARATE ORDER ITEM OPTION FOR SDOM1A AND SDOM3.

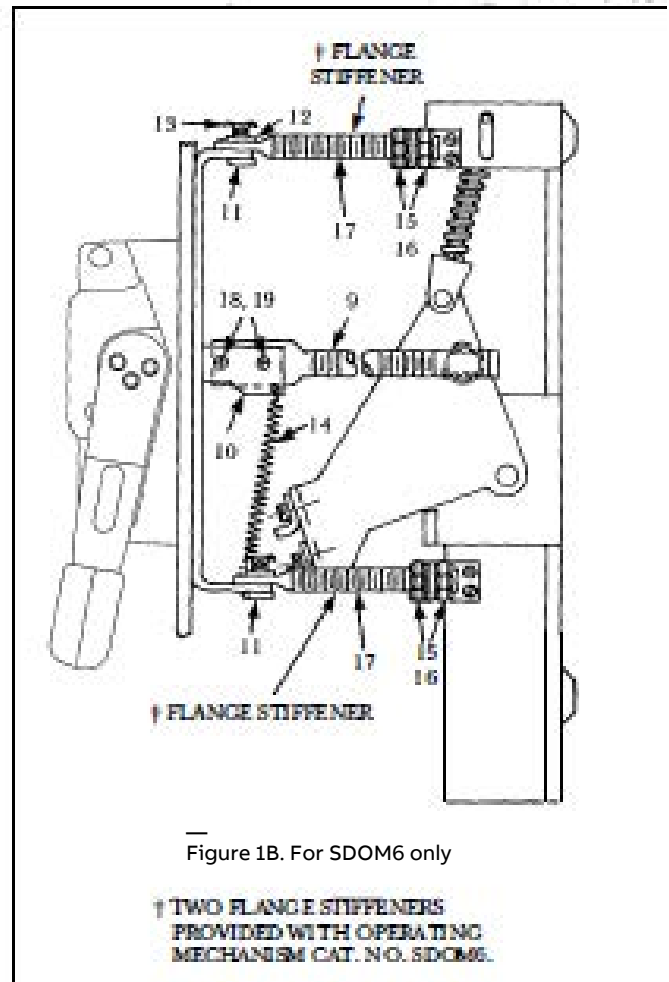
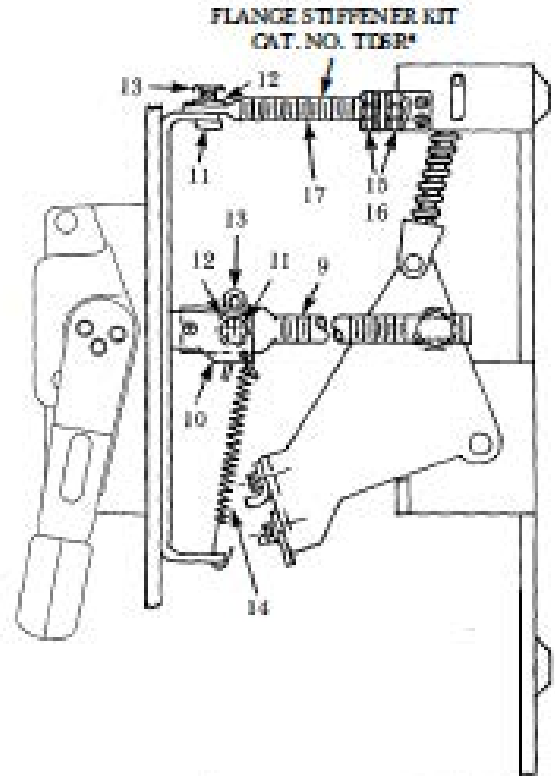

Figure 1B. For SDOM6 only

† TWO FLANGE STIFFENERS PROVIDED WITH OPERATING MECHANISM CAT. NO. SDOM6.

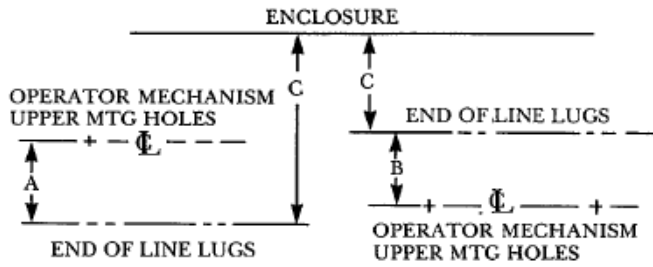

Table 1. Wire bending space reference dimensions.

Cat. No.	A	B	C	
SDOM1A	2.25	-	Wire Bending Space Determined by Customer Application	
SDOM3	.88			
SDOM4	-			.12
SDOM6				1.81

Table 3. Kit Contents & Replacement Parts-(See Figure 1.)

Item No.	Description	Part Number	Quantity Required			
			SDOM1A	SDOM3	SDOM4	SDOM6
1	Complete Assembly	Order Complete Catalog No.	1	1	1	1
2	E-Ring	343L889G6	1	1	1	
		343L889G18				1
3	Drive Stud	343L889G7	1	1		
		343L889G14			1	
		343L889G19				1
4	Yoke	N/A				
5	Mtg Hardware	See Table 2	-	-	-	-
6 & 6A	Upper & Lower Yoke Toggle Plates	343L889G15	1	1		
		343L889G13			1	1
7, 8 18, 19	Mtg Hardware	See Table 2	-	-	-	-
9	Extended Drive Rod	TDSR	1	1		
		TDSR1			1	
		TDSR2 (SDOM6)				1
11	Drive Pin	343L889G10	2	2	2	
12	Washer					
13	Cotter Pin					
15	Nut	³ / ₈ -16			2	4
16	Lock Washer	3/8			2	4
17	Flange Stiffener Kit	TDSR	1*	1*	1	2

* Not supplied - order as separate, optional accessory.

These instructions do not purport to cover all details or variations in equipment nor to provide for every possible contingency to be met in connection with installation operation or maintenance. Should further information be desired or should particular problems arise which are not covered sufficiently for the purchaser's purposes, the matter should be referred to the ABB Company.

Table 2. Mounting hardware

Cat. No.	Operating Mechanism (5)		Circuit Breaker (7)		Yoke Toggle Plates (8)	
	Qty.	Type	Qty.	Type	Qty.	Type
SDOM1A	.4	1/4-20 x 7/16	4	8-32 x 2 7/8	4	3/4-20 x 7/16
SDOM3				12-24 x 3 3/4		
SDOM4				1/4-20 x 3 3/4		
SDOM6				5/16-18 x 1 1/4		