

1SDH001256R0002

L7954

Ekip GPRS-M

**Operating Instruction for
Ekip GPRS-M Module
compatible with low voltage circuit breakers by ABB SACE**



WARNING



**HAZARDOUS VOLTAGE
CAN SHOCK, BURN
OR CAUSE DEATH.**

Do not attempt to handle, install, use or service
this product before reading instruction book

PLEASE READ THIS DOCUMENT CAREFULLY BEFORE INSTALLING OR USING THIS DEVICE WITH CIRCUIT BREAKER AND RELATED PROTECTION UNIT.

- Store these instructions in conjunction with any other instructions, drawings, and descriptive documents. Keep this document available for use.
- Follow the safety procedures specified by your Company.
- Do not remove covers, open doors, or work on the equipment connected to the device, if you have not cut off the power to the switchboard, and before all the circuits are powered down.



DANGER! Before performing any operation on a circuit breaker, you must:

1. **Keep the circuit breaker in the open position, and make sure that springs are discharged (if applicable).**
2. **Disconnect power from the circuit breaker (main power and auxiliary power), and ground terminals in a visible way, both on the supply side and load side.**
3. **Disconnect the circuit breaker from the plant, removing it from the switchboard if allowed by the execution.**
4. **Secure according to the rules and laws.**



WARNING! In this document are not included description of safety standards and potential interaction with plant maintenance. It should be noted that this document contains warnings and precautions, but does not provide every possible use of the device, whether or not recommended by ABB, the possible hazardous consequences of each of these use, it may ABB investigate each of them. Anyone that put in place procedures or use equipment, whether or not recommended by ABB, must carefully ensure that neither personal safety nor that of the system will be jeopardized by the procedures or equipment choices. If you require further information or specific problems arise, report the problem to a representative of ABB.

- This document has been prepared for use by qualified staff, and is not intended as a substitute for an adequate course or of appropriate experience in safety procedures.
- Is responsibility of the Customer, Installer, or End-user, to make sure that the cautions are posted, and that all doors and the control handles are locked securely when the device is left unattended, even if only momentarily.
- All information contained in this document are based on the latest product information available at the time of printing. ABB reserves the right to make changes at any time without prior notification.

Index

1	Introduction to Ekip GPRS-M	4
	General	4
	Acronyms and definitions	4
	References	5
2	User interface	6
	Product overview	6
	Front panel	6
	LEDs meanings	7
	Fault LEDs	8
	Scan pushbutton	8
	Connectors	9
3	Installation and Connection	10
	Installation	10
	Connection	10
4	Connection Architectures	11
	Connection scenarios	11
	Devices compatibility	14
5	Alarm SMS and Email report	15
	Access control list management	15
	SMS alarm event generated by trip units	15
	SMS alarm generated by digital input	15
	Operator groups	15
	Working shift	16
	Escalation groups	16
	Example acknowledgment	17
	Acknowledge SMS	18
	Email report	18
	Time Synchronization	18
	Heartbeat SMS	18
6	Ekip GPRS-M configuration	19
	Basic configuration by SMS messages	19
	Example of configuration SMS	22
	Advanced configuration by Ekip Connect	22
	Information page	23
	General settings page	24
	SMS settings page	25
	Email settings page	26
	Digital input settings page	26
	SMS Alarm Configuration page	27
	Configuration comparison by SMS and Ekip connect	28
7	Technical specification	29
	Electrical characteristic	29
	Mechanical characteristic	30
	Environmental condition	30
	Standard	30
8	Service and maintenance	31
	Troubleshooting	31
9	Electrical circuit diagrams	33
10	Annex	34
	Trip unit events triggering SMS alarm	34
	Default configuration	36
	Alarm SMS format	36
	Test SMS format	36
	Report email format	37
	Test email format	39

1 Introduction to Ekip GPRS-M

General

This manual contains information about the device Ekip GPRS-M, which allows, once connected to low voltage ABB circuit breaker, to provide status information, events and alarms via SMS or e-mail.

Ekip GPRS-M can interface to circuit breaker in three type of connection:

- Connection via local bus (W2): each circuit breaker equipped with local communication bus is connected to a GPRS module Ekip GPRS-M
- Connection via system bus (BUS 1): circuit breaker equipped with electronic trip units with communication function interface to a single unit Ekip GPRS-M. The protocol used is Modbus RTU and Ekip GPRS-M performs the function of GSM/GPRS gateway
- Connection via auxiliary contacts: Ekip GPRS-M acquires the status of a single circuit breaker through the auxiliary contact (status, position and trip) with which the circuit breaker can be equipped.

For more details about application scenarios and how to connect, refer to Par. 4 - Connection scenarios.

When a specific event occurs (see Par. 10 - Trip unit events triggering SMS alarm), the module immediately sends an SMS notification to a pre-configured list of recipients via a mobile phone network.

For long-term effective monitoring, Ekip GPRS-M can be enabled to send periodical report about the circuit breaker status via e-mails over GPRS network.

Alarming events, reported data, phone number groups and e-mail server/ accounts can be configured by SMS (basic configuration) or by the software Ekip Connect (advanced configuration). See Par. 6 for further detail.

Acronyms and definitions

NTP	Network time protocol
APN	Access point name
SMS	Short messaging service
CB	Circuit Breaker
TU	Trip Unit (Protection unit)
UTC	Coordinated Universal Time
DI	Digital Input
S/N	Serial number
SW	Software
BUS1/W2	Communication Bus
Ekip T&P	Test & Programming device for trip unit
Ekip Connect	Configuration software for trip unit

References

For information about the trip units that can be applicable to Ekip GPRS-M, the following documents must be consulted:

- [1] ABB SACE Low voltage moulded-case circuit-breakers SACE Isomax S technical catalogue
- [2] ABB SACE Low voltage moulded-case circuit-breakers up to 1600A SACE Tmax T technical catalogue
- [3] ABB SACE Low voltage moulded-case circuit-breakers up to 250 A SACE Tmax XT technical catalogue
- [4] ABB SACE Low voltage air circuit-breakers SACE Emax technical catalogue
- [5] ABB SACE Low voltage air circuit-breakers SACE Emax X1 technical catalogue
- [6] ABB SACE Low voltage air circuit-breakers SACE Emax 2 technical catalogue
- [7] ABB SACE Low voltage air circuit-breakers SACE HF technical catalogue
- [8] ABB SACE Ekip Connect User Manual

2 User interface

Product overview

Below are shown the different parts composing the Ekip GPRS-M device.

Description		Picture
Pos.	Description	
1	Front panel	
2	X3 Digital input connector (I1, I2)	
3	X4 Digital input connector (I3, I4)	
4	X1 Power supply connector	
5	X2 BUS connector (BUS1/W2)	
6	Antenna SMA connector	
7	Din Rail PE contact	
8	GSM/GPRS Antenna	

Front panel

Below is shown the description of the front label.

Description			Picture
Pos.	Description	Note	
1	Power LED	Green	
2	Device Fault LED	Red	
3	MOD BUS Tx LED	Yellow	
4	MOD BUS Fault LED	Red	
5	GPRS Status LED	Yellow	
6	GPRS Fault LED	Red	
7	Digital input status LEDs	Yellow	
8	Scan pushbutton BUS (BUS1/W2)		
9	SIM Card Holder Slot	Push-Push Style	
10	Ekip T&P configuration port		

LEDs meanings

Below is shown the meaning of the LEDs of the front label.

Function	LED	Status	Description
Service	Power LED	ON	Auxiliary supply present and in the correct range
		OFF	Auxiliary supply absent or in the wrong range
	FAULT	ON/Blink	Device not working or not properly configured
		OFF	No malfunction is currently present
Communication BUS (BUS1/W2)	Tx	ON	Transferring data on BUS
		OFF	No transmission on BUS
	Fault	ON/Blink	BUS communication not working or not properly configured
		OFF	No malfunction is currently present
GPRS	Status	3 blinks every 1s	Transmission of GSM/GPRS data
		1 blink every 3s	Ekip GPRS-M connected to the GSM/GPRS network
		1 blink every 1s	Ekip GPRS-M searching for GSM/GPRS network
	Fault	ON/Blink	GSM/GPRS section not working or not properly configured
		OFF	No malfunction is currently present
Input	Digital input status LEDs	ON	Contact on digital inputs is close
		OFF	Contact on digital inputs is open

Fault LEDs

Below is shown the meaning of the fault LEDs blinking pattern.

Function	Blinking pattern	Description
Device Fault LED	Fixed ON	Internal malfunction
	One blink followed by 1 sec pause	RTC Malfunction (see Par. 5 – time synchronization)
	Two blinks followed by 1 sec pause	Internal malfunction power supply
	Three blinks followed by 1 sec pause	Invalid date
BUS Fault LED	Fixed ON	Ekip GPRS-M Modbus communication not configured
	One blink followed by 1 sec pause	No device detected after scan of the bus
	Two blinks followed by 1 sec pause	At least one of the detected device is not compatible with Ekip GPRS-M
	Three blinks followed by 1 sec pause	At least one detected device has become unavailable
GPRS Fault LED	Fixed ON	SIM Card not present
	One blink followed by 1 sec pause	SIM Card Locked
	Two blinks followed by 1 sec pause	Internal malfunction of GSM/GPRS section
	Three blinks followed by 1 sec pause	Network operator not registered
	Four blinks followed by 1 sec pause	GSM/GPRS signal strength too weak

Scan pushbutton

Press the scan pushbutton to scan the bus and detect the protection units connected or to perform a factory reset of Ekip GPRS-M device.

- **Push the button at least 1s and less than 5s** to performs the scan of BUS and detect compatible connected protection units
- **Push the button for more than 5s** to reset the device to factory default configuration

 **NOTE:** after adding, removing or changing the communication parameter of any protection units connected to Ekip GPRS-M, you need to perform a new scan in order to update the device to the new system configuration.

 **WARNING!** The device reset delete all phone numbers, email addresses and configuration parameters previously set up.

Connectors

Below the description of Ekip GPRS-M connectors.

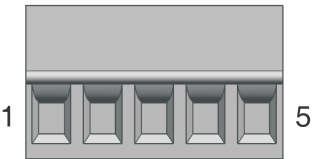
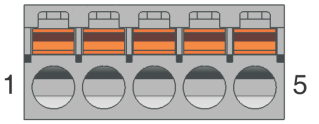
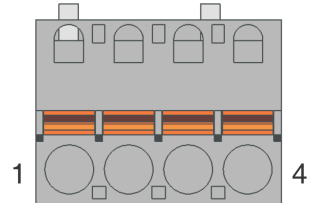
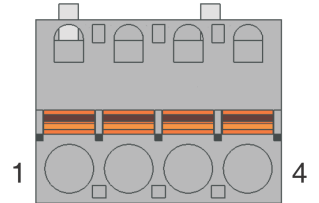
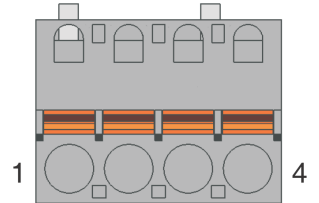
Connector name	Description			Picture
X1 24VDC AUXILIARY SUPPLY	Pin	Label	Description	
	1	K1	DIRECT 24VDC AUXILIARY SUPPLY +	
	2	K2	DIRECT 24VDC AUXILIARY SUPPLY -	
	3	PE	Protection earth	
	4	-		
	5	-		
X2 BUS1 / W2	Pin	Label	Description	
	1	w1	Bus 1 / W2 A	
	2	w2	Bus 1 / W2 B	
	3	PE	Protection earth	
	4	-		
	5	-		
X3 Digital input 1 and 2	Pin	Label	Description	
	1	I2	Digital Input 2	
	2	I2c	Digital Input 2 common	
	3	I1	Digital Input 1	
X4 Digital input 3 and 4	Pin	Label	Description	
	1	I4	Digital Input 4	
	2	I4c	Digital Input 4 common	
	3	I3	Digital Input 3	
X4 Digital input 3 and 4	Pin	Label	Description	
	4	I3c	Digital Input 4 common	

3 Installation and Connection

Installation

Below is shown how to mount Ekip GPRS-M device on standard 35 mm guide (DIN EN50022 type TS 35 x 15 mm).

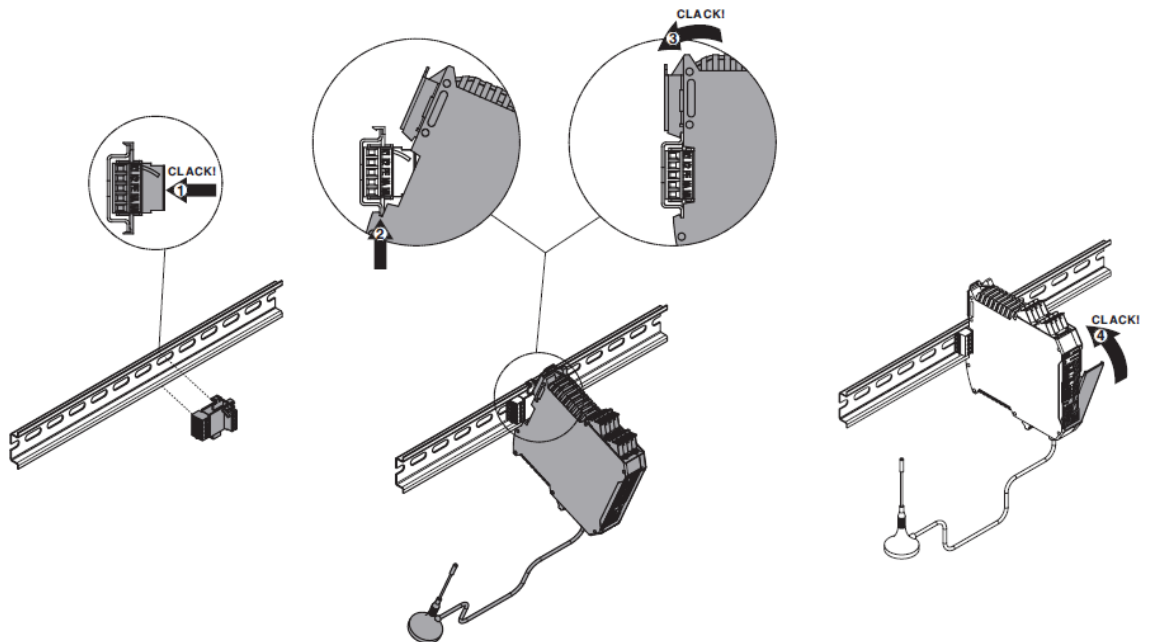

Connect the antenna cable to the SMA antenna connector and make sure that the place where the Ekip GPRS-M is installed is covered by GSM signal. Insert the SIM card in the corresponding slot.

i **NOTE:** The PIN code of the SIM card should be disabled before it is installed into Ekip GPRS-M. A simple way to do this is using a mobile phone, please refer to the User's Manual of the mobile phone of how it is done. For information on how to disable the PIN code for multiple SIM cards please contact your network operator.

! **WARNING!** Make sure that all the important messages stored in the SIM card have been backed up before inserting the SIM card. After being powered on, Ekip GPRS-M will check available free space SIM card for SMS, if free space is not enough it will permanently delete all data in it.

Connection

Carefully consider the relevant electrical diagram in Par. 9 for the correct wiring of each terminal.

For the dedicated inputs and outputs, wiring different than that described in the electrical diagram section is not allowed.

4 Connection Architectures

Connection scenarios

ABB low voltage circuit breaker voltage can be connected to the module Ekip GPRS-M in three different ways depending on the version of the circuit breaker and electronic protection unit.

- Connection via a local bus (W2): each Ekip GPRS-M device is connected to a circuit breaker via local bus W2. This connection is valid for circuit breakers equipped with electronic trip units provided with local bus and does not require the presence of a communication network.
For the proper functioning of the local bus of the protection unit required galvanically isolated 24 Vdc power supply (refer to the instruction manual of each electronic protection units). After connecting the module to TU it is necessary to proceed to the recognition of the same by pressing the SCAN button (see Par. 2 - Scan pushbutton). Refer to Figure 1.
- Connection via system bus (BUS 1): Ekip GPRS-M is connected to circuit breaker equipped with electronic protection units (provided with optional Modbus RTU communication module) via Modbus RTU communications network. For the proper functioning of the communication bus, a 24 Vdc power supply with galvanic insulation is required (refer to the instruction manual of each electronic protection unit). In this case Ekip GPRS-M acts as master of communication network; trip units connected to the network must have the same communication parameters (baud rate, parity, physical protocol) and different Modbus serial address. To configure the communication parameters of protection units refer to the instructions manual. It is possible to connect up to 15 circuit breakers to a single Ekip GPRS-M on the same communication network. Pressing the SCAN button (see Par. 2 - Scan pushbutton), Ekip GPRS-M will automatically search for devices connected to the network and immediately starts monitoring. Refer to Figure 2.
- Connection via hard-wired digital inputs: each Ekip GPRS-M device is connected to a circuit breaker via the auxiliary contacts of state and location with which the circuit breaker can be equipped. In this case the device acquires information relating to the status and position of the switch and is able to notify a change. In this way it can be connected also with thermomagnetic circuit breaker or switch-disconnectors. Refer to Figure 3.

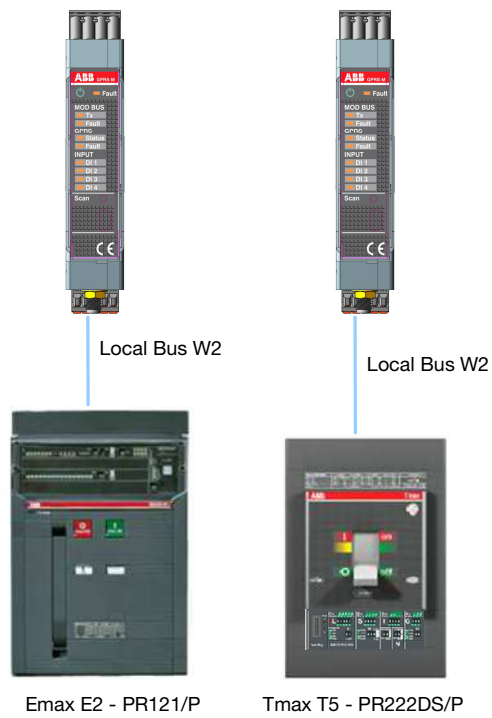

Figure 1

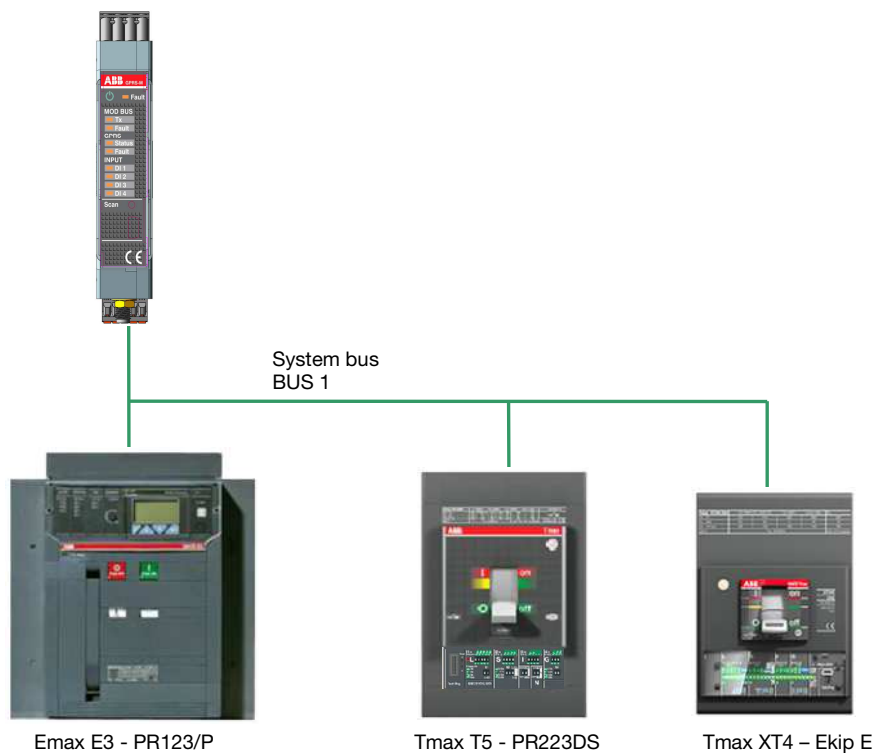
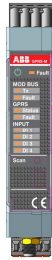

Figure 2

Emax MS



Digital input



Tmax T5 TM



Digital input



Figure 3

**Devices
compatibility**

The following table shows the compatibility for different type of circuit breaker:

<i>Circuit breaker</i>	<i>Trip unit</i>	Types of connection		
		SYSTEM BUS (BUS 1)	LOCAL BUS (W2)	HARD-WIRED (DIGITAL INPUTS)
Emax Emax X1 Tmax T7 T8	PR112/PD	√	√	√
	PR113/PD	√	√	√
	PR112/P PR113/P	-	√	√
	PR121/P	-	√	√
	PR122/P PR123/P	√ (+ PR120/D-M)	√	√
	PR331/P	-	√	√
	PR332/P- PR333/P	√ (+PR330/D-M)	√	√
	PR122/DC PR123/DC	√ (+ PR120/D-M)	√	√
	PR122/VF	√ (+ PR120/D-M)	√	√
	Tmax	PR222DS/PD	√	√
PR222DS/PD-A		√	√	√
PR223DS		√	√	√
PR223EF		√	√	√
Tmax XT	Ekip E-LSIG	√ (+Ekip Com)	-	√
	Ekip LSI	√ (+Ekip Com)	-	√
	Ekip LSI	√ (+Ekip Com)	-	√
	Ekip M-LRIU	√ (+Ekip Com)	-	√
HF	PR121/P-HF PR122/P-HF	-	√	√
	PR331/P-HF PR332/P-HF	-	√	√
	Isomax	PR212/P	√ (+PR212/D-M)	-
Emax 2	Ekip DIP	√ (+Ekip COM Modbus RS485)	-	√
	Ekip LCD	√ (+Ekip COM Modbus RS485)	-	√
	Ekip Touch	√ (+Ekip COM Modbus RS485)	-	√

5 Alarm SMS and Email report

Access control list management To provide for maximum security and prevent unauthorized access of Ekip GPRS-M, the device contains an access control list of phone numbers that can access the device. This list holds the valid telephone numbers that is authorized to access the device. Maximum 5 data call numbers can be stored in the access control list. If no phone numbers are stored in the access control list the device will accept configuration commands from any phone number.

 **NOTE:** The access control list will be erased upon a factory reset.

SMS alarm event generated by trip units Ekip GPRS-M can be configured to send SMS alarm when a specified event occurs on the plant and it's detected by one of the connected trip unit. Each compatible trip units has a list of events that can generate SMS alarm.

SMS alarm generated by digital input Ekip GPRS-M can be configured to send SMS alarm when a specified event occurs on any of the four digital inputs. A "back to normal" SMS can be configured to be sent. Each DI can be configured to send SMS on event as shown in the following table. A custom TAG Name string can be defined for each DI.

DI Alarm condition	Event generating Alarm SMS	Event generating Back to normal SMS
Close	DI transition: Open->Close	DI transition: Close->Open
Open	DI transition: Close->Open	DI transition: Open->Close

Each DI is associated with a custom description (Name TAG).

By default it is proposed the term DI 1, ... DI 4; through the SW Ekip Connect you can customize the description for a more immediate identification of the meaning of the digital input.

Operator groups The recipients of the alarm text messages can be grouped into three Operator groups called A, B and C. Each operator group can be assigned with different work shifts. Up to 5 phone numbers can be assigned to each operating unit. The SMS alert is sent to the group whose work shift coincide with the time at which the event occurred. It can be possible to configure Ekip GPRS-M to acknowledge the alarm message by sending a dedicated SMS by any of the telephone numbers in the operator groups. If the event is not acknowledged by any operator, the SMS is sent continuously at regular intervals of time (repetition time). The maximum number of repetitions can be configured. If the event is acknowledged, the alarm SMS stop to be sent.

Working shift

It is possible to assign up to 8 different arrangement of working shifts, in each arrangement working hours are 8 to cover the entire 24-hour period with three groups.

It's available also a special combination (No. 9) in which all the operator groups are available 24 hours a day

Working shift selection	GROUP A availability time for receiving SMS	GROUP B availability time for receiving SMS	GROUP C availability time for receiving SMS
1	00:00 ... 08:00	08:00 ... 16:00	16:00 ... 00:00
2	01.00 ... 09.00	09:00 ... 17:00	17:00 ... 01:00
3	02.00 ... 10.00	10:00 ... 18:00	18:00 ... 02:00
4	03.00 ... 11.00	11:00 ... 19:00	19:00 ... 03:00
5	04.00 ... 12.00	12:00 ... 20:00	20:00 ... 04:00
6	05.00 ... 13.00	13:00 ... 21:00	21:00 ... 05:00
7	06.00 ... 14.00	14:00 ... 22:00	22:00 ... 06:00
8	07.00 ... 15.00	15:00 ... 23:00	23:00 ... 07:00
9	00:00 ... 24:00	00:00 ... 24:00	00:00 ... 24:00

If, e.g., the working shift number 7 is configured, that means that phone numbers in Group A will receive all SMS alarm events happening from 6am to 2pm, Group B will receive all SMS alarm events happening from 2pm to 10pm and Group C will receive all SMS alarm events happened from 10pm to 6am.

Escalation groups

Ekip GPRS-M provides the possibility to configure two escalation groups (A, B). Up to 5 phone numbers can be assigned to each group.

If the event is not acknowledged by any of the operators after a defined acknowledge time before escalation, an information SMS will be sent to escalation group A. The defined acknowledge time before escalation starts from the time the 1st alarm SMS alarm is sent to operator groups. If the event is still not acknowledged after the defined acknowledge time before escalation (configurable), an information SMS will be sent to escalation user group B.

The acknowledge time before escalation starts from the time the information SMS to escalation group A is sent.



NOTE: Only one information SMS will be sent to escalation groups.



NOTE: Escalation groups can also acknowledge the alarm event.

**Example
acknowledge-
ment**

The following example shows the temporal evolution of the sending of alarm and escalation SMS in the event in which the alarm is not acknowledge.

The alarm trigger time is at 8:00AM.

Working shift selected: n° 3

SMS number of retry (after the first to operator groups): 4

SMS time between retry (to operator groups): 10 minutes

Acknowledge time before escalation: 15 minutes

<i>Time</i>	<i>Operators (Group A)</i>	<i>Escalation group A</i>	<i>Escalation group B</i>
8:00 AM	1 st Alarm SMS received		
8:10 AM	2 nd Alarm SMS received		
8:15 AM		Escalation SMS received	
8:20 AM	3 rd Alarm SMS received		
8:30 AM	4 th Alarm SMS received		Escalation SMS received
8:40 AM	5 th Alarm SMS received		
Stop	NO MORE SMS ARE SENT. The maximum number of retry is reached with no acknowledge received.		

The following example shows the temporal evolution of the sending of SMS in case in which the alarm is acknowledge by an operator of the escalation group A.

<i>Time</i>	<i>Operators (Group A)</i>	<i>Escalation group A</i>	<i>Escalation group B</i>
8:00 AM	1 st Alarm SMS received.		
8:10 AM	2 nd Alarm SMS received		
8:15 AM		Escalation SMS received Acknowledge SMS is sent	
Stop	NO MORE SMS ARE SENT. The alarm is acknowledged.		

Acknowledge SMS

Acknowledge can be executed by sending a SMS to Ekip GPRS-M from any one of the phone numbers stored in Operator or Escalation groups.

The SMS format for acknowledgement can be one of the following:

Connection architecture	Format	Description
LOCAL BUS (W2)	ACK	Acknowledge all the pending alarm generated by trip units
SYSTEM BUS (BUS 1)	ACK : 123	Acknowledge all the pending alarm generated only by the trip unit with Modbus address equal to 123  NOTE: Valid addresses are [1...247]
DIGITAL INPUT	ACK : DI	Acknowledge all the pending alarm generated by digital input

Email report

If you are using the connection via BUS (BUS 1/W2), Ekip GPRS-M can send reports via email about the status of the protection units connected to it.

The reports can be sent:

- Periodically: The time for delivery of reports can be configured to occur at fixed intervals of n days (n configurable from 1 to 365)
- On demand: The user can force the sending of reports via email by sending an SMS command as described in Par. 6.

The user can configure up to 5 email addresses as recipients. In order to use GPRS communication you must also configure some parameters, such as the APN and the SMTP server.

To know the value of SMTP and APN parameter, contact your network operator and email provider.

Time Synchronization

Time synchronization allows the unit to synchronize its internal clock with the local time. This is useful to know the exact time when the alarm event occurs. Ekip GPRS-M device can be synchronized using NTP server or using the PC time.

Time Synchronize with NTP server

Ekip GPRS-M can be configured to synchronize automatically via NTP setting up to 3 different NTP server addresses. Because NTP synchronization refer to UTC time, time zone must also be set.

A list of NTP server address can be found on the internet.

Time Synchronize with PC

Ekip GPRS-M can synchronize the time with PC by advanced configuration using Ekip connect.

 **NOTA:** RTC (real-time clock) is integrated in the device and can keep up to date time and date up to 12 hours without auxiliary power supply.

Heartbeat SMS

Ekip GPRS-M can be configured in order to send a SMS daily containing information about the internal status of the device (heartbeat SMS).

6 Ekip GPRS-M configuration

Basic configuration by SMS messages

The SMS message format for Ekip GPRS-M consists of a command data field and optional parameter field separated by the “:” character.

COMMAND	:	PARAM. 1	:	PARAM. 2	:	PARAM. 3	:	PARAM. 4	:	PARAM. 5
---------	---	----------	---	----------	---	----------	---	----------	---	----------

The command field consists of codes of a various numbers of commands.

The number of parameters can range from 0 to 5 depending of the given command type.

Parameter content can be numbers (e.g. phone numbers) or strings (e.g. email addresses)

 **NOTE:** The total length of the SMS cannot exceed 140 characters.



 **NOTE:** All commands should be put in the same line and they are case sensitive.





 **NOTE:** All parameters are necessary except for command related to the setting of phone numbers and email addresses.

 **NOTE:** Phone number must have international area code starting with “+” (e.g. +86 for China, +39 for Italy).

 **NOTE:** If one SMS message for configuration is received by Ekip GPRS-M, then decoded and executed successfully, the GPRS Fault LED will fast blink (blink 4 times) for one second; otherwise, If the SMS message for configuration is received but not executed (because of no valid instruction, parameter error or no authority), the GPRS Fault LED will keep lit on for two seconds

Below is shown the complete list of configuration SMS commands and parameters.

Command	Parameters	Function
ADMIN	Parameter 1 = [Phone number] Parameter 2 = [Phone number] Parameter 3 = [Phone number] Parameter 4 = [Phone number] Parameter 5 = [Phone number]	Setting phone numbers for access control list.  NOTE: if no parameter is set the entire list will be cleared.
SMTP	Parameter 1: [SMTP address] Parameter 2: [SMTP port] Parameter 3: [Username for auth] Parameter 4: [Password for auth] Parameter 5: [Email address]	Setting SMTP server information to enable the sending of trip unit email reports.  NOTE: All parameters must be provided.
APN	Parameter 1: [Access point name]	Setting The Access Point Name.
USEREA	Parameter 1: [Email address] Parameter 2: [Email address] Parameter 3: [Email address] Parameter 4: [Email address] Parameter 5: [Email address]	Setting User email address recipient list for email report.  NOTE: if no parameter is set the entire list will be cleared.
EMAILSCH	Parameter 1: [0 1...365]	Set the time interval (in days) for the periodic email reports. If you want to disable the function set 0 as parameter.

NTP	Parameter 1: [server address] Parameter 2: [server address] Parameter 3: [server address] Parameter 4: [-12...+11] Parameter 5: [Y N]	Set the NTP configuration for time synchronization. Parameter 1...3: NTP server address. Parameter 4: setting the time zone (Step: 1 hour). Parameter 5: enable time synchronization if set to Y.
TESTSMS	Parameter 1: [Phone number]	Trigger Ekip GPRS-M to send a test SMS to the phone number specified in parameter.
TESTEMAIL	Parameter 1: [Email address]	Trigger Ekip GPRS-M to send a send a test email to the address specified in parameter.
USERPNA	Parameter 1: [Phone number] Parameter 2: [Phone number] Parameter 3: [Phone number] Parameter 4: [Phone number] Parameter 5: [Phone number]	Setting phone numbers for operator group A.  NOTE: if no parameter are set all the list will be cleared.
USERPNB	Parameter 1: [Phone number] Parameter 2: [Phone number] Parameter 3: [Phone number] Parameter 4: [Phone number] Parameter 5: [Phone number]	Setting phone numbers for operator group B.  NOTE: if no parameter is set the entire list will be cleared.
USERPNC	Parameter 1: [Phone number] Parameter 2: [Phone number] Parameter 3: [Phone number] Parameter 4: [Phone number] Parameter 5: [Phone number]	Setting phone numbers for operator group C.  NOTE: if no parameter is set the entire list will be cleared.
ESCPNA	Parameter 1: [Phone number] Parameter 2: [Phone number] Parameter 3: [Phone number] Parameter 4: [Phone number] Parameter 5: [Phone number]	Setting phone numbers for escalation group A.  NOTE: if no parameter is set the entire list will be cleared.
ESCPNB	Parameter 1: [Phone number] Parameter 2: [Phone number] Parameter 3: [Phone number] Parameter 4: [Phone number] Parameter 5: [Phone number]	Setting phone numbers for escalation group B.  NOTE: if no parameter is set the entire list will be cleared.
TIMTURN	Parameter 1 = [0...8]	Working shift selection for operator groups A, B and C. 0: A=[00..08] B=[08..16] C=[16..24] 1: A=[01..09] B=[09..17] C=[17..01] 2: A=[02..10] B=[10..18] C=[18..02] 3: A=[03..11] B=[11..19] C=[19..03] 4: A=[04..12] B=[12..20] C=[20..04] 5: A=[05..13] B=[13..21] C=[21..05] 6: A=[06..14] B=[14..22] C=[22..06] 7: A=[07..15] B=[15..23] C=[23..07] 8: A=[00..24] B=[00..24] C=[00..24]
ACTR	Parameter 1 = [Y N]	Acknowledgement configuration. Y: enable event acknowledgement N: disable event acknowledgement

SMSDITR	Parameter 1 = [O2C C2O N] Parameter 2 = [O2C C2O N] Parameter 3 = [O2C C2O N] Parameter 4 = [O2C C2O N]	DI event configuration. Parameter n: O2C enable SMS Alarm on open to close of DI number n. C2O enable SMS Alarm on close to open of DI number n. N disable SMS Alarm notification of DI number n.
SMSTUTR	Parameter 1: [0 1] Parameter 2: [0 1] Parameter 3: [0 1] Parameter 4: [0...247]	SMS event configuration for single TU. Parameter 1: Enable the sending of SMS on any trip event if set to 1 Parameter 2: Enable the sending of SMS on any alarm event if set to 1 Parameter 3: Enable the sending of SMS on any change in status event if set to 1 Parameter 4: Modbus address of the trip unit related to SMS configuration. If you want to set the same configuration for all trip units just use 0 as Modbus address . See Par. 10 - Trip unit events triggering SMS alarm.
LANG	Parameter 1: [1 2 3 4 5 6]	Set the language of alarm SMS and email report. 1: English 2: Italian 3: German 4: French 5: Spanish 6: Chinese
EMAILREP	Parameter 1: [0...247]	Trigger Ekip GPRS-M to send email report of trip unit which address is specified by parameter to recipient(s) if parameter differs from 0, of all protection units if parameter equal 0.

Example of configuration SMS

Below is shown some example of configuration SMS

```
ADMIN:+86132456:+86123456:+86123456:+86123456:+86123456
```

Set five phone numbers for access control list

```
TESTSMS:+86123456
```

Command to send out a test SMS to the indicated phone number

```
USERPNB:+86123456:+86123457
```

Set two operator phone numbers for Group B. If already present the third, the fourth and the fifth will be deleted

```
USERPNC:+86123456::+86123457
```

Set the first and the third operator phone number in Group C. If already present, the second, the fourth and the fifth will be deleted

```
NTP:clock.xxx.com:::-2:Y
```

Configure NTP server address (only the first of the three available), set Time Zone as -2 and enable time synchronize function.



NOTE: In the case you want to leave empty some parameters or in case you want to delete some data previously written, you can simply send the command only followed by separator characters ":". There is no need to enter space character between two consecutive separators.

Advanced configuration by Ekip Connect

The configuration of Ekip GPRS-M can also be done with the software Ekip Connect for personal computers. It requires the presence of accessory Ekip T&P for the connection of the personal computer to the configuration port of Ekip GPRS-M positioned on the front panel.

Make sure all the trip units are connected and correctly communicating with Ekip GPRS-M before starting configuration with Ekip Connect. Configuration can be done without 24V auxiliary power module, as the Ekip T&P is able to power Ekip GPRS-M via the PC USB port.



NOTE: When the module is powered only through the Ekip T&P, the network function (sending SMS messages and e-mails) will be disabled.



NOTE: ASCII character fields in the following description (e.g. TAG Name of Ekip GPRS-M, TU and DI) will be used in composing the SMS alarm. For coding restriction we suggest to use only the following characters:**[0...9] [A...Z] [a...z] [space] ! " # % & ' () * + , - . / : ; < = > ?**

Other characters may not be supported by SMS coding.



WARNING! For software configuration it is necessary to use only the cables supplied with the Ekip T&P module. Do not use cables other than those supplied.

Information page

The screenshot shows the 'Information' page in the ABB Ekip Connect software. The left sidebar contains a tree view with options like 'Information', 'Alarms', 'Settings', 'General Settings', 'SMS Settings', 'Email Settings', 'DI Settings', 'SMS Alarm Configuration', 'SMS History', and 'Email Report History'. The main content area is titled 'Information' and is divided into several sections:

- GENERAL PARAMETERS:** SW version (01.12), Device S/N, Product execution (Ekip GPRS-M).
- TIME STAMP:** Validity (VALID), Date (30.07.2013), Time (11:44:39).
- DATES (SETTING):** Timestamp (30.07.2013 11:43:36), Date of installation (31.12.1999).
- STATUS:** SIM Card (PRESENT), Network Registration (REGISTERED, HOME NETWORK), GPRS Status (NOT CONNECTED), PIN CODE (OK), SMS Transmitting (Not transmitting), Email Transmitting (Not transmitting), System Bus Scanning (NO), Device Configured (YES), GPRS Section Power ON (Power ON).
- DI STATUS:** DI1 (OPEN), DI2 (OPEN), DI3 (OPEN), DI4 (OPEN).
- WINK STATUS:** Wink Status (NOT ACTIVE).
- CUSTOM FIELDS:** TAG Name (EkipGPRS-M), User data (QUALITY OK).

At the bottom, there are buttons for 'COMMANDS TEST', 'Self Test', 'Communication', 'Wink On', 'Wink Off', 'Submit', and 'Reset'.

In this pages user can set:

- time and date of Ekip GPRS-M with the PC time and date (only if NTP synchronization is disabled)
- installation date
- Ekip GPRS-M TAG Name and User Data (Up to 10 ASCII characters)

 **NOTE:** RTC (real-time clock) is integrated into Ekip GPRS-M and retain valid timestamp for 12 hours without external power supply.

General settings page

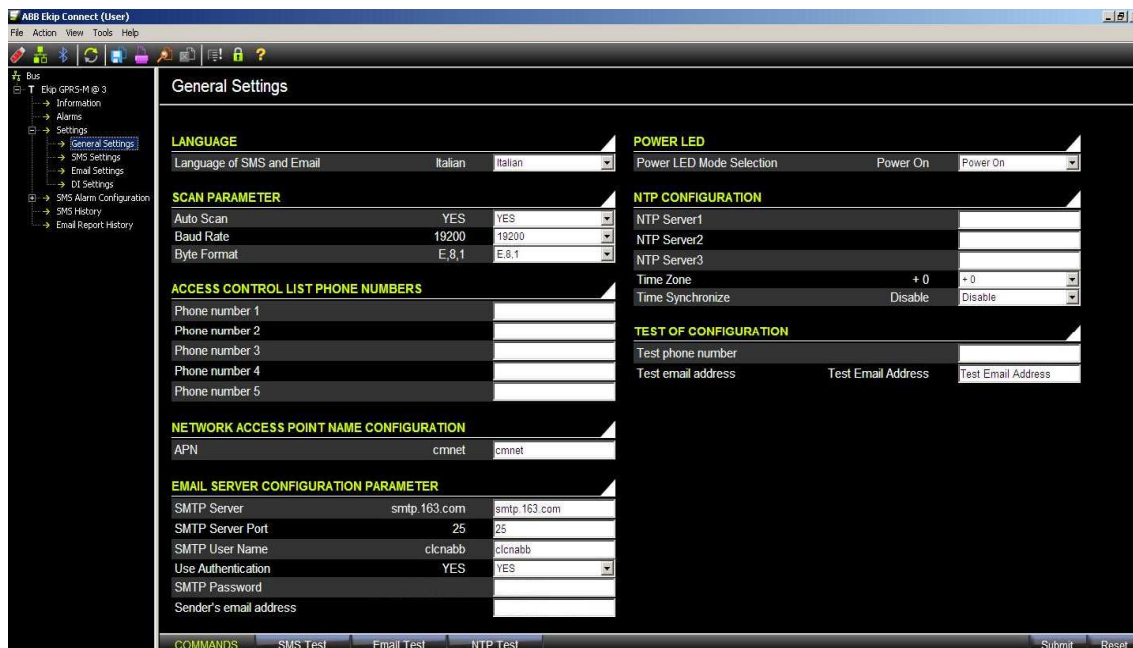

In this page user can set:

- Ekip GPRS-M language (alarm SMS and email report)
- Access Control List phone numbers
- APN and SMTP parameter (email)
- NTP parameter (time synchronization)
- Test the correct configuration of Ekip GPRS-M (TEST OF CONFIGURATION section).
- the behavior of Power LED (Alive mode/Power ON mode)
- Disable the automatic scan functionality on Modbus bus. If automatic scan is disabled the user must select the communication parameter that Ekip GPRS-M will use to identified devices connected on the bus

SMS settings page

The screenshot displays the 'SMS Settings' configuration page in the ABB Ekip Connect software. The interface is organized into several sections:

- OPERATOR GROUP A:** Five input fields for 'Phone number 1' through 'Phone number 5'.
- OPERATOR GROUP B:** Five input fields for 'Phone number 1' through 'Phone number 5'.
- OPERATOR GROUP C:** Five input fields for 'Phone number 1' through 'Phone number 5'.
- TIME SHIFT FOR OPERATOR GROUP:** A 'Time Shift Selection' dropdown menu with options: A=[00..24] B=[00..24] C=[00..24] and A=[00..24] B=[00..24] C=[00..24].
- USER ACKNOWLEDGE SETTINGS:**
 - User acknowledge: NO (dropdown)
 - SMS number of retry: 1 SMS (dropdown)
 - Time between SMS retry: 8 Minute (dropdown)
 - ACK Time before Escalation: 10 Minute (dropdown)
- HEART BEAT CONFIGURATION:** Heart Beat: Disable (dropdown)
- ESCALATION GROUP A:** Five input fields for 'Phone number 1' through 'Phone number 5'.
- ESCALATION GROUP B:** Five input fields for 'Phone number 1' through 'Phone number 5'.

At the bottom right, there are 'Submit' and 'Reset' buttons.

In this page user can set:

- phone numbers for operator groups A, B, C
- phone numbers for escalation groups A, B
- working shift of operator groups
- Enable the function Acknowledge by SMS
- the number of maximum SMS retry if no acknowledge is received [1 to 4] (valid only if Acknowledge is enabled)
- Set the time between retry if no acknowledge is received [1 to 15 minutes] (valid only if Acknowledge is enabled)
- Set the time to wait before escalation if no acknowledge is received [0 to 30 minutes] (valid only if Acknowledge is enabled)
- Enable Heat beat functionality

 **NOTE:** Phone number must have international area code (e.g. +86 for China, +39 for Italy).

Email settings page

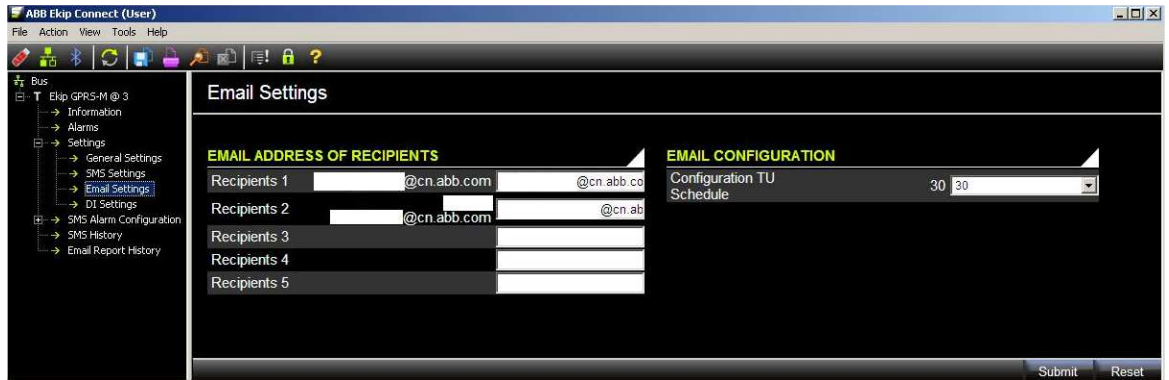

In this page user can set:

- Email addresses for reports recipients
- Email schedule for sending reports

Digital input settings page



In this page user can set:

- alarm condition for each digital input
- custom tag name for each digital input
- Enable “Back to normal” functionality (an SMS will be sent when the DI status come back to normal condition)

SMS Alarm Configuration page

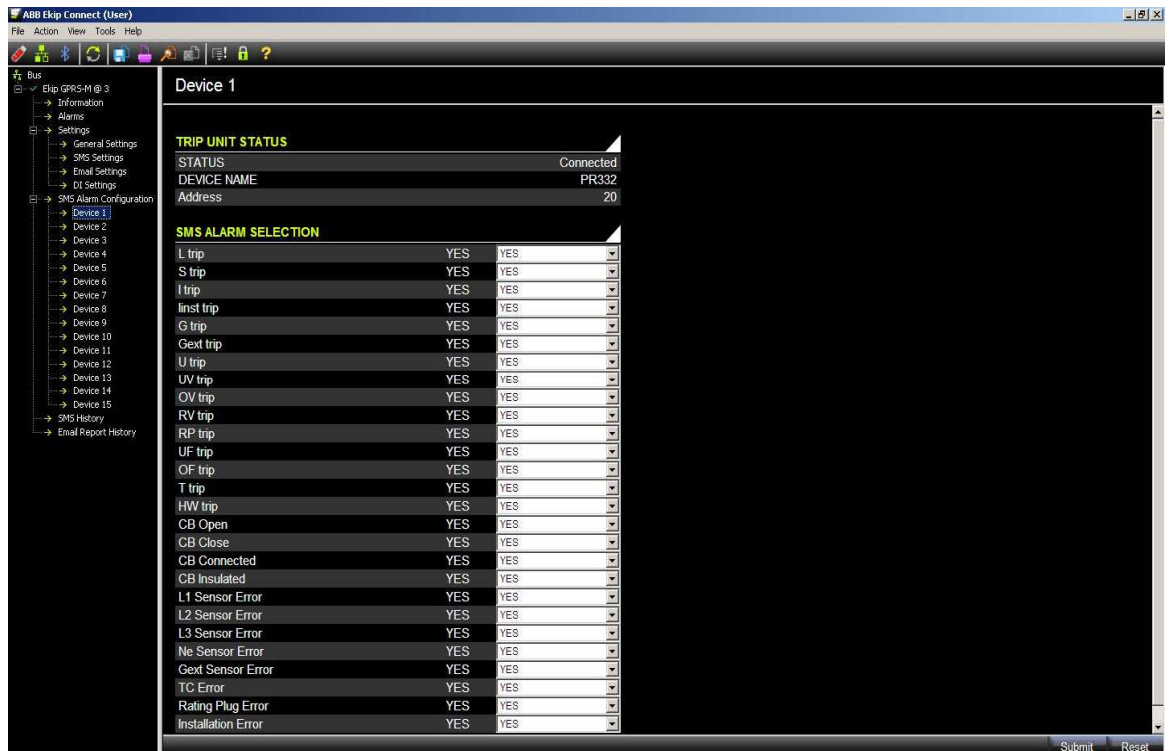

In this page user can enable/disable the event that triggers the alarm SMS for the selected TU (one page for every trip unit is provided). The page contains all the available events that can be generated by the trip unit and that can be managed by Ekip GPRS-M.

i **NOTE:** different type of TU can have different event availability (see Par. 10 - Trip unit events triggering SMS alarm)

Configuration comparison by SMS and Ekip connect

Function	SMS	Ekip connect
Set device TAG NAME		√
Set device USER DATA		√
Set the Power LED behavior		√
Set access control list phone numbers	√	√
Fixed scan parameter configuration		√
Set SMPT parameters	√	√
Set APN parameters	√	√
Set user recipient email addresses for reports	√	√
Set the scheduling of email reports	√	√
Configure NTP server parameter for time synchronization	√	√
PC time synchronization		√
Send test SMS to check configuration	√	√
Send test email to check configuration	√	√
Set operator groups phone numbers	√	√
Set the working shift for operator groups	√	√
Set the time interval for the retry of alarm SMS if no acknowledge		√
Set maximum number of retry of alarm SMS if no acknowledge		√
Set escalation groups phone numbers	√	√
Set the time interval before escalation SMS if no acknowledge		√
Enable or disable SMS acknowledge	√	√
DI configuration	√	√
Enable the back to normal SMS for DI		√
Assign to each DI a custom TAG NAME (this will be shown in the SMS)		√
Enable the groups of events (valid for all the trip units) that can generate SMS alarm	√	
Enable individually the events for trigger SMS alarm. Every TU can be configured individually		√
Set the language for SMS and email	√	√

7 Technical specification

Electrical characteristic

Radio

Characteristic	Description
GSM/GPRS	850/900/1800/1900 MHz
GPRS Mobile Station Class	B
GPRS Class	8/10

Communication protocol and compatibility

Characteristic	Description
System bus	Modbus RTU
GSM/GPRS	SMS, TCP/UDP, SMTP

24VDC auxiliary supply

Characteristic	Description
Rated voltage	24 Vdc \pm 20%
Maximum allowable ripple	\pm 5%
Rated power	6W max, 1W typical

 **WARNING!** Since the auxiliary voltage must be isolated from the ground, it is necessary to use 'galvanically separated converters', conforming to IEC standard 60950 (UL 1950) or equivalent IEC 60364-41, in order to guarantee a common mode current or a leakage current (as defined in IEC 478/1), not greater than 3.5mA

Digital Input

Digital input provide power supply (isolated from the Ekip GPRS-M power supply) to the potential free contact connected.

Characteristic	Description
Voltage	15 V
Maximum current	10 mA

Removable connectors X1, X3 and X4 can accept conductors having a cross-section between 0.5 and 1.5 mm².

Below is shown the maximum cabling distances

Connector	Maximum cabling distance (m)
System bus	250
Digital input	50

 **NOTE:** for system bus connection, the cable to be used is a shielded twisted cable. ABB recommends a cable type Belden 3105A, but it is possible to use also other cables with equivalent characteristics.

 **NOTE:** for digital input connection, the cable to be used is a twisted cable. If the device is used in harsh environment we suggest using shielded twisted cable.

 **NOTE:** for connection on local bus W2, the maximum length of the shield twisted cable must be less than 15m.

 **WARNING!** The protection earth of the Ekip GPRS-M is internally connected with the DIN rail PE contact.

**Mechanical
charatteristic**

<i>Characteristic</i>	<i>Description</i>
Housing	Polyamide
Inflammability class according to UL94	V0
Protection degree	IP41 (Front) IP20 (Housing)
Weight	180 g
Dimension	39 x 118.5 x 114mm

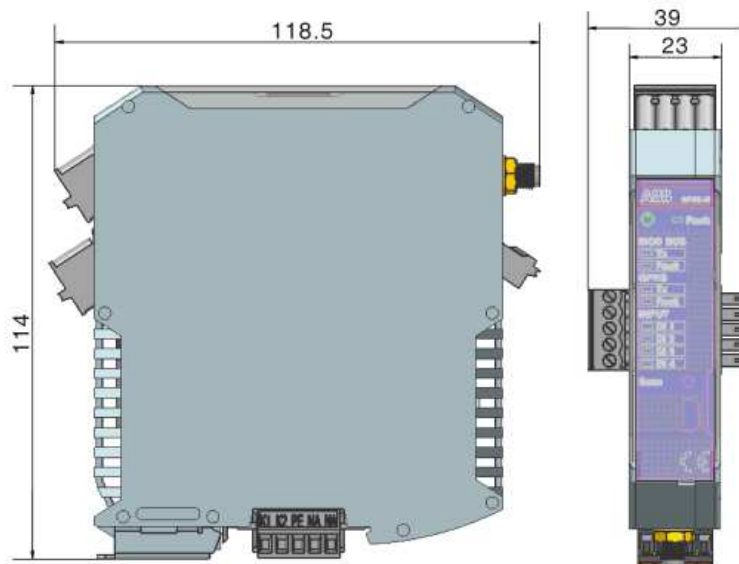

**Enviromental
condition**

<i>Characteristic</i>	<i>Description</i>
Operating temperature	-25°C ... +70°C
Storage temperature	-40°C ... +90°C
Relative humidity	5% ... 98% with condensation
Altitude	0m ... 2000m

Standard

Ekip GPRS-M is designed according to the following international standard:
IEC 60947-2

8 Service and maintenance

Troubleshooting

The next table sums up some of the common fault/malfunction situations involving Ekip GPRS-M with the aim to:

- check and isolate the cause of the fault/malfunction condition
- define a series of operative solution



NOTE: Before reading the troubleshooting table, check that Ekip GPRS-M do not shows any damage. Carefully consider the Fault LEDs behavior, as described in Par. 2 – Fault LEDs (wait that Ekip GPRS-M turn-on phase is completed before considering the Fault LEDs).

Issue	Assumed reason	Suggestion
POWER LED doesn't turn on	Auxiliary voltage not present or not properly connected	<ul style="list-style-type: none"> • Check that the auxiliary supply is present and properly connected, according to the instructions provided in Par. 9 • Check that the auxiliary voltage value is in the permitted range
Test SMS and Test email cannot be sent	<ul style="list-style-type: none"> • GSM/GPRS Signal strength too weak • Antenna is not connected • SIM Card Locked • Ekip GPRS-M APN and/or SMPT parameter non configured • The phone number configured does not include international area code 	<ul style="list-style-type: none"> • Check the GSM/GPRS signal coverage where Ekip GPRS-M is installed, if necessary replace the supplied antenna with an external antenna • Check the antenna connection • Disable PIN code of SIM card • Check the configuration of Ekip GPRS-M
Invalid date	<ul style="list-style-type: none"> • First installation or Ekip GPRS-M power off for more than 12 hours • NTP server is not available 	<ul style="list-style-type: none"> • Configure NTP server or synchronize with PC • Check NTP configuration parameter or add more than one NTP server address
No trip units found after a scan of the system bus	Address or communication parameter conflict	Check the setting of trip units to verify that all the communication parameters are the correct and that there is no address conflict and start a new configuration.

Signaling of: <ul style="list-style-type: none"> • Internal malfunction • RTC malfunction • Internal malfunction power supply • Internal malfunction of GSM/GPRS section 	Device internal malfunction	Contact ABB SACE
Operator not registered	Out of credit, Connection error to GSM/GPRS network	Contact your network operator

If the previous list does not help to solve the problem and/or if you suspect that any device is faulty, malfunctioning or has generated unexpected behavior, we recommend you to follow the instructions below:

- Write a brief description of the encountered problem by specifying the operative condition, how many times has happened and if the event is reproducible
- Write down the serial number of the unit
- Send all the information gathered, together with your application circuit diagram, to the nearest ABB technical support.

9 Electrical circuit diagrams

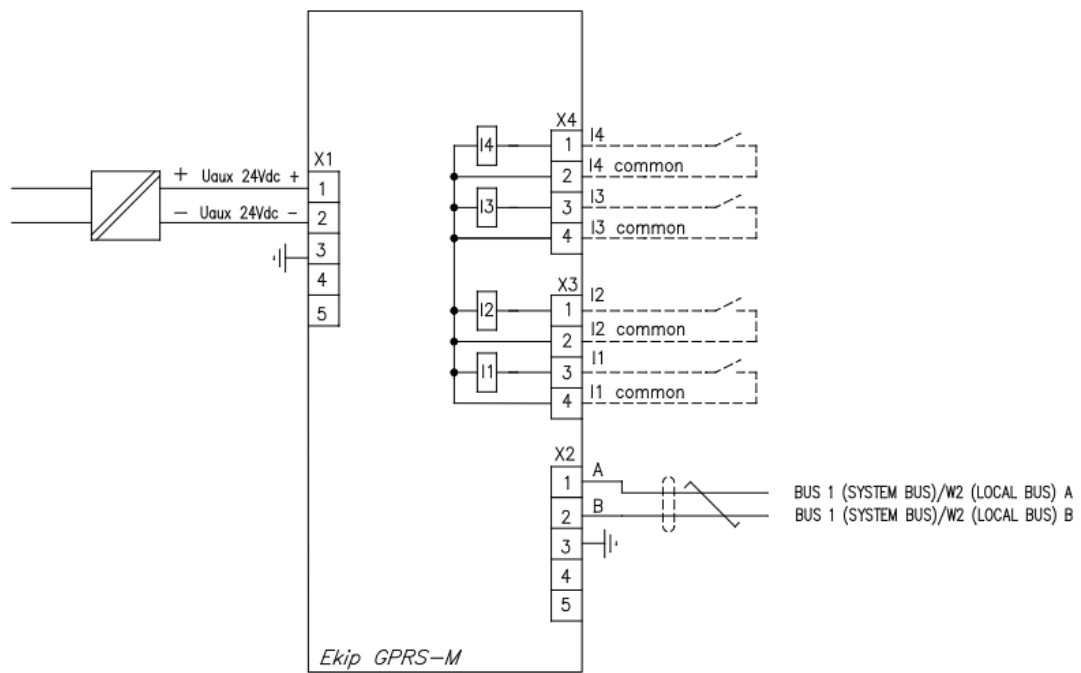

10 Annex

Trip unit events triggering SMS alarm

<i>Trip events group</i>	<i>Alarm event group</i>	<i>Status event group</i>
L trip	Power Factor Error	CB Open
S trip	Phase Cycle Error	CB Close
S2 trip	L1 Sensor Error	CB Connected
D trip	L2 Sensor Error	CB Isolated
I trip	L3 Sensor Error	
linst trip	Ne Sensor Error	
G trip	IA Sensor Error	
Gext trip	IA2 Sensor Error	
U trip	IB Sensor Error	
UV trip	IB2 Sensor Error	
OV trip	Gext Sensor Error	
RV trip	TC Error	
RP trip	Rating Plug Error	
UF trip	Installation Error	
OF trip		
T trip		
LC trip		
EF trip		
SOS trip		
PTC trip		
UC trip		
U (phase loss) trip		
R (stall) trip		
R (jam) trip		
Hw trip		
RC trip		
IU trip		
VU trip		
OQ trip		
S(V) trip		
RQ trip		
ROCOF trip		
S2(V) trip		
UP trip		
OP trip		
UV2 trip		
OV2 trip		
UF2 trip		
OF2 trip		



NOTE: not all the events are available for all the compatible trip units. Refer to user

manual of trip unit to know which kind of events is available.

 **NOTE:** For a better selectivity in the choice of alarm SMS to be received, the user can define which groups of alarm enable for individual protection unit connected through the basic configuration. Through the SW Ekip Connect this selectivity can be further refined by enabling or disabling individual items shown in the table.

Default configuration

<i>Items</i>	<i>Default Value</i>
Language	English
Automatic scan	Enabled
Time shift for operator group	Disabled
Heart beat function	Disabled
Event Acknowledge	Disabled
SMS number of retry if no acknowledge.	1
SMS retry time if no acknowledge	8 minutes
SMS time before escalation	10 minutes
SMTP Authentication	YES
SMTP server port	25
DI 1 TAG Name	DI 1
DI 2 TAG Name	DI 2
DI 3 TAG Name	DI 3
DI 4 TAG Name	DI 4
Email schedule for reports	Every 30 Days

Alarm SMS format

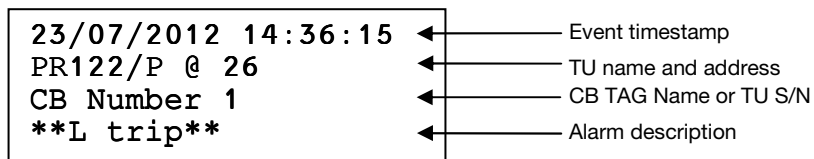

Test SMS format

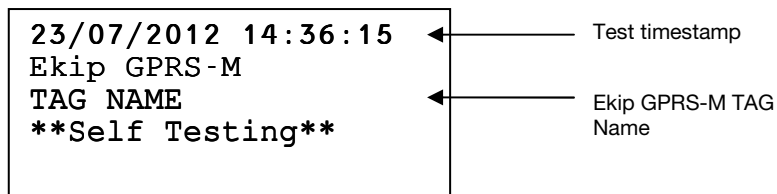

Report email format

Below is shown an example of report email. The report is sent as an attachment and it is formatted as text file.

<p>14/08/2012 17:26:19</p> <p>PR123/P @ 4 TAG NAME</p> <hr/> <p>GENERAL PARAMETER</p> <hr/> <p>Standard reference: IEC Un: 380 V In: 800 A CB serial number: XBCE015132</p> <p>Trip unit execution: LSIG Trip unit serial number: P1943X17A</p> <p>*Custom Information* CB Name: E2N1250 /3P Tag name: SACE PR12x User data: QUALITY OK</p>	<p>Ekip GPRS-M Timestamp</p> <p>Trip unit name and modbus address Ekip GPRS-M TAG Name</p> <p>General parameter of circuit breaker</p>
<hr/> <p>CB TIMESTAMP</p> <hr/> <p>14/08/2012 7:26</p>	<p>Circuit breaker timestamp</p>
<hr/> <p>STATUS</p> <hr/> <p>CB status: Closed CB Position: Isolated Spring status: Charged No Trips</p>	<p>Circuit breaker status information</p>
<hr/> <p>ALARMS</p> <hr/> <p>No Alarms</p>	<p>Circuit breaker active alarms</p>
<hr/> <p>MEASURES</p> <hr/> <p>*Currents*</p> <p>Max current (rms): ... on --- L1 Current (rms): ... L2 Current (rms): ... L3 Current (rms): ... Ne Current (rms): ---</p> <p>*Voltages*</p> <p>U12 voltage (rms): ... U23 voltage (rms): ... U31 voltage (rms): ...</p> <p>*Powers*</p> <p>Total active power: --- Total reactive power: --- Total apparent power: ---</p> <p>*Frequency*</p> <p>Frequency: ---</p> <p>*Peak Factors*</p> <p>L1 peak factor: --- L2 peak factor: --- L3 peak factor: --- Ne peak factor: ---</p> <p>*Energies*</p> <p>Total active energy: 0 kWh Total reactive energy: 0 kVARh Total apparent energy: 0 kVAh Positive active energy: 0 kWh Negative active energy: 0 kWh Positive reactive energy: 0 kVARh Negative reactive energy: 0 kVARh</p>	<p>Circuit breaker real time measure</p> <p>... means data under the minimum value --- means data not available</p>

<p>STATISTICS</p> <p>Contact wear: 1.16 % Number of protection trips and trip fails: 3 Number of total operations and trip fails: 14 Number of openings: 21 Number of protection trips: 1 Number of trip fails: 2 Number of trip tests: 9</p> <p>*****</p>	<p>Circuit breaker statistical data</p>
--	---

Server address: smtp.XXX.com Port: 25 User Name: CXXABB Password: abXXXX45 Sender's Email Address: CXXABB@XXX.com NTP SETTINGS Server address 1: www.aaa.com Server address 2: www.bbb.com Server address 3: www.ccc.com Time Zone: +8 NTP Synchronization: ENABLE REPORT EMAIL CONFIGURATION Email address 1: abc@sina.com Email address 2: abc@sina.com Email address 3: abc@sina.com Email address 4: Email address 5: Report schedule (days): 30 END OF REPORT	SMTP configuration settings NPT configuration settings Report email configuration settings
--	--



LIMITATIONS OF WARRANTIES AND LIABILITY

- There are no agreements, understandings, statements of warranty, express or implied, including warranties of merchantability or fitness for a particular purpose, outside of those specifically prescribed by an existing contract between the parties. This type of contract establishes any obligation of the seller. The content of this document will not become part of or modify any prior or existing agreement, commitment or relationship.
- The information, recommendations, descriptions and safety notations in this document are based on ABB. This information should not be considered inclusive or covering all the possible cases.



ABB S.p.A
ABB SACE Division
Via Baioni, 35
24123 Bergamo Italy

Tel.: +39 035 395.111 - Telefax: +39 035 395.306-433