

Thermal overload relay TF140DU and TF140DU-V1000

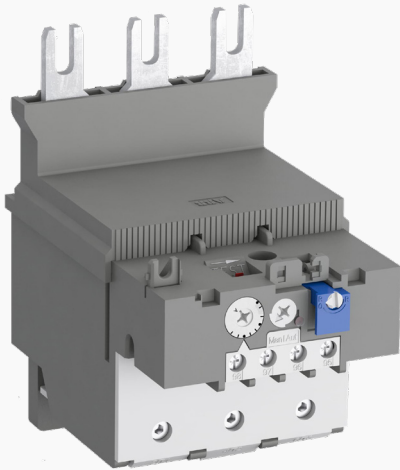

Thermal overload relays are economic electromechanical protection devices for the main circuit. They are used mainly to protect motors against overload and phase failures. Starter combinations are setup together with contactors.

Description

- Overload protection – trip class 10A
- Phase loss sensitivity
- Temperature compensation from -25...+55 °C
- Adjustable current setting for overload protection
- Automatic or manual reset selectable
- Suitable for three- and single-phase application
- Trip-free mechanism
- Status indication
- STOP and TEST function
- Direct mounting onto block contactors



Order data

TF140DU and TF140DU-V1000 screw terminals for AF contactors

Setting range	Type	Order code	Weight Pkg (1 pce) kg
A			
66 ... 90	TF140DU-90	1SAZ431201R1001	0.820
80 ... 110	TF140DU-110	1SAZ431201R1002	0.820
100 ... 135	TF140DU-135	1SAZ431201R1003	0.820
110 ... 142	TF140DU-142	1SAZ431201R1004	0.820
66 ... 90	TF140DU-90-V1000	1SAZ431301R1001*	0.820
80 ... 110	TF140DU-110-V1000	1SAZ431301R1002*	0.820
100 ... 135	TF140DU-135-V1000	1SAZ431301R1003*	0.820
110 ... 142	TF140DU-142-V1000	1SAZ431301R1004*	0.820

Suitable for mounting on AF116 and AF140

* With ATEX certification

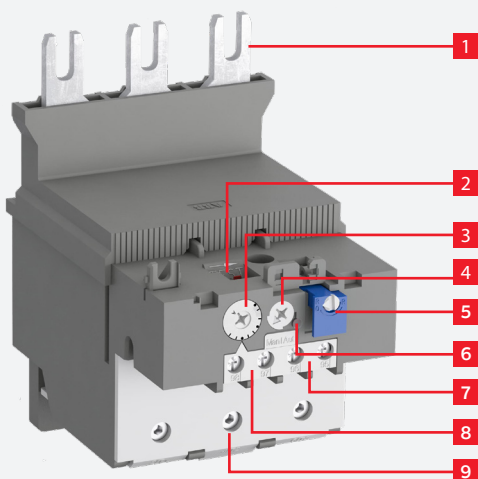

Functional description

1. Terminals 1L1, 3L2, 5L3
2. TEST
3. Current setting range
Adjustable current setting for overload protection
4. RESET
5. Automatic or manual reset selectable
6. RESET-STOP or RESET selectable
7. Status indication
7. Tripping contacts 95-96
8. Signaling contacts 97-98
9. Terminals 2T1, 4T2, 6T3

Application / internal function

The thermal overload relays are three pole relays with bimetal tripping elements (1 per pole). The motor current flows through the bimetal tripping elements and heats them directly and indirectly. In case of an overload (over current), the bimetal elements become bent as a result of the heating. This leads to a release of the relay and a change of the contacts switching position (95-96 / 97-98). The contact 95-96 is used to control the load contactor.

The overload relays have a setting scale in Amperes, which allows the direct adjusting of the relay without any additional calculation. In compliance with international and national standards, the setting current is the rated current of the motor and not the tripping current (no tripping at $1.05 \times I$, tripping at $1.2 \times I$; I = setting current). The relays are constructed in way that they protect themselves in the event of an overload. The overload relay has to be protected against short-circuit. The appropriate short-circuit protective devices are shown in the table.

Operation mode

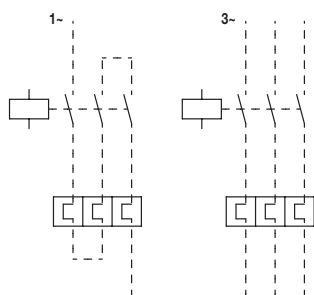

Press blue button	Contact	Relay tripped		Relay not tripped	
		Manual RESET	Automatic RESET	Manual RESET	Automatic RESET
-	95-96	open	open	closed	closed
	97-98	closed	closed	open	open
Button R - RESET function	95-96	closes when button is pressed	-	-	-
	97-98	opens when button is pressed	-	-	-
Button R/O - RESET and STOP function	95-96	closes when button is pressed	-	opens when button is pressed, closes when button is released	opens when button is pressed, closes when button is released
	97-98	opens when button is pressed	-	-	-
TEST	95-96	-	-	open	open
	97-98	-	-	closed	closed while TEST button is operated

Wiring diagram

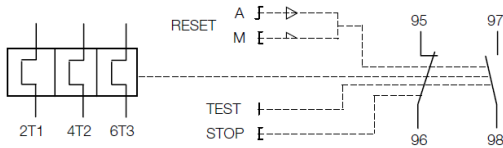

Operation mode 1-phase / 3-phase

Resistance and power loss per pole and Short-circuit protective device

Type	Setting range		Resistance per pole mΩ	Power loss per pole		Short-circuit protection device coordination type 2
	lower value A	upper value A		at lower value W	at upper value W	
TF140DU-90	66	90	0.540	2.4	4.4	200 A, gG Type Fuses
TF140DU-110	80	110	0.378	2.4	4.6	224 A, gG Type Fuses
TF140DU-135	100	135	0.318	3.2	5.8	224 A, gG Type Fuses
TF140DU-142	110	142	0.255	3.1	5.1	250 A, gG Type Fuses
TF140DU-90-V1000	66	90	0.540	2.4	4.4	200 A, gG Type Fuses
TF140DU-110 V1000	80	110	0.378	2.4	4.6	224 A, gG Type Fuses
TF140DU-135 V1000	100	135	0.318	3.2	5.8	224 A, gG Type Fuses
TF140DU-142 V1000	110	142	0.255	3.1	5.1	250 A, gG Type Fuses

Technical diagrams

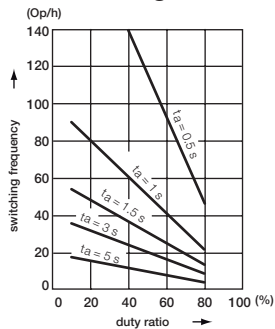

Intermittent periodic duty, ta: Motor starting time

Main dimensions
in mm, inches

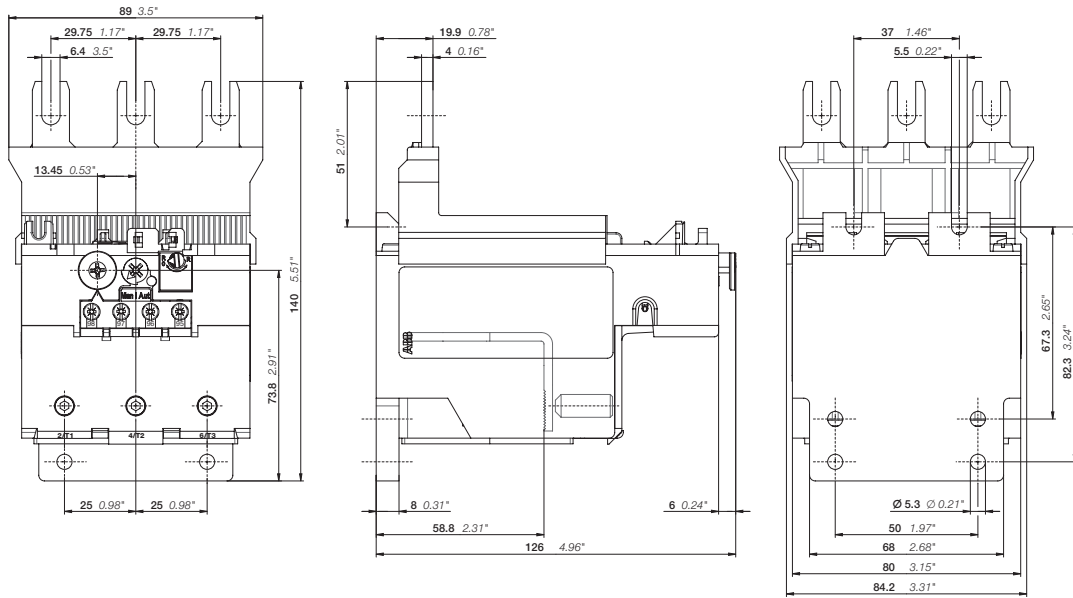

TF140DU, TF140DU-V1000





Technical data IEC/ENData at $T_A = 40\text{ °C}$ and at rated values, if nothing else indicated**Main circuit**

Terminal marking	TF140DU, TF140DU-V1000
Rated operational voltage U_e	690 V AC
	440 V DC
Setting range - thermal overload protection	see table on page 1
Rated operational current AC-3 I_e	see upper value of setting range, see table on page 3
Trip class	10A
Rated frequency	50/60 Hz
Number of poles	3
Resistance per pole	see table on page 3
Power loss per pole	see table on page 3
Short-circuit protective devices	see table on page 3

Isolation data

Rated impulse withstand voltage U_{imp}	8 kV
Rated insulation voltage U_i	690 V
Pollution degree	3
Overvoltage category	Up to III

Electrical connection

Type	TF140DU, TF140DU-V1000
 solid	1 x 16...70 mm ² 2 x 16...70 mm ²
 stranded	1 x 16...70 mm ² 2 x 16...70 mm ²
 flexible with ferrule	1 x 16...70 mm ² 2 x 16...70 mm ²
 flexible with ferrule insulated	1 x 16...70 mm ² 2 x 16...70 mm ²
 flexible without ferrule	1 x 16...70 mm ² 2 x 16...70 mm ²
Stripping length	25 mm
Tightening torque	8 ... 10 Nm
Recommended screw driver	M8 Hexagon





Auxiliary circuit

Terminal marking	95-96, 97-98	
Rated operational voltage U _e	500 V AC, 440 V DC	
Conventional free air thermal current I _{th}	N.C., 95-96	10 A
	N.O., 97-98	6 A
Rated frequency	50/60 Hz	
Number of poles	1 N.C. + 1 N.O.	
Rated operational current I _e acc. to IEC/EN 60947-5-1 for utilization category		
at AC-15 at 110-120 V	N.C., 95-96	3.00 A
	N.O., 97-98	1.5 A
at AC-15 at 220-230-240 V	N.C., 95-96	3.00 A
	N.O., 97-98	1.20 A
at AC-15 at 440 V	N.C., 95-96	0.75 A
	N.O., 97-98	0.37 A
at AC-15 at 480-500 V	N.C., 95-96	0.30 A
	N.O., 97-98	0.25 A
at DC-13 at 24 V	N.C., 95-96	1.25 A
	N.O., 97-98	1.25 A
at DC-13 at 60 V	N.C., 95-96	0.25 A
	N.O., 97-98	0.25 A
at DC-13 at 110-120-125 V	N.C., 95-96	0.25 A
	N.O., 97-98	0.25 A
at DC-13 at 250 V	N.C., 95-96	0.12 A
	N.O., 97-98	0.04 A
Minimum switching capacity	17 V / 3 mA	
Short-circuit protective device	N.C., 95-96	10 A, Type gG
	N.O., 97-98	6 A, Type gG

Isolation data

Rated impulse withstand voltage U _{imp}	6 kV
Rated insulation voltage U _i	690 V
Pollution degree	3
Overvoltage category	Up to III

Electrical connection

Type	95-96, 97-98
 solid	1/2 x 0.75...4 mm ²
 stranded	1/2 x 0.75...4 mm ²
 flexible with ferrule	1/2 x 0.75...2.5 mm ²
 flexible with ferrule insulated	1/2 x 0.75...2.5 mm ²
 flexible without ferrule	1/2 x 0.75...2.5 mm ²
Stripping length	9 mm
Tightening torque	0.8...1.2 Nm
Recommended screw driver	M3.5 (Pozidriv 2)

General data

Duty time		100%
Operating frequency without early tripping		up to 15 operations/h or 60 operations/h with 40% duty ratio, if the motor breaking current $6 \times I_n$ and the motor starting time does not exceed 1 s
Dimensions (W x H x D)		see drawing "Dimensions"
Weight		see table "Order data"
Mounting		mount on the contactor and tighten the screws of the main circuit terminals
Mounting position		optional, position 1-5
Minimum distance to other units same type	horizontal	5 cm
	vertical	not applicable
Minimum distance to electrical conductive board	horizontal	none
	vertical	None
Degree of protection	housing	IP20
	main circuit terminals	IP10
Altitude		up to 2000 m

Environmental data

Ambient air temperature		
Operation	open - compensated	-25...+55 °C
	open	-25...+55 °C
Storage		-40...+70 °C
Ambient air temperature compensation		acc. to IEC/EN 60947-4-1
Resistance to vibrations acc. to IEC/EN 60068-2-6 (Fc)		1g / 3...150 Hz
Resistance to shock acc. to IEC 60068-2-27(Ea)		12g / 11 ms

Standards / directives

Standards	IEC/EN 60947-1 IEC/EN 60947-4-1 IEC/EN 60947-5-1 UL 60947-1 UL 60947-4-1
Low Voltage Directive	2006/95/EC
EMC Directive	2004/108/EC
RoHS Directive	2002/95/EC

Technical data UL/CSA



Full load amps and short-circuit protective devices

Type	Full load amps (FLA)	Short-circuit protective device					
		480 / 600 V AC		480 / 600 V AC		480 / 600 V AC	
		Short circuit rating RMS symmetrical	Fuse type	Short circuit rating RMS symmetrical	Fuse type	Short circuit rating RMS symmetrical	Listed circuit breaker
TF140DU-90	90 A	10 kA	250 A, K5 / RK5	100 kA	250 A, Class J	100 kA	250 A
TF140DU-110	110 A	10 kA	250 A, K5 / RK5	100 kA	250 A, Class J	100 kA	250 A
TF140DU-135	135 A	10 kA	250 A, K5 / RK5	100 kA	250 A, Class J	100 kA	250 A
TF140DU-142	142 A	10 kA	250 A, K5 / RK5	100 kA	250 A, Class J	100 kA	250 A

Main circuit

Max. operational voltage	600 V AC
Trip rating	125% of FLA
Full load amps (FLA)	see table above
Short-circuit rating RMS symmetrical	see table above
Short-circuit protective device	see table above

Electrical connection

Type	TF140DU, TF140DU-V1000	
 stranded	1/2 x AWG 6...2/0	
 flexible without ferrule	1/2 x AWG 6...2/0	
Stripping length	25 mm	
Tightening torque	77...88 lb-in	
Recommended screwdriver	M8 (Hexagon)	

Auxiliary circuit

Conventional thermal current	N.C., 95-96	10 A
	N.O., 97-98	6 A
Making and breaking capacity	N.C., 95-96	B600
	N.O., 97-98	C300

Electrical connection



Type	95-96, 97-98	
 stranded	1/2 x AWG 18...14	
 flexible without ferrule	1/2 x AWG 18...14	
Stripping length	9 mm	
Tightening torque	12 lb-in	
Recommended screwdriver	M3.5 (Pozidriv 2)	



ABB STOTZ-KONTAKT GmbH
Electrification Business
Low Voltage Products and Systems
Eppelheimer Straße 82
D-69123 Heidelberg / Germany
Phone: +49 (0) 6221 7 01-0
Fax: +49 (0) 6221 7 01-13 25
E-Mail: info.desto@de.abb.com

We reserve the right to make technical changes or modify the contents of this document without prior notice. With regards to purchase orders, the agreed particulars shall prevail. ABB AG does not accept any responsibility whatsoever for potential errors or possible lack of information in this document.

We reserve all rights in this document and in the subject matter and illustrations contained therein. Any reproduction, disclosure to third parties or utilization of its contents – in whole or in parts – is forbidden without prior written consent of ABB AG.

Copyright© 2024 ABB - All rights reserved