

Pipeline Management Systems with MicroSCADA



ABB Process Industries



Pipeline Networks – Now and in the Future

2

Pipeline networks are becoming ever more complex, and the supply of power in many countries depends on problem-free deliveries of gas and oil. What's more, the demands placed on the pipeline operators are continually increasing. As their task becomes increasingly complex, in order to manage it efficiently they need ever more exact and up-to-date information. It is, therefore, already virtually impossible to run an efficient pipeline operation without sophisticated software applications and appropriate automation.

The highest priority in this field is given to safety of supply and to protection of the environment. These tasks mean that a professional pipeline management system needs to be used right through from the "source", over the transport network and as far as the consumer. Such a system can reliably ensure that gas, oil or oil products are delivered to the right customer in line with demand, maintaining the right cost and quality, and above all meeting any deadlines. Especially with regard to environmental protection, an exceptionally high degree of safety is required for operating pipelines. Disrupted supply or worse still – shutdown are to be avoided whatever the circumstances; leakages must be discovered, localized and rectified as swiftly as possible. To help with this task the operator needs to have appropriate software tools for measurement in connection with invoicing, for production planning, for maintenance planning and for analyzing flow problems.

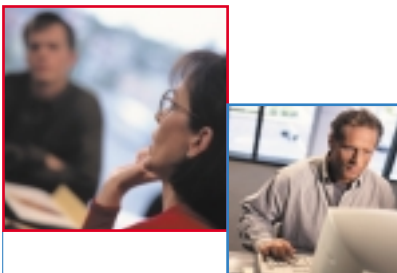

The requirements for system solutions appear to be contradictory. On the one hand, a solution must be appropriate to the pipeline in question, which requires a large amount of adjustment input, while on the other hand there is a requirement for solutions that are proven in a practical situation. This precludes the option of customized, unique solutions. Instead there is a call for modular solutions, which may be provided by a single source but developed by a variety of different specialists and firms. In consequence, it is far from easy to guarantee that such a solution will function as required.

The Pipeline-Management-System (**PMS**), on the other hand, provides ABB with a comprehensive strategy for monitoring and controlling networks of oil and gas pipelines. Thanks to its open architecture, this system is flexible and can also be adapted for unusual requirements. New features can be installed easily, even retrospectively. ABB has extensive expertise and experience accumulated over decades in process control.

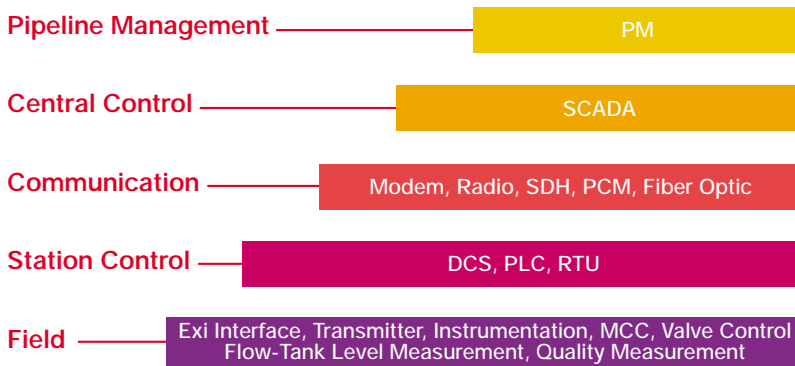

According to their customers' specific requirements, ABB selects the appropriate components and combines them to form a customized system solution. The widest variety of subsystems in the stations are integrated, including flow measurement equipment, tank measurement systems, systems ranging from simple pump control to complex automation systems, as well as stand-alone systems for process control in a compressor station. The integration effort involves consortium partners, suppliers, project planning, project management, training, and – last but not least – after-sales service. The result of this operation is the optimization not of individual components but of the entire process.

Standard components, modular technology, parameter control and object-oriented libraries allow the delivery of affordable standard solutions tailored to the customer's specifications. At the same time, this design enhances the overall reliability of the system. PMS users also benefit from the advantages of a compatible system design which is constantly undergoing further development. Other advantages of **PMS**: shorter implementation time scales, lower risks, less problematic interfaces and a greater degree of flexibility.

Project Execution is accomplished by Project Task Force Management Principle. An international experienced Project Manager heads a Project Task Force Team with equally experienced Sub-Managers for the various disciplines of the project who are drawing other resources from ABB's world wide resource pools.

This Project Management Team is guided by six basic functions: Leadership, Definition, Planning, Organisation, Controlling and Closing.

In order to achieve the goals of a successful Project Management, proven tools of management have been developed, like the project manual, containing the statement of work, the project work breakdown structure, the project schedule and budget as well as clear job function descriptions accompanied by project procedures describing performance and project requirements thus providing the path for accomplishing the goals and objectives for successful Project Management.

ABB – Your Partner for Pipeline Automation



4

ABB has been working for many years and gained a great deal of experience in the international field of pipeline automation. Our customers in Europe and all over the world value us as a reliable system partner. We are also actively involved with producing the integration interfaces in international committees.

We are thus well-qualified to team up with you and offer you the support of our expertise.

ABB offers an affordable product named MicroSCADA, which handles tasks on the control level of pipeline network operation. This product provides you with a platform for delivering solutions to optimization tasks as well as the classical SCADA tasks (supervisory control and data acquisition) in the operational management of pipelines. Our worldwide experience in numerous fields ensures a control system that is always up-to-date, while also being time-proven.

We orient ourselves to the changing demands in information technology development. The SCADA functions for operational management of pipeline networks for all types of energy are complemented by the energy management applications, EMA. These contain modular optimization functions and load management functions, adaptable interfaces for linking in other applications, and the pipeline modeling function.

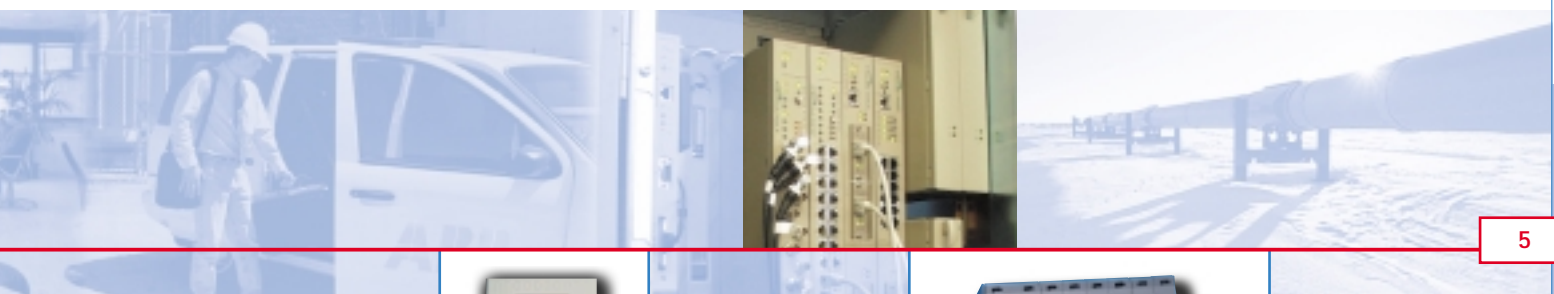

Suitable for use in many different fields

MicroSCADA is a scalable SCADA system with ready-made applications and customization facilities. Its intelligent, modular structure enables it to offer excellent facilities for combining basic functions and flexibility. It is therefore a control system for application fields in which energy management functions are based on extensive SCADA tasks.

The application fields for the system are transport and supply networks ranging in size from fairly small to extensive, and for power in different forms such as oil, gas and others.

Our main target groups are:

- Transport pipelines for crude oil and product pipelines
- Transport pipelines for gas
- Pipelines for regional and urban gas distribution
- Networks for collecting oil and gas from source points

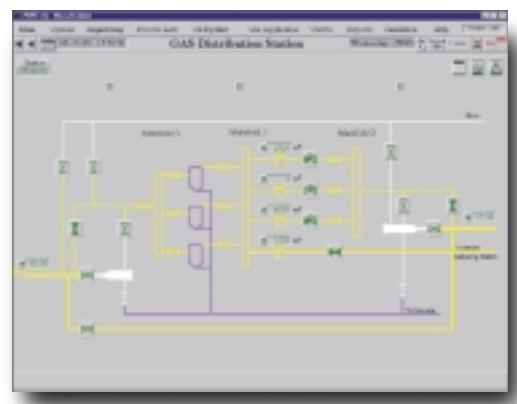

Functions for Pipeline Operation Management

6

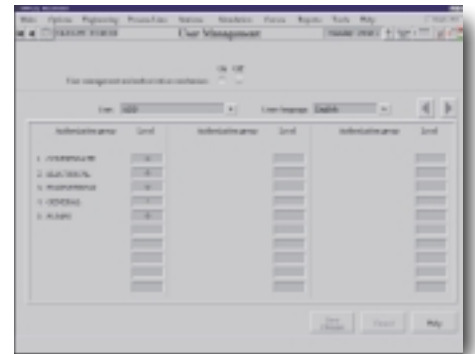

MicroSCADA combines user-friendly operator control with the facility for wide-ranging information processing.

Human Machine Interface

MicroSCADA has its own adaptable, Windows-based design of Human Machine Interface (HMI). The most important aspects of the operator interface are its user-friendliness and the ease with which it can be learnt. Its freely-configurable displays make all manner of different displays feasible, including 3D.

In accordance with ergonomic viewpoints, the system uses designed process displays to provide the user with information from the process and to make operation as simple, safe and efficient as possible.

User management – in line with the demands of operational management

In **MicroSCADA** several networks or part-networks can be managed in a single application. Irrespective of whether they are supervised by only one person or whether specialized staff are assigned to each area, access to functions and areas of operation is enabled by the priority-driven user management system.

The options for combining group allocations and access rights are virtually unlimited. Furthermore, each user can be allocated their own language for the text elements of the user interface.

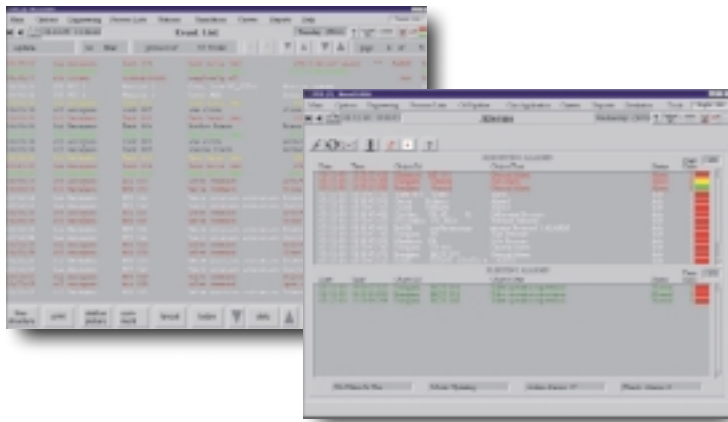

Flow visualization through dynamic coloring

Flow visualization offers users particularly valuable support by clearly displaying the flow paths in stations and tank farms.

All interconnected pipelines and objects are displayed in the same color. This function is used, for example, in tank farms. It shows the operator which tanks, pipelines and pumps are linked together. When the gate valves or pump states are altered, the operator can immediately see the new flow path.

Logs as required

The logs can be adapted to suit the operational demands, and provide the user with convenient facilities for selecting information as well as choosing an appropriate fault analysis. The length of logs is also adjustable, and paperless operation is therefore not an issue.

Other lists and functions provide the operator with a rapid and comprehensive overview of their plant and the control system. These are the alarms list, the list of inhibited commands and messages, archive analyses, operating time count, notebook and system monitoring displayed in graphical form.

Flexible Online Engineering

8

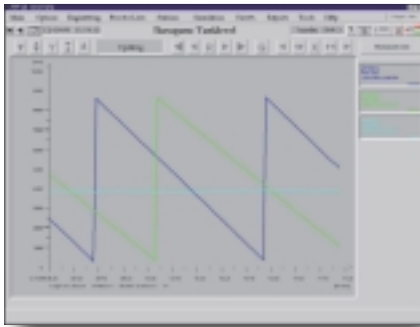
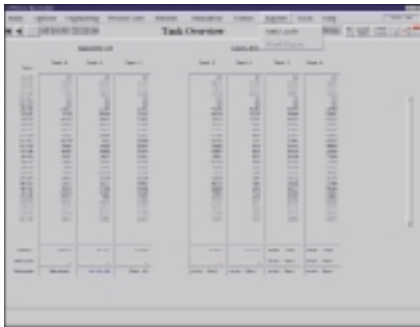

MicroSCADA is a modular, scalable system which is easy to upgrade and can therefore be adapted economically for a growing number of process variables and increasing complexity.

It can be easily upgraded both in physical and functional respects without altering the original application. This is made possible because convenient, powerful engineering tools and the applications programming language SCIL (developed inhouse, and easy to learn) along with its enhanced version VisualSCIL are all available in the basic functions. Using SCIL and VisualSCIL, even the user in the customer organization is capable of generating their own specific functional enhancements or additions to the system configuration.

The generous degree of flexibility and the open platform ensure that the system is able to grow as needed over the years, thus safeguarding your investment.

Engineering tasks and data entry can be performed on-line and in parallel with operational management.

Archives and reports

The archive analyses are extremely complex and versatile. The large number of parameters make them ideally suited for comparisons, displays of dependencies between individual process variables and of course for process monitoring. Reports contain cyclical data sorted according to points of measurement and time scale.

Reports can be defined exactly to the user's specification using the report generator.

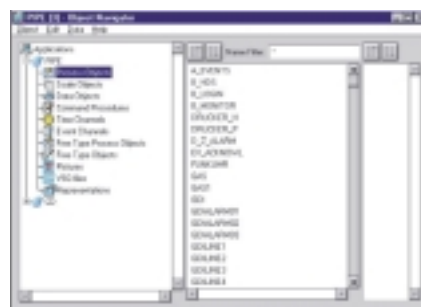
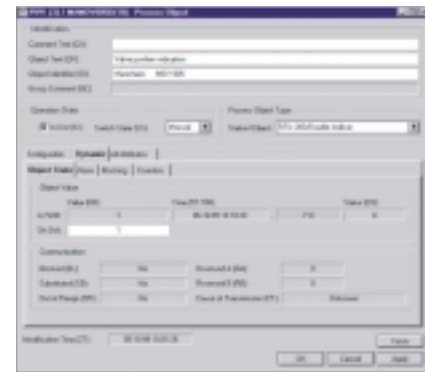

Easy data entry

MicroSCADA provides you with a comprehensive package for data entry, whose clarity and efficient structure make it easy to use.

A fully-graphical display editor provides you with the kind of drawing and editing functions that you are familiar with from commercial programs.

There are comprehensive libraries of the LIB500 to fall back on when it comes to incorporating dynamic display elements.

But even in cases when the requirements demand function over and above those contained in the generously-stocked libraries – for example when automated special functions or customized dialogs need to be created – there are easy-to-use tools on hand.

An object-oriented development environment with full graphical support enables dialogs to be created. The graphical display can be upgraded at any time by importing or directly calling up standard graphics formats such as GIFs or bitmaps.

Likewise, object-oriented and easy-to use tools are also provided for creating automatic functions; command procedures and their event-driven or time-driven control can, for example, be linked with these.

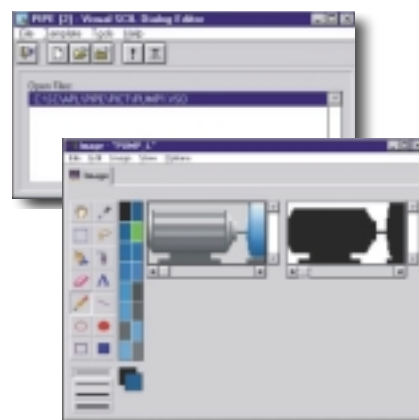

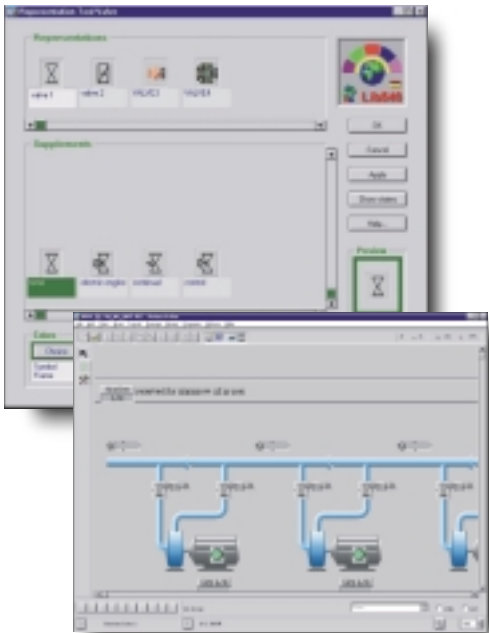

Pipeline process library

The pipeline process library LIB540, as part of the LIB500 family, represents the crucial tool for the efficient and secure creation of operating displays for pipeline applications.

It contains pre-prepared display elements for equipment that features in the pipeline process. This includes valves, pumps, measurement values, fill-level displays, set-point defaults, status functions and alarm functions. Many different kinds of configuration options enable displays to be adapted for various designs and types of equipment.

During data entry and in accordance with the selection of the display element at various sizes, the graphic display is selected and configured in a single step.

After installation, not only the process displays with dynamic display elements and database objects are available in the appropriate lists of reports and alarms, but also there are the complete operator functions with dialogs as well as the alarm processing and event processing and their displays.

In the selection dialog for the graphical display of the display element, color codes may also be selected for the equipment states and orientation states.

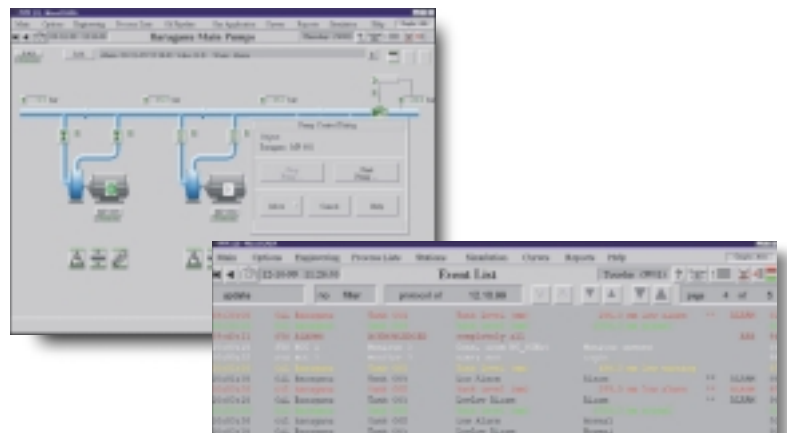
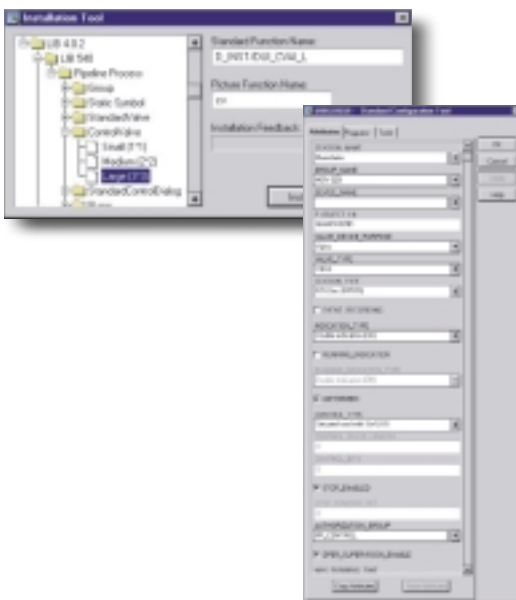

Open and Distributed System Structure

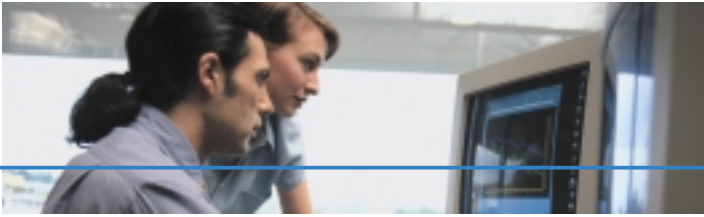

MicroSCADA is modular in hardware configuration. It consists of basic systems, workstations, communication units, process units and a local network (LAN). The basic systems and workstations are high-quality, standard commercial workstations and servers operating under Windows NT®. When the availability requirements are particularly high, redundant systems are used in hot-standby mode.

We use all the standards for open systems in order to ensure the greatest possible flexibility in the system for the user. This basic system design allows to be further upgraded and allows additional functions to be added throughout the lifecycle of the system.

Local or remote workstations are available for plant management, linked with the basic system over the LAN (local area network), WAN (wide area network) or other fast connections. Telecommunications services and the internet can also be linked up. For exchanging data with the commercial world and expert systems and for linking to station control systems, the API, ODBC, DDE and OPC interfaces are provided. The workstations make use of full graphics at a high resolution of up to 1600 x 1200 pixels.

The process is linked via back-up computers, gateways, or direct via LAN/WAN using TCP/IP. A large number of process units can be connected: remote-action substations from ABB and other suppliers, programmable logic controllers and process units from other manufacturers. The IEC 870-5-101 protocol is normally used for remote transmission, while MODBUS and PROFIBUS® are used in the field.

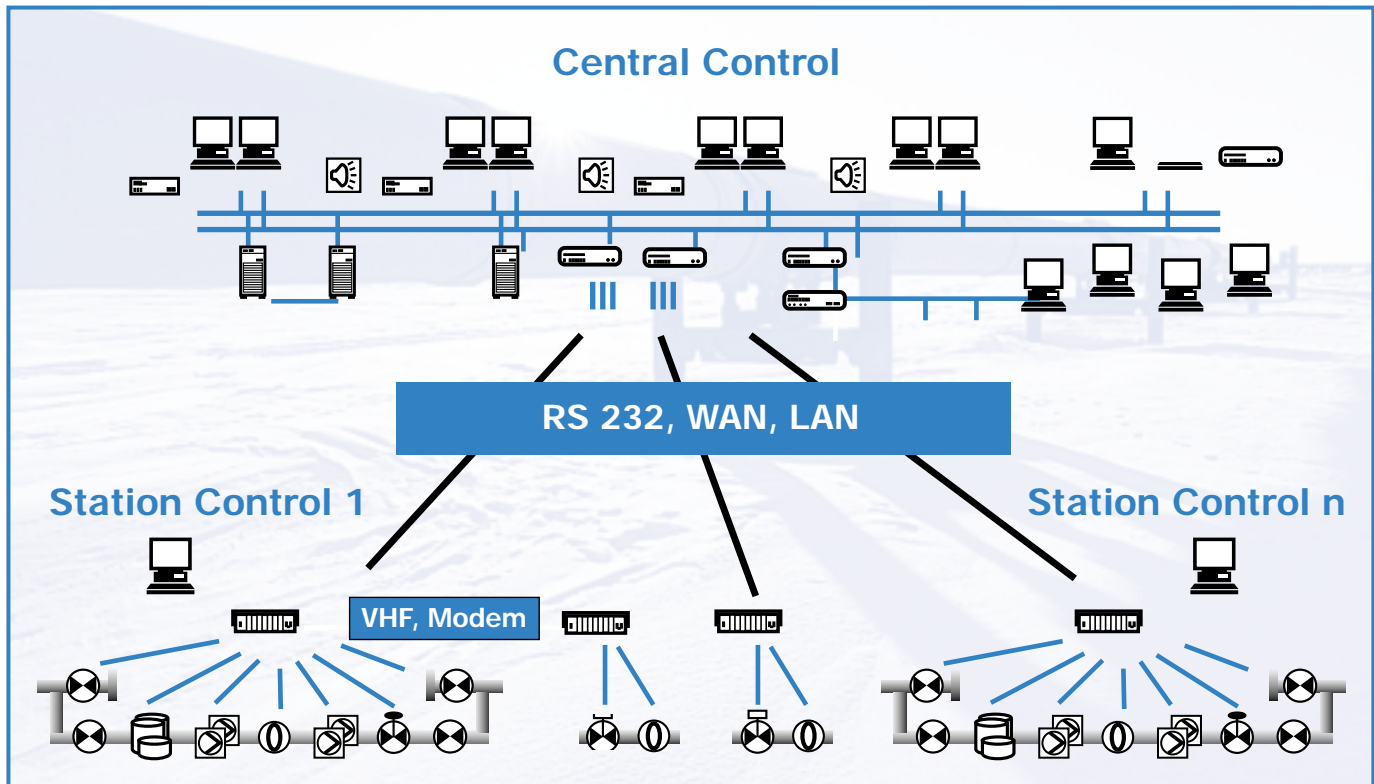



ABB Process Industries GmbH

Dudenstrasse 44-46
D-68167 Mannheim
Germany
Phone +49 621 381 6500
Fax +49 621 381 7737
www.abb.com/pipc