

# ABB-Welcome

83210-AP-xxx-500  
Audio hands-free Indoor  
station

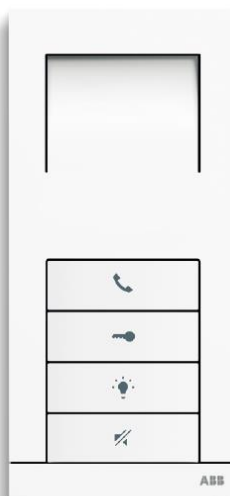

1	Safety .....	3
2	Intended use.....	3
3	Environment .....	3
	3.1 ABB devices .....	3
4	Operations.....	5
	4.1 Standard operations .....	5
	4.1.1 Control elements .....	5
	4.2 Setting .....	7
	4.2.1 Set Indoor station address (X200, X100).....	7
	4.2.2 Set function of light button .....	7
	4.2.3 Set ringtone type .....	8
	4.2.4 Set repeated ringtone .....	8
	4.2.5 Set ringtone volume.....	8
	4.2.6 Set speech volume .....	8
	4.3 Adjusting the device.....	9
5	Technical data .....	10
6	Mounting / Installation.....	11
	6.1 Requirements for the electrician .....	11
	6.2 General installation instructions .....	12
	6.3 Mounting.....	13

## 1 Safety



### Warning

#### Electric voltage!

Risk of death and fire due to electrical voltage of 100-240 V.

- Work on the 100-240V supply system may only be performed by authorised electricians!
- Disconnect the mains power supply prior to installation and/or disassembly!

## 2 Intended use

This device is an integral part of the ABB-Welcome door communication system and operates exclusively with components from this system. The device must only be installed in dry indoor rooms.

## 3 Environment



### Consider the protection of the environment!

Used electric and electronic devices must not be disposed of with domestic waste.

- The device contains valuable raw materials which can be recycled. Therefore, dispose of the device at the appropriate collecting depot.

### 3.1 ABB devices

All packaging materials and devices from ABB bear the markings and test seals for proper disposal. Always dispose of the packaging material and electric devices and their components via the authorized collecting depots and disposal companies.

## ABB-Welcome

---

ABB products meet the legal requirements, in particular the laws governing electronic and electrical devices and the REACH ordinance.

(EU-Directive 2002/96/EG WEEE and 2002/95/EG RoHS)

(EU-REACH ordinance and law for the implementation of the ordinance (EG)

No.1907/2006)

## 4 Operations

### 4.1 Standard operations

#### 4.1.1 Control elements

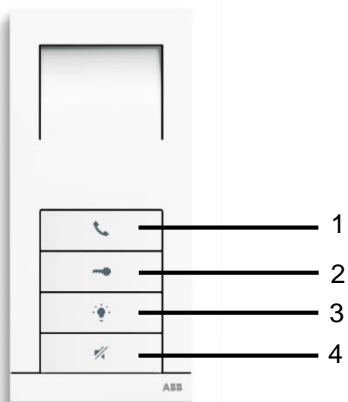

Fig. 1 Control elements

# ABB-Welcome

---

<b>No.</b>	<b>Functions</b>
1	<b>Communication button</b> 1A When a call is coming, press this button to activate the communication within 30 seconds and press it again to end the call. 1B In standby mode, press this button to enter the communication menu.
2	<b>Unlock button</b> 2A Press this button to open the door at any time. 2B Auto-unlock: the door is automatically opened after an incoming call (Hold this button for more than 10 seconds until the backlit LED turns on, Tthe same operation will switch off the function and LED will be turned off ).
3	<b>Light button</b> 3A Switch the lighting (default function) 3B Long press for 3s to enter setting mode for additional functions, e.g. call to Guard unit, Room to romm intercom and open the 2 <sup>nd</sup> lock
4	<b>Mute button</b> 4A In standby mode, press this button to mute ringtone of the indoor station. 4B In standby mode, hold the button to mute ringtone of all indoor stations in the apartment. 4C When a call is coming, press this button to reject the call. 4D During the conversation, press this button to mute microphone. The LED illuminates to indicate mute status.

---

# ABB-Welcome

## 4.2 Setting

### 4.2.1 Set Indoor station address (X200, X100)

Step1: hold "light" button  for 3s to enter setting mode (4 LEDs are on)

Step2: hold "talk" button  for 3s to enter the setting of X200/X100.

Step3: press "mute" button  to change the number.

The value is indicated by LED of each button.(Default value =0)

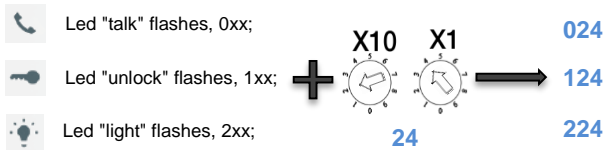

Step4: hold "light" button  for 3s to enter setting mode (4 LEDs are off)





### 4.2.2 Set function of light button

Step1: hold "light" button  for 3s to enter setting mode (4 LEDs are on)

Step2: hold "unlock" button  for 3s to enter the setting of light button.

Step3: press "mute" button  to change the function.

The value is indicated by LED of each button.(Default value =0)

-  Led "Talk" flashes, switching the lighting;
-  Led "Unlock" flashes, opening the 2nd lock
-  Led "Light" flashes, room to room intercom
-  Led "Mute" flashes, call Guard unit

Step4: hold "light" button  for 3s to enter setting mode (4 LEDs are off)



# ABB-Welcome

---

## 4.2.3 Set ringtone type

Step1: hold "light" button  for 3s to enter setting mode (4 LEDs are on)

Step2: press button like below to change ringtone.

-  press "Unlock" button to set ringtone type of door bell.
-  press "Light" button to set ringtone type of room to room intercom or call Guard unit
-  press "Mute" button to set ringtone type of Outdoor station or Gate station

Step3: hold "light" button  for 3s to enter setting mode (4 LEDs are off)

## 4.2.4 Set repeated ringtone

Step1: hold "light" button  for 3s to enter setting mode (4 LEDs are on)

Step2: hold "mute" button for 3s  to repeat the ringtone or not.

Step3: hold "light" button  for 3s to enter setting mode (4 LEDs are off)

## 4.2.5 Set ringtone volume

Step1: hold "light" button  for 3s to enter setting mode (4 LEDs are on)



Step2: press "talk" button  to enter the ringtone volume setting

Step3: press "mute" button  to adjust the ringtone volume

Step4: hold "light" button  for 3s to enter setting mode (4 LEDs are off)

## 4.2.6 Set speech volume

*The setting must be under the communication*

Step1: hold "light" button  for 3s to enter setting mode (LED  flashes)

Step2: press "light" button  to adjust the volume

Step3: hold "light" button  for 3s to enter setting mode



## 4.3 Adjusting the device

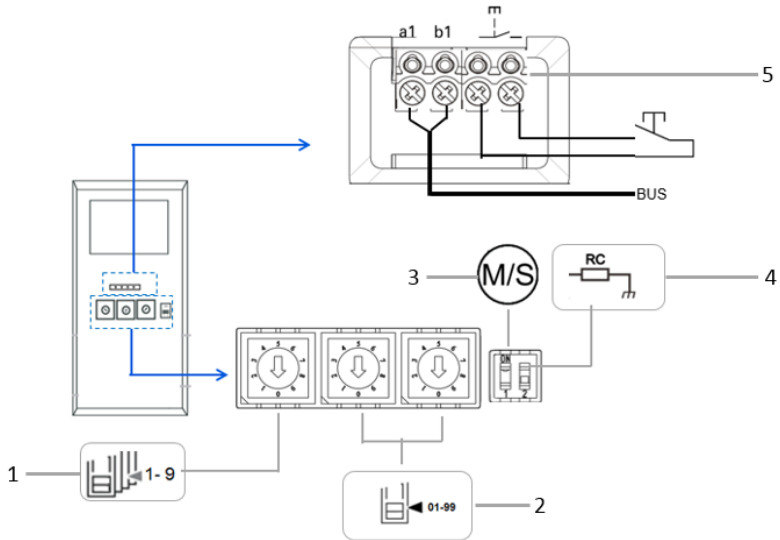

Fig. 2:

### 1. Station

Selector switch to set the address of default outdoor station.

### 2. X10 X1

Selector switches to set the address (tens and units digits) of the indoor station.

### X100 X200

Set through "light" button.

### 3. Master /Slave function

Only one indoor station in each apartment must be set as "Master" (Switch should be set as 'M/S on'). All additional indoor stations in the same apartment must be set as "Slave" (Switch should be set as 'M/S off').

### 4. Terminal resistor

In video installations or mixed audio and video installations, the Switch must be set as 'RC on' on the last device of the line.

### 5. a b = Bus connection

 = Door bell connection

## 5 Technical data

<b>Designation</b>	<b>Value</b>
Operating temperature	-10° C - +55° C
Storage temperature	-40° C – +70° C
Protection	IP 30
Single-wire clamps	2 x 0.28 mm <sup>2</sup> – 2 x 0.75 mm <sup>2</sup>
Fine-wire clamps	2 x 0.28 mm <sup>2</sup> – 2 x 0.75 mm <sup>2</sup>
Bus voltage	20-30 V
Size	175 x 81 x 22 mm

## 6 Mounting / Installation



### Warning

#### Electric voltage!

Risk of death and fire due to electrical voltage of 100-240 V.

- Low-voltage and 100-240 V cables must not be installed together in a flush-mounted socket!

In case of a short-circuit there is the danger of a 100-240 V load on the low-voltage line.

### 6.1 Requirements for the electrician



### Warning

#### Electric voltage!

Install the device only if you have the necessary electrical engineering knowledge and experience.

- Incorrect installation endangers your life and that of the user of the electrical system.
- Incorrect installation can cause serious damage to property, e.g. due to fire.

The minimum necessary expert knowledge and requirements for the installation are as follows:

- Apply the "five safety rules" (DIN VDE 0105, EN 50110):
  1. Disconnect from power;
  2. Secure against being re-connected;
  3. Ensure there is no voltage;
  4. Connect to earth;
  5. Cover or barricade adjacent live parts.
- Use suitable personal protective clothing.
- Use only suitable tools and measuring devices.
- Check the type supply network (TN system, IT system, TT system) to secure the following power supply conditions (classic connection to ground, protective earthing, necessary additional measures, etc.).

## 6.2 General installation instructions

- Terminate all branches of the wiring system via a connected bus device (e.g., indoor station, outdoor station, system device).
- Do not install the system controller directly next to the bell transformer and other power supplies (to avoid interference).
- Do not install the wires of the system bus together with 100-240 V wires.
- Do not use common cables for the connecting wires of the door openers and wires of the system bus.
- Avoid bridges between different cable types.
- Use only two wires for the system bus in a four-core or multi-core cable.
- When looping, never install the incoming and outgoing bus inside the same cable.
- Never install the internal and external bus inside the same cable.

## 6.3 Mounting

### Recommended installation height

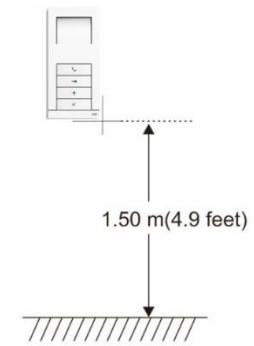

### Dismantling

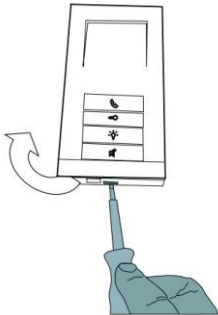

Pull the clamp on the bottom of the device and then open the housing of the panel.

## Installation dimensions for slotted screw holes

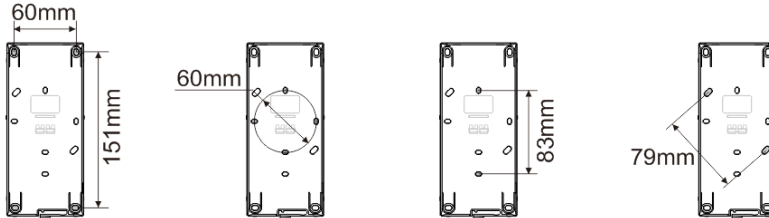

1. The bottom of the device has screw holes for fastening on the wall according to the above dimension instructions.
2. In addition, the bottom of the device can be fixed to the existing flush-mounted box. The dimension of the compatible flush-mounted box is shown above.

## Wiring

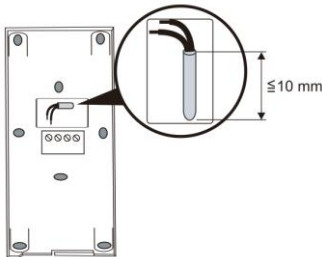

Fix the bottom of the device and connect it with reference to the graphics. The insulated section of the cable end must not be longer than 10mm.

## Settings

Set addresses of the preferred outdoor stations and the address of the indoor station on the jumper (see chapter " [Adjusting the device](#) ").

## Mounted on the wall

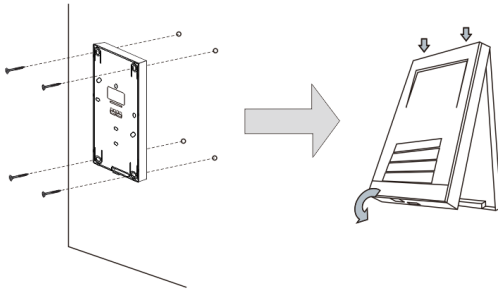

1. Fix the bottom of the device to the wall.
2. Latch the upper part of the device onto its bottom part: place the upper side of the device on the lock-in lugs and then press the bottom side onto the bottom part of the device until it is caught by the clamp.

## Mounted with flush-mounted box

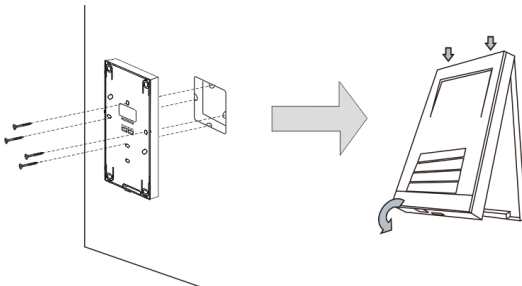

1. Fix the bottom of the device to the existing flush-mounted box.
2. Latch the upper part of the device onto its bottom part: place the upper side of the device on the lock-in lugs and then press the bottom side onto the bottom part of the device until it is caught by the clamp.

The installation of the indoor station is now complete.

# ABB-Welcome

---

## **Notice**

We reserve the right to at all times make technical changes as well as changes in the contents of this document without prior notice.

The detailed specifications agreed to at the time of ordering apply to all orders. ABB accepts no responsibility for possible errors or incompleteness in this document.

We reserve all rights to this document and the topics and illustrations contained therein. The document and its contents, or extracts thereof, must not be reproduced, transmitted or reused by third parties without prior written consent by ABB.