

CATALOG

AFS contactors

Dedicated for safety applications

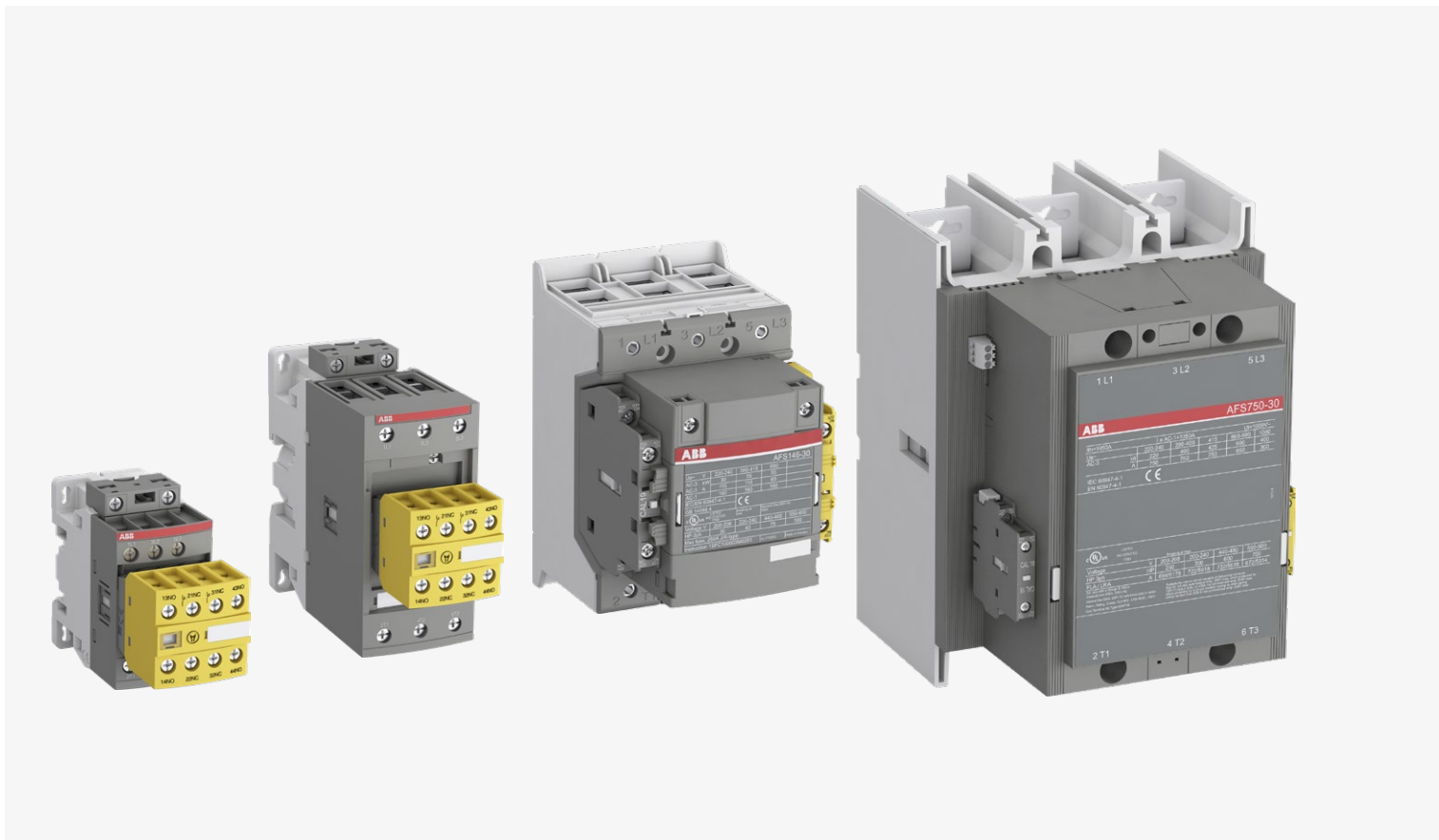

AFS 3-pole contactors dedicated for safety applications

| | | |
|----|---|--|
| 2 | Overview | |
| | Ordering details | |
| | 4 to 45 kW | |
| 10 | AFS09 ... AFS38 | AC / DC operated with 2 N.O. + 2 N.C. |
| 11 | AFS40 ... AFS96 | AC / DC operated with 2 N.O. + 2 N.C. |
| 12 | AFS09 ... AFS96 | Main accessories |
| | 55 to 200 kW | |
| 14 | AFS116 ... AFS146 | AC / DC operated with 1 N.O. + 2 N.C. |
| 15 | AFS116 ... AFS146 | AC / DC operated with 1 N.O. + 2 N.C. with built-in PLC interface |
| 16 | AFS190 ... AFS370 | AC / DC operated with 1 N.O. + 2 N.C. |
| 17 | AFS190 ... AFS370 | AC / DC operated with 1 N.O. + 2 N.C. with built-in PLC interface |
| 18 | AFS09 ... AFS370 | Main accessories |
| | 200 to 400 kW | |
| 20 | AFS400 ... AFS750 | AC / DC operated with 1 N.O. + 2 N.C. |
| 21 | AFS400 ... AFS750 | Main accessories |
| 23 | Technical data | |
| 38 | Terminal marking and positioning | |
| 39 | Electrical durability | |

AFS 3-pole contactors

Dedicated for safety applications

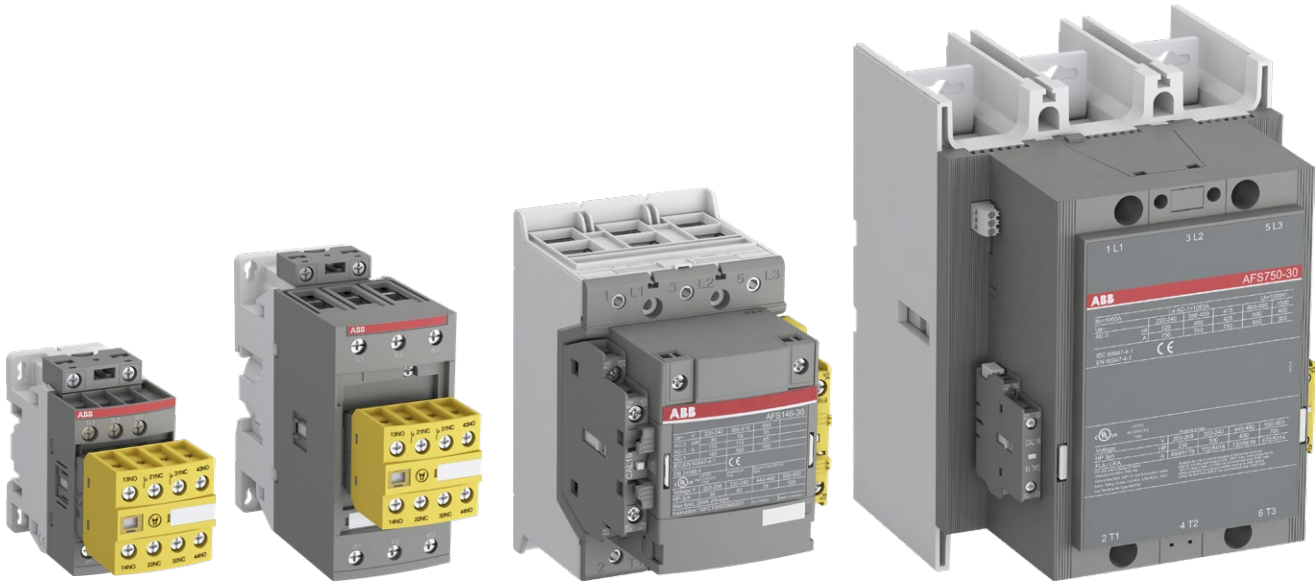

Designed for machine safety applications, AFS contactors now complete ABB's safety component portfolio.

With a range stretching from 9 A up to 750 A for motor starting applications and with a design complying with the latest safety standard, the AFS range of contactors is the given choice for any application that puts the users safety first.



Safety and protection

ABB's AFS contactors can be easily integrated in machine manufacturer's systems complying with main standards EN ISO 13849 and EN 62061 - guaranteeing the safe use of your machinery and equipment. An easily identifiable yellow low energy auxiliary contact block ensures the status feedback circuits required in machine safety applications.



Continuous operation

The AFS contactor secures system uptime. Featuring ABB's tested and proven AF technology, AFS contactors are reliable in any network. Direct control by safety PLCs or safety relays ensures the required safety performance.



Speed up your projects

AFS design makes integration easier. With energy efficient coils smaller transformers can be used and panel space more efficiently used. Wide voltage range coils and easily available safety data simplifies product selection. In addition, all the safety data for the AFS contactors is available using common safety design tools.

AFS 3-pole contactors

Dedicated for safety applications

Guaranteed contactor status

ABB's permanently fixed auxiliary contact blocks guarantee the correct contactor status at all times. Mechanically linked and mirror contacts provide the performance required in feedback circuits. This prevents any unexpected state changes of auxiliary contact if main contacts become welded or stuck and ensures an accurate depiction of the safety system status displayed at all times. Mechanically linked and mirror contact symbols are marked on the yellow auxiliary block.

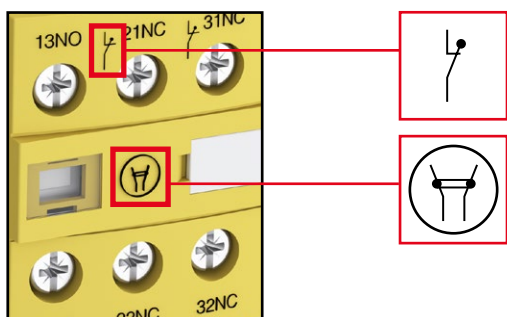

Fast response for increased safety

In safety applications speed is essential to protect operators. AFS contactors feature fast opening times, down to 20 ms for certain PLC controlled contactors, ensuring that when a dangerous failure is detected the operator is kept out of harms way.

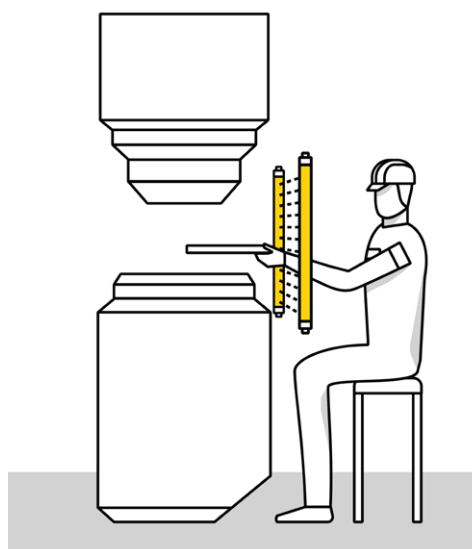

Prevent unexpected operations

Factory fitted auxiliary contact blocks that are permanently fixed protects devices against accidental operation and misuse. A factory-fitted transparent cover on contactors up to 96 A shields the contactor status indicator, providing additional protection from misuse.

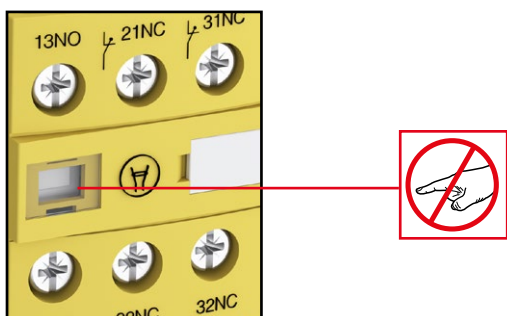

Simplify calculation of your installation safety level

AFS contactor safety data is available in safety design tools Sistema and FSDT, dedicated software for determining the Performance Level (PL) and Safety Integrity Level (SIL) of safety functions and generating technical documentations.

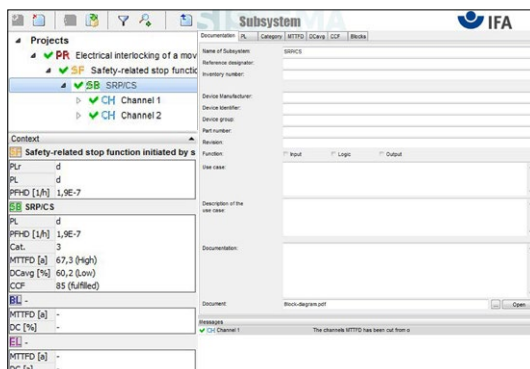

Control by safety PLCs or safety relays

ABB's AFS contactors can be controlled directly by safety PLCs or safety relays, or by a power relay depending on size. AFS contactors is part of the ABB safety family, and selected sizes are tested together with ABB's Pluto safety PLC and the Sentry safety relay. For full coordination please advise ABB. The auxiliary contacts only require a minimum switching capacity of 3 V / 1 mA. They guarantee system status feedback, making the system safe and reliable.

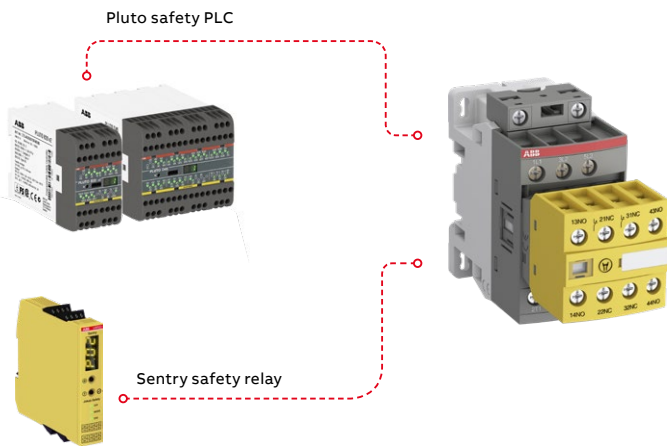

Easy safety chain identification

The yellow housing of ABB's AFS contactors makes identifying the safety product in your panel quicker. During routine maintenance work, ABB's intuitive design saves valuable time.

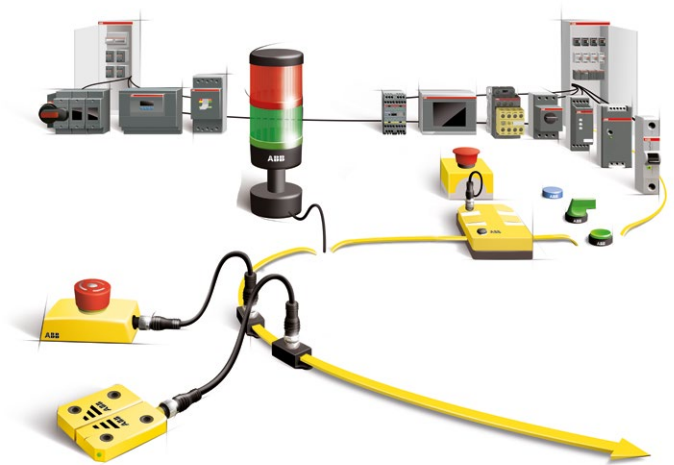

Panel size reduction

Utilizing AF technology, AFS coils need up to 60% less energy than conventional contactor coils. This allows for smaller transformers to be used for contactor control, which in turn allows for more efficient use of panel space. Using AFS contactors saves money and precious space.

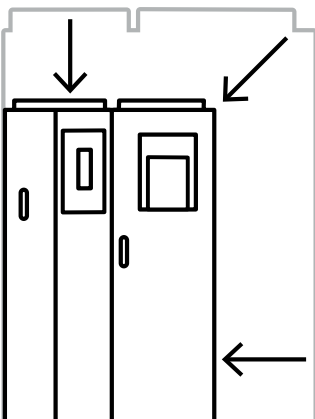

Built-in surge suppression

Unlike conventional contactors, ABB's AFS contactors have built-in surge suppression, preventing surges from ever reaching the control circuit. With no need for the usual external surge suppressor add-ons, ABB's solution means one less device to install and one less complication to manage.

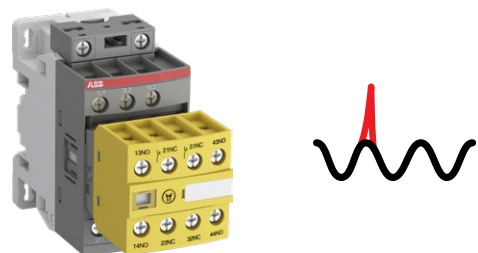

AFS 3-pole contactors

A part of ABB's complete safety solutions

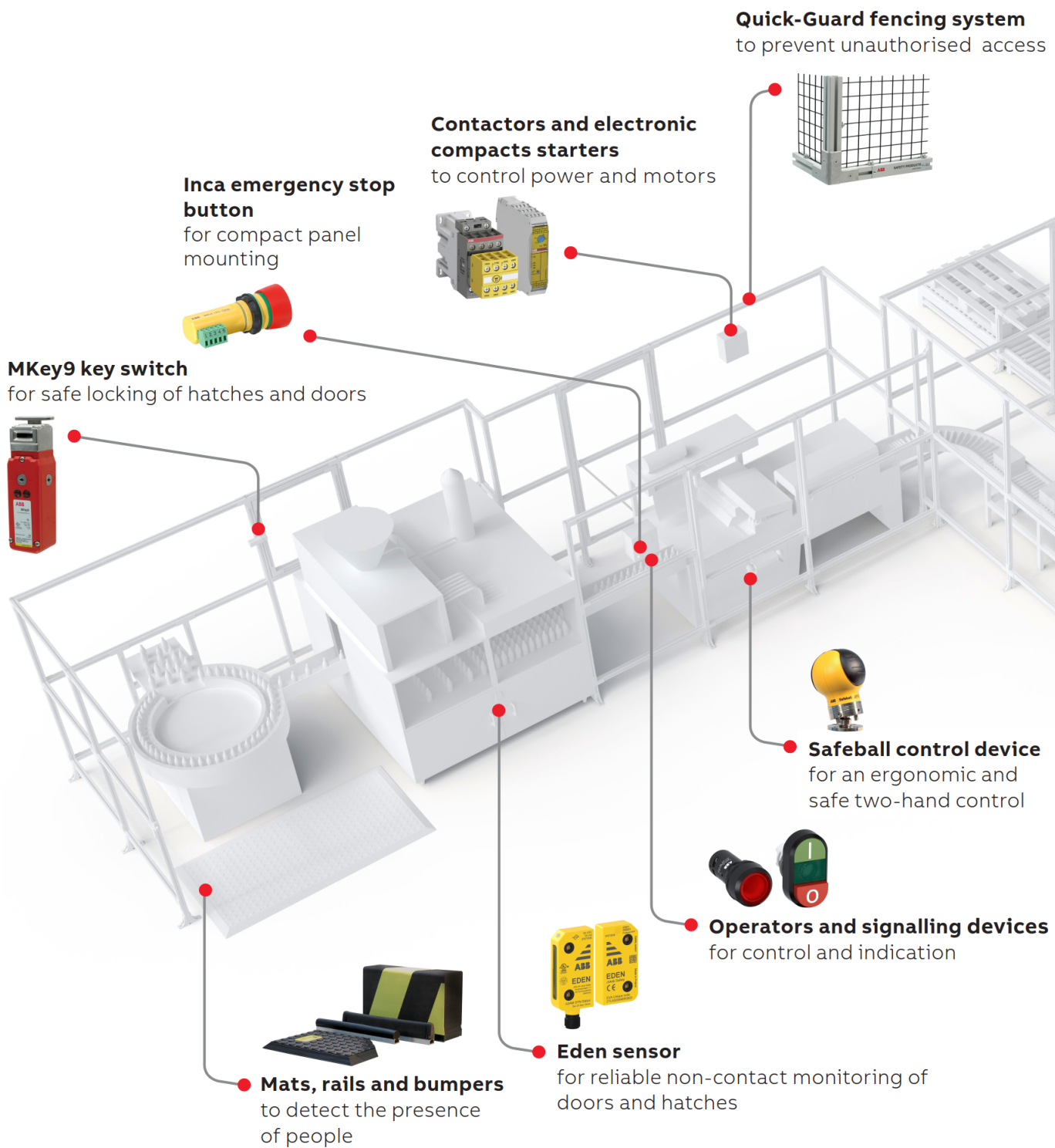

Magne magnetic lock
to keep doors and hatches
locked during a process



Pluto programmable safety controller, Vital safety controller and Sentry safety relays
for flexible monitoring of safety devices



Smile emergency stop button
to safely stop machinery in hazardous
situations



Orion light guards
for a production friendly
safety detection



Knox safety lock
for safe locking of doors



JSDH4 three-position device
for safe and ergonomic
inspection and troubleshooting



**LineStrong pull wire
emergency stop switch**
for easy access of emergency stop
function



AFS09 ... AFS38 3-pole contactors for safety applications

4 to 18.5 kW

AC / DC operated with 2 N.O. + 2 N.C. auxiliary contacts



AFS16-30-22

1SBC101536V0014



AFS38-30-22

1SBC101539V0014

AFS09 ... AFS38 contactors are designed for machine safety applications. They are delivered with fixed front-mounted auxiliary contact blocks making them ideal for monitoring and controlling circuits.

Mechanically linked and mirror contacts make your system safer.

- control circuit with electronic coil interface:
 - dedicated 24 V DC for direct control by PLC-output ≥ 250 mA, low holding consumption up to 1.7 W
 - 24...60 V AC, 20...60 V DC and 100...250 V AC / DC operated accepting a wide control voltage range
 - reduced panel energy consumption
- mirror and mechanically linked contacts, with front marked symbol acc. to IEC60947-5-1, always guaranteeing the right contactor status
- front-mounted auxiliary contact block:
 - permanently fixed
 - protective cover to prevent manual operation
 - yellow housing for easy identification
 - minimum switching capacity 12 V / 3 mA, with a failure rate 10^{-7} acc. to IEC 60947-5-4
- built-in surge suppression

| IEC | | UL/CSA | | Rated control circuit voltage | | Auxiliary contacts fitted | Type (1) | Order code | Weight |
|-------------------------|--|----------------------------|-----------------------------|-------------------------------|-----------------|---------------------------|-----------------|-----------------|----------|
| Rated operational power | operational current $\theta \leq 40^\circ\text{C}$ | 3-phase motor rating 480 V | General use rating 600 V AC | Uc min. ... Uc max. | | | | | |
| 400 V AC-3 kW | 25 A | 5 hp | 25 A | - | 24 | 2 2 | AFS09Z-30-22-30 | 1SBL136082R3022 | 0.490 kg |
| | | | | 24 ... 60 | 20 ... 60 (1) | 2 2 | AFS09-30-22-11 | 1SBL137082R1122 | 0.320 |
| | | | | 100 ... 250 | 100 ... 250 | 2 2 | AFS09-30-22-13 | 1SBL137082R1322 | 0.320 |
| 5.5 kW | 28 A | 7-1/2 hp | 28 A | - | 24 | 2 2 | AFS12Z-30-22-30 | 1SBL156082R3022 | 0.490 kg |
| | | | | 24 ... 60 | 20 ... 60 (1) | 2 2 | AFS12-30-22-11 | 1SBL157082R1122 | 0.320 |
| | | | | 100 ... 250 | 100 ... 250 | 2 2 | AFS12-30-22-13 | 1SBL157082R1322 | 0.320 |
| 7.5 kW | 30 A | 10 hp | 30 A | - | 24 | 2 2 | AFS16Z-30-22-30 | 1SBL176082R3022 | 0.490 kg |
| | | | | 24 ... 60 | 20 ... 60 (1) | 2 2 | AFS16-30-22-11 | 1SBL177082R1122 | 0.320 |
| | | | | 100 ... 250 | 100 ... 250 | 2 2 | AFS16-30-22-13 | 1SBL177082R1322 | 0.320 |
| 11 kW | 45 A | 15 hp | 45 A | - | 24 | 2 2 | AFS26Z-30-22-30 | 1SBL236082R3022 | 0.540 kg |
| | | | | 24 ... 60 | 20 ... 60 (1) | 2 2 | AFS26-30-22-11 | 1SBL237082R1122 | 0.360 |
| | | | | 100 ... 250 | 100 ... 250 | 2 2 | AFS26-30-22-13 | 1SBL237082R1322 | 0.360 |
| 15 kW | 50 A | 20 hp | 50 A | - | 24 | 2 2 | AFS30Z-30-22-30 | 1SBL276082R3022 | 0.540 kg |
| | | | | 24 ... 60 | 20 ... 60 | 2 2 | AFS30-30-22-11 | 1SBL277082R1122 | 0.360 |
| | | | | 100 ... 250 | 100 ... 250 (1) | 2 2 | AFS30-30-22-13 | 1SBL277082R1322 | 0.360 |
| 18.5 kW | 50 A | 25 hp | 50 A | - | 24 | 2 2 | AFS38Z-30-22-30 | 1SBL296082R3022 | 0.540 kg |
| | | | | 24 ... 60 | 20 ... 60 (1) | 2 2 | AFS38-30-22-11 | 1SBL297082R1122 | 0.360 |
| | | | | 100 ... 250 | 100 ... 250 | 2 2 | AFS38-30-22-13 | 1SBL297082R1322 | 0.360 |

(1) AFS...-30...-11 for control by transistor outputs of safety PLCs and safety relays use interface relay RA4 1SBN060100R1000.

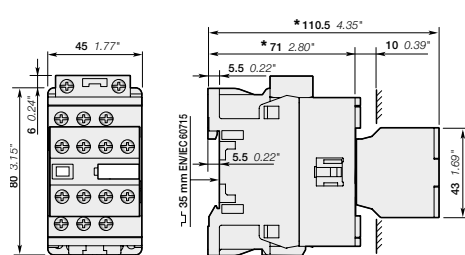

AFS09, AFS12, AFS16

* For AFS09Z, AFS12Z, AFS16Z-30-22-30: depth + 20 mm (+ 0.79")

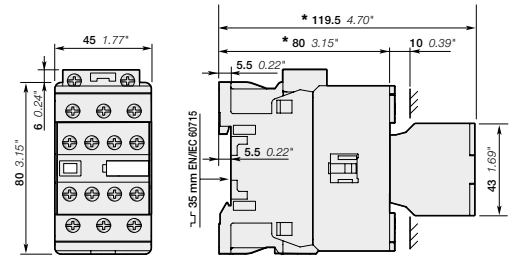

AFS26, AFS30, AFS38

* For AFS26Z, AFS30Z, AFS38Z-30-22-30: depth + 20 mm (+ 0.79")

Main dimensions mm, inches

AFS40 ... AFS96 3-pole contactors for safety applications

18.5 to 45 kW

AC / DC operated with 2 N.O. + 2 N.C. auxiliary contacts

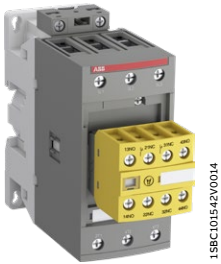

AFS65-30-22

1SBC101542V0014



AFS96-30-22

1SBC101544V0014

AFS40 ... AFS96 contactors are designed for machine safety applications. They are delivered with fixed front-mounted auxiliary contact blocks making them ideal for monitoring and controlling circuits. Mechanically linked and mirror contacts make your system safer.

- control circuit with electronic coil interface:
 - 24...60 V AC, 20...60 V DC and 100...250 V AC / DC operated accepting a wide control voltage range
 - reduced panel energy consumption
- mirror and mechanically linked contacts, with front marked symbol acc. to IEC60947-5-1, always guaranteeing the right contactor status
- front-mounted auxiliary contact block:
 - permanently fixed
 - protective cover to prevent manual operation
 - yellow housing for easy identification
 - minimum switching capacity 12 V / 3 mA, with a failure rate 10^{-7} acc. to IEC 60947-5-4
- built-in surge suppression

| IEC | | UL/CSA | | Rated control circuit voltage | | | Auxiliary contacts fitted | Type (1) | Order code | Weight |
|-------------------------|--|----------------------------|-----------------------------|-------------------------------|---------------|-----|---------------------------|-----------------|------------|--------|
| Rated operational power | current $\theta \leq 40^\circ\text{C}$ | 3-phase motor rating 480 V | General use rating 600 V AC | Uc min. ... | Uc max. | | | | | |
| 400 V AC-3 kW | AC-1 A | hp | A | V 50/60 Hz | V DC | | | | kg | |
| 18.5 | 70 | 30 | 60 | 24 ... 60 | 20 ... 60 (1) | 2 2 | AFS40-30-22-11 | 1SBL347082R1122 | 1.020 | |
| | | | | 100 ... 250 | 100 ... 250 | 2 2 | AFS40-30-22-13 | 1SBL347082R1322 | 1.000 | |
| 22 | 100 | 40 | 80 | 24 ... 60 | 20 ... 60 (1) | 2 2 | AFS52-30-22-11 | 1SBL367082R1122 | 1.020 | |
| | | | | 100 ... 250 | 100 ... 250 | 2 2 | AFS52-30-22-13 | 1SBL367082R1322 | 1.000 | |
| 30 | 105 | 50 | 90 | 24 ... 60 | 20 ... 60 (1) | 2 2 | AFS65-30-22-11 | 1SBL387082R1122 | 1.020 | |
| | | | | 100 ... 250 | 100 ... 250 | 2 2 | AFS65-30-22-13 | 1SBL387082R1322 | 1.000 | |
| 37 | 125 | 60 | 105 | 24 ... 60 | 20 ... 60 (1) | 2 2 | AFS80-30-22-11 | 1SBL397082R1122 | 1.270 | |
| | | | | 100 ... 250 | 100 ... 250 | 2 2 | AFS80-30-22-13 | 1SBL397082R1322 | 1.220 | |
| 45 | 130 | 60 | 115 | 24 ... 60 | 20 ... 60 (1) | 2 2 | AFS96-30-22-11 | 1SBL407082R1122 | 1.270 | |
| | | | | 100 ... 250 | 100 ... 250 | 2 2 | AFS96-30-22-13 | 1SBL407082R1322 | 1.220 | |

(1) AFS...-30...-11 for control by transistor outputs of safety PLCs and safety relays use interface relay RA4 1SBN060100R1000.

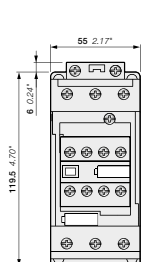

AFS40, AFS52, AFS65

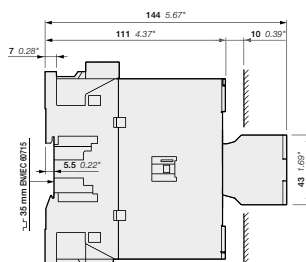

AFS80, AFS96

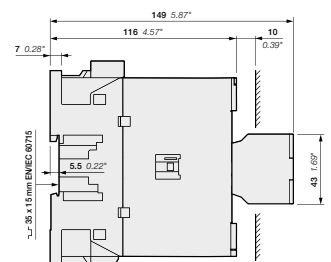

Main dimensions mm, inches

1SBC10030950201

AFS09 ... AFS96 3-pole contactors for safety applications

Contactors and main accessories

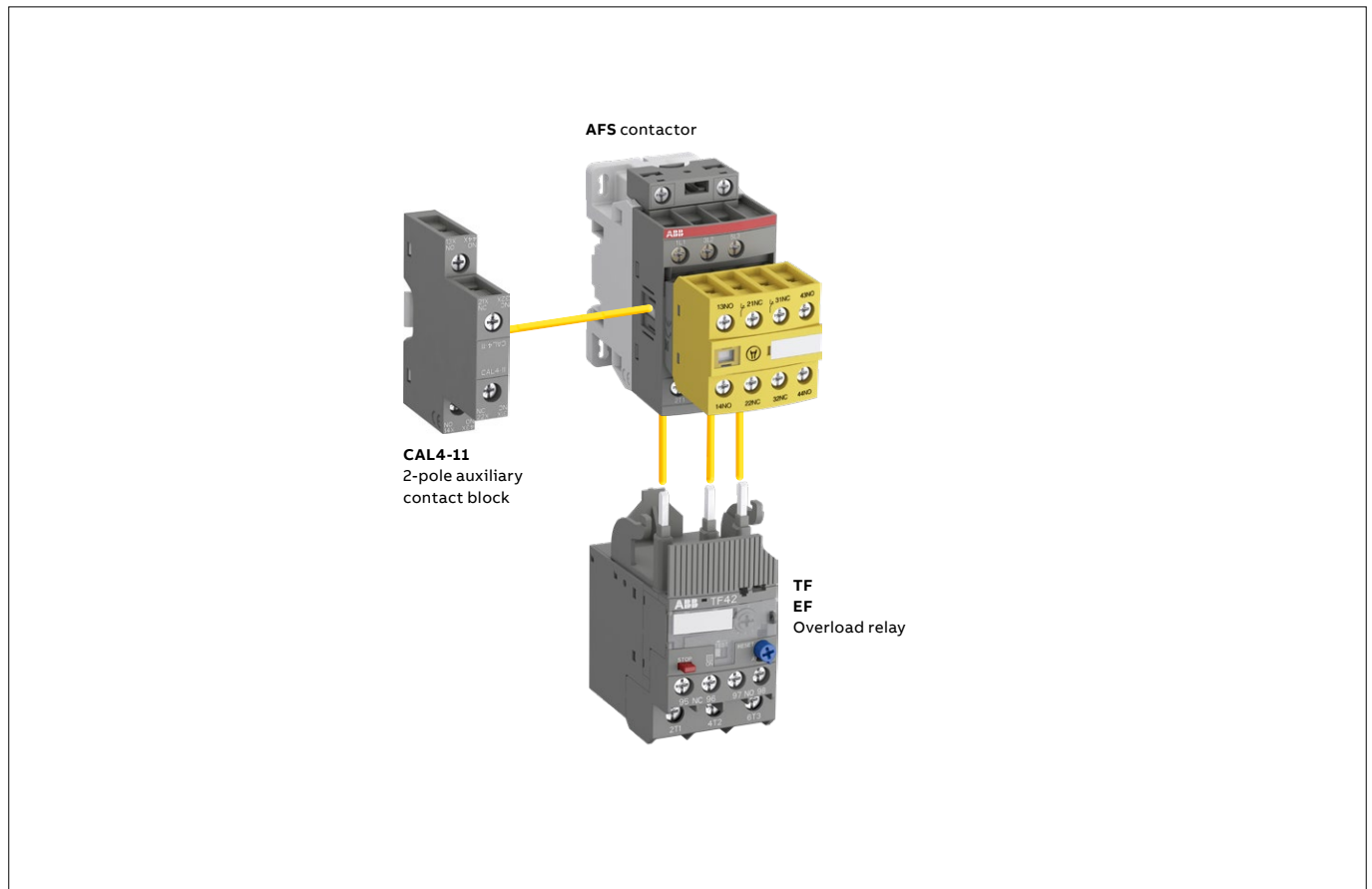

Main accessory fitting details - for ordering details, technical data and other accessories: see section accessories
Many configurations of accessories are possible depending on whether these are front-mounted or side-mounted.

| Contactor types | Main poles | Built-in auxiliary contacts | Front-mounted accessories | | | | Mechanical interlock unit (between 2 contactors) | Side-mounted accessories | |
|-------------------|------------|-----------------------------|---------------------------|----------------|------------|------------------|--|-----------------------------|------------|
| | | | Auxiliary contact blocks | | | Electronic timer | | Auxiliary contact blocks | |
| | | | 1-pole CA4 | 2-pole CAT4-11 | 4-pole CA4 | TEF4 | VM.. | 2-pole CAL4-11 Left side | Right side |
| AFS09 ... AFS38 | 3 0 | 2 2 | - | - | - | - | 1 | + 1 | - |
| AFS09Z ... AFS38Z | 3 0 | 2 2 | - | - | - | - | 1 | - | - |
| AFS40 ... AFS96 | 3 0 | 2 2 | - | - | - | - | - | + 1 | + 1 |
| | | | - | - | - | - | - | + 1 | or 1 |

Overload relays fitting details (1)

| Contactor types | Thermal overload relays | Electronic overload relays |
|-----------------|-------------------------|----------------------------|
| AFS09 ... AFS38 | TF42 (0.10...38 A) | EF19 (0.10...19 A) |
| AFS26 ... AFS38 | TF42 (0.10...38 A) | EF45 (9...45 A) |
| AFS40 ... AFS65 | TF65 (22...67 A) | EF65 (20...70 A) |
| AFS80, AFS96 | TF96 (40...96 A) | EF96 (36...100 A) |

The addition of an overload relay on the contactor does not prevent fitting of many other accessories as shown above.

(1) Direct mounting - No kit required.

AFS09 ... AFS96 3-pole contactors for safety applications

Main accessories



CAL4-11

1SBCL0007V0014

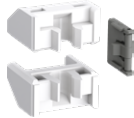

VM4

1SBCL00010V0014

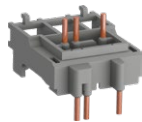

BEA16-4

1SBCL00034V0014

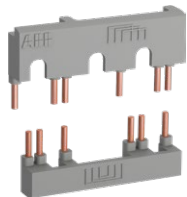

BER16-4

1SBCL00016V0014

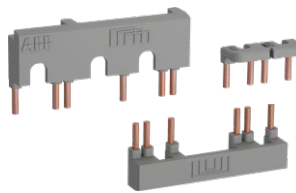

BEY16-4

1SBCL00018V0014

| For contactors | Auxiliary contacts | Type | Order code | Pkg qty | Weight (1 pce) |
|----------------|--------------------|------|------------|---------|----------------|
| | | | | | kg |

Side-mounted instantaneous auxiliary contact blocks

| | | | | | | |
|-----------------|-----|-----|-----------|-----------------|----|-------|
| AFS09 ... AFS96 | 1 1 | - - | CAL4-11 | 1SBN010120R1011 | 1 | 0.040 |
| | 1 1 | - - | CAL4-11-T | 1SBN010120T1011 | 10 | 0.040 |

Mechanical interlock unit

| | | | | | |
|-----------------|--|--------|-----------------|----|-------|
| AFS09 ... AFS38 | | VM4 | 1SBN030105T1000 | 10 | 0.005 |
| AFS40 ... AFS96 | | VM96-4 | 1SBN033405T1000 | 10 | 0.006 |

Note: VM4 and VM96-4 include 2 fixing clips (BB4) to maintain together both contactors.

| For contactors | Type | Order code | Pkg qty | Weight (1 pce) |
|----------------|------|------------|---------|----------------|
| | | | | kg |

Connecting links with manual motor starters

| | | | | | |
|-----------------|---|---------|-----------------|----|-------|
| AFS09 ... AFS16 | with MS116-0.16 ... MS116-25, MS132-0.16 ... MS132-25 | BEA16-4 | 1SBN081306T1000 | 10 | 0.025 |
| AFS26 ... AFS38 | with MS116-0.16 ... MS116-16, MS132-0.16 ... MS132-10 | BEA26-4 | 1SBN082306T1000 | 10 | 0.025 |
| | with MS116-20 ... MS116-32, MS132-12 ... MS132-32 | BEA38-4 | 1SBN082306T2000 | 10 | 0.030 |
| AFS40 ... AFS65 | with MS165-16 ... MS165-65 | BEA65-4 | 1SBN083406R1000 | 1 | 0.090 |
| | with MS165-16 ... MS165-65 (2) | BPR65-4 | 1SBN113405R1000 | 1 | 0.014 |

Connection sets for reversing contactors

| | | | | |
|-----------------|---------|-----------------|---|-------|
| AFS09 ... AFS16 | BER16-4 | 1SBN081311R1000 | 1 | 0.045 |
| AFS26 ... AFS38 | BER38-4 | 1SBN082311R1000 | 1 | 0.100 |
| AFS40 ... AFS65 | BER65-4 | 1SBN083411R1000 | 1 | 0.175 |
| AFS80 ... AFS96 | BER96-4 | 1SBN083911R1000 | 1 | 0.250 |

Connection sets for star-delta starting

| | | | | | |
|-----------------|------------------------|---------|-----------------|---|-------|
| AFS09 ... AFS16 | with or without VM4 | BEY16-4 | 1SBN081313R2000 | 1 | 0.050 |
| AFS26 ... AFS38 | with or without VM4 | BEY38-4 | 1SBN082713R2000 | 1 | 0.110 |
| AFS40 ... AFS65 | with or without VM96-4 | BEY65-4 | 1SBN083413R2000 | 1 | 0.200 |
| AFS80 ... AFS96 | with or without VM96-4 | BEY96-4 | 1SBN083913R2000 | 1 | 0.250 |

(1) For more information, refer to "Accessories" section.
 (2) Use one BPR65-4 for each contactor AFS40 ... AF565.

AFS116 ... AFS146 3-pole contactors for safety applications

55 to 75 kW

AC / DC operated with 1 N.O. + 2 N.C. auxiliary contacts

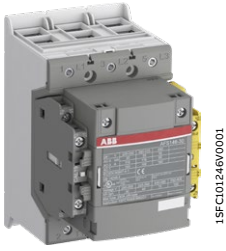

AFS146-30-12

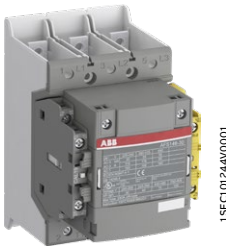

AFS146-30-12B

AFS116 ... AFS146 contactors are designed for machine safety applications. They are delivered with fixed 1 left (1 N.O + 1 N.C.) and 1 right (1 N.C.) side mounted auxiliary contact blocks making them ideal for monitoring and controlling circuits.

Mechanically linked contacts make your system safer.

- control circuit: AC or DC operated with electronic coil interface accepting a wide control voltage range (e.g. 100...250 V AC and DC), only 4 coils to cover control voltages between 24...500 V 50/60 Hz and 20...500 V DC
 - can manage large control voltage variations
 - reduced panel energy consumption
- mirror and mechanically linked contacts, with front marked symbol acc. to IEC60947-5-1, always guaranteeing the right contactor status
- side-mounted auxiliary contact blocks:
 - permanently fixed
 - yellow housing for easy identification
 - minimum switching capacity 12 V / 3 mA, with a failure rate 10⁻⁷ acc. to IEC 60947-5-4
- built-in surge suppression

| IEC | | UL / CSA | | Rated control circuit voltage Uc min. Uc max. | Auxiliary contacts fitted | Type | Order code | Weight Pkg (1 pce) kg |
|-------------------------|----------------------|----------------------|--------------------|---|---------------------------|------|------------|-----------------------------|
| Rated operational power | current θ ≤ 40 °C | 3-phase motor rating | General use rating | | | | | |
| 400 V | AC-3 | AC-1 | hp | A | V 50/60 Hz V DC | | | |
| kW | A | hp | A | | | | | |

For connection with built-in cable clamps

| 55 | 160 | 75 | 160 | 24...60 | 20...60 | 1 2 | AFS116-30-12-11 | 1SFL427081R1112 | 1.750 |
|----|-----|-----|-----|-----------|-----------|-----|-----------------|-----------------|-------|
| | | | | 48...130 | 48...130 | 1 2 | AFS116-30-12-12 | 1SFL427081R1212 | 1.750 |
| | | | | 100...250 | 100...250 | 1 2 | AFS116-30-12-13 | 1SFL427081R1312 | 1.750 |
| | | | | 250...500 | 250...500 | 1 2 | AFS116-30-12-14 | 1SFL427081R1412 | 1.750 |
| 75 | 225 | 100 | 200 | 24...60 | 20...60 | 1 2 | AFS146-30-12-11 | 1SFL467081R1112 | 1.750 |
| | | | | 48...130 | 48...130 | 1 2 | AFS146-30-12-12 | 1SFL467081R1212 | 1.750 |
| | | | | 100...250 | 100...250 | 1 2 | AFS146-30-12-13 | 1SFL467081R1312 | 1.750 |
| | | | | 250...500 | 250...500 | 1 2 | AFS146-30-12-14 | 1SFL467081R1412 | 1.750 |

With bar connections

| 55 | 160 | 75 | 160 | 24...60 | 20...60 | 1 2 | AFS116-30-12B-11 | 1SFL427082R1112 | 1.500 |
|----|-----|-----|-----|-----------|-----------|-----|------------------|-----------------|-------|
| | | | | 48...130 | 48...130 | 1 2 | AFS116-30-12B-12 | 1SFL427082R1212 | 1.500 |
| | | | | 100...250 | 100...250 | 1 2 | AFS116-30-12B-13 | 1SFL427082R1312 | 1.500 |
| | | | | 250...500 | 250...500 | 1 2 | AFS116-30-12B-14 | 1SFL427082R1412 | 1.500 |
| 75 | 225 | 100 | 200 | 24...60 | 20...60 | 1 2 | AFS146-30-12B-11 | 1SFL467082R1112 | 1.500 |
| | | | | 48...130 | 48...130 | 1 2 | AFS146-30-12B-12 | 1SFL467082R1212 | 1.500 |
| | | | | 100...250 | 100...250 | 1 2 | AFS146-30-12B-13 | 1SFL467082R1312 | 1.500 |
| | | | | 250...500 | 250...500 | 1 2 | AFS146-30-12B-14 | 1SFL467082R1412 | 1.500 |

(1) For other auxiliary contacts arrangements, please contact your ABB local sales organization.

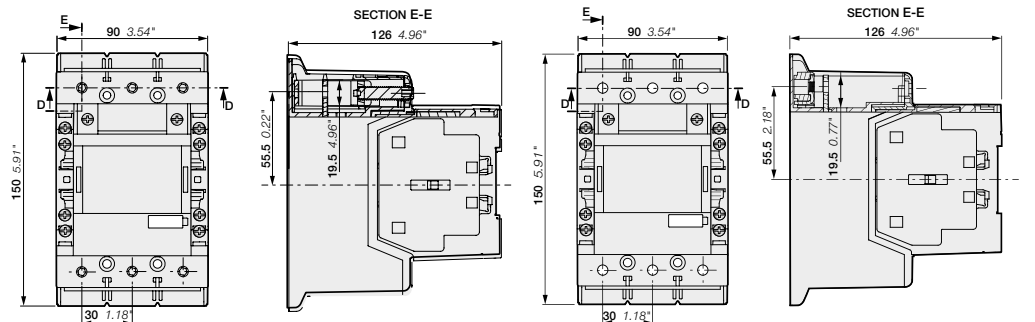

AFS116, AFS146-30-12

AFS116, AFS146-30-12B

Main dimensions mm, inches

AFS116 ... AFS146 3-pole contactors for safety applications with built-in PLC interface - 55 to 75 kW

AC / DC operated with 1 N.O. + 2 N.C. auxiliary contacts

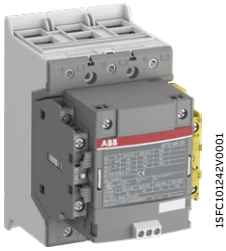

AFS146-30-12

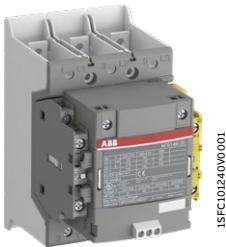

AFS146-30-12B

AFS116 ... AFS146 contactors are designed for machine safety applications. They are delivered with fixed 1 left (1 N.O + 1 N.C.) and 1 right (1 N.C.) side mounted auxiliary contact blocks making them ideal for monitoring and controlling circuits.

Mechanically linked contacts make your system safer.

- control circuit: AC or DC operated with electronic coil interface accepting a wide control voltage range (e.g. 100...250 V AC and DC), only 2 coils to cover control voltages between 100...500 V 50/60 Hz and 100...500 V DC
 - can manage large control voltage variations
 - reduced panel energy consumption
- mirror and mechanically linked contacts, with front marked symbol acc. to IEC60947-5-1, always guaranteeing the right contactor status
- side-mounted auxiliary contact blocks:
 - permanently fixed
 - yellow housing for easy identification
 - minimum switching capacity 12 V / 3 mA, with a failure rate 10^{-7} acc. to IEC 60947-5-4
- built-in surge suppression

| IEC | | UL / CSA | | Rated control circuit voltage Uc min. ... Uc max. | Auxiliary contacts fitted | Type | Order code | Weight Pkg (1 pce) kg |
|-------------------------|---|----------------------|--------------------|--|---------------------------|------|------------|-----------------------------|
| Rated operational power | current $\theta \leq 40^\circ\text{C}$ | 3-phase motor rating | General use rating | | | | | |
| 400 V | | 480 V | 600 V AC | V 50/60 Hz V DC | | | | |
| AC-3 | AC-1 | | | | | | | |
| kW | A | hp | A | | | | | |

For connection with built-in cable clamps

| Rated power (kW) | Rated current (A) | Motor rating (hp) | General use rating (A) | Uc min (V) | Uc max (V) | Contacts | Type | Order code | Weight (kg) |
|------------------|-------------------|-------------------|------------------------|------------|------------|----------|-----------------|-----------------|-------------|
| 55 | 160 | 75 | 160 | 100...250 | 100...250 | 1 2 | AFS116-30-12-33 | 1SFL427081R3312 | 1.750 |
| | | | | 250...500 | 250...500 | 1 2 | AFS116-30-12-34 | 1SFL427081R3412 | 1.750 |
| 75 | 225 | 100 | 200 | 100...250 | 100...250 | 1 2 | AFS146-30-12-33 | 1SFL467081R3312 | 1.750 |
| | | | | 250...500 | 250...500 | 1 2 | AFS146-30-12-34 | 1SFL467081R3412 | 1.750 |

With bar connections

| Rated power (kW) | Rated current (A) | Motor rating (hp) | General use rating (A) | Uc min (V) | Uc max (V) | Contacts | Type | Order code | Weight (kg) |
|------------------|-------------------|-------------------|------------------------|------------|------------|----------|------------------|-----------------|-------------|
| 55 | 160 | 75 | 160 | 100...250 | 100...250 | 1 2 | AFS116-30-12B-33 | 1SFL427082R3312 | 1.500 |
| | | | | 250...500 | 250...500 | 1 2 | AFS116-30-12B-34 | 1SFL427082R3412 | 1.500 |
| 75 | 225 | 100 | 200 | 100...250 | 100...250 | 1 2 | AFS146-30-12B-33 | 1SFL467082R3312 | 1.500 |
| | | | | 250...500 | 250...500 | 1 2 | AFS146-30-12B-34 | 1SFL467082R3412 | 1.500 |

(1) For other auxiliary contacts arrangements, please contact your ABB local sales organization.

AFS116 ... AFS146 are equipped with low voltage inputs for control, for example by a PLC.

Control inputs

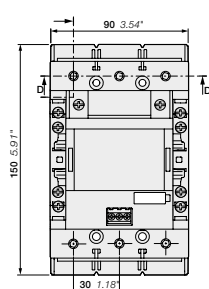
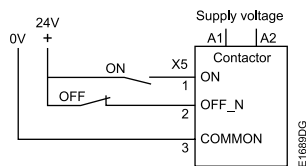

AFS116, AFS146-30-12

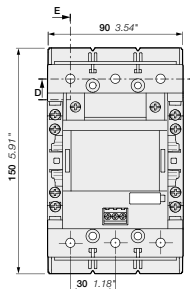
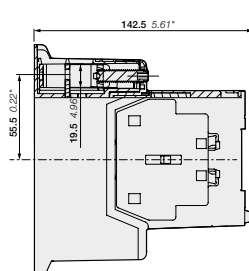

AFS116, AFS146-30-12B

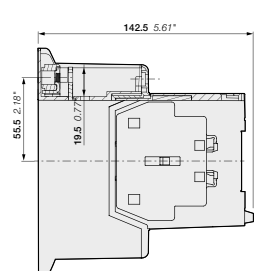

Main dimensions mm, inches

AFS190 ... AFS370 3-pole contactors for safety applications 90 to 200 kW

AC / DC operated with 1 N.O. + 2 N.C. auxiliary contacts

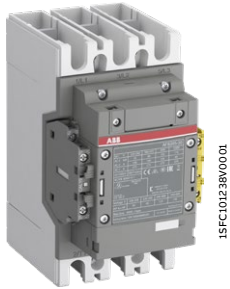

AFS205-30-12

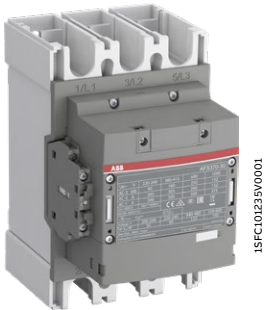

AFS370-30-12

AFS190 ... AFS370 contactors are designed for machine safety applications. They are delivered with fixed 1 left (1 N.O + 1 N.C.) and 1 right (1 N.C.) side mounted auxiliary contact blocks making them ideal for monitoring and controlling circuits.

Mechanically linked contacts make your system safer.

- control circuit: AC or DC operated with electronic coil interface accepting a wide control voltage range (e.g. 100...250 V AC and DC), only 4 coils to cover control voltages between 24...500 V 50/60 Hz and 20...500 V DC
 - can manage large control voltage variations
 - reduced panel energy consumption
- mirror and mechanically linked contacts, with front marked symbol acc. to IEC60947-5-1, always guaranteeing the right contactor status
- side-mounted auxiliary contact blocks:
 - permanently fixed
 - yellow housing for easy identification
 - minimum switching capacity 12 V / 3 mA, with a failure rate 10⁻⁷ acc. to IEC 60947-5-4
- built-in surge suppression

| IEC | | UL / CSA | | Rated control circuit voltage | | Auxiliary contacts fitted | Type | Order code | Weight |
|-------------------------|---|----------------------|--------------------|-------------------------------|-----------|---------------------------|-----------------|-----------------|--------|
| Rated operational power | current $\theta \leq 40^\circ\text{C}$ | 3-phase motor rating | General use rating | Uc min. ... Uc max. | | | | | |
| 400 V AC-3 kW | AC-1 A | hp | A | V 50/60 Hz | V DC | | | kg | |
| 90 | 275 | 125 | 250 | 24...60 | 20...60 | 1 2 | AFS190-30-12-11 | 1SFL487082R1112 | 3.000 |
| | | | | 48...130 | 48...130 | 1 2 | AFS190-30-12-12 | 1SFL487082R1212 | 3.000 |
| | | | | 100...250 | 100...250 | 1 2 | AFS190-30-12-13 | 1SFL487082R1312 | 3.000 |
| | | | | 250...500 | 250...500 | 1 2 | AFS190-30-12-14 | 1SFL487082R1412 | 3.000 |
| 110 | 350 | 150 | 300 | 24...60 | 20...60 | 1 2 | AFS205-30-12-11 | 1SFL527082R1112 | 3.000 |
| | | | | 48...130 | 48...130 | 1 2 | AFS205-30-12-12 | 1SFL527082R1212 | 3.000 |
| | | | | 100...250 | 100...250 | 1 2 | AFS205-30-12-13 | 1SFL527082R1312 | 3.000 |
| | | | | 250...500 | 250...500 | 1 2 | AFS205-30-12-14 | 1SFL527082R1412 | 3.000 |
| 132 | 400 | 200 | 350 | 24...60 | 20...60 | 1 2 | AFS265-30-12-11 | 1SFL547082R1112 | 4.675 |
| | | | | 48...130 | 48...130 | 1 2 | AFS265-30-12-12 | 1SFL547082R1212 | 4.675 |
| | | | | 100...250 | 100...250 | 1 2 | AFS265-30-12-13 | 1SFL547082R1312 | 4.675 |
| | | | | 250...500 | 250...500 | 1 2 | AFS265-30-12-14 | 1SFL547082R1412 | 4.675 |
| 160 | 500 | 250 | 400 | 24...60 | 20...60 | 1 2 | AFS305-30-12-11 | 1SFL587082R1112 | 4.675 |
| | | | | 48...130 | 48...130 | 1 2 | AFS305-30-12-12 | 1SFL587082R1212 | 4.675 |
| | | | | 100...250 | 100...250 | 1 2 | AFS305-30-12-13 | 1SFL587082R1312 | 4.675 |
| | | | | 250...500 | 250...500 | 1 2 | AFS305-30-12-14 | 1SFL587082R1412 | 4.675 |
| 200 | 600 | 300 | 520 | 24...60 | 20...60 | 1 2 | AFS370-30-12-11 | 1SFL607082R1112 | 4.675 |
| | | | | 48...130 | 48...130 | 1 2 | AFS370-30-12-12 | 1SFL607082R1212 | 4.675 |
| | | | | 100...250 | 100...250 | 1 2 | AFS370-30-12-13 | 1SFL607082R1312 | 4.675 |
| | | | | 250...500 | 250...500 | 1 2 | AFS370-30-12-14 | 1SFL607082R1412 | 4.675 |

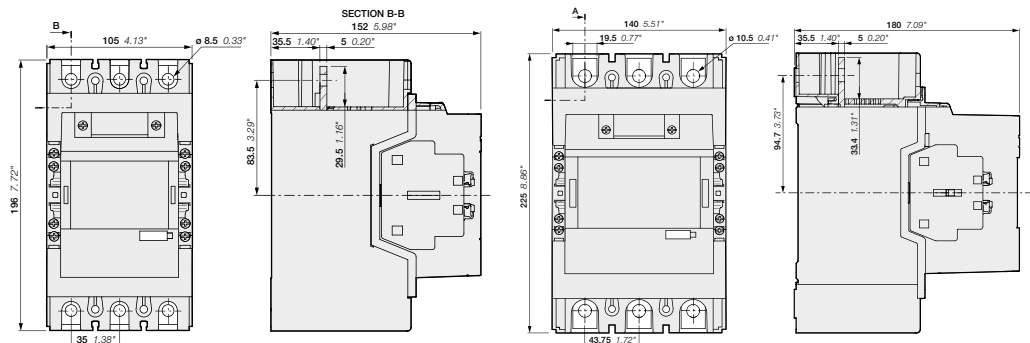

AFS190, AFS205

AFS265, AFS305, AFS370

Main dimensions mm, inches

AFS190 ... AFS370 3-pole contactors for safety applications with built-in PLC interface - 90 to 200 kW

AC / DC operated with 1 N.O. + 2 N.C. auxiliary contacts

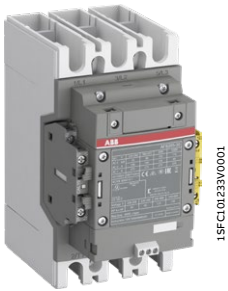

AFS205-30-12

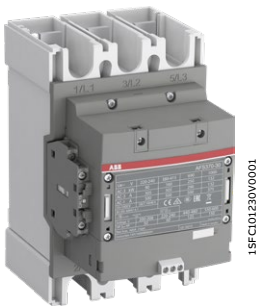

AFS370-30-12

AFS190 ... AFS370 contactors are designed for machine safety applications. They are delivered with fixed 1 left (1 N.O + 1 N.C.) and 1 right (1 N.C.) side mounted auxiliary contact blocks making them ideal for monitoring and controlling circuits. Mechanically linked contacts make your system safer.

- control circuit: AC or DC operated with electronic coil interface accepting a wide control voltage range (e.g. 100...250 V AC and DC), only 2 coils to cover control voltages between 100...500 V 50/60 Hz and 100...500 V DC
 - can manage large control voltage variations
 - reduced panel energy consumption
- mirror and mechanically linked contacts, with front marked symbol acc. to IEC60947-5-1, always guaranteeing the right contactor status
- side-mounted auxiliary contact blocks:
 - permanently fixed
 - yellow housing for easy identification
 - minimum switching capacity 12 V / 3 mA, with a failure rate 10^{-7} acc. to IEC 60947-5-4
- built-in surge suppression

| IEC | | UL / CSA | | Rated control circuit voltage | | Auxiliary contacts fitted | Type (1) | Order code | Weight |
|-------------------------|--|----------------------|--------------------|-------------------------------|------------|---------------------------|-----------------|-----------------|-------------|
| Rated operational power | current $\theta \leq 40^\circ\text{C}$ | 3-phase motor rating | General use rating | Uc min. ... Uc max. | | | | | |
| 400 V | AC-3 | AC-1 | 480 V | 600 V AC | V 50/60 Hz | V DC | | | Pkg (1 pce) |
| kW | A | hp | A | | | | | | kg |
| 90 | 275 | 125 | 250 | 100...250 | 100...250 | 1 2 | AFS190-30-12-33 | 1SFL487082R3312 | 3.000 |
| | | | | 250...500 | 250...500 | 1 2 | AFS190-30-12-34 | 1SFL487082R3412 | 3.000 |
| 110 | 350 | 150 | 300 | 100...250 | 100...250 | 1 2 | AFS205-30-12-33 | 1SFL527082R3312 | 3.000 |
| | | | | 250...500 | 250...500 | 1 2 | AFS205-30-12-34 | 1SFL527082R3412 | 3.000 |
| 132 | 400 | 200 | 350 | 100...250 | 100...250 | 1 2 | AFS265-30-12-33 | 1SFL547082R3312 | 4.675 |
| | | | | 250...500 | 250...500 | 1 2 | AFS265-30-12-34 | 1SFL547082R3412 | 4.675 |
| 160 | 500 | 250 | 400 | 100...250 | 100...250 | 1 2 | AFS305-30-12-33 | 1SFL587082R3312 | 4.675 |
| | | | | 250...500 | 250...500 | 1 2 | AFS305-30-12-34 | 1SFL587082R3412 | 4.675 |
| 200 | 600 | 300 | 520 | 100...250 | 100...250 | 1 2 | AFS370-30-12-33 | 1SFL607082R3312 | 4.675 |
| | | | | 250...500 | 250...500 | 1 2 | AFS370-30-12-34 | 1SFL607082R3412 | 4.675 |

AFS190 ... AFS370 are equipped with low voltage inputs for control, for example by a PLC.

Control inputs

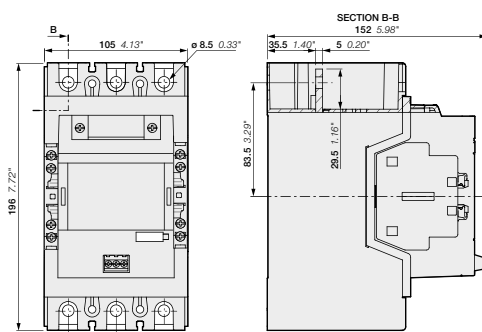
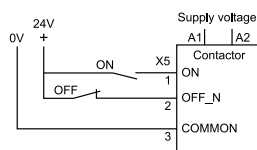

AFS190, AFS205

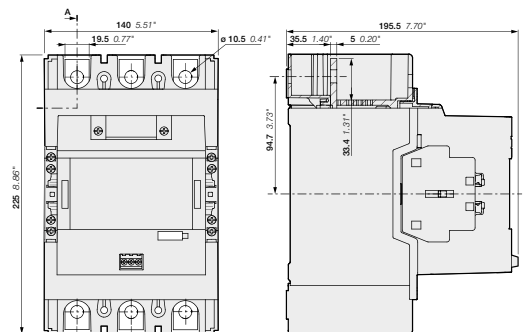

AFS265, AFS305, AFS370

Main dimensions mm, inches

AFS116 ... AFS370 3-pole contactors for safety applications with 1 N.O. + 2 N.C. auxiliary contacts

Contactors and main accessories

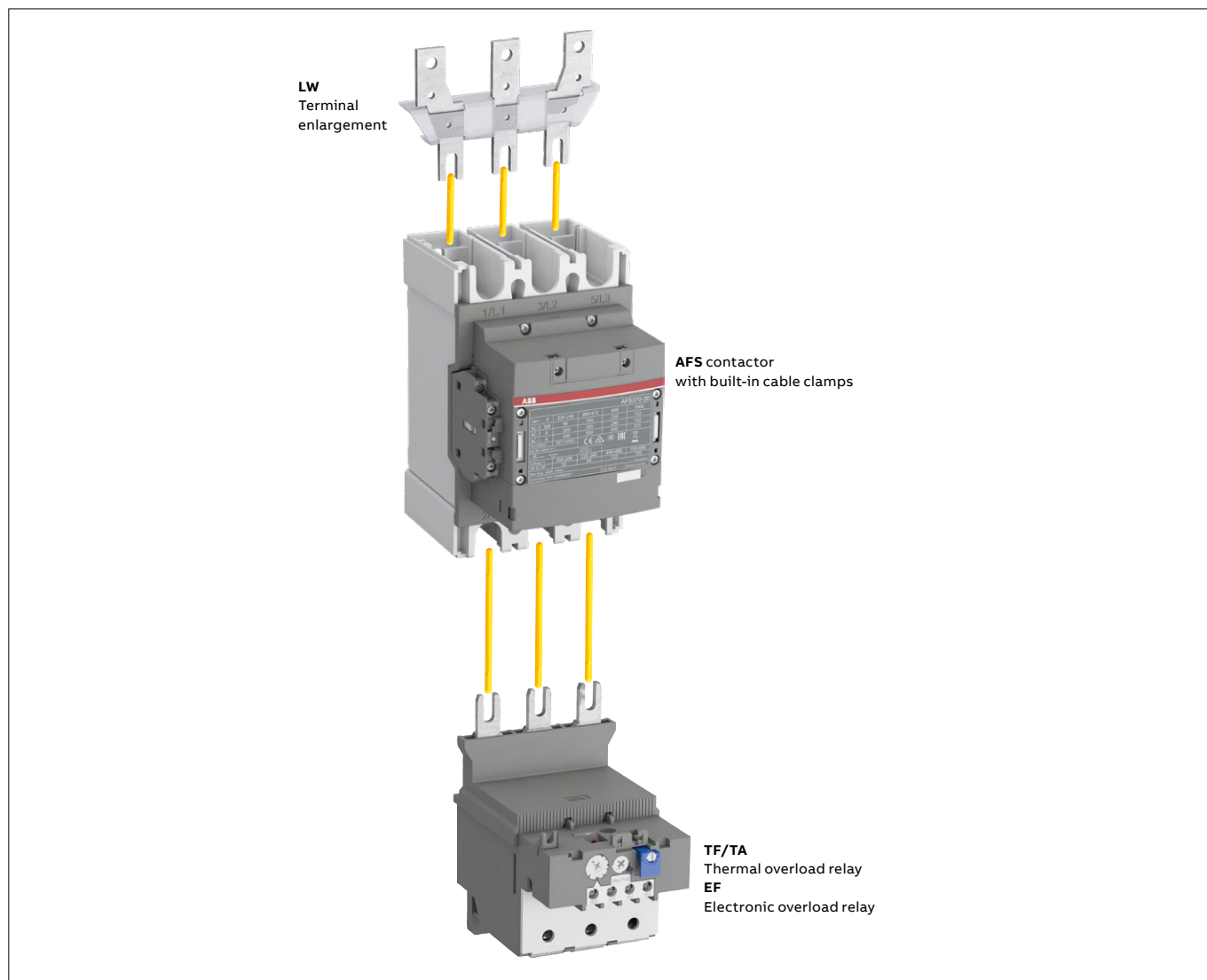

Main accessory fitting details - for ordering details, technical data and other accessories: see section accessories

Overload relays fitting details (1)

| Contactor types | Thermal overload relays | Electronic overload relays |
|-------------------|-------------------------|----------------------------|
| AFS116 | TF140DU (66...142 A) | EF146 (54...150 A) |
| AFS146 | - | EF146 (54...150 A) |
| AFS190, AFS205 | TA200DU (66...200 A) | EF205 (63...210 A) |
| AFS265 ... AFS370 | - | EF370 (115...380 A) |

The addition of a thermal or electronic overload relay on the contactor does not prevent fitting of many other accessories as shown in "Main accessory fitting details" table.

(1) Direct mounting - No kit required.

AFS116 ... AFS370 3-pole contactors for safety applications with 1 N.O. + 2 N.C. auxiliary contacts

Main accessories



| For contactors | Type | Order code | Pkg qty | Weight (1 pce) |
|----------------|------|------------|---------|----------------|
| | | | | kg |

Terminal shrouds

| | | | | |
|---|-----------|-----------------|---|-------|
| AFS116 ... AFS146, with compression lugs | LT140-30L | 1SFN124203R1000 | 2 | 0.070 |
| AFS190, AFS205, with cable clamps | LT205-30C | 1SFN124801R1000 | 2 | 0.050 |
| AFS190, AFS205, with compression lugs | LT205-30L | 1SFN124803R1000 | 2 | 0.220 |
| AFS190, AFS205, with shorting bar or between contactor and TOL/EOL in DOL-starters | LT205-30Y | 1SFN124804R1000 | 1 | 0.050 |
| AFS265 ... AFS370, with cable clamps | LT370-30C | 1SFN125401R1000 | 2 | 0.035 |
| AFS265 ... AFS370, with compression lugs | LT370-30L | 1SFN125403R1000 | 2 | 0.280 |
| AFS265 ... AFS370, with shorting bar or between contactor and TOL/EOL in DOL-starters | LT370-30Y | 1SFN125404R1000 | 1 | 0.075 |
| AFS265 ... AFS370, for use with extending cable clamps, ATK300/2 and OZXB4 | LT370-30D | 1SFN125406R1000 | 1 | 0.150 |

| For contactors | Dimensions | | Type | Order code | Pkg qty | Weight (1 pce) |
|----------------|------------|--------|------|------------|---------|----------------|
| | hole Ø mm | bar mm | | | | |
| | | | | | | kg |

Terminal enlargements

| | | | | | | |
|-----------------|------|----------|-------|-----------------|---|-------|
| AFS116...AFS146 | 6.5 | 13 x 3 | LW140 | 1SFN074207R1000 | 1 | 0.115 |
| AFS190...AFS205 | 10.5 | 17.5 x 5 | LW205 | 1SFN074807R1000 | 1 | 0.260 |
| AFS265...AFS370 | 10.5 | 20 x 5 | LW370 | 1SFN075407R1000 | 1 | 0.340 |

Terminal extension

| | | | | | | |
|-----------------|------|----------|-------|-----------------|---|-------|
| AFS116...AFS146 | 6.5 | 13 x 3 | LX140 | 1SFN074210R1000 | 1 | 0.072 |
| AFS190...AFS250 | 8.5 | 17.5 x 5 | LX205 | 1SFN074810R1000 | 1 | 0.180 |
| AFS265...AFS370 | 10.5 | 20 x 5 | LX370 | 1SFN075410R1000 | 1 | 0.234 |

(1) For more information, refer to "Accessories" section.

AFS400 ... AFS750 3-pole contactors for safety applications 200 to 400 kW

AC / DC operated with 1 N.O. + 2 N.C. auxiliary contacts



AFS460-30-12



AFS750-30-12

AFS400 ... AFS750 contactors are designed for machine safety applications. They are delivered with fixed 1 left (1 N.O + 1 N.C.) and 1 right (1 N.C.) side mounted auxiliary contact blocks making them ideal for monitoring and controlling circuits.

Mechanically linked contacts make your system safer.

- control circuit: AC or DC operated with electronic coil interface accepting a wide control voltage range (e.g. 100...250 V AC and DC), only 4 coils to cover control voltages between 24...500 V 50/60 Hz and 20...500 V DC
 - can manage large control voltage variations
 - reduced panel energy consumption
- mirror and mechanically linked contacts, with front marked symbol acc. to IEC60947-5-1, always guaranteeing the right contactor status
- side-mounted auxiliary contact blocks:
 - permanently fixed
 - yellow housing for easy identification
 - minimum switching capacity 12 V / 3 mA, with a failure rate 10^{-7} acc. to IEC 60947-5-4
- built-in surge suppression

| IEC Rated operational power 400 V AC-3 | UL/CSA 3-phase motor rating 690 V AC-1 | | General use rating 600 V AC | Rated control circuit voltage U _c | | Auxiliary contacts fitted | Type | Order code | Weight Pkg (1 pce) kg |
|---|---|-----|--------------------------------|--|-----------|---------------------------|-----------------|---------------------|-----------------------------|
| | kW | A | | hp | A | | | | |
| 200 | 600 | 350 | 550 | - | 24...60 | 1 2 | AFS400-30-12-68 | 1SFL577081R6812 (1) | 12.000 |
| | | | | 48...130 | 48...130 | 1 2 | AFS400-30-12-69 | 1SFL577081R6912 | 12.000 |
| | | | | 100...250 | 100...250 | 1 2 | AFS400-30-12-70 | 1SFL577081R7012 | 12.000 |
| | | | | 250...500 | 250...500 | 1 2 | AFS400-30-12-71 | 1SFL577081R7112 | 12.000 |
| 250 | 700 | 400 | 650 | - | 24...60 | 1 2 | AFS460-30-12-68 | 1SFL597081R6812 (1) | 12.000 |
| | | | | 48...130 | 48...130 | 1 2 | AFS460-30-12-69 | 1SFL597081R6912 | 12.000 |
| | | | | 100...250 | 100...250 | 1 2 | AFS460-30-12-70 | 1SFL597081R7012 | 12.000 |
| | | | | 250...500 | 250...500 | 1 2 | AFS460-30-12-71 | 1SFL597081R7112 | 12.000 |
| 315 | 800 | 500 | 750 | - | 24...60 | 1 2 | AFS580-30-12-68 | 1SFL617081R6812 (1) | 15.000 |
| | | | | 48...130 | 48...130 | 1 2 | AFS580-30-12-69 | 1SFL617081R6912 | 15.000 |
| | | | | 100...250 | 100...250 | 1 2 | AFS580-30-12-70 | 1SFL617081R7012 | 15.000 |
| | | | | 250...500 | 250...500 | 1 2 | AFS580-30-12-71 | 1SFL617081R7112 | 15.000 |
| 400 | 1050 | 600 | 900 | - | 24...60 | 1 2 | AFS750-30-12-68 | 1SFL637081R6812 (1) | 15.000 |
| | | | | 48...130 | 48...130 | 1 2 | AFS750-30-12-69 | 1SFL637081R6912 | 15.000 |
| | | | | 100...250 | 100...250 | 1 2 | AFS750-30-12-70 | 1SFL637081R7012 | 15.000 |
| | | | | 250...500 | 250...500 | 1 2 | AFS750-30-12-71 | 1SFL637081R7112 | 15.000 |

(1) The connection polarities indicated close to the coil terminals must be respected: A1 for the positive pole and A2 for the negative pole.

(2) Up to 850 V DC for AFS580, AFS750.

AFS400...AFS750 are equipped with low voltage inputs for control, for example by a PLC.

Control inputs

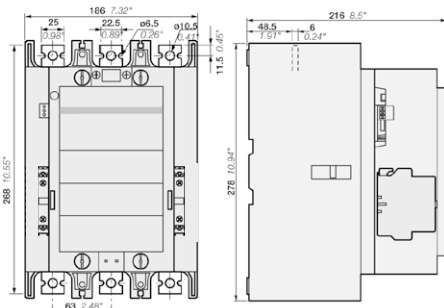
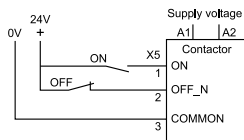

AFS400, AFS460

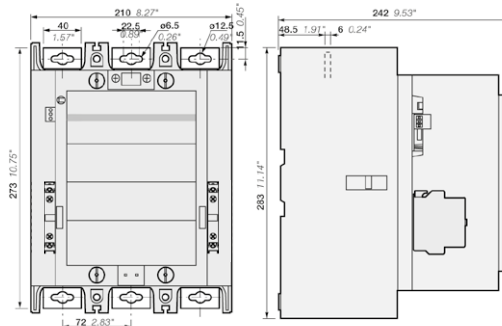

AFS580, AFS750

Main dimensions mm, inches

AFS400 ... AFS750 3-pole contactors for safety applications with 1 N.O. + 2 N.C. auxiliary contacts

Contactors and main accessories

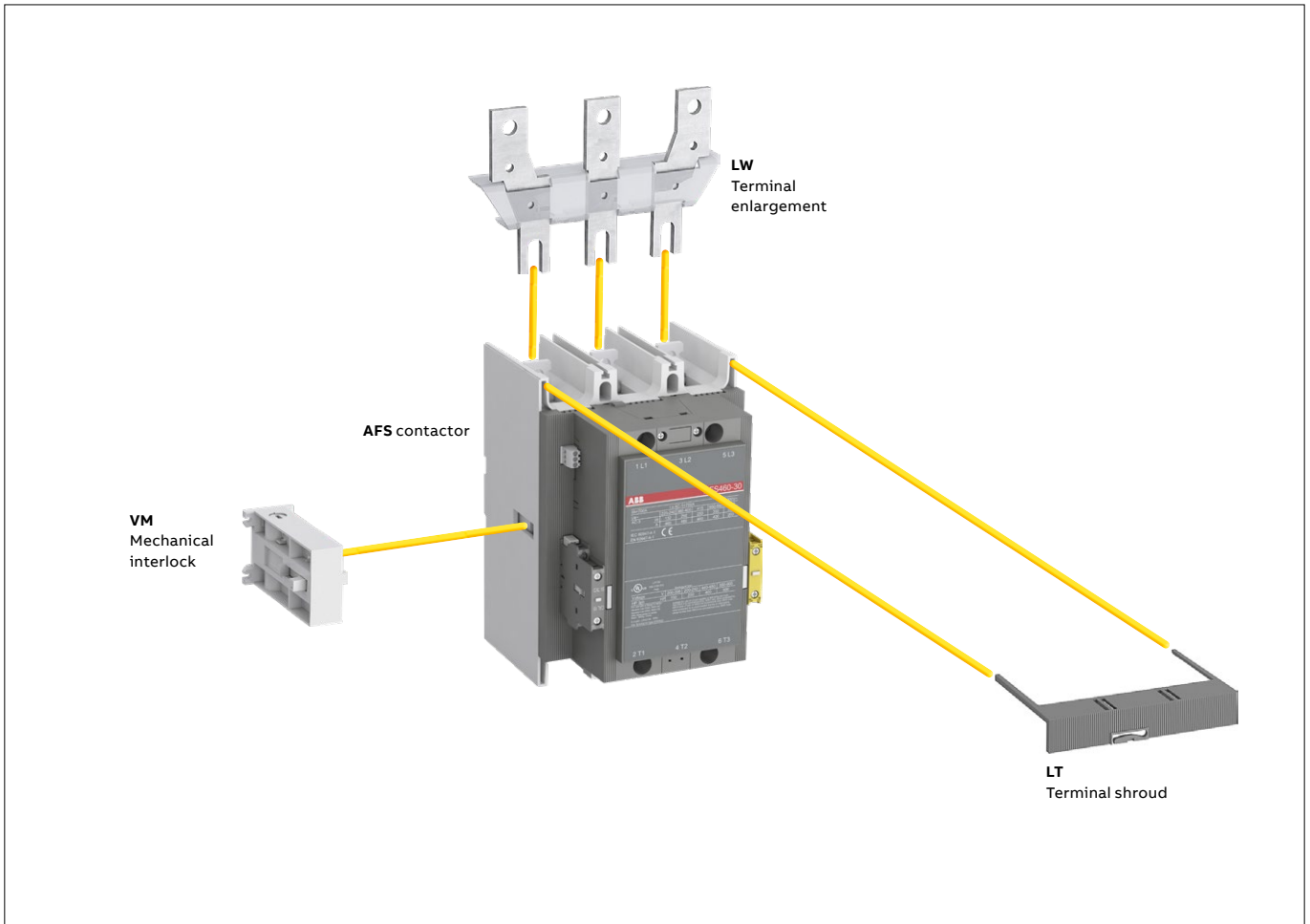

Main accessory fitting details - for ordering details, technical data and other accessories: see section accessories

Overload relays fitting details

| Contactor types | Thermal overload relays | Electronic overload relays |
|-----------------|-------------------------|----------------------------|
| AFS400, AFS460 | - | EF460 (150...500 A) (3) |
| AFS580, AFS750 | - | EF750 (250...800 A) (3) |

The addition of a thermal or electronic overload relay on the contactor does not prevent fitting of many other accessories as shown in "Main accessory fitting details" table.
 (3) Mounting kit required (see "Motor protection").

AFS400 ... AFS750 3-pole contactors for safety applications with 1 N.O. + 2 N.C. auxiliary contacts

Main accessories

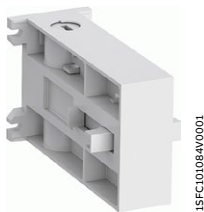

VM750H

1SFC10084V0001



LT460-AC

1SFC10089V0001

| For contactors | Type | Order code | Pkg qty | Weight (1 pce) kg |
|----------------|------|------------|---------|----------------------|
|----------------|------|------------|---------|----------------------|

Mechanical interlock unit

| | | | | |
|-------------------|--------|-----------------|---|-------|
| AFS400 ... AFS750 | VM750H | 1SFN035700R1000 | 1 | 0.200 |
|-------------------|--------|-----------------|---|-------|

Terminal shrouds

| | | | | |
|-----------------------------------|----------|-----------------|---|-------|
| AFS400, AFS460 with connectors | LT460-AC | 1SFN125701R1000 | 2 | 0.100 |
| AFS400, AFS460 with lugs | LT460-AL | 1SFN125703R1000 | 2 | 0.800 |
| AFS580 ... AFS750 with connectors | LT750-AC | 1SFN126101R1000 | 2 | 0.120 |
| AFS580 ... AFS750 with lugs | LT750-AL | 1SFN126103R1000 | 2 | 0.825 |

| For contactors | Dimensions | | Type | Order code | Pkg qty | Weight (1 pce) kg |
|----------------|--------------|-----------|------|------------|---------|----------------------|
| | hole Ø mm | bar mm | | | | |

Terminal enlargements

| | | | | | | |
|----------------|------|--------|-------|-----------------|---|-------|
| AFS400, AFS460 | 10.5 | 25 x 5 | LW460 | 1SFN075707R1000 | 1 | 0.730 |
| AFS580, AFS750 | 13 | 40 x 6 | LW750 | 1SFN076107R1000 | 1 | 1.230 |

Terminal extension

| | | | | | | |
|----------------|------|--------|-------|-----------------|---|-------|
| AFS400, AFS460 | 10.5 | 25 x 5 | LX460 | 1SFN075710R1000 | 1 | 0.500 |
| AFS580, AFS750 | 13 | 40 x 6 | LX750 | 1SFN076110R1000 | 1 | 0.850 |

AFS09 ... AFS96 3-pole contactors for safety applications

Technical data

Main pole - Utilization characteristics according to IEC

| Contactor types | AC / DC operated | AFS09 | AFS12 | AFS16 | AFS26 | AFS30 | AFS38 | AFS40 | AFS52 | AFS65 | AFS80 | AFS96 |
|--|--------------------------------|--|-------------------|-------------------|--------------------|--------------------|--------------------|--------------------|--------------------|--------------------|--------------------|--------------------|
| Standards | | IEC 60947-1 / 60947-4-1 and EN 60947-1 / 60947-4-1 | | | | | | | | | | |
| Rated operational voltage Ue max. | | 690 V | | | | | | | | | | 1000 V |
| Rated frequency (without derating) | | 50 / 60 Hz | | | | | | | | | | |
| Conventional free-air thermal current Ith | | | | | | | | | | | | |
| acc. to IEC 60947-4-1, open contactors, $\theta \leq 40^\circ\text{C}$ | | 35 A | 35 A | 35 A | 50 A | 50 A | 50 A | 105 A | 105 A | 105 A | 130 A | 130 A |
| With conductor cross-sectional area | | 6 mm ² | 6 mm ² | 6 mm ² | 10 mm ² | 10 mm ² | 10 mm ² | 35 mm ² | 35 mm ² | 35 mm ² | 50 mm ² | 50 mm ² |
| AC-1 Utilization category | | | | | | | | | | | | |
| For air temperature close to contactor | | | | | | | | | | | | |
| le / Rated operational current AC-1 | $\theta \leq 40^\circ\text{C}$ | 25 A | 28 A | 30 A | 45 A | 50 A | 50 A | 70 A | 100 A | 105 A | 125 A | 130 A |
| Ue max. $\leq 690\text{ V}, 50/60\text{ Hz}$ | $\theta \leq 60^\circ\text{C}$ | 25 A | 28 A | 30 A | 40 A | 42 A | 42 A | 60 A | 80 A | 90 A | 100 A | 105 A |
| | $\theta \leq 70^\circ\text{C}$ | 22 A | 24 A | 26 A | 32 A | 37 A | 37 A | 50 A | 70 A | 80 A | 85 A | 90 A |
| With conductor cross-sectional area | | 4 mm ² | 6 mm ² | 6 mm ² | 10 mm ² | 10 mm ² | 10 mm ² | 25 mm ² | 35 mm ² | 35 mm ² | 50 mm ² | 50 mm ² |
| AC-3 Utilization category | | | | | | | | | | | | |
| For air temperature close to contactor $\theta \leq 60^\circ\text{C}$ | | | | | | | | | | | | |
| le / Max. rated operational current AC-3 (1) | | | | | | | | | | | | |
| | 220-230-240 V | 9 A | 12 A | 18 A | 26 A | 33 A | 40 A | 40 A | 53 A | 65 A | 80 A | 96 A |
| | 380-400 V | 9 A | 12 A | 18 A | 26 A | 32 A | 38 A | 40 A | 53 A | 65 A | 80 A | 96 A |
| | 415 V | 9 A | 12 A | 18 A | 26 A | 32 A | 38 A | 40 A | 53 A | 65 A | 80 A | 96 A |
| | 440 V | 9 A | 12 A | 18 A | 26 A | 32 A | 38 A | 40 A | 53 A | 65 A | 80 A | 96 A |
| | 500 V | 9.5 A | 12.5 A | 15 A | 23 A | 28 A | 33 A | 35 A | 45 A | 55 A | 65 A | 80 A |
| | 690 V | 7 A | 9 A | 10.5 A | 17 A | 21 A | 24 A | 25 A | 35 A | 39 A | 49 A | 57 A |
| | 1000 V | | | | | | | | | | 25 A | 30 A |
| Rated operational power AC-3 (1) | | | | | | | | | | | | |
| | 220-230-240 V | 2.2 kW | 3 kW | 4 kW | 6.5 kW | 9 kW | 11 kW | 11 kW | 15 kW | 18.5 kW | 22 kW | 25 kW |
| | 380-400 V | 4 kW | 5.5 kW | 7.5 kW | 11 kW | 15 kW | 18.5 kW | 18.5 kW | 22 kW | 30 kW | 37 kW | 45 kW |
| | 415 V | 4 kW | 5.5 kW | 9 kW | 11 kW | 15 kW | 18.5 kW | 22 kW | 30 kW | 37 kW | 45 kW | 55 kW |
| | 440 V | 4 kW | 5.5 kW | 9 kW | 15 kW | 18.5 kW | 22 kW | 22 kW | 30 kW | 37 kW | 45 kW | 55 kW |
| | 500 V | 5.5 kW | 7.5 kW | 9 kW | 15 kW | 18.5 kW | 22 kW | 22 kW | 30 kW | 37 kW | 45 kW | 55 kW |
| | 690 V | 5.5 kW | 7.5 kW | 9 kW | 15 kW | 18.5 kW | 22 kW | 22 kW | 30 kW | 37 kW | 45 kW | 55 kW |
| | 1000 V | | | | | | | | | | 35 kW | 40 kW |
| Rated making capacity AC-3 | | 10 x Ie AC-3 acc. to IEC 60947-4-1 | | | | | | | | | | |
| Rated breaking capacity AC-3 | | 8 x Ie AC-3 acc. to IEC 60947-4-1 | | | | | | | | | | |
| AC-8a Utilization category | | | | | | | | | | | | |
| (without thermal overload relay | | | | | | | | | | | | |
| Ue 400 V 50/60 Hz - $\theta \leq 40^\circ\text{C}$) | | | | | | | | | | | | |
| le / Rated operational current AC-8a | | 12 A | 16 A | 22 A | 30 A | 40 A | 50 A | 53 A | 70 A | 85 A | 105 A | 120 A |
| Rated operational power AC-8a | | 5.5 kW | 7.5 kW | 11 kW | 15 kW | 20 kW | 25 kW | 25 kW | 37 kW | 45 kW | 55 kW | 65 kW |
| Short-circuit protection device for contactors | | | | | | | | | | | | |
| without thermal overload relay | | | | | | | | | | | | |
| Motor protection excluded (2) | | | | | | | | | | | | |
| Ue $\leq 500\text{ V AC}$ - gG type fuse | | 25 A | 32 A | 32 A | 50 A | 63 A | 63 A | 100 A | 125 A | 160 A | 160 A | 200 A |
| Rated short-time withstand current Icw | 1 s | 300 A | 300 A | 300 A | 700 A | 700 A | 700 A | 1000 A | 1000 A | 1000 A | 1200 A | 1200 A |
| at 40 °C ambient temperature, | 10 s | 150 A | 150 A | 150 A | 350 A | 350 A | 350 A | 600 A | 600 A | 600 A | 780 A | 780 A |
| in free air from a cold state | 30 s | 80 A | 80 A | 80 A | 225 A | 225 A | 225 A | 350 A | 350 A | 350 A | 450 A | 450 A |
| | 1 min | 60 A | 60 A | 60 A | 150 A | 150 A | 150 A | 250 A | 250 A | 250 A | 300 A | 300 A |
| | 15 min | 35 A | 35 A | 35 A | 50 A | 50 A | 50 A | 110 A | 110 A | 110 A | 140 A | 140 A |
| Maximum breaking capacity | | | | | | | | | | | | |
| cos $\phi = 0.45$ | | | | | | | | | | | | |
| | at 440 V | 250 A | 250 A | 250 A | 500 A | 500 A | 500 A | 950 A | 950 A | 950 A | 1150 A | 1150 A |
| | at 690 V | 106 A | 106 A | 106 A | 200 A | 200 A | 200 A | 600 A | 600 A | 600 A | 750 A | 750 A |
| Power dissipation per pole | Ie / AC-1 | 0.8 W | 1 W | 1.2 W | 1.8 W | 2.4 W | 2.4 W | 3 W | 6.3 W | 7 W | 7.6 W | 8.2 W |
| | Ie / AC-3 | 0.1 W | 0.2 W | 0.35 W | 0.6 W | 0.9 W | 1.3 W | 1 W | 1.7 W | 2.7 W | 3 W | 4.5 W |
| Max. electrical switching frequency | AC-1 | 600 cycles/h | | | | | | | | | | |
| | AC-3 | 1200 cycles/h | | | | | | | | | | |
| | AC-2, AC-4 | 300 cycles/h | | | | | 150 cycles/h | | | | | |
| B10d - Calculated for 50% of the rated current value Ie | | 1.3 million operating cycles | | | | | | | | | | |
| at AC-3 / 400 V | | | | | | | | | | | | |



3-phase motors



1500 r.p.m. 50 Hz
1800 r.p.m. 60 Hz
3-phase motors

(1) For the corresponding kW/A or hp/A values of 1500 r.p.m, 50 Hz or 1800 r.p.m, 60 Hz, 3-phase motors, see "Motor rated operational powers and currents".
(2) For the protection of motor starters against short circuits, see "Coordination with short-circuit protection devices".

AFS116 ... AFS370 3-pole contactors for safety applications

Technical data

Main pole - Utilization characteristics according to IEC

| Contactor types | AC / DC operated | AFS116 | AFS146 | AFS190 | AFS205 | AFS265 | AFS305 | AFS370 |
|--|--------------------------------|--|--------------------|---------------------|-------------------------|---------------------|-------------------------|-----------------------------|
| Standards | | IEC 60947-1 / 60947-4-1 and EN 60947-1 / 60947-4-1 | | | | | | |
| Rated operational voltage U_e max. | | 690 V | 1000 V | 1000 V | 1000 V | 1000 V | 1000 V | 1000 V |
| Rated frequency (without derating) | | 50 / 60 Hz | | | | | | |
| Conventional free-air thermal current I_{th} acc. to IEC 60947-4-1, open contactors, $\theta \leq 40^\circ\text{C}$ | | 160 A | 225 A | 275 A | 350 A | 400 A | 500 A | 600 A |
| With conductor cross-sectional area | | 70 mm ² | 95 mm ² | 150 mm ² | 240 mm ² (3) | 240 mm ² | 300 mm ² (4) | 2 x 185 mm ² (4) |
| AC-1 Utilization category | | | | | | | | |
| For air temperature close to contactor | | | | | | | | |
| I_e / Rated operational current AC-1 | $\theta \leq 40^\circ\text{C}$ | 160 A | 225 A | 275 A | 350 A | 400 A | 500 A | 600 A |
| U_e max. ≤ 690 V, 50/60 Hz | $\theta \leq 60^\circ\text{C}$ | 145 A | 200 A | 250 A | 300 A | 350 A | 400 A | 500 A |
| | $\theta \leq 70^\circ\text{C}$ | 130 A | 175 A | 200 A | 240 A | 290 A | 325 A | 400 A |
| I_e / Rated operational current AC-1 | $\theta \leq 40^\circ\text{C}$ | - | 225 A | 250 A | 275 A | 350 A | 375 A | 400 A |
| U_e max. ≤ 1000 V, 50/60 Hz | $\theta \leq 60^\circ\text{C}$ | - | 200 A | 225 A | 250 A | 300 A | 325 A | 350 A |
| | $\theta \leq 70^\circ\text{C}$ | - | 175 A | 185 A | 200 A | 240 A | 260 A | 290 A |
| With conductor cross-sectional area | | 70 mm ² | 95 mm ² | 150 mm ² | 240 mm ² (3) | 240 mm ² | 300 mm ² (4) | 2 x 185 mm ² (4) |
| AC-3 Utilization category | | | | | | | | |
| For air temperature close to contactor $\theta \leq 60^\circ\text{C}$ | | | | | | | | |
| I_e / Max. rated operational current AC-3 (1) | | | | | | | | |
| | 220-230-240 V | 116 A | 146 A | 190 A | 205 A | 265 A | 305 A | 370 A |
| | 380-400 V | 116 A | 146 A | 190 A | 205 A | 265 A | 305 A | 370 A |
| | 415 V | 116 A | 146 A | 190 A | 205 A | 265 A | 305 A | 370 A |
| | 440 V | 116 A | 146 A | 190 A | 205 A | 265 A | 305 A | 370 A |
| | 500 V | 110 A | 130 A | 135 A | 165 A | 250 A | 290 A | 315 A |
| | 690 V | 65 A | 93 A | 135 A | 165 A | 250 A | 290 A | 315 A |
| | 1000 V | - | 60 A | 85 A | 100 A | 100 A | 100 A | 100 A |
| Rated operational power AC-3 (1) | | | | | | | | |
| | 220-230-240 V | 30 kW | 45 kW | 55 kW | 55 kW | 75 kW | 90 kW | 110 kW |
| | 380-400 V | 55 kW | 75 kW | 90 kW | 110 kW | 132 kW | 160 kW | 200 kW |
| | 415 V | 55 kW | 75 kW | 90 kW | 110 kW | 132 kW | 160 kW | 200 kW |
| | 440 V | 75 kW | 90 kW | 110 kW | 132 kW | 160 kW | 160 kW | 200 kW |
| | 500 V | 75 kW | 90 kW | 90 kW | 110 kW | 200 kW | 200 kW | 250 kW |
| | 690 V | 55 kW | 90 kW | 132 kW | 160 kW | 200 kW | 250 kW | 315 kW |
| | 1000 V | - | 75 kW | 110 kW | 132 kW | 132 kW | 132 kW | 132 kW |
| Rated making capacity AC-3 | | 10 x I_e AC-3 acc. to IEC 60947-4-1 | | | | | | |
| Rated breaking capacity AC-3 | | 8 x I_e AC-3 acc. to IEC 60947-4-1 | | | | | | |
| Short-circuit protection device for contactors without thermal overload relay Motor protection excluded (2) | | | | | | | | |
| $U_e \leq 500$ V AC - gG type fuse | | 250 A | 315 A | 355 A | 400 A | 500 A | 500 A | 630 A |
| Rated short-time withstand current I_{cw} at 40 °C ambient temperature, in free air from a cold state | 1 s | 1300 A | 1460 A | 1900 A | 2050 A | 2650 A | 3050 A | 3700 A |
| | 10 s | 928 A | 1168 A | 1520 A | 1640 A | 2120 A | 2440 A | 2960 A |
| | 30 s | 536 A | 674 A | 878 A | 947 A | 1224 A | 1409 A | 1709 A |
| | 1 min | 379 A | 477 A | 621 A | 670 A | 865 A | 996 A | 1208 A |
| | 15 min | 160 A | 225 A | 275 A | 350 A | 400 A | 500 A | 600 A |
| Maximum breaking capacity | | | | | | | | |
| $\cos \phi = 0.45$ | at 440 V | 2000 A | 3000 A | 3300 A | 3500 A | 3800 A | 4600 A | 5000 A |
| ($\cos \phi = 0.35$ for $I_e > 100$ A) | at 690 V | 1000 A | 1500 A | 2200 A | 2500 A | 3300 A | 3800 A | 4000 A |
| Power dissipation per pole | I_e / AC-1 | 12 W | 23 W | 15 W | 25 W | 32 W | 50 W | 72 W |
| | I_e / AC-3 | 6 W | 10 W | 7 W | 8 W | 14 W | 19 W | 27 W |
| Maximum electrical switching frequency | AC-1 | 300 cycles/h | | | | | | |
| | AC-3 | 300 cycles/h | | | | | | |
| | AC-2, AC-4 | 150 cycles/h | | | | | | |
| B10d - Calculated for 50% of the rated current value I_e at AC-3 / 400 V | | 1.3 million operating cycles | | | | | | |

(1) For the corresponding kW/A or hp/A values of 1500 r.p.m. 50 Hz or 1800 r.p.m. 60 Hz, 3-phase motors, see "Motor rated operational powers and currents".

(2) For the protection of motor starters against short circuits, see "Coordination with short-circuit protection devices".

(3) For currents above 275 A use terminal enlargements or terminal extensions.

(4) For currents above 450 A use terminal enlargements or terminal extensions.

AFS400 ... AFS750 3-pole contactors for safety applications

Technical data

Main pole - Utilization characteristics according to IEC

| Contactor types | AC / DC operated | AFS400 | AFS460 | AFS580 | AFS750 |
|--|--------------------------------|--|-----------------------|-----------------------|-------------------------|
| Standards | | IEC 60947-1 / 60947-4-1 and EN 60947-1 / 60947-4-1 | | | |
| Rated operational voltage Ue max. | | 1000 V | | | |
| Rated frequency (without derating) | | 50/60 Hz | | | |
| Conventional free-air thermal current Ith acc. to IEC 60947-4-1, open contactors, $\theta \leq 40^\circ\text{C}$ | | 600 A | 700 A | 800 A | 1050 A |
| With conductor cross-sectional area (3) | | 2x185 mm ² | 2x240 mm ² | 2x240 mm ² | 800 mm ² (4) |
| AC-1 Utilization category | | | | | |
| For air temperature close to contactor | | | | | |
| le / Rated operational current AC-1 | $\theta \leq 40^\circ\text{C}$ | 600 A | 700 A | 800 A | 1050 A |
| Ue max. $\leq 690\text{ V}, 50/60\text{ Hz}$ | $\theta \leq 55^\circ\text{C}$ | 500 A | 600 A | 700 A | 875 A |
| | $\theta \leq 70^\circ\text{C}$ | 400 A | 480 A | 580 A | 720 A |
| le / Rated operational current AC-1 | $\theta \leq 40^\circ\text{C}$ | 600 A | 700 A | 800 A | 1000 A |
| Ue max. $\leq 1000\text{ V}, 50/60\text{ Hz}$ | $\theta \leq 55^\circ\text{C}$ | 500 A | 600 A | 700 A | 875 A |
| | $\theta \leq 70^\circ\text{C}$ | 400 A | 480 A | 580 A | 720 A |
| With conductor cross-sectional area | | 2x185 mm ² | 2x240 mm ² | 2x240 mm ² | 800 mm ² (4) |
| AC-3 Utilization category | | | | | |
| For air temperature close to contactor $\theta \leq 55^\circ\text{C}$ | | | | | |
| le / Max. rated operational current AC-3 (1) | | | | | |
| | 220-230-240 V | 400 A | 460 A | 580 A | 750 A |
| | 380-400 V | 400 A | 460 A | 580 A | 750 A |
| | 415 V | 400 A | 460 A | 580 A | 750 A |
| | 440 V | 400 A | 460 A | 580 A | 750 A |
| | 500 V | 400 A | 460 A | 580 A | 750 A |
| | 690 V | 350 A | 400 A | 500 A | 650 A |
| | 1000 V | 155 A | 200 A | 250 A | 300 A |
| Rated operational power AC-3 (1) | | | | | |
| | 220-230-240 V | 110 kW | 132 kW | 160 kW | 220 kW |
| | 380-400 V | 200 kW | 250 kW | 315 kW | 400 kW |
| | 415 V | 220 kW | 250 kW | 355 kW | 425 kW |
| | 440 V | 220 kW | 250 kW | 355 kW | 450 kW |
| | 500 V | 250 kW | 315 kW | 400 kW | 520 kW |
| | 690 V | 315 kW | 355 kW | 500 kW | 600 kW |
| | 1000 V | 220 kW | 280 kW | 355 kW | 400 kW |
| Rated making capacity AC-3 | | 10 x le AC-3 acc. to IEC 60947-4-1 | | | |
| Rated breaking capacity AC-3 | | 8 x le AC-3 acc. to IEC 60947-4-1 | | | |
| Short-circuit protection device for contactors without thermal overload relay | | | | | |
| Motor protection excluded (2) | | | | | |
| Ue $\leq 500\text{ V AC - gG type fuse}$ | | 630 A | 800 A | 1000 A | 1000 A |
| Rated short-time withstand current Icw at 40 °C ambient temperature, in free air from a cold state | 1 s | 4600 A | 4600 A | 7000 A | 7000 A |
| | 10 s | 4400 A | 4400 A | 6400 A | 6400 A |
| | 30 s | 3100 A | 3100 A | 4500 A | 4500 A |
| | 1 min | 2500 A | 2500 A | 3500 A | 3500 A |
| | 15 min | 840 A | 840 A | 1300 A | 1300 A |
| Maximum breaking capacity | | | | | |
| cos $\phi = 0.45$ | at 440 V | 4000 A | 5000 A | 6000 A | 7500 A |
| (cos $\phi = 0.35$ for le > 100 A) | at 690 V | 3500 A | 4500 A | 5000 A | 7000 A |
| Power dissipation per pole | le / AC-1 | 30 W | 42 W | 32 W | 50 W |
| | le / AC-3 | 16 W | 21 W | 17 W | 28 W |
| Max. electrical switching frequency | AC-1 | 300 cycles/h | | 300 cycles/h | |
| | AC-3 | 300 cycles/h | | 300 cycles/h | |
| | AC-2, AC-4 | 60 cycles/h | | 60 cycles/h | |
| B10d - Calculated for 50% of the rated current value le at AC-3 / 400 V | | 0.68 million operating cycles | | | |



3-phase motors



1500 r.p.m. 50 Hz
1800 r.p.m. 60 Hz
3-phase motors

(1) For the corresponding kW/A or hp/A values of 1500 r.p.m, 50 Hz or 1800 r.p.m, 60 Hz, 3-phase motors, see "Motor rated operational powers and currents".

(2) For the protection of motor starters against short circuits, see "Coordination with short-circuit protection devices".

(3) Conductors with preparation.

(4) Max. connection bar width 50 mm.

AFS09 ... AFS96 3-pole contactors for safety applications

Technical data

Main pole - Utilization characteristics according to UL / NEMA / CSA

| Contactor types | AC / DC operated | AFS09 | AFS12 | AFS16 | AFS26 | AFS30 | AFS38 | AFS40 | AFS52 | AFS65 | AFS80 | AFS96 | |
|---|------------------|---------------------------------------|----------|----------|----------|----------|----------|----------|----------|--------|----------|----------|--|
| Standards | | UL 60947-4-1, CSA-C22.2 No. 60947-4-1 | | | | | | | | | | | |
| Maximum operational voltage | | 600 V | | | | | | | | | | | |
| NEMA size | | 00 | 0 | - | 1 | - | - | 2 | - | - | 3 | - | |
| NEMA continuous amp rating | Thermal current | 9 A | 18 A | - | 27 A | - | - | 45 A | - | - | 90 A | - | |
| NEMA maximum horse power ratings 1-phase, 60 Hz | 115 V AC | 1/3 hp | 1 hp | - | 2 hp | - | - | 3 hp | - | - | - | - | |
| | 230 V AC | 1 hp | 2 hp | - | 3 hp | - | - | 7.5 hp | - | - | - | - | |
| NEMA maximum horse power ratings 3-phase, 60 Hz | 200 V AC | 1-1/2 hp | 3 hp | - | 7-1/2 hp | - | - | 10 hp | - | - | 25 hp | - | |
| | 230 V AC | 1-1/2 hp | 3 hp | - | 7-1/2 hp | - | - | 15 hp | - | - | 30 hp | - | |
| | 460 V AC | 2 hp | 5 hp | - | 10 hp | - | - | 25 hp | - | - | 50 hp | - | |
| | 575 V AC | 2 hp | 5 hp | - | 10 hp | - | - | 25 hp | - | - | 50 hp | - | |
| UL / CSA general use rating | | | | | | | | | | | | | |
| 600 V AC | | 25 A | 28 A | 30 A | 45 A | 50 A | 50 A | 60 A | 80 A | 90 A | 105 A | 115 A | |
| With conductor cross-sectional area | | AWG 10 | AWG 10 | AWG 10 | AWG 8 | AWG 8 | AWG 8 | AWG 6 | AWG 4 | AWG 3 | AWG 2 | AWG 2 | |
| 1 pole | 80 V DC | 25 A | 28 A | 30 A | 45 A | 50 A | 50 A | 60 A | 80 A | 90 A | 105 A | 115 A | |
| 2 poles in serie | 160 V DC | 25 A | 28 A | 30 A | 45 A | 50 A | 50 A | 60 A | 80 A | 90 A | 105 A | 115 A | |
| 3 poles in serie | 240 V DC | 25 A | 28 A | 30 A | 45 A | 50 A | 50 A | 60 A | 80 A | 90 A | 105 A | 115 A | |
| With conductor cross-sectional area | | AWG 10 | AWG 10 | AWG 10 | AWG 8 | AWG 8 | AWG 8 | AWG 6 | AWG 4 | AWG 3 | AWG 2 | AWG 2 | |
| UL / CSA maximum 1-phase motor rating | | | | | | | | | | | | | |
| Full load current | 120 V AC | 13.8 A | 16 A | 20 A | 24 A | 24 A | 24 A | 34 A | 34 A | 56 A | 80 A | 80 A | |
| | 240 V AC | 10 A | 12 A | 17 A | 17 A | 28 A | 28 A | 40 A | 50 A | 68 A | 68 A | 88 A | |
| Horse power rating | 120 V AC | 3/4 hp | 1 hp | 1-1/2 hp | 2 hp | 2 hp | 2 hp | 3 hp | 3 hp | 5 hp | 7-1/2 hp | 7-1/2 hp | |
| | 240 V AC | 1-1/2 hp | 2 hp | 3 hp | 3 hp | 5 hp | 5 hp | 7-1/2 hp | 10 hp | 15 hp | 15 hp | 20 hp | |
| UL / CSA maximum 3-phase motor rating | | | | | | | | | | | | | |
| Full load current (1) | 200-208 V AC | 7.8 A | 11 A | 17.5 A | 25.3 A | 32.2 A | 32.2 A | 32.2 A | 48.3 A | 62.1 A | 78.2 A | 92 A | |
| | 220-240 V AC | 6.8 A | 9.6 A | 15.2 A | 22 A | 28 A | 28 A | 42 A | 54 A | 68 A | 80 A | 80 A | |
| | 440-480 V AC | 7.6 A | 11 A | 14 A | 21 A | 27 A | 34 A | 40 A | 52 A | 65 A | 77 A | 77 A | |
| | 550-600 V AC | 9 A | 11 A | 17 A | 22 A | 27 A | 32 A | 41 A | 52 A | 62 A | 77 A | 77 A | |
| Horse power rating (1) | 200-208 V AC | 2 hp | 3 hp | 5 hp | 7-1/2 hp | 10 hp | 10 hp | 10 hp | 15 hp | 20 hp | 25 hp | 30 hp | |
| | 220-240 V AC | 2 hp | 3 hp | 5 hp | 7-1/2 hp | 10 hp | 10 hp | 15 hp | 20 hp | 25 hp | 30 hp | 30 hp | |
| | 440-480 V AC | 5 hp | 7-1/2 hp | 10 hp | 15 hp | 20 hp | 25 hp | 30 hp | 40 hp | 50 hp | 60 hp | 60 hp | |
| | 550-600 V AC | 7-1/2 hp | 10 hp | 15 hp | 20 hp | 25 hp | 30 hp | 40 hp | 50 hp | 60 hp | 75 hp | 75 hp | |
| UL / CSA - DC motor starting - 3 poles in series | | | | | | | | | | | | | |
| Full Load Amps | 125 V DC | 9.5 A | 13.2 A | 17 A | 25 A | 25 A | 25 A | 40 A | 58 A | 76 A | 76 A | 110 A | |
| | 250 V DC | 8.5 A | 12.2 A | 12.2 A | 20 A | 29 A | 29 A | 38 A | 55 A | 72 A | 89 A | 106 A | |
| Horse power rating | 125 V DC | 1 hp | 1-1/2 hp | 2 hp | 3 hp | 3 hp | 3 hp | 5 hp | 7-1/2 hp | 10 hp | 10 hp | 15 hp | |
| | 250 V DC | 2 hp | 3 hp | 3 hp | 5 hp | 7-1/2 hp | 7-1/2 hp | 10 hp | 15 hp | 20 hp | 25 hp | 30 hp | |
| Short-circuit protection device for contactors without thermal overload relay - Motor protection excluded | | | | | | | | | | | | | |
| High fault current | | 100 kA | | | | | | | | | | | |
| Fuse rating | | 30 A | | 60 A | | | 100 A | | 150 A | | | 200 A | |
| Fuse type, 600 V | | J | | | | | | | | | | | |
| Maximum electrical switching frequency | | | | | | | | | | | | | |
| For general use | | 600 cycles/h | | | | | | | | | | | |
| For motor use | | 1200 cycles/h | | | | | | | | | | | |

(1) For the corresponding kW/A or hp/A values of 1500 r.p.m, 50 Hz or 1800 r.p.m, 60 Hz, 3-phase motors, see "Motor rated operational powers and currents".

AFS116 ... AFS370 3-pole contactors for safety applications

Technical data

Main pole - Utilization characteristics according to UL / NEMA / CSA

| Contactors types | AC / DC operated | AFS116 | AFS146 | AFS190 | AFS205 | AFS265 | AFS305 | AFS370 |
|---|------------------|---|---------|---------|-------------|---------|------------|------------|
| Standards | | UL 60947-1 / 60947-4-1 and CSA C 22.2 N°60947-1 / 60947-4-1 | | | | | | |
| Maximum operational voltage | | 600 V | 1000 V | | | | | |
| NEMA size | | - | - | - | - | 5 | - | - |
| NEMA continuous amp rating | Thermal current | - | - | - | - | 270 A | - | - |
| NEMA maximum horse power ratings | 115 V AC | - | - | - | - | - | - | - |
| 1-phase, 60 Hz | 230 V AC | - | - | - | - | - | - | - |
| NEMA maximum horse power ratings | 200 V AC | - | - | - | - | 75 hp | - | - |
| 3-phase, 60 Hz | 230 V AC | - | - | - | - | 100 hp | - | - |
| | 460 V AC | - | - | - | - | 200 hp | - | - |
| | 575 V AC | - | - | - | - | 200 hp | - | - |
| UL / CSA general use rating | | | | | | | | |
| 600 V AC | | 160 A | 200 A | 250 A | 300 A | 350 A | 400 A | 520 A |
| With conductor cross-sectional area | | AWG 2/0 | AWG 3/0 | MCM 250 | MCM 350 (2) | MCM 500 | 2//AWG 3/0 | 2//MCM 300 |
| 1000 V AC | | - | 200 A | 250 A | 275 A | 300 A | 350 A | 400 A |
| With conductor cross-sectional area | | AWG 2/0 | AWG 3/0 | MCM 250 | MCM 350 (2) | MCM 500 | 2//AWG 3/0 | 2//MCM 300 |
| 1 pole | 90 V DC | 160 A | 200 A | - | - | - | - | - |
| | 100 V DC | - | - | 250 A | 350 A | - | - | - |
| | 110 V DC | - | - | - | - | 400 A | 500 A | 520 A |
| 2 poles in serie | 175 V DC | 160 A | 200 A | - | - | - | - | - |
| | 200 V DC | - | - | 250 A | 350 A | - | - | - |
| | 225 V DC | - | - | - | - | 400 A | 500 A | 520 A |
| 3 poles in serie | 260 V DC | 160 A | 200 A | - | - | - | - | - |
| | 300 V DC | - | - | 250 A | 350 A | - | - | - |
| | 340 V DC | - | - | - | - | 400 A | 500 A | 520 A |
| With conductor cross-sectional area | | AWG 2/0 | AWG 3/0 | MCM 250 | MCM 350 (2) | MCM 500 | 2//AWG 3/0 | 2//MCM 300 |
| UL / CSA maximum 1-phase motor rating | | | | | | | | |
| Full load current | 120 V AC | - | - | - | - | - | - | - |
| | 240 V AC | - | - | - | - | - | - | - |
| Horse power rating | 120 V AC | - | - | - | - | - | - | - |
| | 240 V AC | - | - | - | - | - | - | - |
| UL / CSA maximum 3-phase motor rating | | | | | | | | |
| Full load current (1) | 200-208 V AC | 92 A | 120 A | 150 A | 177 A | 221 A | 285 A | 359 A |
| | 220-240 V AC | 104 A | 130 A | 154 A | 192 A | 248 A | 312 A | 360 A |
| | 440-480 V AC | 96 A | 124 A | 156 A | 180 A | 240 A | 302 A | 361 A |
| | 550-600 V AC | 99 A | 125 A | 144 A | 192 A | 242 A | 289 A | 336 A |
| Horse power rating (1) | 200-208 V AC | 30 hp | 40 hp | 50 hp | 60 hp | 75 hp | 100 hp | 125 hp |
| | 220-240 V AC | 40 hp | 50 hp | 60 hp | 75 hp | 100 hp | 125 hp | 150 hp |
| | 440-480 V AC | 75 hp | 100 hp | 125 hp | 150 hp | 200 hp | 250 hp | 300 hp |
| | 550-600 V AC | 100 hp | 125 hp | 150 hp | 200 hp | 250 hp | 300 hp | 350 hp |
| Short-circuit protection device for contactors without thermal overload relay - Motor protection excluded | | | | | | | | |
| High fault current | | 100 kA | | | | | | |
| Fuse rating | | 225 A | 250 A | 350 A | 400 A | 500 A | 600 A | 600 A |
| Fuse type, 600 V | | J | | | | | | |
| Maximum electrical switching frequency | | | | | | | | |
| For general use | | 300 cycles/h | | | | | | |
| For motor use | | 300 cycles/h | | | | | | |

(1) For the corresponding kW/A or hp/A values of 1500 r.p.m, 50 Hz or 1800 r.p.m, 60 Hz, 3-phase motors, see "Motor rated operational powers and currents".

(2) For conductor cross-sectional area above MCM 300 use terminal enlargements LW205.

AFS400 ... AFS750 3-pole contactors for safety applications

Technical data

Main pole - Utilization characteristics according to UL / NEMA / CSA

| Contactors types | AC / DC operated | AFS400 | AFS460 | AFS580 | AFS750 |
|---|------------------|---|--------|--------|---------|
| Standards | | UL 60947-1 / 60947-4-1 and CSA C 22.2 N°60947-1 / 60947-4-1 | | | |
| Maximum operational voltage | | 1000 V | | | |
| NEMA size | | - | 6 | - | 7 |
| NEMA maximum horse power ratings | | | | | |
| 1-phase, 60 Hz | 115 V AC | - | | | |
| | 230 V AC | - | | | |
| NEMA maximum horse power ratings | | | | | |
| 3-phase, 60 Hz | 200 V AC | - | 150 hp | - | - |
| | 230 V AC | - | 200 hp | - | 300 hp |
| | 460 V AC | - | 400 hp | - | 600 hp |
| | 575 V AC | - | 400 hp | - | 600 hp |
| UL / CSA general use rating | | | | | |
| 1000 V AC | | 550 A | 650 A | 750 A | 900 A |
| 3 poles in serie | 600 V DC | 550 A | 650 A | 750 A | 900 A |
| UL / CSA maximum 1-phase motor rating | | | | | |
| Full load current | 120 V AC | - | - | - | - |
| | 240 V AC | - | - | - | - |
| Horse power rating | 120 V AC | - | - | - | - |
| | 240 V AC | - | - | - | - |
| UL / CSA maximum 3-phase motor rating | | | | | |
| Full load current (1) | 200-208 V AC | 358.8 A | 414 A | 552 A | 692.3 A |
| | 220-240 V AC | 360 A | 480 A | 604 A | 722 A |
| | 440-480 V AC | 414 A | 477 A | 590 A | 722 A |
| | 550-600 V AC | 382 A | 472 A | 578 A | 672 A |
| Horse power rating (1) | 200-208 V AC | 125 hp | 150 hp | 200 hp | 250 hp |
| | 220-240 V AC | 150 hp | 200 hp | 250 hp | 300 hp |
| | 440-480 V AC | 350 hp | 400 hp | 500 hp | 600 hp |
| | 550-600 V AC | 400 hp | 500 hp | 600 hp | 700 hp |
| Short-circuit protection device for contactors without thermal overload relay - Motor protection excluded | | | | | |
| Fuse rating | | 1000 A | | 1200 A | |
| Fuse type, 600 V | | L | | | |
| Maximum electrical switching frequency | | | | | |
| For general use | | 300 cycles/h | | | |
| For motor use | | 300 cycles/h | | | |

(1) For the corresponding kW/A or hp/A values of 1500 r.p.m, 50 Hz or 1800 r.p.m, 60 Hz, 3-phase motors, see "Motor rated operational powers and currents".

AFS09 ... AFS96 3-pole contactors for safety applications

Technical data

General technical data

| Contactors types | AC / DC operated | AFS09 | AFS12 | AFS16 | AFS26 | AFS30 | AFS38 |
|---|------------------------------------|--|-------|-------|-------|-------|-------|
| Rated insulation voltage Ui | | 690 V | | | | | |
| acc. to IEC 60947-4-1 | | 600 V | | | | | |
| acc. to UL / CSA | | 6 kV | | | | | |
| Rated impulse withstand voltage Uimp. | | 6 kV | | | | | |
| Electromagnetic compatibility | | Devices complying with IEC 60947-1 / EN 60947-1 - Environments A and B | | | | | |
| Ambient air temperature close to contactor | | | | | | | |
| Operation | Fitted with thermal overload relay | -40 ... +60 °C | | | | | |
| | Without thermal overload relay | -40 ... +70 °C | | | | | |
| Storage | | -60 ... +80 °C | | | | | |
| Climatic withstand | | Category B according to IEC 60947-1 Annex Q | | | | | |
| Maximum operating altitude (without derating) | | 3000 m | | | | | |
| Mechanical durability | | | | | | | |
| Number of operating cycles | | 10 million operating cycles | | | | | |
| Maximum switching frequency | | 3600 cycles/h | | | | | |
| Shock withstand | | | | | | | |
| acc. to IEC 60068-2-27 and EN 60068-2-27 | | | | | | | |
| Mounting position 1 | Shock direction | 1/2 sinusoidal shock for 11 ms: no change in contact position, closed or open position | | | | | |
| | A | 30 g | | | | | |
| | B1 | 25 g closed position / 5 g open position | | | | | |
| | B2 | 15 g | | | | | |
| | C1 | 25 g | | | | | |
| | C2 | 25 g | | | | | |
| Vibration withstand | | 5 ... 300 Hz | | | | | |
| acc. to IEC 60068-2-6 | | 4 g Closed position / 2 g Open position | | | | | |

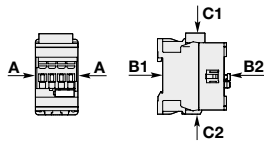

Mounting characteristics and conditions for use

| Contactors types | AC / DC operated | AFS09 | AFS12 | AFS16 | AFS26 | AFS30 | AFS38 |
|--|------------------|--|-------|-------|-------|-------|-------|
| Mounting positions | | | | | | | |
| Mounting distances | | The contactors can be assembled side by side | | | | | |
| Fixing | | | | | | | |
| On rail according to IEC 60715, EN 60715 | | 35 x 7.5 mm or 35 x 15 mm | | | | | |
| By screws (not supplied) | | 2 x M4 screws placed diagonally | | | | | |

AFS09 ... AFS38 3-pole contactors for safety applications

Technical data

Magnet system characteristics for AFS09 ... AFS38 contactors - AC / DC operated

| Contactor types | AC / DC operated | AFS09 | AFS12 | AFS16 | AFS26 | AFS30 | AFS38 |
|--|-----------------------|---|-------|-------|-------|-------|-------|
| Coil operating limits acc. to IEC 60947-4-1 | AC supply | At $\theta \leq 60^\circ\text{C}$ $0.85 \times U_c \text{ min} \dots 1.1 \times U_c \text{ max}$. At $\theta \leq 70^\circ\text{C}$ $0.85 \times U_c \text{ min} \dots U_c \text{ max}$. | | | | | |
| | DC supply | at $\theta \leq 60^\circ\text{C}$ $0.85 \times U_c \text{ min} \dots 1.1 \times U_c \text{ max}$ at $\theta \leq 70^\circ\text{C}$ $0.85 \times U_c \text{ min} \dots U_c \text{ max}$ | | | | | |
| AC control voltage 50/60 Hz | | | | | | | |
| Rated control circuit voltage U_c | | 24 ... 250 V AC | | | | | |
| Coil consumption | Average pull-in value | 50 VA | | | | | |
| | Average holding value | 2.2 VA / 2 W | | | | | |
| DC control voltage | | | | | | | |
| Rated control circuit voltage U_c | | 20 ... 250 V DC | | | | | |
| Coil consumption | Average pull-in value | 50 W | | | | | |
| | Average holding value | 2 W | | | | | |
| PLC-output control | | AFS...30-22-11 not suitable for direct control by PLC-output. | | | | | |
| Drop-out voltage | | $\leq 60\% U_c \text{ min}$. | | | | | |
| Operating time | | | | | | | |
| Between coil energization and: | N.O. contact closing | 40 ... 95 ms | | | | | |
| | N.C. contact opening | 38 ... 90 ms | | | | | |
| Between coil de-energization and: | N.O. contact opening | 11 ... 95 ms (1) | | | | | |
| | N.C. contact closing | 13 ... 98 ms | | | | | |

(1) AFS09 ... AFS38 ≤ 35 ms for $20^\circ\text{C} \leq \theta \leq 70^\circ\text{C}$

Magnet System Characteristics for AFS09Z ... AFS38Z contactors 24V DC operated - designed for PLC - coil 30

| Contactor types | DC operated | AFS09Z | AFS12Z | AFS16Z | AFS26Z | AFS30Z | AFS38Z |
|--|-----------------------|--|--------|--------|--------|--------|--------|
| Coil operating limits acc. to IEC 60947-4-1 | DC supply | at $\theta \leq 60^\circ\text{C}$ $0.85 \dots 1.1 \times U_c$ at $\theta \leq 70^\circ\text{C}$ U_c | | | | | |
| | | | | | | | |
| DC control voltage | | | | | | | |
| Rated control circuit voltage U_c | | 24 V DC | | | | | |
| Coil consumption | Average pull-in value | 6 W | | | | | |
| | Average holding value | 1.7 W | | | | | |
| PLC-output control | | ≥ 250 mA 24 V DC for PLCs and safety PLCs using broken wire detection | | | | | |
| Drop-out voltage | | $\leq 60\% U_c \text{ min}$. | | | | | |
| Operating time | | | | | | | |
| Between coil energization and: | N.O. contact closing | 27 ... 53 ms | | | | | |
| | N.C. contact opening | 20 ... 35 ms | | | | | |
| Between coil de-energization and: | N.O. contact opening | 17 ... 29 ms | | | | | |
| | N.C. contact closing | 22 ... 57 ms | | | | | |

AFS40 ... AFS96 3-pole contactors for safety applications

Technical data

General technical data

| Contactor types | AC / DC operated | AFS40 | AFS52 | AFS65 | AFS80 | AFS96 |
|---|------------------------------------|--|-------|-------|--------|-------|
| Rated insulation voltage Ui | | | | | 1000 V | |
| acc. to IEC 60947-4-1 | | 690 V | | | | |
| acc. to UL / CSA | | 600 V | | | | |
| Rated impulse withstand voltage Uimp. | | | | | 8 kV | |
| Electromagnetic compatibility | | Devices complying with IEC 60947-1 / EN 60947-1 - Environments A and B | | | | |
| Ambient air temperature close to contactor | | | | | | |
| Operation | Fitted with thermal overload relay | -40...+70 °C | | | | |
| | Without thermal overload relay | -40...+70 °C | | | | |
| Storage | | -60...+80 °C | | | | |
| Climatic withstand | | Category B according to IEC 60947-1 Annex Q | | | | |
| Maximum operating altitude (without derating) | | 3000 m | | | | |
| Mechanical durability | | | | | | |
| Number of operating cycles | | 10 million operating cycles | | | | |
| Maximum switching frequency | | 3600 cycles/h | | | | |
| Shock withstand | | | | | | |
| acc. to IEC 60068-2-27 and EN 60068-2-27 | | | | | | |
| Mounting position 1 | Shock direction | 1/2 sinusoidal shock for 11 ms: no change in contact position, closed or open position | | | | |
| | A | 25 g | | | | |
| | B1 | 25 g closed position / 5 g open position | | | | |
| | B2 | 15 g | | | | |
| | C1 | 25 g | | | | |
| | C2 | 25 g | | | | |
| Vibration withstand | | 5 ... 300 Hz | | | | |
| acc. to IEC 60068-2-6 | | 3 g Closed position / 3 g Open position | | | | |

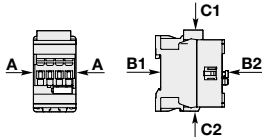

Magnet system characteristics for AFS40 ... AFS96 contactors - AC / DC operated

| Contactor types | AC / DC operated | AFS40 | AFS52 | AFS65 | AFS80 | AFS96 |
|-----------------------------------|-----------------------|--|-------|-------|-------|-------|
| Coil operating limits | AC supply | At $\theta \leq 70^\circ\text{C}$ $0.85 \times U_c \text{ min} \dots 1.1 \times U_c \text{ max}$. | | | | |
| acc. to IEC 60947-4-1 | DC supply | at $\theta \leq 70^\circ\text{C}$ $0.85 \times U_c \text{ min} \dots 1.1 \times U_c \text{ max}$ | | | | |
| AC control voltage 50/60 Hz | | | | | | |
| Rated control circuit voltage Uc | | 24 ... 250 V AC | | | | |
| Coil consumption | Average pull-in value | 25 VA | | | 40 VA | |
| | Average holding value | 4 VA / 2 W | | | | |
| DC control voltage | | | | | | |
| Rated control circuit voltage Uc | | 20 ... 250 V DC | | | | |
| Coil consumption | Average pull-in value | 25 W | | | 40 W | |
| | Average holding value | 2 W | | | | |
| PLC-output control | | AFS...30-22-11 not suitable for direct control by PLC-output. | | | | |
| Drop-out voltage | | $\leq 60\% U_c \text{ min}$. | | | | |
| Operating time | | | | | | |
| Between coil energization and: | N.O. contact closing | 42 ... 100 ms | | | | |
| | N.C. contact opening | 38 ... 95 ms | | | | |
| Between coil de-energization and: | N.O. contact opening | 17 ... 100 ms | | | | |
| | N.C. contact closing | 19 ... 105 ms | | | | |

Mounting characteristics and conditions for use

| Contactor types | AC / DC operated | AFS40 | AFS52 | AFS65 | AFS80 | AFS96 |
|--|------------------|--|-------|-------|------------|-------|
| Mounting positions | | | | | | |
| Mounting distances | | The contactors can be assembled side by side | | | | |
| Fixing | | | | | | |
| On rail according to IEC 60715, EN 60715 | | 35 x 7.5 mm or 35 x 15 mm | | | 35 x 15 mm | |
| By screws (not supplied) | | 2 x M4 or 2 x M6 screws placed diagonally | | | | |

AFS116 ... AFS370 3-pole contactors for safety applications

Technical data

General technical data

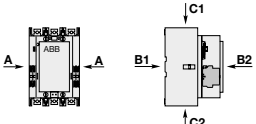
| Contactor types | AC / DC operated | AFS116 | AFS146 | AFS190 | AFS205 | AFS265 | AFS305 | AFS370 |
|---|------------------------------------|---|--------|--------|--|--------|--------|--------|
| Rated insulation voltage Ui acc. to IEC 60947-4-1 | | 1000 V | | | | | | |
| acc. to UL / CSA | | 600 V | | | | | | |
| Rated impulse withstand voltage Uimp. | | 8 kV | | | | | | |
| Electromagnetic compatibility | | AFS contactors comply with IEC 60947-1 / EN 60947-1 - Environment A | | | | | | |
| Ambient air temperature close to contactor | | | | | | | | |
| Operation | Fitted with thermal overload relay | -25 to +55 °C | | | | | | |
| | Without thermal overload relay | -40 to +70 °C | | | | | | |
| Storage | | -40 to +70 °C | | | | | | |
| Climatic withstand | | Category B according to IEC 60947-1 Annex Q | | | | | | |
| Maximum operating altitude (without derating) | | 3000 m | | | | | | |
| Mechanical durability | | | | | | | | |
| Number of operating cycles | | 5 million operating cycles | | | | | | |
| Maximum switching frequency | | 300 cycles/h | | | | | | |
| Shock withstand acc. to IEC 60068-2-27 and EN 60068-2-27 | | | | | | | | |
| Mounting position 1 | | No change in contact position, closed or open position | | | | | | |
| | Shock direction | 1/2 sinusoidal shock for 11 ms | | | 1/2 sinusoidal shock for 30 ms | | | |
|  | A | 20 g | | | 20 g | | | |
| | B1 | 15 g closed position / 3 g open position | | | 15 g closed position / 3 g open position | | | |
| | B2 | 15 g closed position / 3 g open position | | | 15 g closed position / 3 g open position | | | |
| | C1 | 20 g | | | 20 g | | | |
| | C2 | 20 g | | | 20 g | | | |
| Vibration withstand acc to IEC 60068-2-6 | | 0.7 g closed position / 0.7 g open position 13.2...100 Hz | | | | | | |

Magnet system characteristics

| Contactor types | AC / DC operated | AFS116 | AFS146 | AFS190 | AFS205 | AFS265 | AFS305 | AFS370 |
|--|-----------------------|--|--------|------------|--------|------------|--------|--------|
| Coil operating limits acc. to IEC 60947-4-1 | AC supply | At $\theta \leq 70^\circ\text{C}$ $0.85 \times U_c \text{ min} \dots 1.1 \times U_c \text{ max}$ | | | | | | |
| | DC supply | At $\theta \leq 70^\circ\text{C}$ $0.80 \times U_c \text{ min} \dots 1.1 \times U_c \text{ max}$ | | | | | | |
| Rated control circuit voltage Uc | | 24...500 V AC, 20...500 V DC | | | | | | |
| Coil consumption | | | | | | | | |
| AC control voltage 50/60 Hz | | | | | | | | |
| 24...60 V AC | Average pull-in value | 225 VA | | 165 VA | | 475 VA | | |
| | Average holding value | 5.5 VA | | 6 VA | | 8.5 VA | | |
| 48...130 V AC | Average pull-in value | 170 VA | | 175 VA | | 340 VA | | |
| | Average holding value | 4 VA | | 4 VA | | 17 VA | | |
| 100...250 V AC | Average pull-in value | 130 VA | | 220 VA | | 385 VA | | |
| | Average holding value | 6 VA | | 7 VA | | 17.5 VA | | |
| 250...500 V AC | Average pull-in value | 205 VA | | 185 VA | | 420 VA | | |
| | Average holding value | 16 VA | | 16 VA | | 21 VA | | |
| DC control voltage | | | | | | | | |
| 20...60 V DC | Average pull-in value | 210 W | | 205 W | | 400 W | | |
| | Average holding value | 2.5 W | | 2.5 W | | 3.5 W | | |
| 48...130 V DC | Average pull-in value | 130 W | | 130 W | | 360 W | | |
| | Average holding value | 2.5 W | | 2.5 W | | 2.5 W | | |
| 100...250 V DC | Average pull-in value | 135 W | | 190 W | | 410 W | | |
| | Average holding value | 3 W | | 2.5 W | | 4.5 W | | |
| 250...500 V DC | Average pull-in value | 205 W | | 190 W | | 600 W | | |
| | Average holding value | 4 W | | 4 W | | 4.7 W | | |
| Drop-out voltage | | 55 % of Uc min | | | | | | |
| Voltage sag immunity acc. to SEMI F47 | | Conditions of use on request | | | | | | |
| Dips withstand | | ≥ 20 ms | | | | | | |
| Operating time | | | | | | | | |
| Coil supply between A1 - A2 | | | | | | | | |
| Between coil energization and: | N.O. contact closing | 20...55 ms | | 25...60 ms | | 30...60 ms | | |
| Between coil de-energization and: | N.O. contact opening | 40...70 ms | | 45...80 ms | | 45...80 ms | | |

Mounting characteristics and conditions for use

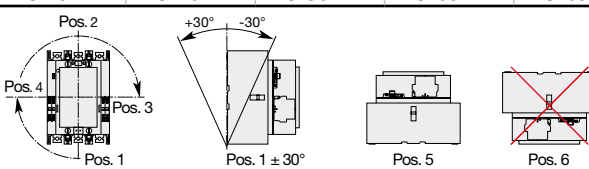
| Contactor types | AC / DC operated | AFS116 | AFS146 | AFS190 | AFS205 | AFS265 | AFS305 | AFS370 |
|-------------------------------------|------------------|--|--------|--------|--------|--------|--------|--------|
| Mounting positions | |  | | | | | | |
| Mounting distances | | The contactors can be assembled side by side | | | | | | |
| Fixing | | | | | | | | |
| On rail acc. to IEC 60715, EN 60715 | | - | | | | | | |
| By screws | | 4 x M4 | | | 4 x M5 | | | |

AFS400 ... AFS750 3-pole contactors for safety applications

Technical data

General technical data

| Contactor types | AC / DC operated | AFS400 | AFS460 | AFS580 | AFS750 |
|--|---------------------------------------|--|--------|--------|--------|
| Rated insulation voltage Ui acc. to IEC 60947-4-1 acc. to UL / CSA | | 1000 V 600 V | | | |
| Rated impulse withstand voltage Uimp. | | 8 kV | | | |
| Electromagnetic compatibility | | AFS contactors complying with IEC 60947-1 / EN 60947-1 - Environment A | | | |
| Ambient air temperature close to contactor | | | | | |
| Operation | Fitted with electronic overload relay | -25 to +70 °C | | | |
| Storage | Without electronic overload relay | -40 to +70 °C | | | |
| Climatic withstand | | Category B according to IEC 60947-1 Annex Q | | | |
| Maximum operating altitude (without derating) | | 3000 m | | | |
| Mechanical durability | | | | | |
| Number of operating cycles | | 3 millions operating cycles | | | |
| Max. switching frequency | | 300 cycles/h | | | |
| Shock withstand acc. to IEC 60068-2-27 and EN 60068-2-27 | | | | | |
| Mounting position 1 | | Shock direction 1/2 sinusoidal shock for 30 ms: no change in contact position, closed or open position | | | |
| | | A | B1 | B2 | C1 |
| | | 5 g | 5 g | 5 g | 5 g |
| | | | | | C2 |
| | | | | | 5 g |
| Vibration withstand acc to IEC 60068-2-6 | | 0.7 g closed position / 0.7 g open position 13.2...100 Hz | | | |

Magnet system characteristics

| Contactor types | AC / DC operated | AFS400 | AFS460 | AFS580 | AFS750 |
|--|-----------------------|--|--------|---------|------------|
| Coil operating limits acc. to IEC 60947-4-1 | AC supply | At $\theta \leq 70^\circ\text{C}$ $0.85 \times U_c \text{ min} \dots 1.1 \times U_c \text{ max}$ | | | |
| | DC supply | At $\theta \leq 70^\circ\text{C}$ $0.80 \times U_c \text{ min} \dots 1.1 \times U_c \text{ max}$ | | | |
| Rated control circuit voltage Uc | | 48...500 V AC, 24...500 V DC | | | |
| Coil consumption | | | | | |
| AC control voltage 50/60 Hz | | | | | |
| 48...130 V AC | Average pull-in value | 1215 VA | | 1100 VA | |
| | Average holding value | 12 VA | | 12 VA | |
| 100...250 V AC | Average pull-in value | 955 VA | | 880 VA | |
| | Average holding value | 12 VA | | 12 VA | |
| 250 ... 500 V AC | Average pull-in value | 950 VA | | 985 VA | |
| | Average holding value | 12 VA | | 12 VA | |
| DC control voltage | | | | | |
| 24...60 V DC | Average pull-in value | 900 W | | 785 W | |
| | Average holding value | 5 W | | 5.5 W | |
| 48...130 V DC | Average pull-in value | 1150 W | | 1020 W | |
| | Average holding value | 5 W | | 5 W | |
| 100...250 V DC | Average pull-in value | 895 W | | 880 W | |
| | Average holding value | 5 W | | 5 W | |
| 250 ... 500 V DC | Average pull-in value | 885 W | | 910 W | |
| | Average holding value | 7.5 W | | 7.5 W | |
| Drop-out voltage | | 55 % of Uc min. | | | |
| Voltage sag immunity acc. to SEMI F47 | | Conditions of use on request | | | |
| Dips withstand | | ≥ 20 ms | | | |
| Operating time | | | | | |
| Coil supply between A1 - A2 | | | | | |
| Between coil energization and: | Main contact closing | 50...120 ms | | | |
| Between coil de-energization and: | Main contact opening | 33...70 ms | | | |
| Control input for PLC's | | | | | |
| Between coil energization and: | Main contact closing | 40...60 ms | | | 40...90 ms |
| Between coil de-energization and: | Main contact opening | 10...30 ms | | | |

















Mounting characteristics and conditions for use

| Contactor types | AC / DC operated | AFS400 | AFS460 | AFS580 | AFS750 |
|--|------------------|--|--------|--------|--------|
| Mounting positions | | | | | |
| Mounting distances | | The contactors can be assembled side by side | | | |
| Fixing | | | | | |
| On rail according to IEC 60715, EN 60715 | | - | | | |
| By screws | | 4 x M5 | | 4 x M6 | |

AFS09 ... AFS96 3-pole contactors for safety applications

Technical data











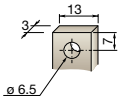
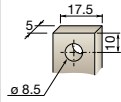
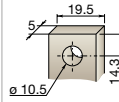

Connecting characteristics

| Contactor types | AC / DC operated | AFS09 | AFS12 | AFS16 | AFS26 | AFS30 | AFS38 | AFS40 | AFS52 | AFS65 | AFS80 | AFS96 |
|---|---------------------------------|---|------------------------------|-------|-------------------------------------|----------------------------|-------|--|--------------------------|---|--------------------------|-------|
| Main terminals | |  Screw terminals with cable clamp | | | | | |  Screw terminals with double connector 2 x (9.3 width x 7.9/10.3 depth) | |  Screw terminals with double connector 2 x (12.4 width x 9.3/11.1 depth) | | |
| Connection capacity (min. ... max.) | | | | | | | | | | | | |
| Main conductors (poles) | | | | | | | | | | | | |
|  Rigid | Solid ($\leq 4 \text{ mm}^2$) | 1 x | 1 ... 6 mm ² | | | 2.5 ... 10 mm ² | | | 6 ... 35 mm ² | | 6 ... 70 mm ² | |
|  Stranded ($6 > 6 \text{ mm}^2$) | | 2 x | 1 ... 6 mm ² | | | 2.5 ... 10 mm ² | | | 6 ... 35 mm ² | | 6 ... 50 mm ² | |
|  Flexible with non insulated ferrule | | 1 x | 0.75 ... 6 mm ² | | | 1.5 ... 10 mm ² | | | 4 ... 35 mm ² | | 6 ... 50 mm ² | |
|  Flexible with non insulated ferrule | | 2 x | 0.75 ... 6 mm ² | | | 1.5 ... 10 mm ² | | | 4 ... 35 mm ² | | 6 ... 50 mm ² | |
|  Flexible with insulated ferrule | | 1 x | 0.75 ... 4 mm ² | | | 1.5 ... 10 mm ² | | | 4 ... 35 mm ² | | 6 ... 50 mm ² | |
|  Flexible with insulated ferrule | | 2 x | 0.75 ... 2.5 mm ² | | | 1.5 ... 4 mm ² | | | 4 ... 35 mm ² | | 6 ... 50 mm ² | |
|  Bars or lugs | | L < | 9.6 mm | | | 12.5 mm | | | 9.2 mm | | 12.2 mm | |
| Connection capacity acc. to UL/CSA | 1 or 2 x | AWG 16 ... 10 | | | AWG 14 ... 8 | | | AWG 10 ... 2 | | AWG 6 ... 1 | | |
| Stripping length | | 10 mm | | | 14 mm | | | 16 mm | | 17 mm | | |
| Tightening torque | | 1.5 Nm / 13 lb.in | | | 2.5 Nm / 22 lb.in | | | 4 Nm / 35 lb.in | | 6 Nm / 53 lb.in | | |
| Auxiliary conductors (built-in auxiliary terminals + coil terminals) | | | | | | | | | | | | |
|  Rigid solid | | 1 x | 1 ... 2.5 mm ² | | | | | | | | | |
|  Rigid solid | | 2 x | 1 ... 2.5 mm ² | | | | | | | | | |
|  Flexible with non insulated ferrule | | 1 x | 0.75 ... 2.5 mm ² | | | | | | | | | |
|  Flexible with non insulated ferrule | | 2 x | 0.75 ... 2.5 mm ² | | | | | | | | | |
|  Flexible with insulated ferrule | | 1 x | 0.75 ... 2.5 mm ² | | | | | | | | | |
|  Flexible with insulated ferrule | | 2 x | 0.75 ... 1.5 mm ² | | | | | | | | | |
|  Bars or lugs | | L < | 8 mm | | | | | | | | | |
| Connection capacity acc. to UL/CSA | 1 or 2 x | AWG 18 ... 14 | | | | | | | | | | |
| Stripping length | | 10 mm | | | | | | | | | | |
| Tightening torque | | | | | | | | | | | | |
| Coil terminals | | 1.2 Nm / 11 lb.in | | | | | | | | | | |
| Built-in auxiliary terminals | | 1.2 Nm / 11 lb.in | | | | | | | | | | |
| Degree of protection acc. to IEC 60947-1 / EN 60947-1 and IEC 60529 / EN 60529 | | | | | | | | | | | | |
| Main terminals | | IP20 | | | | | | IP10 | | | | |
| Coil terminals | | IP20 | | | | | | | | | | |
| Built-in auxiliary terminals | | IP20 | | | | | | | | | | |
| Screw terminals | | Delivered in open position, screws of unused terminals must be tightened | | | | | | | | | | |
| Main terminals | | M3.5 | | | M4 | | | M6 | | M8 | | |
| | Screwdriver type | Flat \varnothing 5.5 / Pozidriv 2 | | | Flat \varnothing 6.5 / Pozidriv 2 | | | | | hexagon socket (s = 4 mm) | | |
| Coil terminals | | M3.5 | | | | | | | | | | |
| | Screwdriver type | Flat \varnothing 5.5 / Pozidriv 2 | | | | | | | | | | |
| Built-in auxiliary terminals | | M3.5 | | | | | | | | | | |
| | Screwdriver type | Flat \varnothing 5.5 / Pozidriv 2 | | | | | | | | | | |

AFS116 ... AFS370 3-pole contactors for safety applications

Technical data

Connecting characteristics

| Contactor types | AC / DC operated | AFS116 | AFS146 | AFS190 | AFS205 | AFS265 | AFS305 | AFS370 |
|---|------------------|---|--------|---|--------|---|--------|--------|
| Main terminals Flat type | |  | |  | |  | | |
| Connection capacity (min. ... max.) | | | | | | | | |
| Main conductors (poles) | | | | | | | | |
|  Cu cable - Stranded | 1 x | 10...95 mm ² | | 6...150 mm ² | | 16...300 mm ² | | |
| Clamp type | | LD... included (1) | | 1SDA066917R1 | | 1SDA055016R1 | | |
| Tightening torque | | 8 Nm | | 14 Nm | | 25 Nm | | |
|  Cu cable - Stranded | 2 x | 10...95 mm ² | | 50...120 mm ² | | 70...185 mm ² | | |
| Clamp type | | LD... included (1) | | 1SFN074709R1000, LZ185-2C/120 | | 1SCA022194R0890, OZXB4 | | |
| Tightening torque | | 8 Nm | | 16 Nm | | 22 Nm | | |
|  Al cable - Stranded | 1 x | - | | 95...185 mm ² | | 185...240 mm ² | | |
| Clamp type | | - | | 1SDA054988R1 | | 1SDA055020R1 | | |
| Tightening torque | | - | | 31 Nm | | 43 Nm | | |
|  Cu cable - Flexible | 1 x | 10...70 mm ² | | 6...120 mm ² | | 16...240 mm ² | | |
| Clamp type | | LD... included (1) | | 1SDA066917R1 | | 1SDA055016R1 | | |
| Tightening torque | | 8 Nm | | 14 Nm | | 25 Nm | | |
|  Cu cable - Flexible | 2 x | 10...70 mm ² | | 50...95 mm ² | | 70...185 mm ² | | |
| Clamp type | | LD... included (1) | | 1SFN074709R1000, LZ185-2C/120 | | 1SCA022194R0890, OZXB4 | | |
| Tightening torque | | 8 Nm | | 16 Nm | | 22 Nm | | |
|  Lugs | L ≤ | 22 mm (.866 in) | | 24 mm (.945 in) | | 32 mm (1.260 in) | | |
| | Ø > | 6 mm (.236 in) | | 8 mm (.315 in) | | 10 mm (.394 in) | | |
| Socket type | | LL... included | | LL... included | | LL... included | | |
| Tightening torque | | 9 Nm / 80 lb.in | | 18 Nm / 160 lb.in | | 28 Nm / 248 lb.in | | |
| Connection capacity acc. to UL / CSA | 1 x | AWG 6...3/0 | | 6...300 MCM | | 4...400 MCM | | |
| Clamp type | | LD... included (1) | | ATK185 (2) | | ATK300 (2) | | |
| Tightening torque | | 8 Nm / 71 lb.in | | 34 Nm / 301 lb.in | | 42 Nm / 372 lb.in | | |
| Connection capacity acc. to UL / CSA | 2 x | AWG 6...3/0 | | - | | 4...500 MCM | | |
| Clamp type | | LD... included (1) | | - | | ATK300/2 (2) | | |
| Tightening torque | | 8 Nm / 71 lb.in | | - | | 42 Nm / 372 lb.in | | |
| Auxiliary conductors (coil terminals) | | | | | | | | |
|  Solid / stranded | 1 x | 1...4 mm ² | | | | | | |
| | 2 x | 1...4 mm ² | | | | | | |
|  Flexible | 1 x | 0.75...2.5 mm ² | | | | | | |
| | 2 x | 0.75...2.5 mm ² | | | | | | |
|  Flexible with non insulated ferrule | 1 x | 0.75...2.5 mm ² | | | | | | |
| | 2 x | 0.75...2.5 mm ² | | | | | | |
|  Flexible with insulated ferrule | 1 x | 0.75...2.5 mm ² | | | | | | |
| | 2 x | 0.75...2.5 mm ² | | | | | | |
|  Lugs | L < | 8 mm | | | | | | |
| | I > | 3.5 mm | | | | | | |
| Connection capacity acc. to UL / CSA | 1 or 2 x | AWG 18...14 | | | | | | |
| Stripping length | | 9 mm | | | | | | |
| Tightening torque | | 1.00 Nm / 9 lb.in | | | | | | |
| Degree of protection acc. to IEC 60947-1 / EN 60947-1 and IEC 60529 / EN 60529 | | | | | | | | |
| Main terminals | | IP00 | | | | | | |
| Coil terminals | | IP20 | | | | | | |
| Screw terminals | | | | | | | | |
| Main terminals | | M6 | | M8 | | M10 | | |
| Screwdriver type | | Screws and bolts | | | | | | |
| Coil terminals (delivered in open position) | | M3.5 | | | | | | |
| Screwdriver type | | Flat Ø 5.5 mm / Pozidriv 2 | | | | | | |











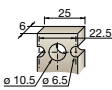
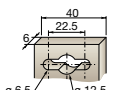



(1) LD... not included for AFS116 ... AFS146-30...B.

(2) Available in North America only.

AFS400 ... AFS750 3-pole contactors for safety applications

Technical data

Connecting characteristics

| Contactor types | AC / DC operated | AFS400 | AFS460 | AFS580 | AFS750 |
|---|-------------------------------------|---|----------------------------------|---|--------|
| Main terminals | | | | | |
| Flat type | | | | | |
| | |  | |  | |
| Connection capacity (min. ... max.) | | | | | |
| Main conductors (poles) | | | | | |
|  | Cu cable - Stranded | 2 x | 240 mm ² | | - |
| | Clamp type | | 1SDA013922R1 | | - |
| | Tightening torque | | 35 Nm | | - |
|  | Cu cable - Stranded | 3 x | - | 185 mm ² | |
| | Clamp type | | - | 1SDA013956R1 | |
| | Tightening torque | | 35 Nm | 45 Nm | |
|  | Al cable - Stranded | 2 x | 240 mm ² | | - |
| | Clamp type | | 1SDA013922R1 | | - |
| | Tightening torque | | 35 Nm | | - |
|  | | 3 x | - | 185 mm ² | |
| | Clamp type | | - | 1SDA013956R1 | |
| | Tightening torque | | 35 Nm | 45 Nm | |
|  | Lugs | L ≤ | 47 mm | 50 mm | |
| | | Ø > | 10 mm | 12 mm | |
| | Tightening torque | | 35 Nm / 310 lb.in | 45 Nm / 398 lb.in | |
| Connection capacity acc. to UL / CSA | | | | | |
| | | 2 x | 250-500 MCM alt. 2/0 AWG-500 MCM | | - |
| | Clamp type | | K6TH alt. ATK580 | | - |
| | Tightening torque | | 275 lb.in | | - |
| Connection capacity acc. to UL / CSA | | | | | |
| | | 3 x | 2/0 AWG-400 MCM | 2/0 AWG-500 MCM | |
| | Clamp type | | K6TJ | ATK750/3 | |
| | Tightening torque | | 275 lb.in | 375 lb.in | |
| Auxiliary conductors (coil terminals) | | | | | |
|  | Solid / stranded | 1 x | 1...4 mm ² | | |
|  | | 2 x | 1...4 mm ² | | |
|  | Flexible | 1 x | 0.75...2.5 mm ² | | |
|  | | 2 x | 0.75...2.5 mm ² | | |
|  | Flexible with non insulated ferrule | 1 x | 0.75...2.5 mm ² | | |
|  | | 2 x | 0.75...2.5 mm ² | | |
|  | Flexible with insulated ferrule | 1 x | 0.75...2.5 mm ² | | |
|  | | 2 x | 0.75...2.5 mm ² | | |
|  | Lugs | L ≤ | 8 mm | | |
| | | L > | 3.7 mm | | |
| Connection capacity acc. to UL / CSA | | | | | |
| | | 1 or 2 x | AWG 18...14 | | |
| Tightening torque | | | | | |
| | Recommended | | 1.00 Nm / 9 lb.in | | |
| | Max. | | 1.20 Nm | | |
| Degree of protection acc. to IEC 60947-1 / EN 60947-1 and IEC 60529 / EN 60529 | | | | | |
| Main terminals | | | | | |
| Coil terminals | | | | | |
| IP00 | | | | | |
| IP20 | | | | | |
| Screw terminals | | | | | |
| Main terminals | | | | | |
| M10 | | | | | |
| Screws and bolts | | | | | |
| M12 | | | | | |
| Coil terminals (delivered in open position) | | | | | |
| M3.5 | | | | | |
| Screwdriver type | | | | | |
| Flat Ø 5.5 mm / Pozidriv 2 | | | | | |

AFS09 ... AFS96 3-pole contactors for safety applications

Technical data

Built-in auxiliary contacts according to IEC

| Contactor types | AC / DC operated | AFS09 | AFS12 | AFS16 | AFS26 | AFS30 | AFS38 | AFS40 | AFS52 | AFS65 | AFS80 | AFS96 |
|--|--------------------|--|-------|-------|-------|-------|-------|-------|-------|-------|-------|-------|
| Rated operational voltage Ue max. | | 690 V | | | | | | | | | | |
| Rated frequency (without derating) | | 50 / 60 Hz | | | | | | | | | | |
| Conventional free air thermal current Ith - θ ≤ 40 °C | | 16 A | | | | | | | | | | |
| le / Rated operational current AC-15 | | | | | | | | | | | | |
| acc. to IEC 60947-5-1 | 24-127 V 50/60 Hz | 6 A | | | | | | | | | | |
| | 220-240 V 50/60 Hz | 4 A | | | | | | | | | | |
| | 400-440 V 50/60 Hz | 3 A | | | | | | | | | | |
| | 500 V 50/60 Hz | 2 A | | | | | | | | | | |
| | 690 V 50/60 Hz | 2 A | | | | | | | | | | |
| Making capacity AC-15 | | 10 x le AC-15 acc. to IEC 60947-5-1 | | | | | | | | | | |
| Breaking capacity AC-15 | | 10 x le AC-15 acc. to IEC 60947-5-1 | | | | | | | | | | |
| le / Rated operational current DC-13 | | | | | | | | | | | | |
| acc. to IEC 60947-5-1 | 24 V DC | 6 A / 144 W | | | | | | | | | | |
| | 48 V DC | 2.8 A / 134 W | | | | | | | | | | |
| | 72 V DC | 1 A / 72 W | | | | | | | | | | |
| | 110 V DC | 0.55 A / 60 W | | | | | | | | | | |
| | 125 V DC | 0.55 A / 69 W | | | | | | | | | | |
| | 220 V DC | 0.27 A / 60 W | | | | | | | | | | |
| | 250 V DC | 0.27 A / 68 W | | | | | | | | | | |
| | 400 V DC | 0.15 A / 60 W | | | | | | | | | | |
| | 500 V DC | 0.13 A / 65 W | | | | | | | | | | |
| | 600 V DC | 0.1 A / 60 W | | | | | | | | | | |
| Short-circuit protection device gG type fuse | | 10 A | | | | | | | | | | |
| Rated short-time withstand current Icw | for 1.0 s | 100 A | | | | | | | | | | |
| | for 0.1 s | 140 A | | | | | | | | | | |
| Minimum switching capacity with failure rate acc. to IEC 60947-5-4 | | 12 V / 3 mA | | | | | | | | | | |
| | | 10 ⁻⁷ | | | | | | | | | | |
| Non-overlapping time between N.O. and N.C. contacts | | ≥ 2 ms | | | | | | | | | | |
| Power dissipation per pole at 6 A | | 0.1 w | | | | | | | | | | |
| Maximum electrical switching frequency | AC-15 | 1200 cycles/h | | | | | | | | | | |
| | DC-13 | 900 cycles/h | | | | | | | | | | |
| Mechanically linked contacts acc. to annex L of IEC 60947-5-1 | | Built-in N.O. or N.C. auxiliary contacts and additional N.O. or N.C. auxiliary contacts (CAL4 aux. contact blocks) are mechanically linked contacts. | | | | | | | | | | |
| Mirror contacts acc. to annex F of IEC 60947-4-1 | | Built-in N.C. auxiliary contacts or additional N.C. auxiliary contacts (CAL4 aux. contact blocks) are mirror contacts. | | | | | | | | | | |

Built-in auxiliary contacts according to UL / CSA

| Contactor types | AC / DC operated | AFS09 | AFS12 | AFS16 | AFS26 | AFS30 | AFS38 | AFS40 | AFS52 | AFS65 | AFS80 | AFS96 |
|--|------------------|--------------------|-------|-------|-------|-------|-------|-------|-------|-------|-------|-------|
| Maximum operational voltage | | 600 V AC, 600 V DC | | | | | | | | | | |
| Pilot duty | | A600, Q600 | | | | | | | | | | |
| AC thermal rated current | | 10 A | | | | | | | | | | |
| AC maximum volt-ampere making | | 7200 VA | | | | | | | | | | |
| AC maximum volt-ampere breaking | | 720 VA | | | | | | | | | | |
| DC thermal rated current | | 2.5 A | | | | | | | | | | |
| DC maximum volt-ampere making-breaking | | 69 VA | | | | | | | | | | |

AFS09 ... AFS750 3-pole contactors for safety applications

Terminal marking and positioning

AFS09 ... AFS96 contactors - AC / DC operated

Standard devices

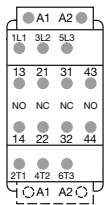

AFS09 ... AFS16...-30-22

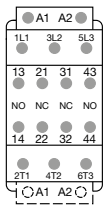

AFS26 ... AFS96...-30-22

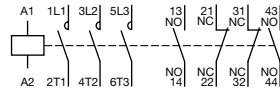

AFS09 ... AFS96...-30-22

AFS116 ... AFS370 contactors - AC / DC operated

Standard devices with factory mounted auxiliary contacts

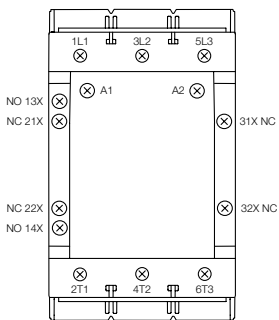

AFS116 ... AFS370-30-12

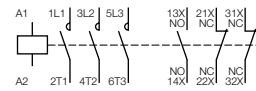

AFS116 ... AFS370-30-12

AFS400 ... AFS750 contactors - AC / DC operated

Standard devices with factory mounted auxiliary contacts

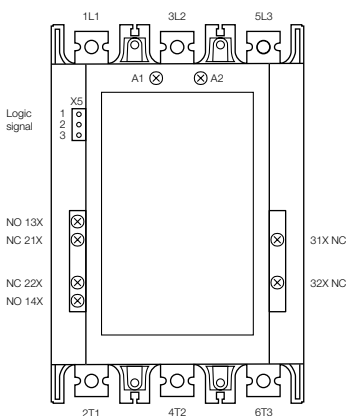

AFS400 ... AFS750-30-12

Control with logic signal

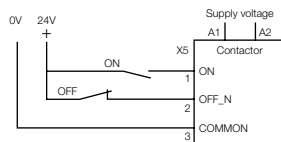

AFS400 ... AFS750-30-12

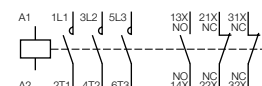

AFS400 ... AFS750-30-12

3-pole contactors

Electrical durability and utilization categories

General

Utilization categories determine the current making and breaking conditions relating to the characteristics of the loads to be controlled by the contactors. International standard IEC 60947-4-1 and European standard EN 60947-4-1 are the standards to be referred to.

If I_c is the current to be broken by the contactor and I_e the rated operational current normally drawn by the load, then:

- Categories AC-1 and AC-3: $I_c = I_e$
- Category AC-2: $I_c = 2.5 \times I_e$
- Category AC-4: $I_c = 6 \times I_e$

Generally speaking $I_c = m \times I_e$ where m is a multiple of the load operational current.

On next pages, the curves corresponding to categories AC-1, AC-3 and AC-4 represent the electrical durability variation of standard contactors in relation to the breaking current I_c .

Electrical durability is expressed in millions of operating cycles.

Curve utilization mode

Electrical durability forecast and contactor selection for categories AC-1, AC-2, AC-3 or AC-4

- Note the characteristics of the load to be controlled:
 - Operational voltage U_e
 - Current normally drawn I_e ($U_e / I_e / kW$ relation for motors, see "Motor rated operational powers and currents").
 - Utilization category AC-1, AC-2, AC-3 or AC-4
 - Breaking current $I_c = I_e$ for AC-1 and for AC-3 ; $I_c = 2.5 \times I_e$ for AC-2 ; $I_c = 6 \times I_e$ for AC-4
- Define the number of operating cycles N required.
- On the diagram corresponding to the operational category, select the contactor with the curve immediately above the intersection point ($I_c ; N$).

Electrical durability forecast and contactor selection for mixed duty motor control: AC-3 ($I_c = I_e$) type switching off while "motor running" and, occasionally, AC-4 ($I_c = 6 \times I_e$) type switching off while "motor accelerating"

- Note the characteristics of the motor to be controlled:
 - Operational voltage U_e
 - Current normally drawn while "motor running" I_e ($U_e / I_e / kW$ relation for motors, see "Motor rated operational powers and currents")
 - Breaking current for AC-3 $I_c = I_e$
 - Breaking current for AC-4 while "motor accelerating" $I_c = 6 \times I_e$
 - Percentage of AC-4 operating cycles K (on the basis of the total number of operating cycles)
- Define the total number of operating cycles N required.
- Note the smallest contactor rating compatible for AC-3 (U_e / I_e) on Main pole utilization characteristic table (see "Technical data").
- For the selected contactor make a note of the following in relation to the voltage using diagram AC-3 in next pages:
 - The number of operating cycles A for $I_c = I_e$ (AC-3)
 - The number of operating cycles B for $I_c = 6 \times I_e$ (AC-4)
- Calculate the estimated number of cycles N' (N' is always below A)

$$N' = \frac{A}{1 + 0.01 K (A/B - 1)}$$

- If N' is too low in relation to the target N , calculate the estimated number of cycles for a higher contactor rating.

Case of uninterrupted duty

For uninterrupted duty, some verifications of preventing maintenance are necessary to check the functionality of the concerned product (consult us).

The combined effect of environmental conditions and the proper temperature of the product may require some disposals. As a matter of fact, for this duty, the use duration prevails over the number of operating cycles.

3-pole contactors for safety applications

Electrical durability

Electrical durability for AC-1 utilization category - $U_e \leq 690\text{ V}$

Switching non-inductive or slightly inductive loads. The breaking current I_c for AC-1 is equal to the rated operational current of the load.

Ambient temperature and maximum electrical switching frequency: see "Technical data".

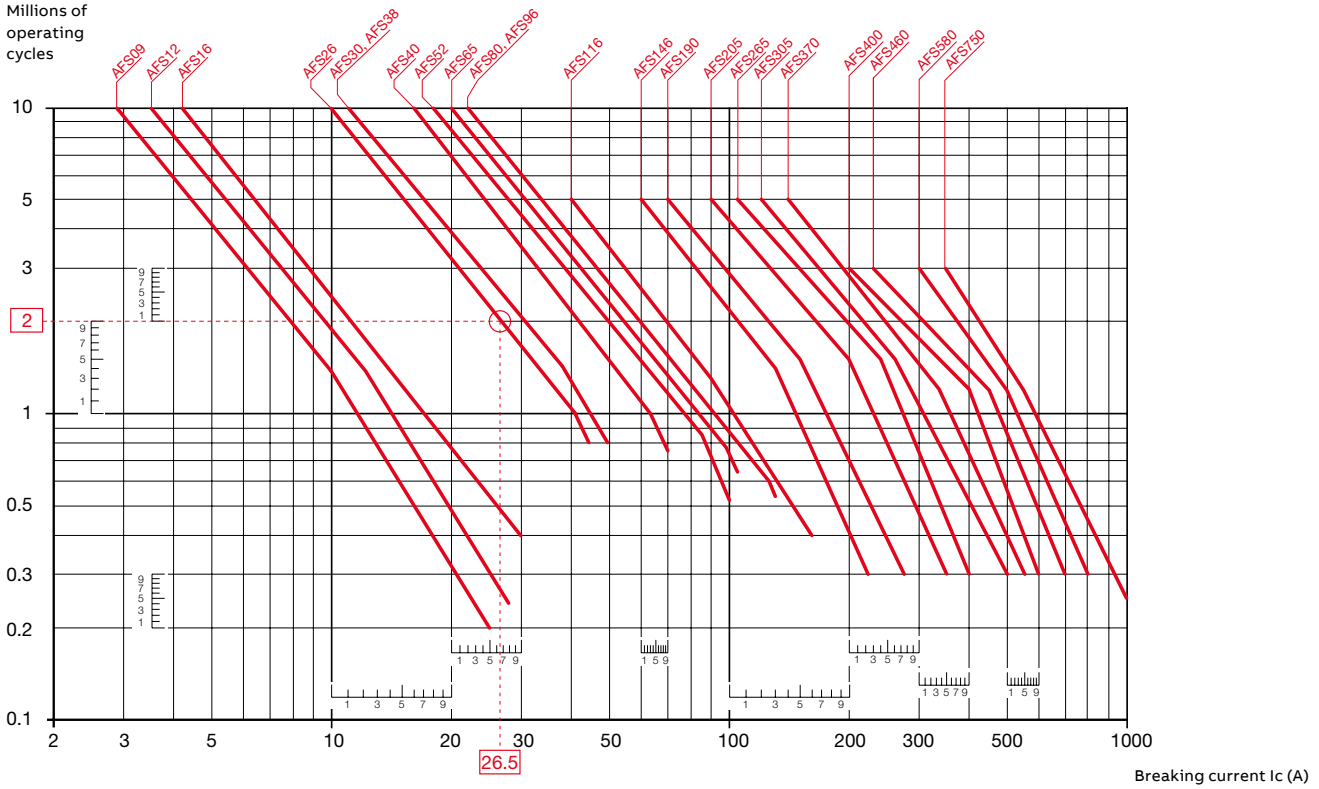

Example:

$I_c / AC-1 = 26.5\text{ A}$ – Electrical durability required = 2 millions operating cycles.

Using the AC-1 curves above select the AFS26 contactor at intersection "O" (26.5 A / 2 millions operating cycles).

3-pole contactors for safety applications

Electrical durability

Electrical durability for AC-3 utilization category - $U_e \leq 440$ V.

Switching cage motors: starting and switching off running motors. The breaking current I_c for AC-3 is equal to the rated operational current I_e (I_e = motor full load current).

Ambient temperature and maximum electrical switching frequency: see "Technical data".

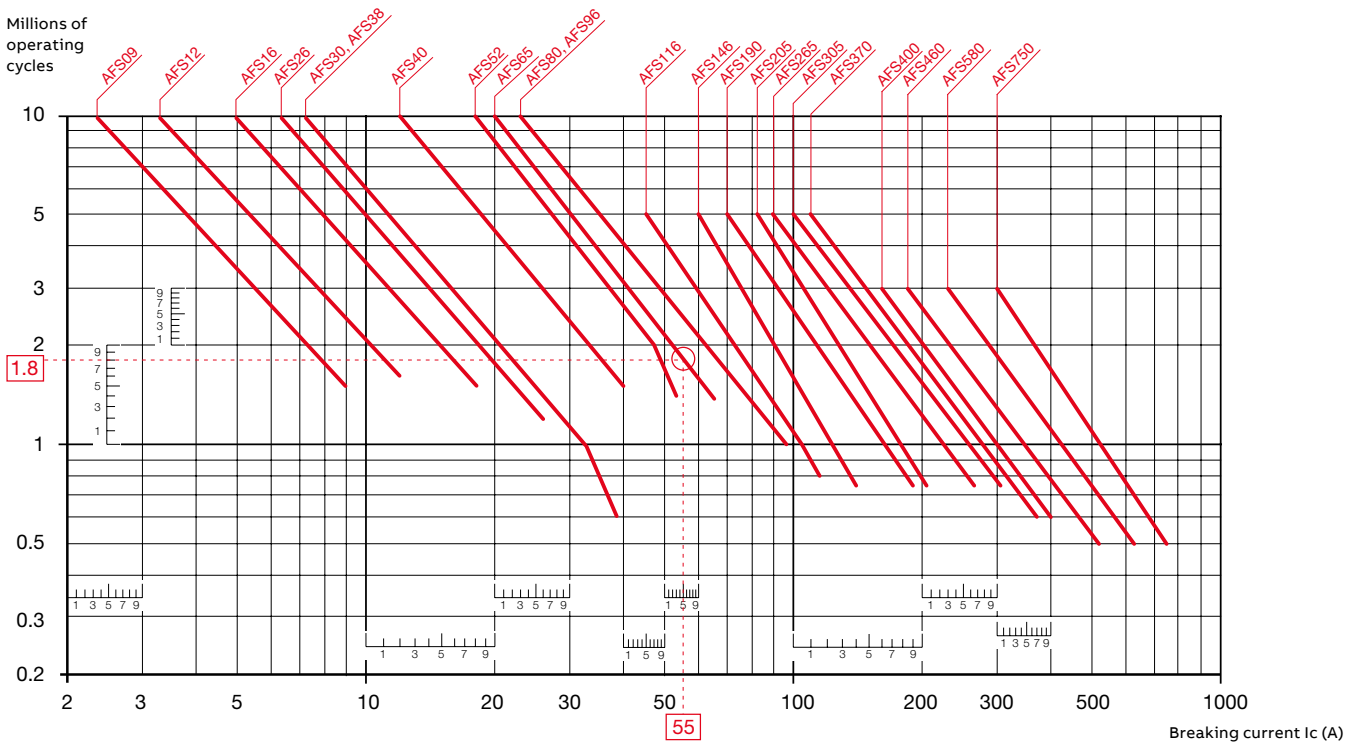

Example:

Motor power 30 kW for AC-3 - $U_e = 400$ V and $I_e = 55$ A utilization – Electrical durability required = 1.8 million operating cycles. For AC-3: $I_c = I_e$. Select the AFS65 contactor at intersection "O" (55 A / 1.8 million operating cycles) on the curves (AC-3 - $U_e \leq 440$ V).

3-pole contactors for safety applications

Electrical durability

Electrical durability for AC-3 utilization category - 440 V < Ue ≤ 690 V.

Switching cage motors: starting and switching off running motors. The breaking current I_c for AC-3 is equal to the rated operational current I_e (I_e = motor full load current).

Ambient temperature and maximum electrical switching frequency: see "Technical data".

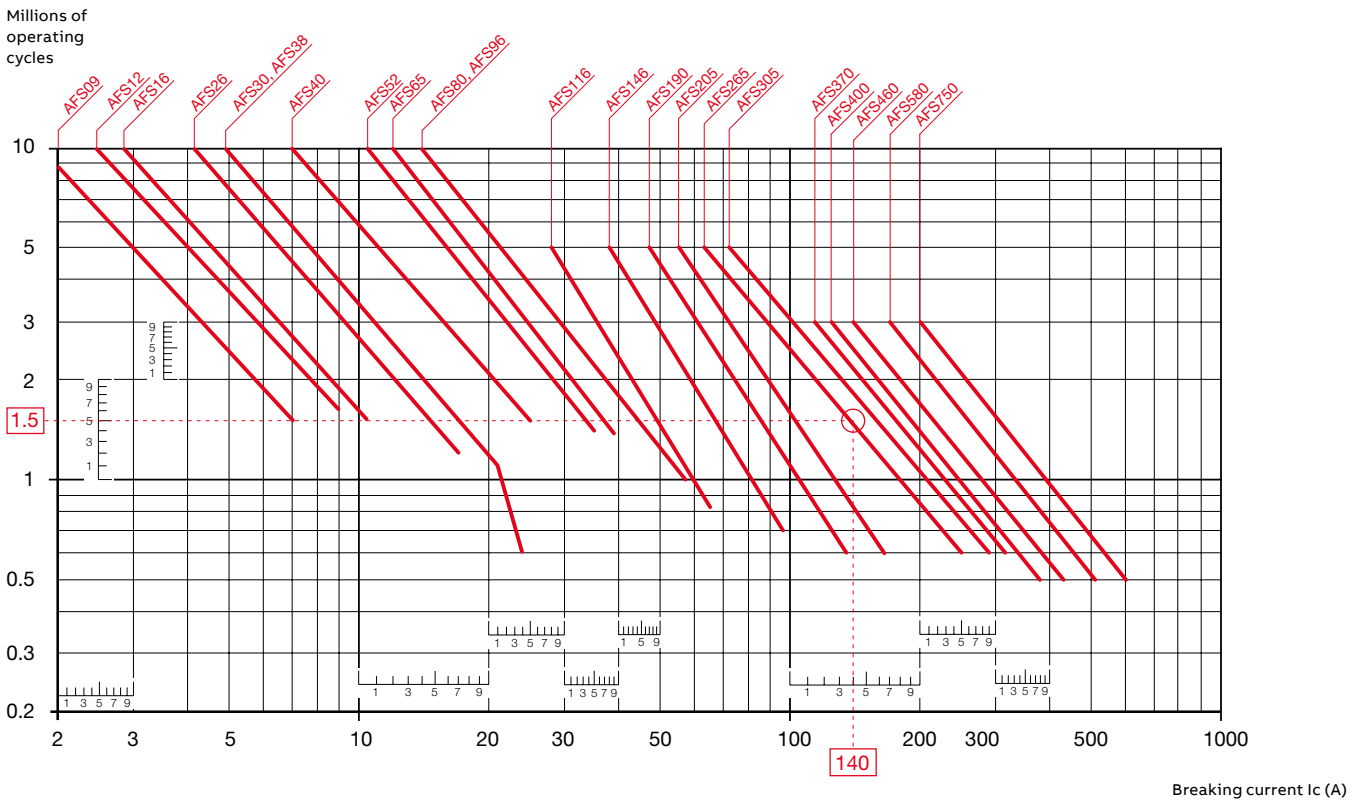

3-pole contactors for safety applications

Electrical durability

Electrical durability for AC-2 or AC-4 utilization category - $U_e \leq 440\text{ V}$

Ambient temperature $\leq 60\text{ °C}$ for AFS09 ... AFS96

Switching cage motors: starting, reverse operation and step-by-step operation. The breaking current I_c is equal to $2.5 \times I_e$ for AC-2 and $6 \times I_e$ for AC-4, keeping in mind that I_e is the motor rated operational current (I_e = motor full-load current).
Maximum electrical switching frequency: see "Technical data".

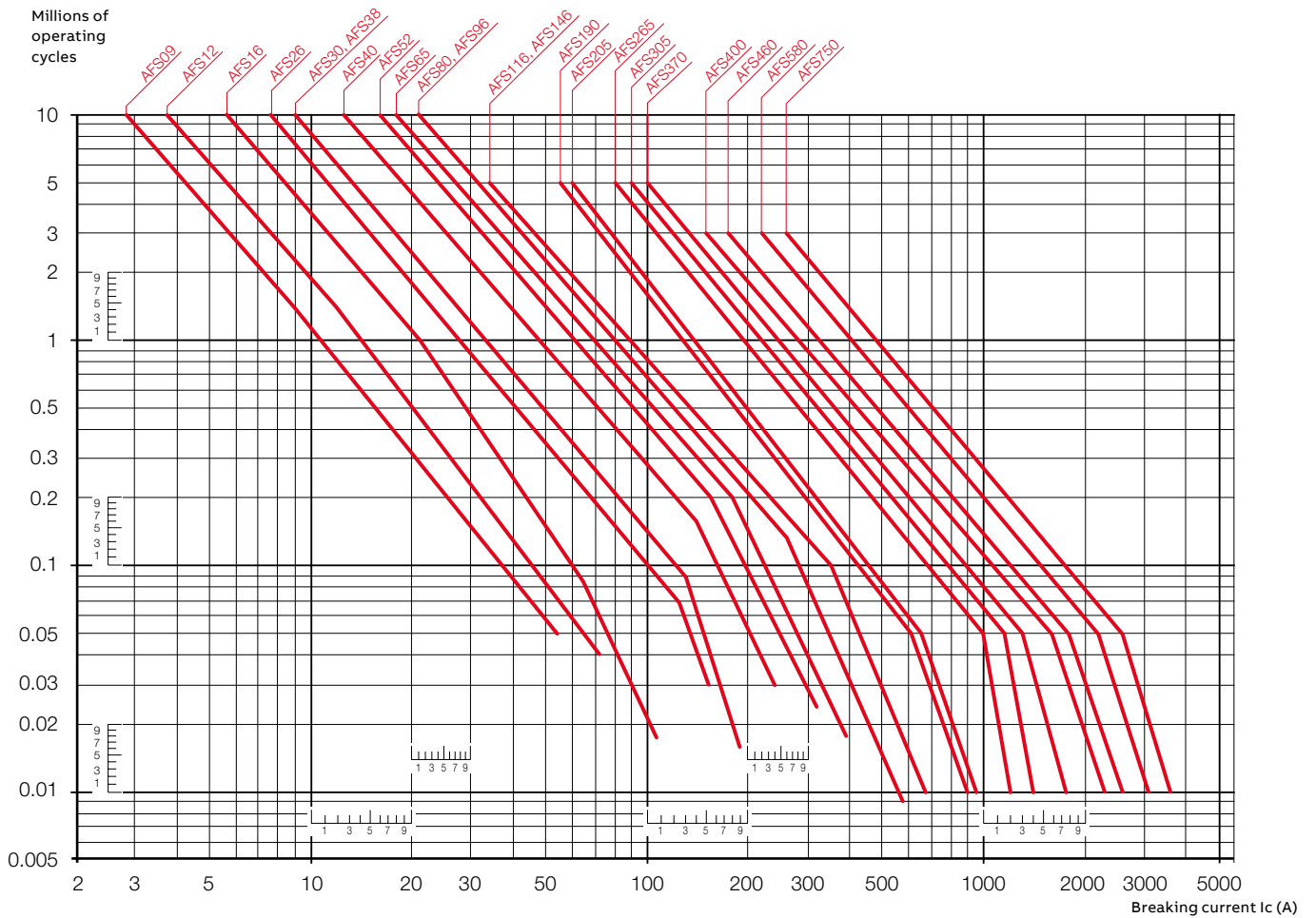

3-pole contactors for safety applications

Electrical durability

Electrical durability for AC-2 or AC-4 utilization category - 440 V < Ue ≤ 690 V

Ambient temperature ≤ 60 °C for AFS09 ... AFS96

Switching cage motors: starting, reverse operation and step-by-step operation. The breaking current I_c is equal to $2.5 \times I_e$ for AC-2 and $6 \times I_e$ for AC-4, keeping in mind that I_e is the motor rated operational current (I_e = motor full load current).

Maximum electrical switching frequency: see "Technical data".





ABB France

Electrification Products Division

Low Voltage Products and Systems

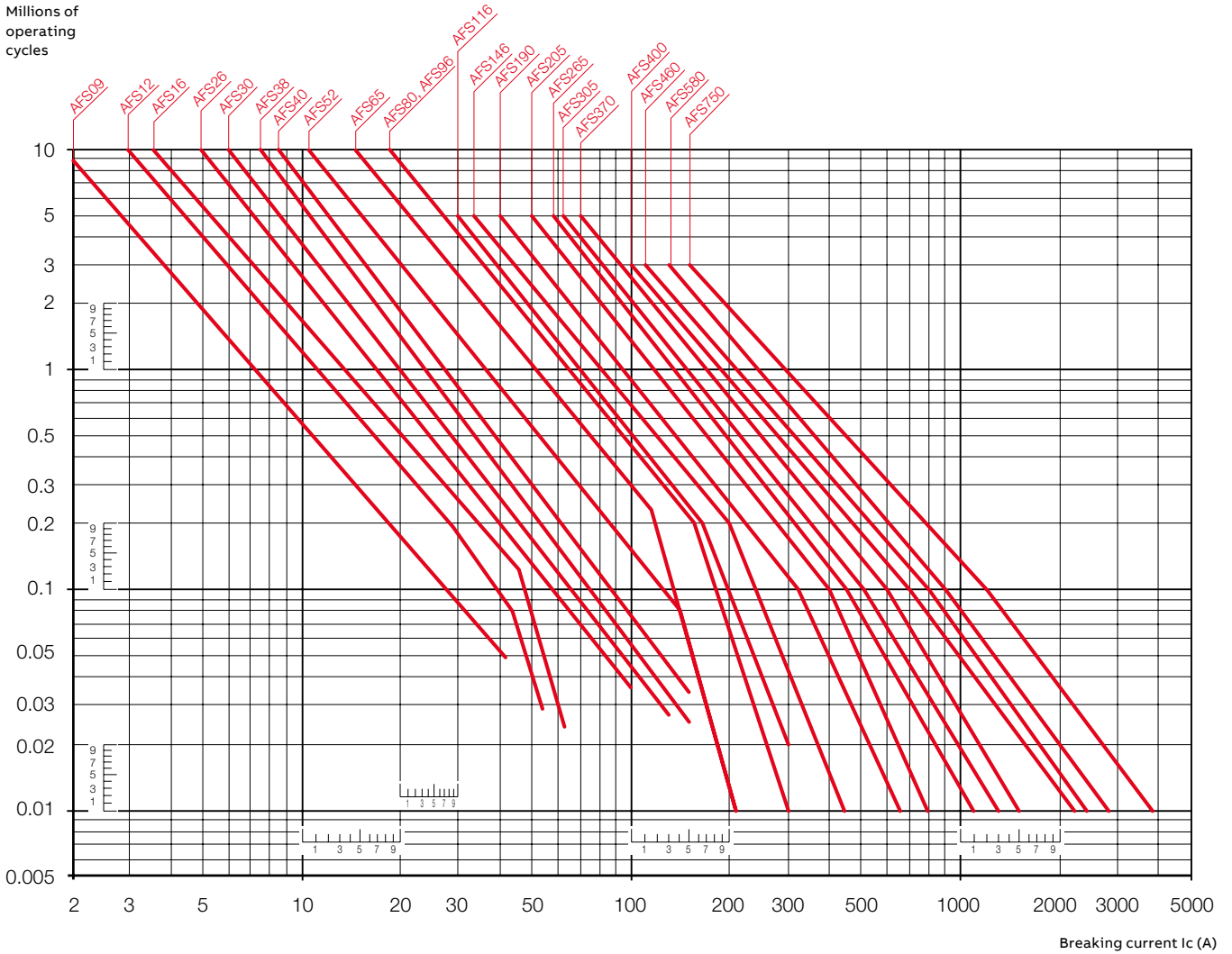
3, rue Jean Perrin

F-69687 Chassieu cedex / France

**You can find the address of your local sales organization
on the ABB home page**



<http://new.abb.com/low-voltage>



<http://new.abb.com/low-voltage/products/connection-devices>

We reserve the right to make technical changes or modify the contents of this document without prior notice. ABB does not accept any responsibility whatsoever for potential errors or possible lack of information in this document.

We reserve all rights in this document and in the subject matter and illustrations contained therein. Any reproduction, disclosure to third parties or utilization of its contents – in whole or in parts – is forbidden without prior written consent of ABB.

Copyright© 2019 ABB - All rights reserved