

Variable Frequency Drives

SJ series **P1**

Intuitively innovative!



At the point where ease of use meets high performance

BE THE NEXT STANDARD

P1



Powerful and

SJ series P1, setting the new global standard

1. Easy access to all the functions

▶ P.3-6

The intuitive color LCD operator and various convenient features.

2. A High Performance drive for the most demanding applications

▶ P.7-8

A variety of motors (IM/PM) can be adjustable to drive.
The most stable operation ever.

3. Versatility through multi mode operation, to meet your specific application needs

▶ P.9-10

SJ series P1 meets a wide range of needs in various situation.
SJ series P1 has a variety of functions for drive systems.

Corresponds to variety of applications.



Fan

▶ P.11



Pump

▶ P.11



Crane

▶ P.13



Conveyor

▶ P.7



Injection molding

▶ P.13

Accessible

Color LCD Operator

P.3

Option slots P.10, 51, 52, 53

USB connector for Inverter Configuration Software (ProDriveNext)

P.15-16



Control Circuit terminals

P.6, 29, 30

Main circuit terminals.

P.28



CONTENTS

Features	P.3-18
Model configuration	P.19
Standard Specifications	P.20-21
Common specifications	P.22-23
Protective Functions	P.24
Dimensions	P.25-29
Terminals	P.30-32
Connecting Diagram	P.33
Connecting to PLC	P.34
Function List	P.35-50
Wiring and Accessories	P.51-52
Option cassette	P.53-55
Torque Characteristic	P.56
Compatibility Between SJ700series and SJ Series P1	P.57-58
Current Derating	P.59-60
For Correct Operation	P.61-62



Winder & re-winder

P.14



Machine tool

P.14

Corresponding to the global standard.
The input voltage is 500 VAC maximum.
(400V class)



P.10



JQA-1153
JQA-EM6974

Hitachi Industrial Equipment Systems Co., Ltd. NARASHINO division is certified for ISO 14001 (standard of environmental management system) and ISO 9001 (standard of quality assurance management system).



Intuitive, easy-to-use color LCD operator is standard

Easy to monitor, set and review operational data and parameters.

● Color LCD Operator Description

MONITOR SCREEN

Displays parameters and data.

F1 KEY

Transition to home, cancel, etc.

POWER LED

Turns ON while the operator is powered-on.

RUN KEY

Motor starts rotation when this Key is active.

User-friendly display



Monitor display example

F2 KEY

Save data, etc.
User defined function of the key is indicated at the bottom right of the screen.

RUN LED

Turns ON while in RUN mode.

STOP / RESET KEY

Decelerate to stop, Reset the tripping.

UP/DOWN/LEFT/RIGHT KEYS & SEL KEY (CENTER)

To move between the screen/data, use UP/DOWN/LEFT/RIGHT.
To select the data, press the SEL key.

● Features of Color LCD Operator

"Visualization Icon"

Easy to understand the inverter status

RUN, STOP, TRIP, OVERLOAD, FAN LIFE NOTICE and others are very obvious. For this Icon, error diagnosis is also easy.

Examples of "Operation visualization icon"

	The motor is in forward running.		Output frequency is limited by such as overload.
	The motor is in reverse running.		The inverter is in overload notice or thermal notice.
	Inverter is in trip status.		The inverter can not be operated in the RUN command.
	Operation command is entered, but the inverter is forced stop.		The inverter is in Fan life notice state.
	The inverter is stopped, because Operation command is OFF.		The inverter is in Capacitor life notice state.

Background color can be selected

Selectable from Blue / Green / Black. Easy visualization can be achieved in every cases!



Monitor display example

"Setting visualization icon"

Easy to see which screen you set on.

Large character display

Great visibility by the large character display.

Assist bar

Indicating functions of F1, F2 and RUN key to assist your operation. Also, the time information can be shown in this area.

Real-time at the alarm occurrence is recorded.

Alarm record available based on Real-time-clock. Date and time can be set in LCD Operator by placing battery. This helps with speedy fault diagnosis and root cause investigation.

(Note: A battery needs to be prepared separately.)

Multiple languages.

The display is available in 10 languages (Japanese, English, French, Spanish, Turkish, Polish, Czech, German, Italian, Dutch) as standard.

(Note: Firmware version of LCD Operator (VOP) that can display 10 languages is 2.02 or later. (VOP version can be confirmed with the nameplate seal on the back of LCD Operator.)

- Version UP** Improvements or added items
- EzSQ** EzSQ application cases. refer to P17-18 for details.
- PM motor** PM motor specific functions.

● Example of main screen transition and parameter setting

Check at once!

Quick View



Multi-monitor (3lines)

Monitor while setting!

Verify View



Reference screen

Easy to see!

Clear View



Large monitor screen

Quick trouble-shooting!

Error View



Trip history screen

Intuitive scroll mode!
It is easy to access the parameters you want to set.



Scroll menu



Select change parameter

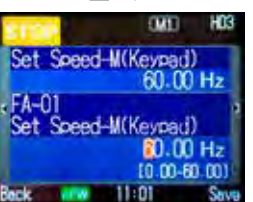

Select the setting value with the arrow keys

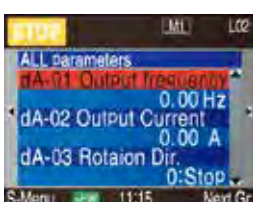

ALL parameters

Other features!

- Parameter data can be saved in the memory of LCD Operator! Data can be kept safe even if the inverter fails.
- LCD Operator can be also used as copy unit!
- Putting a battery, the real-time data will remain even the power is cut off.
- LCD Operator can be remotely connected via option cable ICS-1 or ICS-3.



(Note) While the power is supplied, please do not remove LCD Operator!

● Trip monitor

- Display of former models
- Inverter state is easy to understand when an error has occurred.

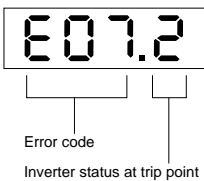

Error code
Inverter status at trip point

→

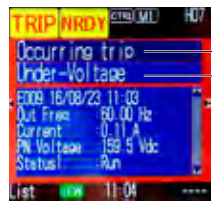

Shown the **inverter is in trip condition.**
Shows the **cause of trip.**
Displays trip information:
Output frequency at trip point/Motor current at trip point/
DC bus voltage at trip point/Cumulative inverter operation/
Cumulative power-ON time at trip point.

Scroll



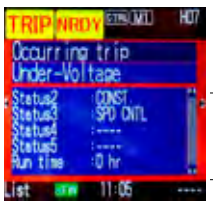

Status 1 to 5 indicates the inverter state at the time of the trip occurs.
(Note) Please refer to User's guide for more information.

(Note) These display is a state of the moment of error occurrence, the actual motor behavior might be different.

Various convenient features.



Direct field replacement

Cabinet mounting portion is supplied as separate part. (5.5kW or more)
Even if its body size is different, it is possible to correspond in flexible ways.

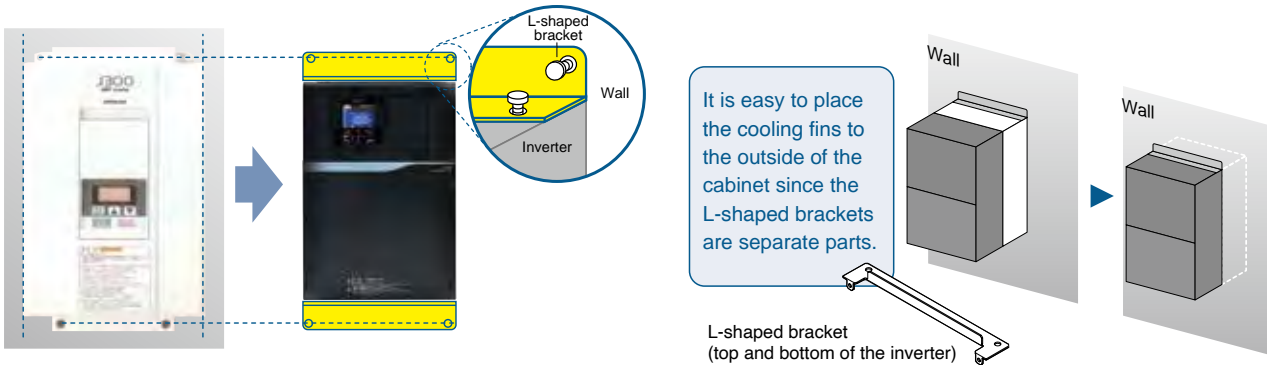

Support the replacement from previous series.

•Optional screw type terminal block is available by removing the standard terminal block.

Note: Removable terminal blocks of SJ300/L300P/SJ700/L700 cannot be mounted on a SJ series P1 inverter.

•Data conversion can be made via Inverter Configuration Software (ProDriveNext).

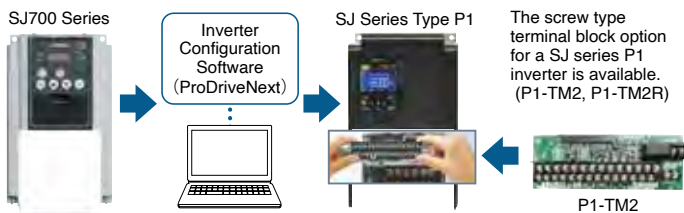

Cooling fan and the main circuit capacitor is designed for 10 years life.

(Note: The ambient temperature is 40 °C (annual average).
 Without corrosive gas, flammable gas, oil mist and dust.)
 The above design life is a calculated value, not a guaranteed value.
 Output current at the calculation is 80% of the rated current of the inverter.)

Monitor lifetime prediction functions.

Electrolytic capacitor of control circuit
 (internal estimation calculation).
 Cooling fan.

Easy data copy to multiple inverters.

LCD Operator is removable and memory is built in.
 Parameter data and EzSQ programming data can be copied to multiple inverters, which allows users to replace inverter in a short working time.

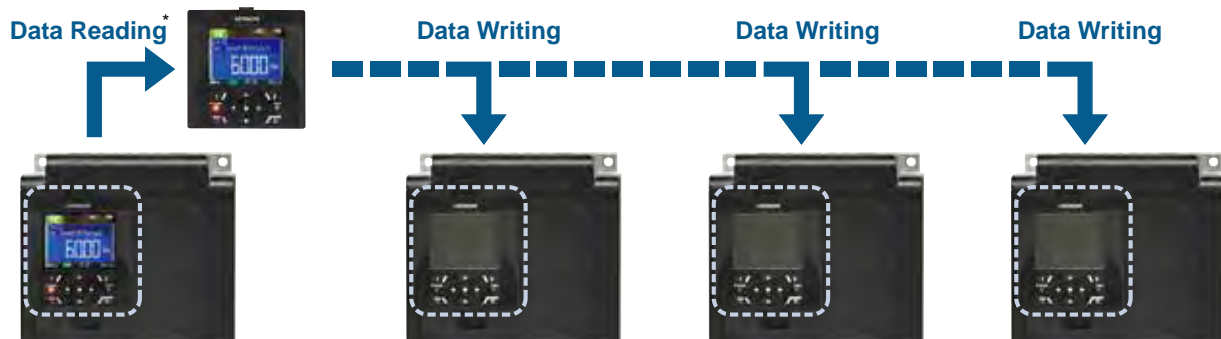

*Cannot be read in case of inverter failure.

- version UP** Improvement or added item.
- EzSQ** EzSQ application case, refer to P17-18 for details.
- PM motor** PM motor specific function.

Control circuit terminal designed for easy wiring

version UP

The screw-less terminal block makes wiring easier.

Rod terminal achieved easy wiring.



Modbus communication is standard. 2 communication terminals are provided for Modbus communication as standard.

It makes daisy chain wiring of RS-485 easy.



0/10V and 4 to 20mA inputs and as well as output are easily selected via DIP switch.

- 2 analog inputs (3 inputs in total).
- 2 analog outputs.

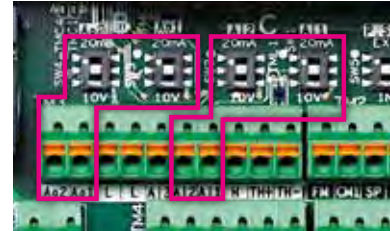

Save time and energy with 24 VDC control power supply

version UP

In addition to a normal power supply (R0, T0), an external 24 VDC control power supply is also available.

Parameter setting is possible without main power to save time and effort. The reduction of standby power will also contribute to energy conservation.

Connecting to the PLC and setting via Inverter Configuration Software are also available.

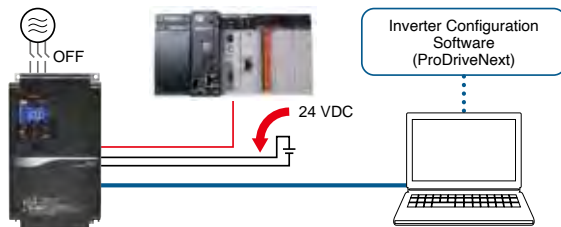

Verify an operation without motor output

version UP

The simulation mode makes it easier to verify connection with the system control equipment.

In the simulation mode, only the motor output is shut off while all inverter functions are enabled. Full simulation allows to generate an alarm by setting the virtual output conditions, such as current etc. utilizing parameter and the analog inputs. Hence, it is possible to confirm the operation of the control equipment without a motor. The simulation mode can also be active by using an external 24 VDC power supply.

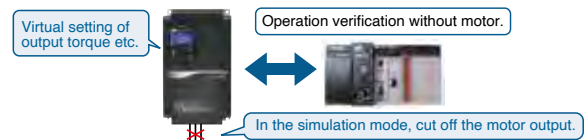

Refer to the Parameter **PA-20 to PA-31**

Quick diagnosis during failure

version UP

The SJ series P1 automatically stores internal data in retentive memory*.

Users can upload the data to a PC for review and diagnosis of issue.



(*This memory data is cleared at power shutdown.)

Easy customization by Inverter Configuration Software

EzSQ

ProDriveNext

P.15-16

By this Inverter Configuration Software, parameter setting, monitor and diagnosis can be easily achieved.

Easy customization to your own inverter.

P.17-18

Specific behavior can be easily programmed into the inverter by BASIC like program.

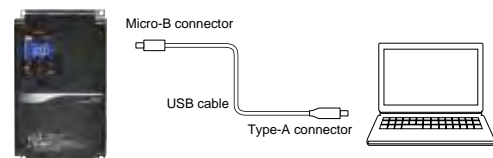

2 Driving Performance

A High Performance drive for the most demanding applications



"Smooth operation" in high demanding applications such as vertical lift

High starting torque at low speed range while in control of heavy loads (ND rating).
 [Sensor less vector control(SLV)]
 [OHZ sensor less vector control]

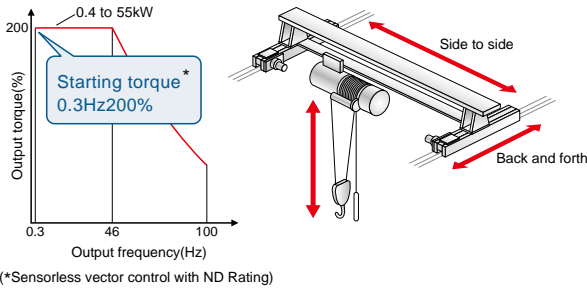

Decreasing overshoot and undershoot contributes to smooth and stabilized operation with reduced load shock.
 [Gain mapping Function]

⓪ Disable function

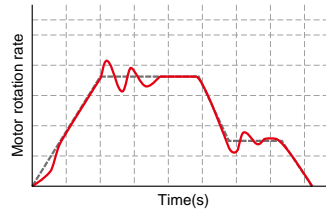

Reduction of swinging load, leading to better operational control and productivity.

⓪ Enable function

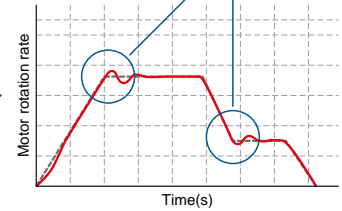

Trip-less motor operation for crane, lift, transport, etc.

To assist you in better productivity.



Refer to the Parameter **AA121/HA-01 to /Hb102 to**



Reduce costs for spare controllers

Our multi-mode inverter can control both induction motors and permanent magnet AC motors.
 Over current detection parameter can be set lower to protect from demagnetizing PM motor.

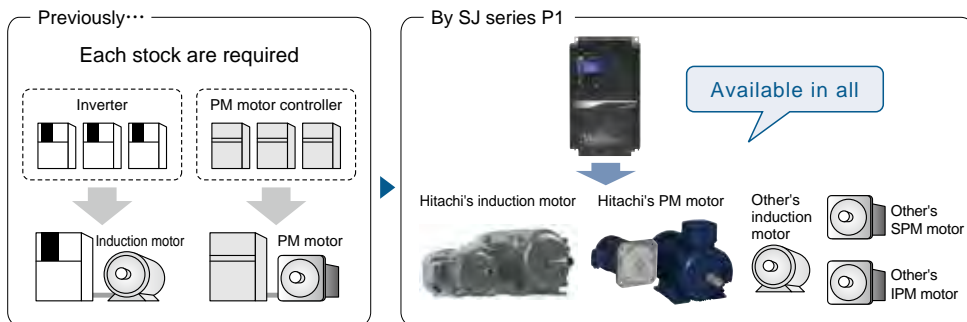

Optimize performance.
 [Auto-tuning function]

Complicated tuning procedures are avoided through the use of our auto-tuning function to optimize motor performance.

For long-time operation(fans, pumps)

Significant energy savings can be obtained by PM motor, especially in 24 hours 365 days operation.



Refer to the Parameter **AA121/bb160/HA-01 to /Hd102 to**



Improvement or added item.



EzSQ application case. refer to P17-18 for details.



PM motor specific function.

"High speed rotation" for non-traditional applications



590Hz at the maximum operation is available for precise metal processing. For PM motor, also up to 590Hz. (actual output frequency depends on motor)

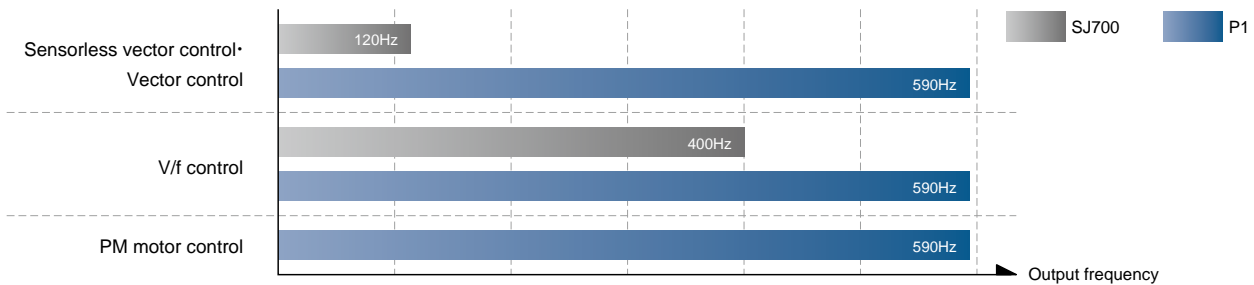

For metal tooling

High speed rotation contributes the high quality of metal processing.



Refer to the Parameter **Hb105/Hd105**

Reduce trips on acceleration and deceleration



Automatic speed adjustment manages ideal acceleration / deceleration speed to reduce the trip possibility from over current, over voltage, and impact load.

Over magnetization function

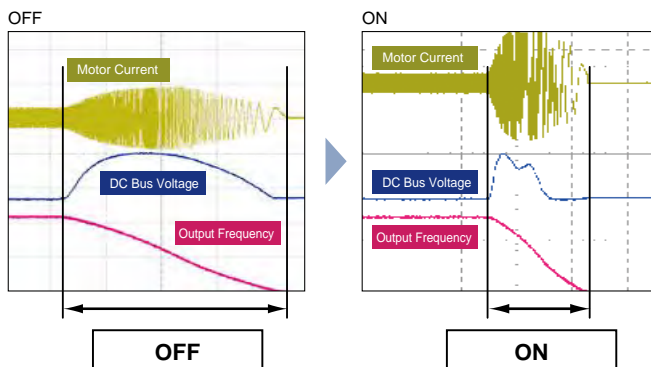

Over current suppress function

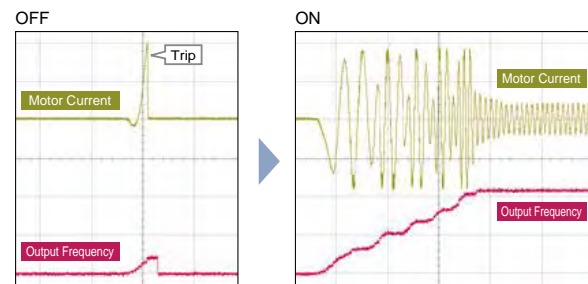

*Turn off this function for lifting equipment.

Refer to the Parameter **ba140 to /ba120 to**

*Image of the output frequency and output current.

Flexibility

Versatility through multi mode operation, to meet your specific application needs.

SJ series P1 meets a wide range of needs by a variety of functions

version
UP

Certified "functional safety" international standard

Certified functional safety. (Certification in process)

Third party certified electrical safety,
In compliance to IEC61508, IEC/EN61800-5-2 SIL3 STO,
available as standard.

- EN ISO/ISO 13849-1 PL e, CAT.4
- IEC 61508, EN/IEC 61800-5-2, EN/IEC 62061 SIL 3, STO

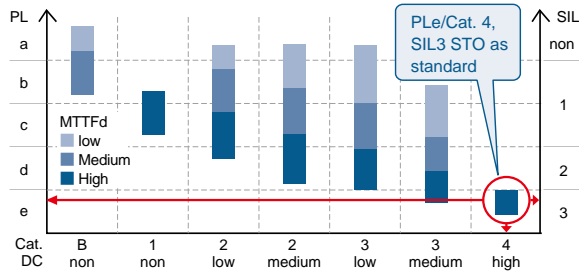

Standard (without option cassette)

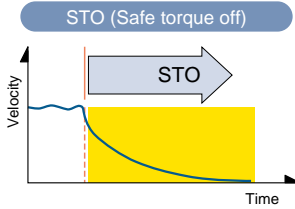

SS1, SLS and others are available with slot-in option cassette, P1-FS

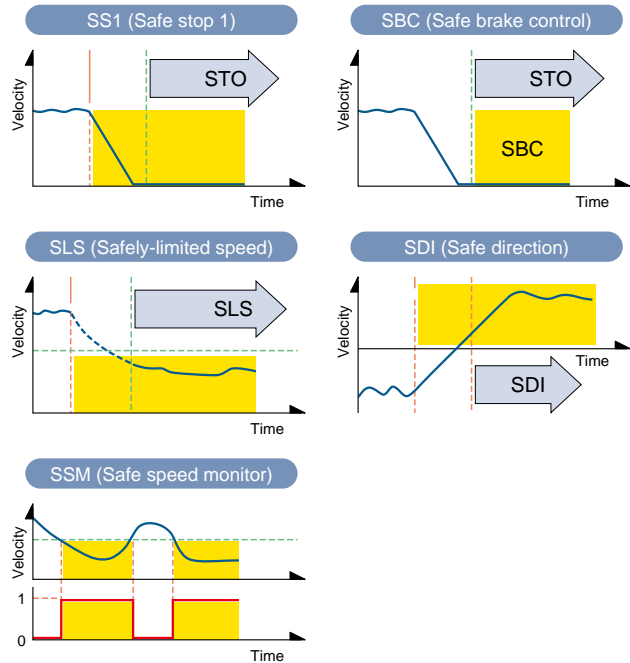

Optional (needs slot-in option cassette, P1-FS)



"Save space and save cost" by multiple rating function!

version
UP
PM
motor

SJ series P1 is multi-rated device for both induction motor and PM motor control.
The ratings are selectable according to your applications. Multiple rating function helps you save space and costs.

Rating	VLD(Very Light Duty)	LD(Light Duty)	ND(Normal Duty)
Induction motor	←→		
PM motor	←→*		
Applications	Fan·Pump	Metal tooling·Conveyer	
			Crane·Mixer
Overload current rating	110% 60sec, 120% 3sec	120% 60sec, 150% 3sec	150% 60sec, 200% 3sec
Example 200V/30.0kW Max rated output current	153A 	140A 	122A 

*IVMS start type sensorless vector control does not support VLD rating type

for drive systems.

- version UP** Improvement or added item.
- EzSQ** EzSQ application case, refer to P17-18 for details.
- PM motor** PM motor specific function.

Easy customization with "Slot-in" option cassette

version UP

Cassette type option boards for intuitive installation.

- Visible indicators on the option cassettes allow users to verify the status with ease.
- Simple station number setting with the rotary switch.
- Replacement is also simplified by the cassette design.

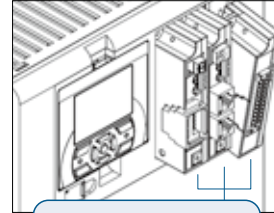

3 option slots

Options List.
Ethernet
EtherCAT
PROFIBUS-DP
PROFINET
Feedback
Safety
Analog input and output
DeviceNet
CC-Link

Network options are available for system expansion.

• Option communication and standard Modbus-RTU can be used together.

• Following fieldbus networks are available with option cassette.

(PROFIBUS-DP, PROFINET, EtherCAT, Ethernet, DeviceNet, CC-Link)

(Modbus® is a trademark and the property of Schneider Electric SE, its subsidiaries and affiliated companies. EtherCAT® is registered trademark and patented technology, licensed by Beckhoff Automation GmbH, Germany. PROFIBUS® and PROFINET® is registered trademark of PROFIBUS Nutzerorganisation e.V. (PNO). CC-Link® is trade names of Mitsubishi Electric Co. DeviceNet® is the trademark of Open DeviceNet Vendor Association, Inc. Other company names and product names mentioned are the property of the respective trademarks or registered trademarks.)



"High quality" to comply international standards

Corresponds to the EU Directive, UL and cUL in order to guarantee the quality and safety.

The quality is recognized in Europe.



EU Directive	LVD : IEC61800-5-1
	EMC directive : IEC61800-3
	RoHS2 directive: EN 50581:2012/EN IEC 63000:2018
UL	Power Conversion Equipment/UL61800-5-1

Built-in noise filters correspond to the European EMC Directive. (IEC61800-3 2nd Environment Category C3)

Complying with the RoHS2, SJ series P1 is environmentally considered.

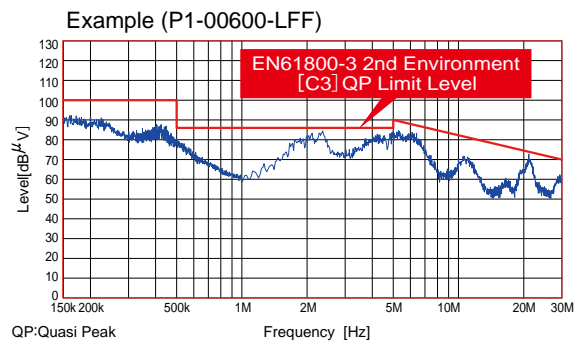

Braking circuit is built in. Further "Space and Cost saving"

version UP

The regenerative braking circuit is built in, therefore a separate regenerative braking unit (BRD) is not necessary. Saving space and cost.

- Applicable models
- 200V class 0.4 to 22kW
 - 400V class 0.75 to 55kW
- (400V class 45kW and 55kW is the order)

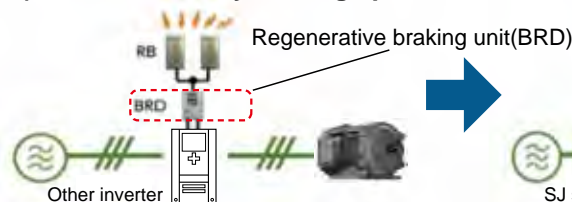

Regenerative braking unit (BRD) Unnecessary

SJ series P1 is applicable in a wide variety of applications.

Fan & Pump



[Energy saving by the inverter]

● Optimize for energy savings in pumping applications.

By utilizing a SJ series P1 inverter to control flow rates, significant energy saving can be obtained compared to the valve control.

□ Examples of energy-saving effect

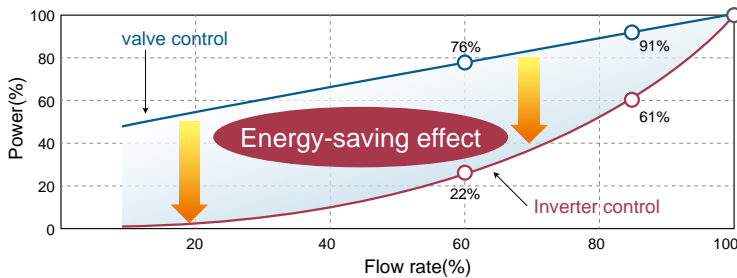

[Further energy saving by PM motor]

● Corresponds to both Induction motor and PM motor.

By using a PM motor, further energy savings can be realized.
(Please refer to the motor efficiency graph on the right)

● Simple adjustment to obtain high performance from your PM motor.

A PM motor can be optimized for the best performance by PM motor auto-tuning function.

□ Efficiency comparison of the induction motor and the PM motor

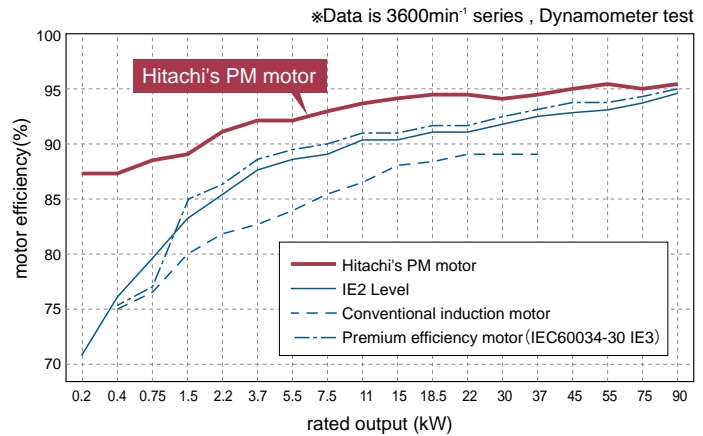

□ Hitachi induction motor and PM motor

■ Induction motor



Premium efficiency motor (IE3)

■ Permanent magnet motor

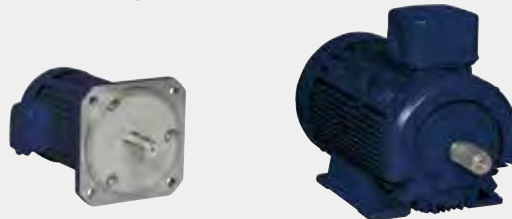

Recommended functions

- PM motor drive
- Multiple rating
- Modbus communication
- PID control
- PID Sleep mode
- PID Soft-start function
- Automatic energy-saving function

Refer to the next page

such as fan, pump and compressor.

EzSQ EzSQ application case, refer to P17-18 for details.
PM motor PM motor specific function.

New application features!
Fan & Pump

Optimal PID functions for Fan & Pump applications

SJ series P1 reduces the output to prevent water hammer effect from damaging your system when the PID starts.

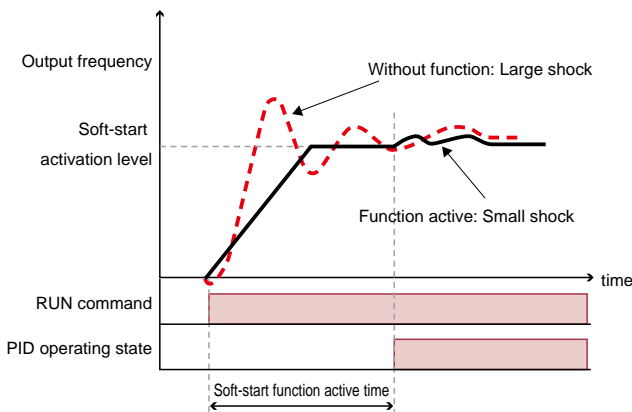

Refer to the Parameter **AH-75 to**

SJ series P1 automatically stops operating to save energy when not necessary.

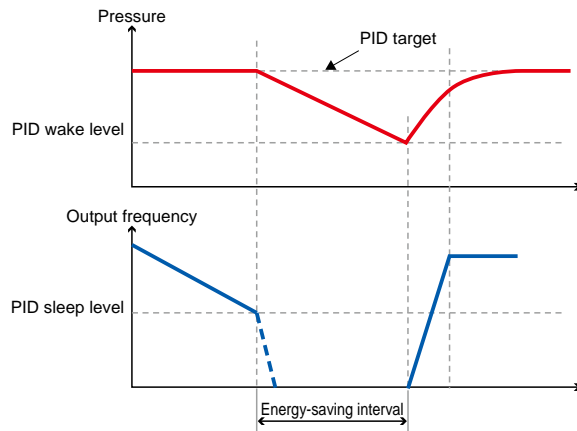

Refer to the Parameter **AH-85 to**

Hydraulic pump

EzSQ

Energy-saving achieved by EzSQ (programming function).

By using the EzSQ the rotation speed can be increased when more pressures are needed and decreased during stand by, which leads to energy optimization. Additionally and depending on the application the pressure sensor and/or relay circuits become unnecessary which allows costs and space reduction.

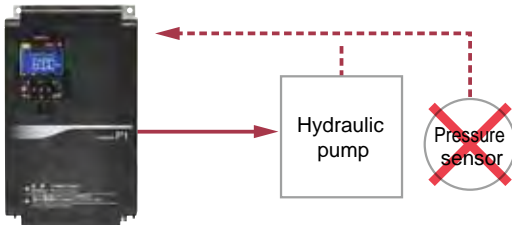

Example of the results of the hydraulic pump energy-saving test

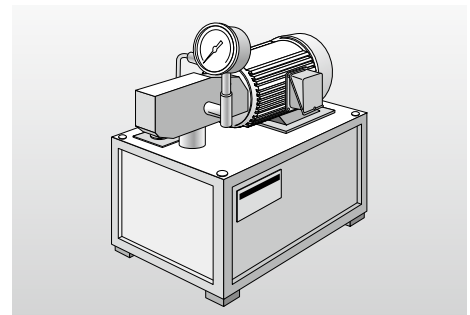
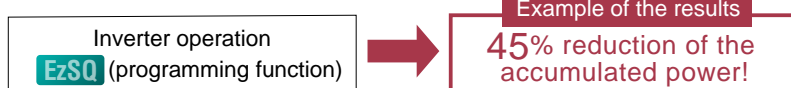

Recommended functions

- Multiple rating
- PID control
- PM motor drive
- Sensorless vector control
- EzSQ(programming function)

Hitachi inverters are used in a wide variety of industries because

Crane, Lift, Automatic warehouse

EzSQ

- Provides smooth drive control even for heavy weights.

Provides stable drive control even for the heavy weights (such as winching up and down cranes) by high start-up torque(0.3Hz, 200%).

*Note Hitachi Induction motor 4P (ND rating/Sensor-less vector control)

- Reduces the shock such as swinging load by gain switching.

Gain mapping function provides a vibration reduction and stable operation. It will be also effective in the tact time reduction.

- Space-saving and cost-down by the EzSQ(programming function).

By using EzSQ, it is possible to reduce components by eliminating the host controller for the drive, thus saving-space and cost.

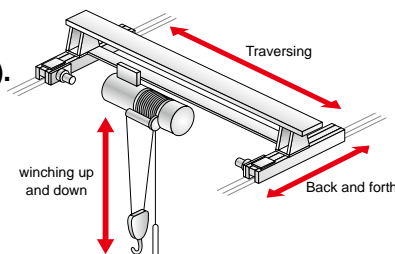

Recommended functions

- Sensorless vector control
- Gain mapping function
- EzSQ(programming function)

Injection molding machine

- Usable to injection molding machine requiring precise torque control

"Overload warning signal" and "Over torque signal" can apply to control the timing of the screw and the mold clamping.

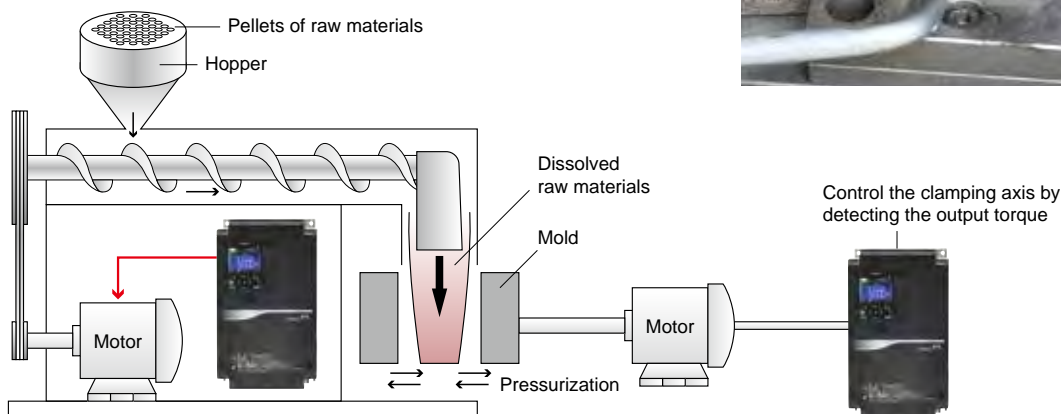

Recommended functions

- Torque control
- Torque limit function
- Overload signal
- Over torque signal
- Overload restriction function

of its high efficiency and high quality.

Winder

● Utilizing Gain Control.

More stable operation is possible by changing the speed response gain according to the operation status.

This is suitable for winder and re-winder applications.

● Usable to winding applications requiring highly precise rotation.

For closed-Loop application optional feedback board is required.



Recommended functions

- Vector control (feedback option board required)
- Gain mapping function ● Torque control

Grinder

EzSQ

PM motor

● Miniaturization by utilizing a PM motor.

● Further support to high-quality machining applications.

Maximum output frequency is 590 Hz. (Both induction motor and PM motor)

● EzSQ easily expands the possibility for a wide variety of applications.

By using the EzSQ programming function, the inverter is capable of changing the motor operation according to the required application, without the need of master or peripheral devices. This function helps you save costs and space.

E.g. As required by the application, the EzSQ can control many of the operation parameters such as the output frequency, overload level, overload signals and others.



Recommended functions

- PM motor drive ● EzSQ(programming function)

Inverter Configuration Software

Hitachi's ProDriveNext Software

Easy configuration, such as start/stop and fault diagnosis.

ProDriveNext (Inverter Configuration Software)

ProDriveNext supports various functions.

Easy Setup & Easy data management.
Parameter comparison is also enhanced.



Easy connection via USB

Ethernet is also available (optional)

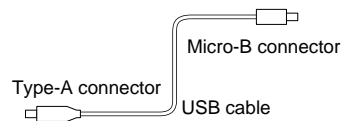

Monitor Function.

All parameters can be monitored and all setting parameters can be set.



Monitor display format can be uniquely customized by selecting the required items, and can be displayed in a tabular or graphical format.

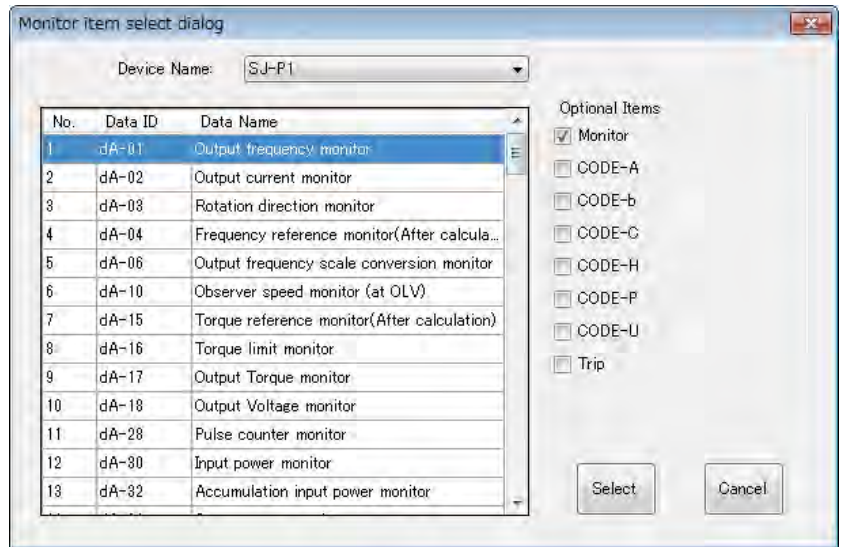

Cycle: 258 msec

Device Name	Data ID	Data Name	Process value	Unit
SJ-P1	dA-01	Output frequency monitor	10	Hz
SJ-P1	dA-02	Output current monitor	1.08	A
SJ-P1	dA-03	Rotation direction monitor	F(Forward RUN)	
SJ-P1	dA-04	Frequency reference monitor(After calcula...	10	Hz
SJ-P1	dA-06	Output frequency scale conversion moni...	10	
SJ-P1	dA-17	Output Torque monitor	0	N
SJ-P1	dA-18	Output Voltage monitor	40	V
SJ-P1	dA-30	Input power monitor	0	kW
SJ-P1	dA-34	Output power monitor	0.02	kW
SJ-P1	dA-43	DC-bus voltage monitor	279.9	Vdc
SJ-P1	dA-42	Electronic thermal Load rating monitor (...)	0	N
SJ-P1	FA-01	Main Speed reference monitor	10	Hz
SJ-P1	FA-15	Torque reference monitor	0	N
SJ-P1	FA-16	Torque limit monitor	0	N

[Table type monitor]



[Graph type monitor]

Parameter Setting.

It achieves smoother parameter setting.

Changed parameters are highlighted in "PINK", which indicates it needs to be download to the device.

Data ID	Data Name	Setting value	Current value	Unit	Default value	Range
AA101	Main speed input source select.	07(Setting by para.)	07(Setting by para.)		07(Setting by para.)	
AA102	Sub frequency input source sele.	00(Disable)	00(Disable)		00(Disable)	
AA104	Sub speed setting, 1st-motor	0.00	0.00	Hz	0.00	0.00 ~ 500.00
AA105	Calculation symbol selection for	00(Disable)	00(Disable)		00(Disable)	
AA106	Add frequency setting, 1st-motor	0.00	0.00	Hz	0.00	-500.00 ~ 500.00
AA111	Run-command input source select.	02(RUN key on key)	02(RUN key on key)		02(RUN key on key)	
AA112	RUN-key Direction of keypad. 1.	00(Forward)	00(Forward)		00(Forward)	
AA113	STOP-key enable at RUN-comm.	01(Enable)	01(Enable)		01(Enable)	
AA114	RUN-direction restriction, 1st-m.	00(Disable)	00(Disable)		00(Disable)	
AA115	STOP mode selection, 1st-motor	00(Deceleration unit)	00(Deceleration unit)		00(Deceleration unit)	
AA201	Main speed input source select.	07(Setting by para.)	07(Setting by para.)		07(Setting by para.)	
AA202	Sub speed input source selectio.	00(Disable)	00(Disable)		00(Disable)	
AA204	Sub speed setting, 2nd-motor	0.00	0.00	Hz	0.00	0.00 ~ 500.00
AA205	Calculation symbol selection for	00(Disable)	00(Disable)		00(Disable)	
AA206	Add frequency setting, 2nd-motor	0.00	0.00	Hz	0.00	-500.00 ~ 500.00
AA211	Run-command input source sele.	02(RUN key on key)	02(RUN key on key)		02(RUN key on key)	
AA314	DC braking selection, 1st-motor	00(Disable)	00(Disable)		00(Disable)	

[Parameter setting display]

Extensive parameter comparison function.

Parameter management is supported by comparison functions below.

- [Setting value] - [Current value],
- [Setting value] - [Default value]
- [Setting value] - [File value]

Parameter	Setting value	Default value
Pr-01	10.00	1.00
Fx-01	20.00	20.00
AA111	00(Sensorless (PNC/PRD))	02(RUN key on keypad)
AA120	00(Sensorless vector clark)	00(VF clark) (Default for)
AP-01	02(Setting by Terminal (AND))	01(Setting by parameter)
AP-03	02(Setting by Terminal (AND))	00(Disable)
PA-03	01(Enable)	00(Disable)
PA-04	01(Enable during constant)	01(Enable during accel. and

Data Trace function supports failure diagnoses.

The data will be stored in the internal memory in real time by specified trigger such as frequency reach, alarm or other signals*. Operation adjustment and failure analysis becomes more quickly.

(*This memory data is cleared at power shutdown.)

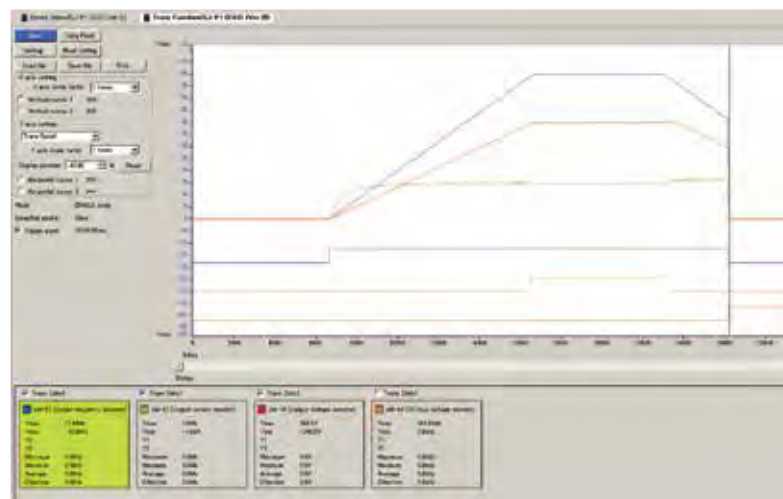

Inverter Configuration Software

Easily Customizable

Hitachi's programming function(EzSQ) and inverter-to-inverter communication (EzCOM) allows you to customize uniquely your

EzSQ

EzSQ (programming function for customization)

Line	Label	Mnemonic	Parameter1	Parameter2	Parameter3	Parameter4	Parameter5	F
7		case	1					
8		call	RUN_FW					
9		case	2					
10		call	RUN_RV					
11		case	3					
12		call	WAIT_RUN					
13		case else						
14		call	STOP					
15		end select						
16		goto	LOOP					
17								
18		sub	STOP					
19		UBW=	XW	and	3			
20		if	UBW	<	2	then	LBLO	
21		FW=	1					
22		timer set	TD(0)	U(00)				
23		U(31)=			1			
24	LBLO	end sub						
25								

EzSQ enables the better suited control for your applications, providing unique solution and additional value such as cost savings and improved performance that cannot be achieved by a general purpose inverter. Simultaneous execution task in SJ series P1 is extended to 5 tasks / 1 ms. (SJ700 is 1 task / 2 ms.)

The program is created on a Inverter Configuration Software (ProDriveNext). It is easy to program because it's similar to BASIC!

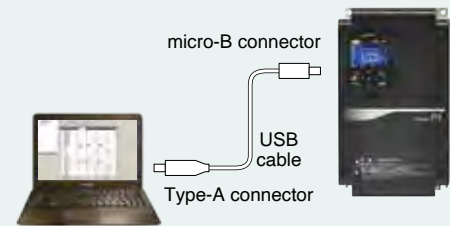

The program is easy to create with available condition branches and timer settings.

EzCOM

Inverter-to-Inverter communication

SJ series P1 enables Inverter-to-Inverter communication without a PLC or PC. [EzCOM function]

EzCOM makes it easier to build a small synchronous system between multiple SJ series P1 inverters.

By using EzCOM and external communication options together, you can create complicated control systems with simple wiring.

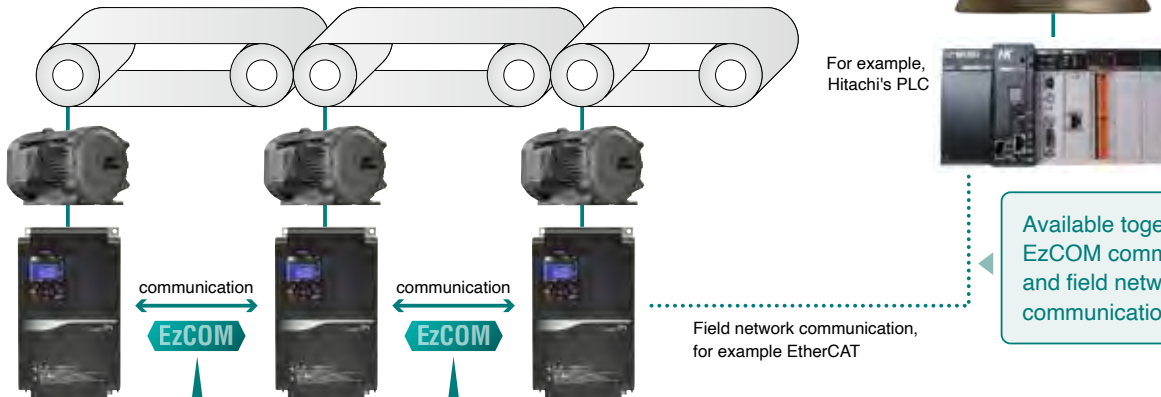

Available together, EzCOM communication and field network communication options.

By simple wiring and easy parameter settings, the synchronous operation can be achieved without the host controller (Helping save costs and wiring).

inverter for each applications beyond available fixed parameter.

EzSQ

Your own "Add-on-value" by EzSQ(programming function)

EzCOM

version UP

Application case 1

Reduction of the external circuit components.

In a system that would normally require external circuit components such as a relay, timer and switch, it is possible to reduce the use of those external components by using the EzSQ (programming function).

For example, the Forward, Reverse and Stop systems shown in below are parts of the external relay circuit, which are no longer required when using EzSQ function.

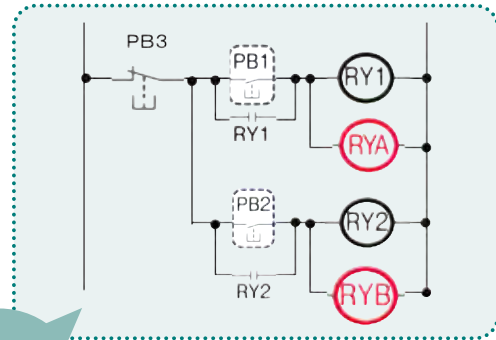
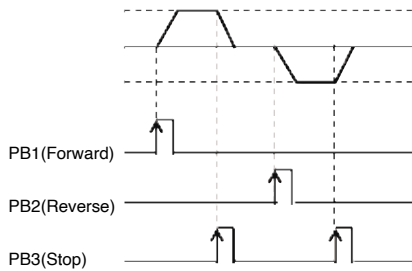

Not Required !

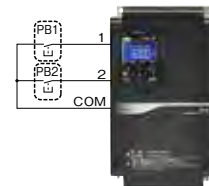

Application case 2

Advanced operation pattern is reproduced without sensors.

Mixing Machine:

At first mixing the material slowly and then increasing the mixing speed (by monitoring the load current). This speed change can be done automatically when using EzSQ.

Advanced speed patterns can be easily created for each application.

Application case 3

Multiple control is easy.

Winder:

EzCOM is a simple communication function that can be used for winders that would previously required multiple controllers. Construction of multiple systems can be simply achieved by reducing wiring works. Maintenance is also easy.

Application case 4

Check for water leakage without sensors.

Pump control:

Attaching a sensor to various places of the drainage pipe is costly.

EzSQ program that outputs an alarm to calculate the water leakage from the operating status of the pump can be utilized in place of a sensor.

©For example of Water leakage detections from pipe.

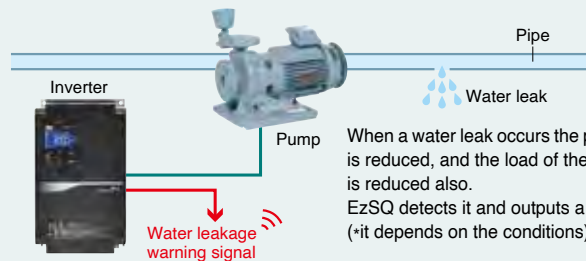

When a water leak occurs the pressure is reduced, and the load of the inverter is reduced also. EzSQ detects it and outputs a warning (+it depends on the conditions).

Further examples of EzSQ use

- For reducing maintenance cost...
 - Water leakage detections from pipe, Dust blowouts for fans.
- For additional protective features...
 - Avoiding water hammers, Multi speed adjustment during mixing process.

- For further energy savings...
 - Ideal output controls for fan & pumps, Sleep modes for conveyers non-regular used.
- For stand-alone works on multi uses...
 - Automatic operations of the fan and pumps based on user customization PID.

Contact Hitachi for more information!

EzSQ function can enable following.

With the combination of these, customized functions can be easily implemented.

- Collect information of inverter's internal data such as load current, frequency, and etc.
- Input and output IO (including analogue IOs) can be freely assigned to your own function.
- Arithmetic operations (internal calculation), Rewriting inverter parameters, Sequential programming(such as conditions branches), Internal timers, and more other functions...

Model configuration

• SJ series P1 model name indication

P1 - 00175 - H F F

Type Name

Motor maximum rated current
(at VLD rated current)

00001: 0.1A

to

99999: 9999.9A

F: Integrated EMC filter

Region

E: Europe version

U: North America version

C: China version

None: Japan version

F: with Operator

Power Source

L: 3-phase 200V class

H: 3-phase 400V class

• Lineup

Applicable motor (kW)	0.4	0.75	1.5	2.2	3.7	5.5	7.5	11	15	18.5	22	30	37	45	55	75	90	110	132	160	185	200	220	250	315	
3-phase 200 V (ND rating)	●	●	●	●	●	●	●	●	●	●	●	●	●	●	●											
3-phase 400 V (ND rating)		●	●	●	●	●	●	●	●	●	●	●	●	●	●	●	●	●	●	●	●	●	●	●	●	●

(Note) The applicable motor refers to Hitachi standard 3-phase motor (4-pole).
To use other motors, be sure to prevent the rated motor current from exceeding the rated output current of the inverter.

Applicable motor capacity by rating

• Overload current rating

VLD (Very light duty): 110% 60sec, 120% 3sec

LD (Light duty): 120% 60sec, 150% 3sec

ND (Normal duty): 150% 60sec, 200% 3sec



• 200V class

ND Rating Code*	Model name	VLD (Very light duty)		LD (Light duty)		ND (Normal duty)	
		Motor capacity (kW(HP)) (4pole)	Rated current (A)	Motor capacity (kW(HP)) (4pole)	Rated current (A)	Motor capacity (kW(HP)) (4pole)	Rated current (A)
004	00044	0.75 (1)	4.4	0.75 (1)	3.7	0.4 (1/2)	3.2
007	00080	1.5 (2)	8.0	1.5 (2)	6.3	0.75 (1)	5.0
015	00104	2.2 (3)	10.4	2.2 (3)	9.4	1.5 (2)	8.0
022	00156	3.7 (5)	15.6	3.7 (5)	12.0	2.2 (3)	11.0
037	00228	5.5 (7.5)	22.8	5.5 (7.5)	19.6	3.7 (5)	17.5
055	00330	7.5 (10)	33.0	7.5 (10)	30.0	5.5 (7.5)	25.0
075	00460	11 (15)	46.0	11 (15)	40.0	7.5 (10)	32.0
110	00600	15 (20)	60.0	15 (20)	56.0	11 (15)	46.0
150	00800	18.5 (25)	80.0	18.5 (25)	73.0	15 (20)	64.0
185	00930	22 (30)	93.0	22 (30)	85.0	18.5 (25)	76.0
220	01240	30 (40)	124	30 (40)	113	22 (30)	95.0
300	01530	37 (50)	153	37 (50)	140	30 (40)	122
370	01850	45 (60)	185	45 (60)	169	37 (50)	146
450	02290	55 (75)	229	55 (75)	210	45 (60)	182
550	02950	75 (100)	295	75 (100)	270	55 (75)	220

*The inverter ND rating code corresponds to the motor capacity that it can handle in ND mode. (004 corresponds to 0.4kW)

• 400V class

ND Rating Code	Model name	VLD (Very light duty)		LD (Light duty)		ND (Normal duty)	
		Motor capacity (kW(HP)) (4pole)	Rated current (A)	Motor capacity (kW(HP)) (4pole)	Rated current (A)	Motor capacity (kW(HP)) (4pole)	Rated current (A)
007	00041	1.5 (2)	4.1	1.5 (2)	3.1	0.75 (1)	2.5
015	00054	2.2 (3)	5.4	2.2 (3)	4.8	1.5 (2)	4.0
022	00083	3.7 (5)	8.3	3.7 (5)	6.7	2.2 (3)	5.5
037	00126	5.5 (7.5)	12.6	5.5 (7.5)	11.1	3.7 (5)	9.2
055	00175	7.5 (10)	17.5	7.5 (10)	16.0	5.5 (7.5)	14.8
075	00250	11 (15)	25.0	11 (15)	22.0	7.5 (10)	19.0
110	00310	15 (20)	31.0	15 (20)	29.0	11 (15)	25.0
150	00400	18.5 (25)	40.0	18.5 (25)	37.0	15 (20)	32.0
185	00470	22 (30)	47.0	22 (30)	43.0	18.5 (25)	39.0
220	00620	30 (40)	62.0	30 (40)	57.0	22 (30)	48.0
300	00770	37 (50)	77.0	37 (50)	70.0	30 (40)	61.0
370	00930	45 (60)	93.0	45 (60)	85.0	37 (50)	75.0
450	01160	55 (75)	116	55 (75)	105	45 (60)	91.0
550	01470	75 (100)	147	75 (100)	135	55 (75)	112
750	01760	90 (125)	176	90 (125)	160	75 (100)	150
900	02130	110 (150)	213	110 (150)	195	90 (125)	180
1100	02520	132 (175)	252	132 (175)	230	110 (150)	217
1320	03160	160 (220)	316	160 (220)	290	132 (175)	260
1600	03720	185 (250)	372	185 (250)	341	160 (220)	310
1850	04320	200 (270)	432	200 (270)	395	185 (250)	370
2000	04860	220 (300)	486	220 (300)	446	200 (270)	405
2200	05200	250 (335)	520	250 (335)	481	220 (300)	450
2500	05500	-	-	280 (380)	550	250 (335)	500
3150	06600	-	-	355 (450)	660	315 (400)	600

Standard Specifications

• 200V class specifications

Model name (P1-□□□□□-L)		00044	00080	00104	00156	00228	00330	00460	00600	00800	00930	01240	01530	01850	02290	02950		
Applicable motor capacity (4 poles) (kW) (*1)	VLD	0.75	1.5	2.2	3.7	5.5	7.5	11	15	18.5	22	30	37	45	55	75		
	LD	0.75	1.5	2.2	3.7	5.5	7.5	11	15	18.5	22	30	37	45	55	75		
	ND	0.4	0.75	1.5	2.2	3.7	5.5	7.5	11	15	18.5	22	30	37	45	55		
Rated output current (A)(*2)	VLD	4.4	8.0	10.4	15.6	22.8	33.0	46.0	60.0	80.0	93.0	124	153	185	229	295		
	LD	3.7	6.3	9.4	12.0	19.6	30.0	40.0	56.0	73.0	85.0	113	140	169	210	270		
	ND	3.2	5.0	8.0	11.0	17.5	25.0	32.0	46.0	64.0	76.0	95.0	122	146	182	220		
Overload current rating	VLD	110% 60sec / 120% 3sec																
	LD	120% 60sec / 150% 3sec																
	ND	150% 60sec / 200% 3sec																
Rated output voltage		Three-phase (3 wire) 200 to 240V (Corresponding to the incoming voltage)																
Rated capacity (kVA) (*4)	200V	VLD	1.5	2.7	3.6	5.4	7.8	11.4	15.9	20.7	27.7	32.2	42.9	53.0	64.0	79.3	102	
		LD	1.2	2.1	3.2	4.1	6.7	10.3	13.8	19.3	25.2	29.4	39.1	48.4	58.5	72.7	93.5	
		ND	1.1	1.7	2.7	3.8	6.0	8.6	11.0	15.9	22.1	26.3	32.9	42.2	50.5	63.0	76.2	
	240V	VLD	1.8	3.3	4.3	6.4	9.4	13.7	19.1	24.9	33.2	38.6	51.5	63.6	76.9	95.1	123	
		LD	1.5	2.6	3.9	4.9	8.1	12.4	16.6	23.2	30.3	35.3	46.9	58.1	70.2	87.2	112	
		ND	1.3	2.0	3.3	4.5	7.2	10.3	13.3	19.1	26.6	31.5	39.4	50.7	60.6	75.6	91.4	
Input	Rated input AC voltage (*3)		Main circuit power supply: Three-phase (3 wire) 200 to 240V 50Hz/60Hz Control power supply : Single-phase supply 200 to 240V 50Hz/60Hz															
	Permissible AC voltage/ Frequency fluctuation (*3)		AC voltage : 170 to 264V 50/60Hz, Frequency :±5%															
	Power supply capacity (kVA) (*4)		VLD	2.0	3.7	4.8	7.1	10.4	15.0	20.9	27.3	36.3	42.2	56.3	69.4	84.0	104	134
Carrier frequency variation (*5)	VLD		0.5 to 10.0kHz															
	LD		0.5 to 12.0kHz															
	ND		0.5 to 16.0kHz															
Starting torque (*6)		200% / 0.3Hz																
Braking	Regenerative Braking		Internal BRD circuit (external discharge resistor value)												External regenerative braking unit			
	Minimum resistance value (Ω)		50	50	35	35	35	16	10	10	7.5	7.5	5	-	-	-	-	
Protective structure		IP20 – UL Open Type																
Aprox. weight (kg)		3	3	3	3	3	6	6	6	10	10	10	22	33	33	47		

*1: The applicable motor refers to Hitachi standard 3-phase motor (4-pole). To use other motors, be sure to prevent the rated motor current (50Hz) from exceeding the rated output current of the inverter.

*2: Some models require current derating depending on the carrier frequency setting and ambient temperature.

*3: In order to comply with the Low Voltage Directive (VLD), it must be connected to a neutral grounding supply.

-Pollution degree 2 - Overvoltage category 3

*4: The power supply capacity is the value of the rated output current at 220V. The value of the impedance at the supply side changes due to the wiring, breaker, input reactor, etc.

*5: The carrier frequency may be limited depending on how the inverter is being used.

*6: The value is specified for the Hitachi standard motor controlled by the sensorless vector control when ND rating.

Torque characteristics may vary by the control system and the use of the motor.

Standard Specifications

● 400V class specifications

Model name (P1-□□□□□-H)		00041	00054	00083	00126	00175	00250	00310	00400	00470	00620	00770	00930	01160	01470													
Applicable motor capacity (4 poles) (kW) (*1)	VLD	1.5	2.2	3.7	5.5	7.5	11	15	18.5	22	30	37	45	55	75													
	LD	1.5	2.2	3.7	5.5	7.5	11	15	18.5	22	30	37	45	55	75													
	ND	0.75	1.5	2.2	3.7	5.5	7.5	11	15	18.5	22	30	37	45	55													
Rated output current (A)(*2)	VLD	4.1	5.4	8.3	12.6	17.5	25.0	31.0	40.0	47.0	62.0	77.0	93.0	116	147													
	LD	3.1	4.8	6.7	11.1	16.0	22.0	29.0	37.0	43.0	57.0	70.0	85.0	105	135													
	ND	2.5	4.0	5.5	9.2	14.8	19.0	25.0	32.0	39.0	48.0	61.0	75.0	91.0	112													
Overload current rating	VLD	110% 60sec / 120% 3sec																										
	LD	120% 60sec / 150% 3sec																										
	ND	150% 60sec / 200% 3sec																										
Output	Rated output voltage	Three-phase (3 wire) 380 to 500V (Corresponding to the incoming voltage)																										
Rated capacity (kVA)	400V	VLD	2.8	3.7	5.7	8.7	12.1	17.3	21.4	27.7	32.5	42.9	53.3	64.4	80.3	102												
		LD	2.1	3.3	4.6	7.6	11.0	15.2	20.0	25.6	29.7	39.4	48.4	58.8	72.7	93.5												
		ND	1.7	2.7	3.8	6.3	10.2	13.1	17.3	22.1	27.0	33.2	42.2	51.9	63.0	77.5												
	500V	VLD	3.5	4.6	7.1	10.9	15.1	21.6	26.8	34.6	40.7	53.6	66.6	80.5	100	127												
		LD	2.6	4.1	5.8	9.6	13.8	19.0	25.1	32.0	37.2	49.3	60.6	73.6	90.9	117												
		ND	2.1	3.4	4.7	7.9	12.8	16.4	21.6	27.7	33.7	41.5	52.8	64.9	78.8	96.9												
Input	Rated input AC voltage (*3)	Main circuit power supply: Three-phase(3 wire) 380 to 500V 50Hz/60Hz Control power supply: Single-phase supply 380 to 500V 50Hz/60Hz																										
	Permissible AC voltage/ Frequency fluctuation (*3)	AC voltage:323 to 550V 50/60Hz, Frequency :±5%																										
	Power supply capacity (kVA) (*4)	VLD	3.8	4.9	7.6	11.5	15.9	22.8	28.2	36.3	42.7	56.3	69.9	84.4	105	133												
Carrier frequency range (*5)	LD	2.9	4.4	6.1	10.1	14.5	20.0	26.3	33.6	39.1	51.8	63.5	77.2	95.3	123													
	ND	2.3	3.7	5.0	8.4	13.5	17.3	22.8	29.1	35.4	43.6	55.4	68.1	82.6	102													
	VLD	0.5 to 10.0kHz																										
Starting torque (*6)	LD	0.5 to 12.0kHz																										
	ND	0.5 to 16.0kHz																										
	VLD	200% / 0.3Hz																										
Braking	Regenerative Braking	Internal BRD circuit (external discharge resistor value)													(*7)													
	Minimum resistance value (Ω)	100	100	100	70	70	35	35	24	24	20	15	15	10	10													
Protective structure	IP20 – UL Open Type																											
Aprox. weight (kg)	3		3		3		3		6		6		6		8.5		8.5		8.5		22		31		31		31	

Model name (P1-□□□□□-H)		01760	02130	02520	03160	03720	04320	04860	05200	05500	06600									
Applicable motor capacity (4 poles) (kW) (*1)	VLD	90	110	132	160	185	200	220	250	–	–									
	LD	90	110	132	160	185	200	220	250	280	355									
	ND	75	90	110	132	160	185	200	220	250	315									
Rated output current (A)(*2)	VLD	176	213	252	316	372	432	486	520	–	–									
	LD	160	195	230	290	341	395	446	481	550	660									
	ND	150	180	217	260	310	370	405	450	500	600									
Overload current rating	VLD	110% 60sec / 120% 3sec									–	–								
	LD	120% 60sec / 150% 3sec																		
	ND	150% 60sec / 200% 3sec																		
Output	Rated output voltage	Three-phase (3 wire) 380 to 500V (Corresponding to the incoming voltage)																		
Rated capacity (kVA)	400V	VLD	122	148	175	219	258	299	337	360	–	–								
		LD	111	135	159	201	236	274	309	333	381	457								
		ND	104	125	150	180	215	256	281	312	346	416								
	500V	VLD	152	184	218	274	322	374	421	450	–	–								
		LD	139	169	199	251	295	342	386	417	476	572								
		ND	130	156	188	225	268	320	351	390	433	520								
Input	Rated input AC voltage (*3)	Main circuit power supply: Three-phase(3 wire) 380 to 500V 50Hz/60Hz Control power supply: Single-phase supply 380 to 500V 50Hz/60Hz																		
	Permissible AC voltage/ Frequency fluctuation (*3)	AC voltage:323 to 550V 50/60Hz, Frequency :±5%																		
	Power supply capacity (kVA) (*4)	VLD	160	193	229	287	338	392	441	472	–	–								
Carrier frequency variation (*5)	LD	145	177	209	263	310	358	405	436	499	599									
	ND	136	163	197	236	281	336	368	408	454	544									
	VLD	0.5 to 8.0kHz																		
Starting torque (*6)	LD	0.5 to 8.0kHz																		
	ND	0.5 to 10.0kHz																		
	VLD	180% / 0.3Hz																		
Braking	Regenerative Braking	External regenerative braking unit																		
	Minimum resistance value (Ω)	–	–	–	–	–	–	–	–	–	–									
Protective structure	IP20 – UL Open Type																			
Aprox. weight (kg)	41		41		53		53		95		125		125		125		125		170	

- *1: The applicable motor refers to Hitachi standard 3-phase motor (4-pole). To use other motors, be sure to prevent the rated motor current (50Hz) from exceeding the rated output current of the inverter.
 *2: Some models require current derating depending on the carrier frequency setting and ambient temperature.
 *3: In order to comply with the Low Voltage Directive (VLD), it must be connected to a neutral grounding supply.
 -Pollution degree 2, - Overvoltage category 3 (for 380 to 460 VAC Input supply), - Overvoltage category 2 (for over 460 VAC Input supply)
 *4: The power supply capacity is the value of the rated output current at 440V. The value of the impedance at the supply side changes due to the wiring, breaker, input reactor, etc.
 *5: The carrier frequency may be limited depending on how the inverter is being used.
 *6: The value is specified for the Hitachi standard motor controlled by the sensorless vector control when ND rating. Torque characteristics may vary by the control system and the use of the motor.
 *7: Usually an external regenerative braking unit is required. However, with an optional built-in chopper braking circuit and external discharge resistor can eliminate an external regenerative unit. The built-in chopper braking circuit is offered by order. In order to purchase, contact to the nearest sales office.

Common specifications

Items		General Specifications		
PWM system		Sine-wave PWM system		
Output frequency range (*1)		0.00 to 590.00Hz		
Frequency accuracy		For the highest frequency, digital±0.01%, analog±0.2% (25±10°C)		
Frequency resolution		Digital: 0.01Hz, Analog: Ai1 terminal/Ai2 terminal:12bit/0 to +10V or 0 to +20mA, Ai3 terminal:12bit/-10 to +10V		
Control system (*2)		IM	V/f control (constant torque/reduced torque/ free / automatic boost control) V/f with encoder(constant torque/reduced torque/ free / automatic boost control) Cascade type sensorless vector control, 0Hz sensorless vector control, Vector control with encoder	
		SM/PMM	Synchronous startup for smart sensorless vector control, IVMS start type sensorless vector control	
Speed fluctuation (*3)		±0.5% (sensorless vector control)		
Acceleration/deceleration time		0.00 to 3600.00s (Linear, S-curve, U-curve, Inverted-U-curve, EL-S-curve)		
Display		Output frequency, Output current, Output torque, Trip history, Input/Output terminal status, Input/Output terminal function, Input/Output power (*4), PN voltage, etc.		
Start functions		DC braking after the start, matching frequency after the start, active frequency matching start, Low-voltage start, retry restart.		
Stop functions		After free run stop, deceleration stop, DC braking or external DC braking operation (Braking force, time, adjustment of operation speed)		
Stall prevention function		Overload limit function, overcurrent suppression, overvoltage suppression function		
Protection functions (*5)		Overcurrent error, Motor overload error, Braking resistor overload error, Overvoltage error, Memory error, Undervoltage error, Current detector error, CPU error, External trip error, USP error, Ground fault error, Power supply overvoltage error, Instantaneous power failure error, Temperature detector error, Cooling fan rotation speed reduction temperature error, Temperature error, Input open-phase error, IGBT error, Output open-phase error, Thermistor error, Brake error, Low-speed range overload error, Controller(inverter) overload error, RS485 communication error, RTC error, EzSQ related errors, Option related errors, Functional safety related errors, Encoder disconnection error, Position control range error, Speed deviation error, Position deviation error, Over-speed error, Contactor error, Feedback option connection error, PID start error.		
Other functions		V/f free setting (7 points), upper and lower speed limit, speed jump, curve acceleration and deceleration, manual torque boost, energy-saven operation, analog output adjustment, minimum speed, carrier frequency adjustment, motor electronic thermal function(free is possible), inverter thermal function, external start-end(speed and rate), frequency input selection, trip retry, restart stop, various signal output, inilization setting, PID control, auto-decel at shut-off, brake control function, commercial power switching function, auto-tuning (on/offline), etc.		
Input	Frequency reference	Keypad	The parameters for the command value (Set by operating the arrow keys on the keypad)	
		External signal (*6)	Ai1 / Ai2 terminal (Current and Voltage is able to switched.)	0 to 10 VDC (input impedance: 10kΩ) / 0 to 20mA (input impedance: 100Ω)
			Ai3 terminal	-10 to +10 VDC set by the voltage input (Input impedance:10kΩ)
			Multi-speed terminal	16multi-speed (With the use of the intelligent input terminal)
	Communication port	Pulse train-input	Maximum 32 kHz x2	
		RS485 serial communication (Protocol: Modbus-RTU)		
	RUN/ Stop Forward/ Reverse	Keypad	RUN/Stop key (With the set parameter, forward/reverse can be switched)	
		External signal	Forward (FW)/ Reverse(RV)/ 3-wire input (When input terminal functions are allocated)	
		Communication port	Set by RS485 communication (Maximum: 115.2kbps)	
	Intelligent input terminals	11 terminals (A or B terminal accept a pulse train)		
FW(Forward rotation)/RV(Reverse rotation), CF1 to CF4(Multi speed 1 to 4), SF1 to SF7(Multi speed Bit 1 to 7), ADD(Trigger for frequency addition), SCHG(Main/Sub speed reference change), STA(3-wire start)/STP(3-wire stop)/ F/R(3-wire Forward/Reverse), AHD(Analog command holding), FUP(Remote speed up)/FDN(Remote speed down)/UDC(Remote speed data clearing), F-OP(Force operation), SET(2nd-motor), RS(Reset), JG(Jogging), DB(External Dynamic brake), 2CH(2-stage Accel/Decel), FRS(Free-run stop), EXT(External fault), USP(Unattended start protection), CS(Commercial power supply change), SFT(Soft lock), BOK(Answer back from Brake), OLR(Overload restriction selection), KHC(Accumulation input power clearance), OKHC(Accumulation output power clearance), PID to PID4(PID1 to PID4 disable), PIDC to PIDC4(PID1 to PID4 integration reset), SVC1 to 4(PID1 Multi set-point 1 to 4), PRO(PID gain change), PIO1/2(PID output switching 1/2), SLEEP(SLEEP condition activation)/WAKE(WAKE condition activation), TL(Torque limit enable), TRQ1/2(Torque limit selection1/2), PPI(P/PI control mode selection), CAS(Control gain change), SON(Servo-ON), FOC(Forcing), ATR(Permission of torque control), TBS(Torque bias enable), ORT(Home search function), LAC(Accel/Decel cancellation), PCLR(Clearance of position deviation), STAT(Pulse train position reference input enable), PUP(Position bias (ADD)), PDN(Position bias (SUB)), CP1 to CP4(Multistage position 1 to 4), ORL(Limit signal of Homing), ORG(Start signal of Homing), FOT(Forward over travel), ROT(Reserve over travel), SPD(Speed/position switching), PSET(Position data presetting), Mi1 to 11(General-purpose input 1 to 11), PCC(Pulse counter clearing), ECOM(EzCOM activation), PRG(Program RUN), HLD(Accel/Decel disable), REN(RUN enable), DISP(Display lock), PLA(Pulse count A), PLB(Pulse count B), EMF(Emergency-force drive activation), COK(Contactor check), DTR(Data trace start), PLZ(Pulse train input Z), TCH(Teach-in)				
Backup supply terminal		P+/P-: 24 VDC input (Input allowable voltage: 24 VDC ±10%)		
Functional safety STO input terminal		2 terminals (Simultaneous input)		
Thermistor input terminal	1 terminal (PTC / NTC resistor allowed)			
Output	Intelligent output terminals	Transistor output terminal 5, 1a contact relay 1 point, 1c contact relay 1 point		
	Relay/ Alarm relay (1a, 1c) function	RUN(Running), FA1 to 5(Frequency reached signals), IRDY(Inverter ready), FWR(Forward rotation), RVR(Reverse rotation), FREF(Frequency reference = Keypad is selected), REF(Run command = Keypad is selected), SETM(2nd-motor selected), OPO(Option Output), AL(Alarm), MJA(Major failure), OTQ(Over torque) (*7), IP(Instantaneous power failure), UV(Undervoltage), TRQ(Torque limited), IPS(IP-Non stop function is active), RNT(Accumulated RUN time over), ONT(Accumulated power-on time over), THM(Electronic thermal alarm (Motor)), THC(Electronic thermal alarm (Inverter)), WAC(Capacitor life warning), WAF(Cooling-fan speed drop), FR(RUN command active), OHF(Heat sink overheat warning), LOC/LOC2(Low-current indication 1/2), OL/OL2(Overload warning notice 1/2), BRK(Brake release), BER(Brake error), CON(Contactor control), ZS(Zero speed detection), DSE(Speed deviation over), PDD(Position deviation over), POK(Positioning completed), PCMP(Pulse counter compare match output), OD/OD2/OD3/OD4(Over deviation for PID1 to 4 control), FBV/FBV2/FBV3/FBV4(PID1to 4 feedback comparison), NDC(Communication line disconnection), Ai1Dc/Ai2Dc/Ai3Dc/Ai4Dc/Ai5Dc/Ai6Dc (Analog Ai1 to Ai6 disconnection detection),WCAi1/WCAi2/ WCAi3/ WCAi4/ WCAi5/WCAi6 (Window comparator Ai1 to Ai6), LOG1 to 7(logical operation result 1 to 7), MO1 to 7(General-purpose output 1 to 7), EMFC(Emergency force drive indicator), EMBP(Bypass mode indicator), WFT(Trace function waiting for trigger), TRA(Trace function data logging), LBK(Low battery of keypad), OVS(Overvoltage power Supply), AC0 to 3(Alarm code bit-0 to 3), SSE(PID soft start error)		
		EDM output terminal	Functional safety diagnostic output	
	Output terminal monitor (*8)	The data of the monitor can be selected by the parameter of the output.		
EMC filter (*9)		EMC filter can be enable (The filter exchange method can alter depending on the model)		
PC external access		USB Micro-B		
Operating environment	Ambient temperature (*10)	-10 to 50°C (ND), -10 to 45°C (LD), -10 to 40°C (VLD)		
	Storage temperature (*11)	-20 to 65°C		
	Level of humidity	20 to 90%RH(No condensation allowed)		
	Vibration tolerance (*12)	5.9m/s ² (0.6G), 10 to 55Hz	P1-00044-L(P1-004L) to P1-01240-L(P1-220L)/P1-00041-H(P1-007H) to P1-00620-H(P1-220H)	
		2.94m/s ² (0.3G) 10 to 55Hz	P1-01530-L(P1-300L) to P1-03160-L(P1-550L)/P1-00770-H(P1-300H) to P1-06600-H(P1-3150H)	
Installation place (*13)	1000 altitude or lower (location free from corrosive gas, oil mist, and dust)			

Common specifications

Items	General Specifications
Components life span	The design life of the electrolytic capacitor on the board and the main circuit smoothing capacitor is 10 years.
	The design life of the cooling fan is 10 years (models with cooling fan). But no dust.
	Non-volatile memory parts on control circuit board.
	The design life of the LCD backlight in Keypad (VOP) is 10 years (8hr/day at 100% dimming, 30% brightness reduction)
Conformity standards	UL, cUL, CE marking, RCM
Functional safety (*14)	STO function/ IEC61800-5-2,IEC62061,IEC61508: SIL3/ EN ISO13849-1: Cat.4 PLe
Coating color	Black (P1-1600HFF and above models are unpainted (except front cover and terminal block cover painted black))
Optional slots	3 ports
Option cassettes (*15)	• Communication option : Ethernet(Modbus-TCP)(P1-EN), EtherCAT® (P1-ECT), PROFINET® (P1-PN), PROFIBUS® (P1-PB), CC-Link® (P1-CCL), DeviceNet® (P1-DN)
	• Encoder Feedback option (Line driver input(RS422))(P1-FB) • Functional safety option(P1-FS)(STO/SS1/SBC/SLS/SDI/SSM function/ IEC61800-5-2,IEC62061, IEC61508:SIL3/EN ISO13849-1:Cat.4 PLe) • Analog input/output option (P1-AG)
Other optional components	Braking resistor, AC reactor, DC link Choke, Noise filter, Operator cable, Harmonics suppression unit, LCRfilter, Analog operation panel, Regenerative braking unit, Power regeneration converter, SJ300/L300P/SJ700/L700 compatible screw type control terminal block option(P1-TM2 / P1-TM2R), Inverter Configuration Software ProDriveNext.

*1) Output frequency range will depend on the motor control method and the motor used. Consult the motor manufacturer for the maximum allowable frequency of the motor when operating beyond 60Hz.

*2) In case of the control mode is changed and the motor constant is not set appropriately, the desired starting torque cannot be obtained and also exists the possibility of tripping.

*3) Regarding the speed range regulation of motor, the variable range depends on the client system and the environment in which the motor is used. Please contact Hitachi inverter distributors for more information.

*4) Both the input power and output power are reference values, which are not appropriate for use in calculation of efficiency values, etc. To obtain an accurate value, use an external device.

*5) If the IGBT error [E030] occurs by the protective function, it may have happened by the short-circuit protection, but also can occur if the IGBT is damaged. Depending on the operation status of the inverter, instead of the IGBT error, the overcurrent error [E001] may also occur.

*6) At factory setting, the maximum output frequency for analog input signal Ai1/Ai2 is adjusted to 9.8 VDC for voltage input and 19.8mA for current input.

*7) The threshold for signal output varies depending on the motor to be combined with the inverter, parameter adjustment, etc.

*8) The analog voltage and analog current monitor are estimated outputs of the analog meter connection. Maximum output value might deviate slightly from 10V or 20mA by variation of the analog output circuit. If you want to change the characteristics, adjust the Ao1 and Ao2 adjustment functions. There are some monitor data that cannot be output.

*9) In order to enable the EMC filter, connect to the neutral grounding supply. Otherwise, the leakage current may increase.

*10) Use the 400V class inverter at an input voltage of 500 VAC or below. If input voltage exceeds 500 VAC due to fluctuation of power, use the inverter at 40°C or lower ambient temperature.

*11) Storage temperature is the temperature during transport.

*12) In accordance with the test methods of JIS C 60068-2-6:2010(IEC 60068-2-6:2007).

*13) In case of utilization at an altitude of 1000m or more, take into account that the atmospheric pressure is reduced by 1% for every 100m up. Apply 1% current derating from the rated current by increasing every 100m, and conduct an evaluation test. When using above 2500m ambient, please contact Hitachi Inverter distributor.

*14) The functional safety certification models are P1-00044-L(P1-004L) to P1-02950-L(P1-550L)/P1-00041-H(P1-007H) to P1-03160-H(P1-1320H). In addition, the certification models for the functional safety option P1-FS are also the same models.

*15) Modbus® is a trademark and the property of Schneider Electric SE, its subsidiaries and affiliated companies. EtherCAT® is registered trademark and patented technology, licensed by Beckhoff Automation GmbH, Germany. PROFIBUS® and PROFINET® is registered trademark of PROFIBUS Nutzerorganisation e.V. (PNO). CC-Link® is trade names of Mitsubishi Electric Co. DeviceNet® is the trademark of Open DeviceNet Vendor Association, Inc.

Protective Functions

Name	Cause (s)	Trip code
Overcurrent error	The inverter output was short-circuited, or the motor shaft is locked or has a heavy load. These conditions cause excessive current for the inverter, so the inverter output is turned OFF. The protection circuit operates at approximately 220%(Parameter setting changeable) of the rated output current (ND rated).	E001
Motor overload error(*1)	When a motor overload is detected by the electronic thermal function, the inverter trips and turns off its output.	E005
Braking resistor overload error	When the regenerative braking resistor exceeds the usage time allowance or an over-voltage caused by the stop of the BRD function is detected, the inverter trips and turns off its output.	E006
Overvoltage error	When the DC bus voltage exceeds a threshold, due to regenerative energy from the motor, the inverter trips and turns off its output.	E007
Memory error(*2)	When the built-in memory element has problems due to noise or excessive temperature, the inverter trips and turns off its output.	E008
Under-voltage error(*3)	In case the inverter DC voltage drops under the specified threshold voltage, the output will be shut down since the control circuit functions may not work properly. This trip will occur when the DC voltage drops under 160 VDC for 200V class or 320 VDC for 400V class inverters.	E009
Current detector error	If a strong source of electrical interference is close to the inverter or abnormal operations occur in the built-in CT, the inverter trips and turns off its output.	E010
CPU error(*4)	When a malfunction in the built-in CPU has occurred, the inverter trips and turns off its output.	E011
External trip error	When a signal to an intelligent input terminal configured as EXT has occurred, the inverter trips and turns off its output.	E012
USP error	This trip will occur if the inverter is in RUN mode when it is turned on(Only when the USP function is enabled).	E013
Ground fault error(*4)	The inverter is protected by the detection of ground faults between the inverter output and the motor during power-up tests. This feature protects the inverter only.	E014
Power supply overvoltage error	When the input voltage is higher than the specified value, it is detected in 100 seconds after power-up and then the inverter trips and turns off its output. The overvoltage detection levels are about 390 VDC (200V class) and 780 VDC (400V class) between PN. (Parameter changeable).	E015
Instantaneous power failure error	When the inverter power is cut the inverter trips and its output is turned off. Also in case the inverter is configured to restart after recovering from this trip and the RUN command still on, then the inverter output will restart automatically after recovery. Additionally, in case the power is cut for a long time then it will be considered as the inverter was normally shut down.	E016
Temperature detector error	This trip will occur in case abnormalities in the temperature sensor circuit are detected.	E019
Cooling fan rotation speed reduction temperature error	This trip will occur in case the temperature error(high temperature) is detected when the cooling fan rotation is low.	E020
Temperature error	When the inverter internal temperature is higher than the specified value, the thermal sensor in the inverter module detects the higher temperature of the power devices and trips, turning off the inverter output.	E021
Input open-phase error(*5)	One of three lines of 3-phase power supply is missing. Decision time is about 1s. (When the input phase loss effective function is enabled).	E024
IGBT error(*6)	When an instantaneous over-current has occurred, the inverter trips and turns off its output to protect main circuit element.	E030
Output open-phase error(*7)	One of three lines of 3-phase power output is missing. Decision time is about 1s. (When the output phase loss effective function is enabled).	E034
Thermistor error	When the thermistor inside the motor detects temperature higher than the specified value, the inverter trips and turns off its output.	E035
Brake error	The inverter turns off its output when it can not detect whether the braking is ON or OFF within waiting time after it has released the brake. (When braking function is enabled.)	E036
Low-speed range overload error	If overload occurs during the motor operation at a very low speed at 0.2Hz or less, the electronic thermal protection function in the inverter will detect the overload and shut off the inverter output. (Note that a high frequency may be recorded as the error history data.)	E038
Controller overload error(*1)	When the inverter itself overload is detected by the electronic thermal function, the inverter trips and turns off its output.	E039
RS-485 communication error	If timeout occurs because of line disconnection during the communication in Modbus-RTU mode, the inverter will display the error code shown on the right.	E041
EzSQ invalid instruction error	This trip occurs when an invalid instruction is detected in EzSQ program.	E043
EzSQ nesting count error	This trip will occur when an EzSQ program exceeded the maximum allowed nesting count number.	E044
EzSQ execution error	This trip occurs when an impossible instruction is detected in EzSQ program.	E045
EzSQ user-assigned error(0 to 9)	These trips occur when a user specified trip instruction is executed in the program.	E050 to E059
STO related errors(Safety option) (*8)	For more information, please refer to the P1 safety function guide.	E090 to E093

*1: The inverter can only be reset 10 seconds after the overload protection trip occurred(The occurrence of this trip will also depend on the parameter settings).

*2: Reset operation by reset terminal or STOP / RESET key is not accepted. Since memory element failure or parameter may not be stored correctly, Please initialize memory after turning on the power supply again. And Please re-setting parameters.

*3: Undervoltage error output may take up to about 1sec.

*4: Reset operation by reset terminal or STOP / RESET key is not accepted. Please turn off the power of the inverter.

*5: When the input power supply waveform is distorted, error detection may not be performed correctly.

*6: This protection does not protect the output short circuit, so there is a risk of IGBT damage.

*7: Depending on the state of the output current, it may not be detected correctly.

*8: Inverter repair is necessary when E091 error occurs. Please contact your service or sales dept.

Dimensions

- P1-00044-LF□F to 00228-LF□F
- P1-00041-HF□F to 00126-HF□F

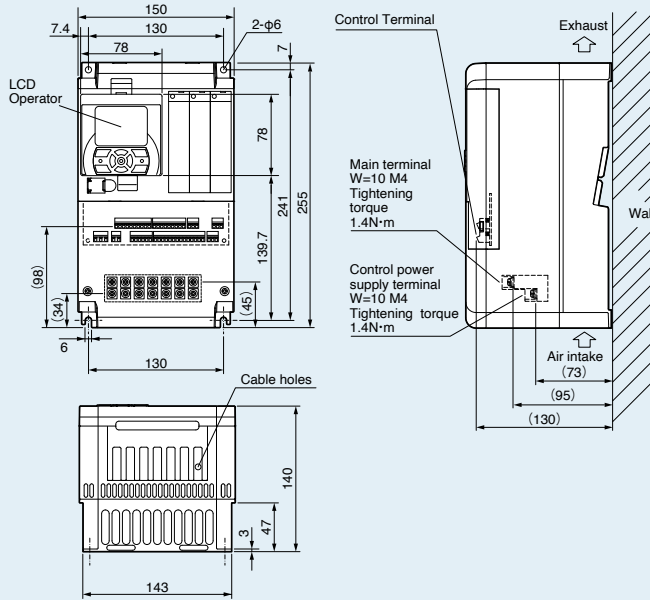

- P1-00330-LF□F, P1-00460-LF□F
- P1-00175-HF□F, P1-00250-HF□F

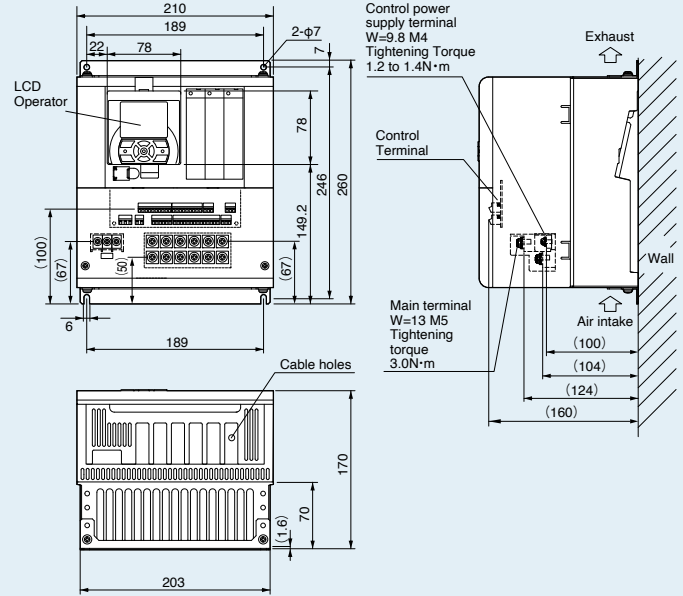

- P1-00600-LF□F
- P1-00310-HF□F

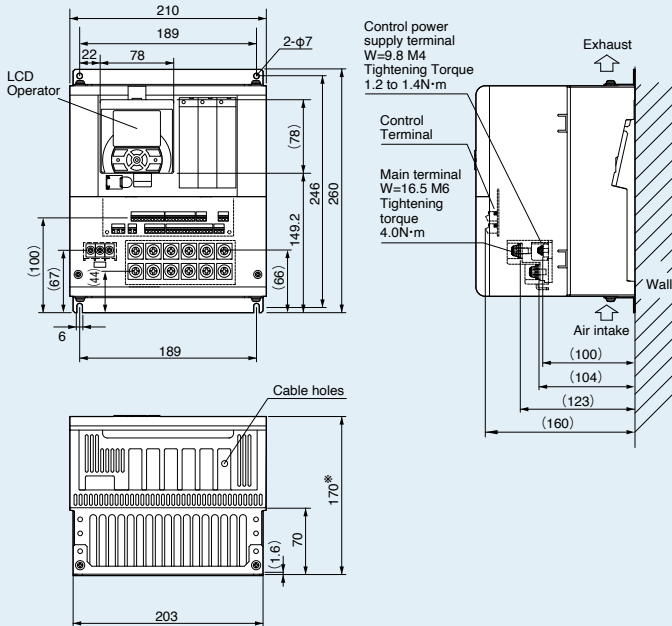

- P1-00800-LF□F, P1-00930-LF□F, P1-01240-LF□F

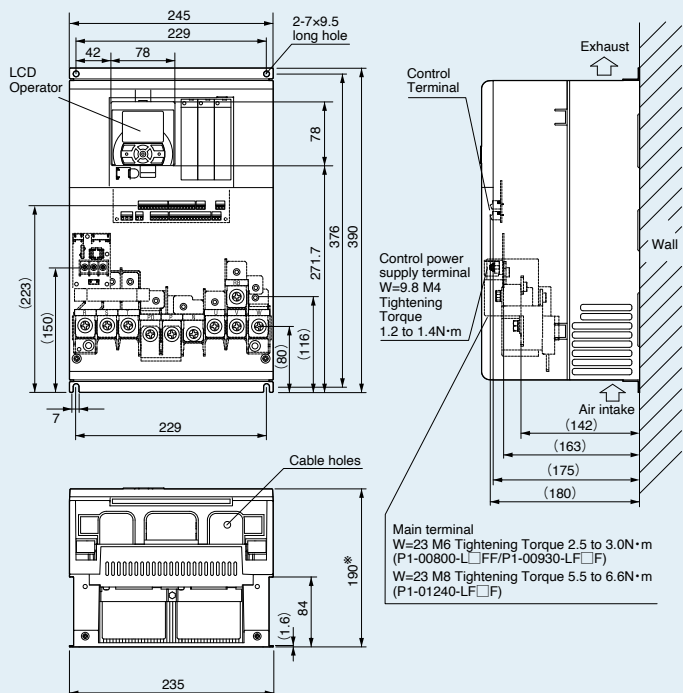

[Unit:mm]

※When using P1-00600-LFF with LD/VLD rating, the dimension D increases by 15mm.
When using P1-01240-LFF with VLD rating, the dimension D increases by 10mm.

• P1-00400-HF□F, P1-00470-HF□F, P1-00620-HF□F

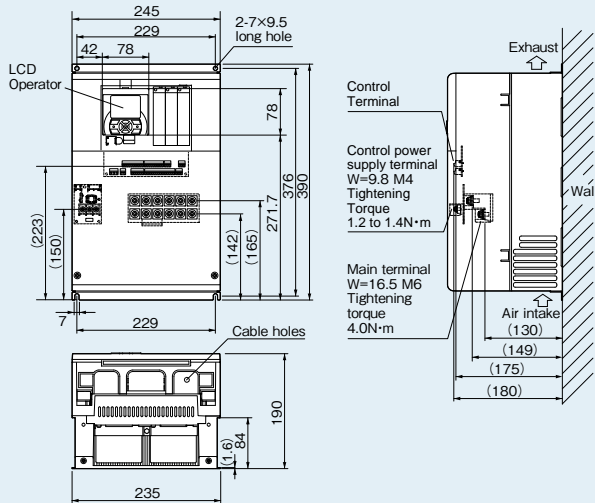

• P1-01530-LF□F • P1-00770-HF□F

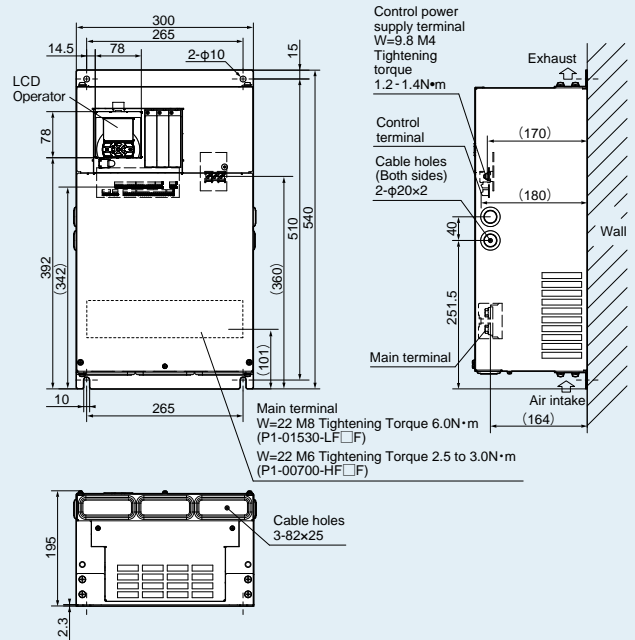

• P1-01850-LF□F, P1-02290-LF□F
• P1-00930-HF□F, P1-01160-HF□F, P1-01470-HF□F

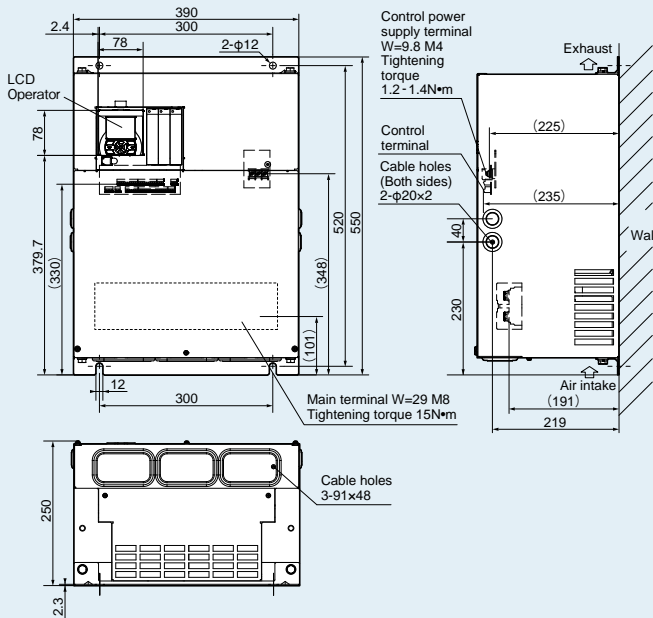

• P1-02950-LF□F

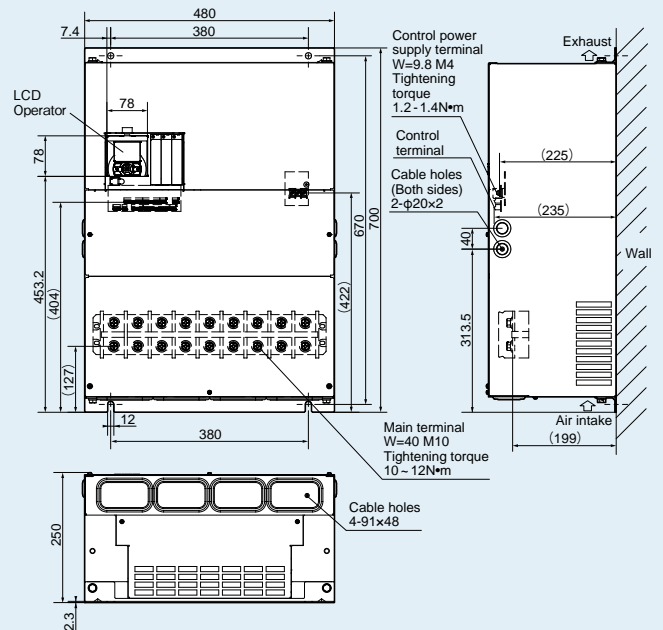

[Unit : mm]

• P1-01760-HF□F, P1-02130-HF□F

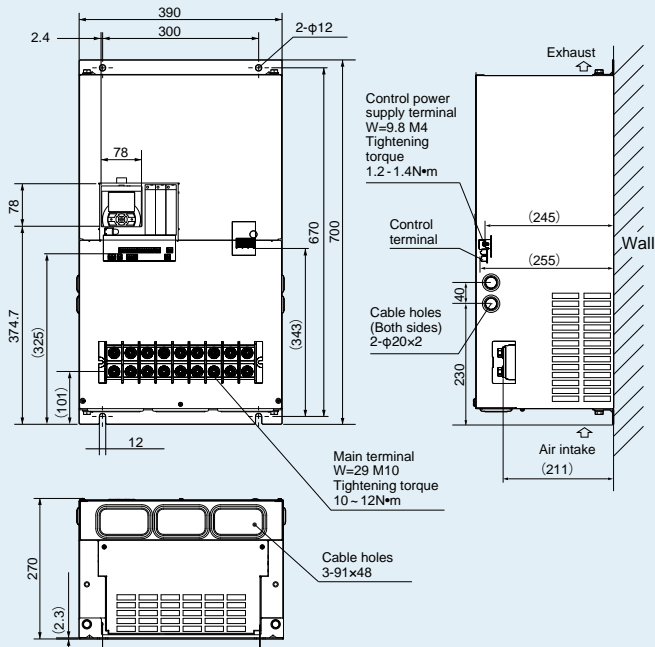

• P1-02520-HF□F, P1-03160-HF□F

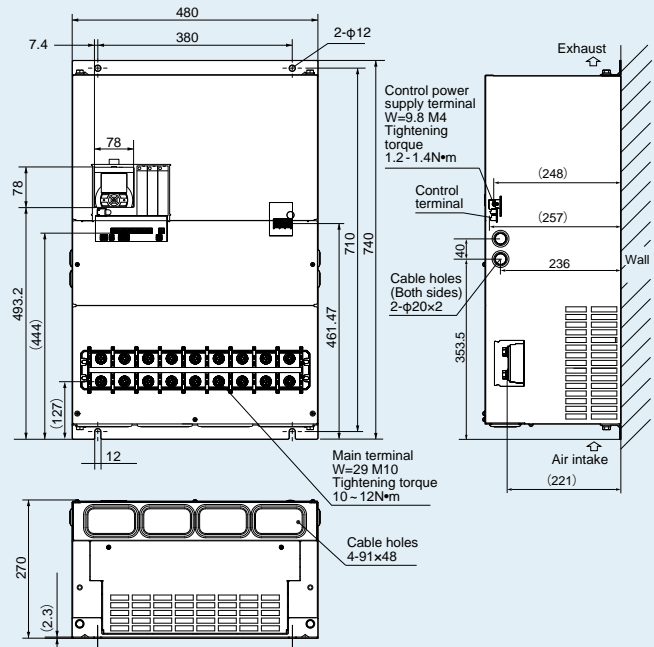

• P1-03720-HF□F

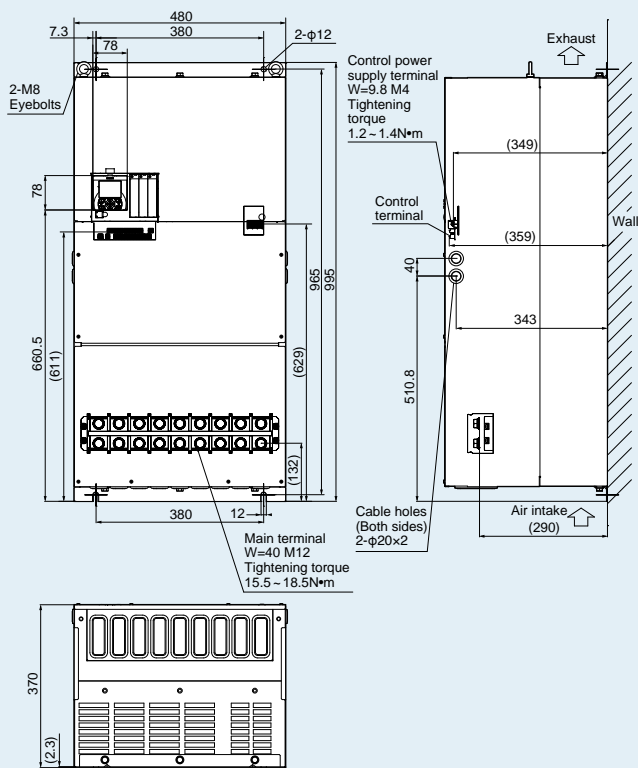

• P1-04320-HF□F

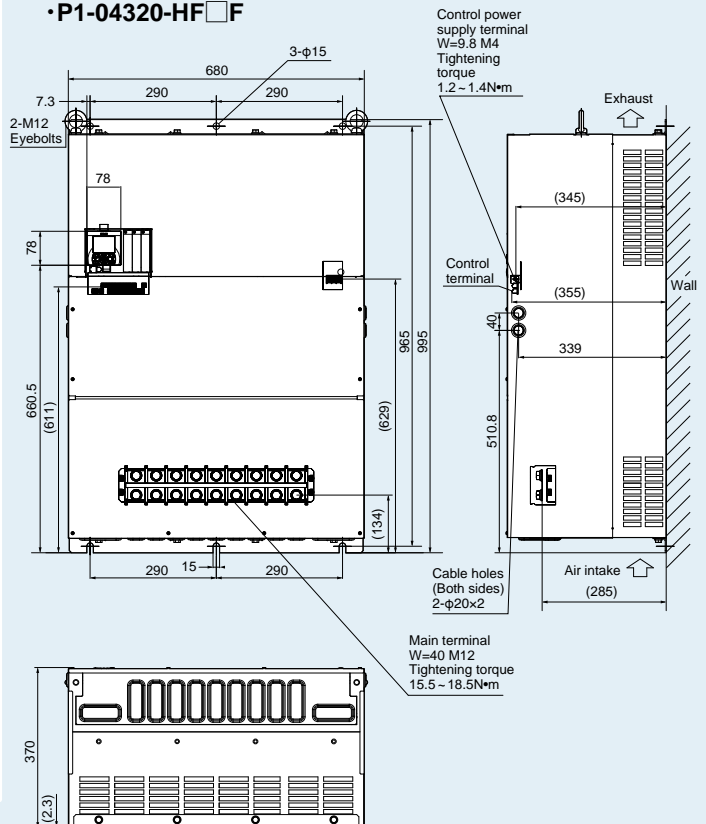

[Unit : mm]

•P1-04860-HF□F, •P1-05200-HF□F

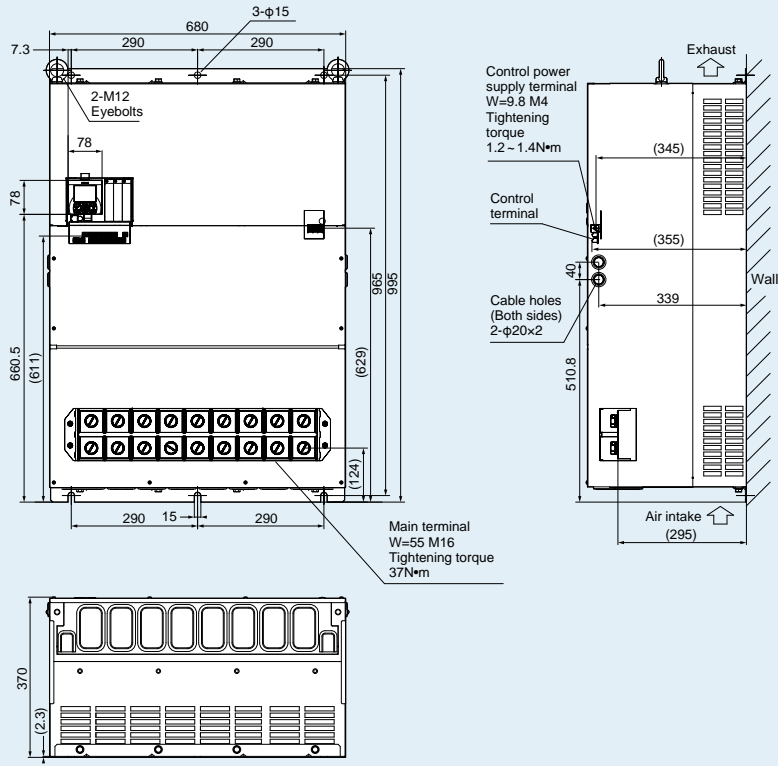

•P1-05500-HF□F

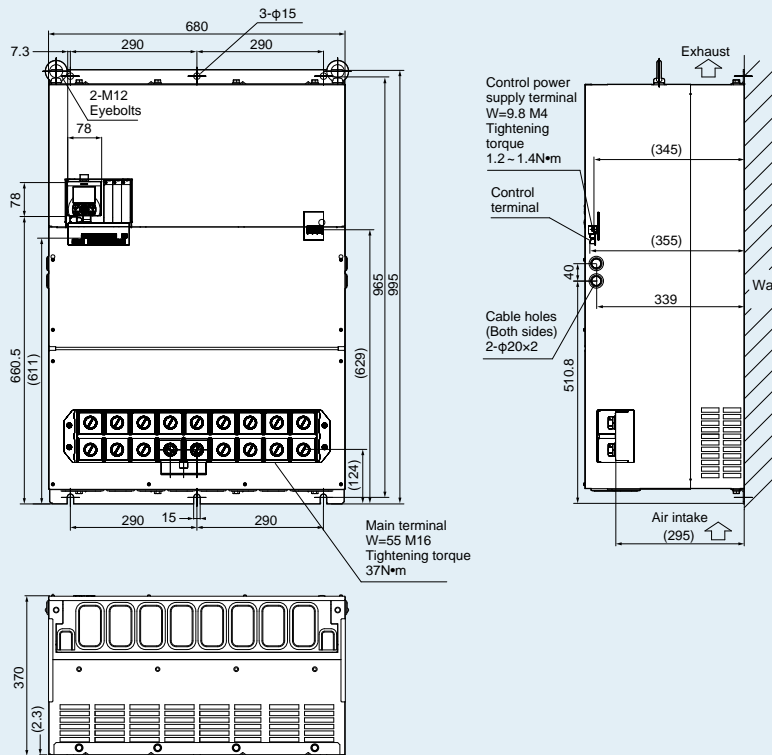

[Unit : mm]

Dimensions

•P1-06600-HF□F

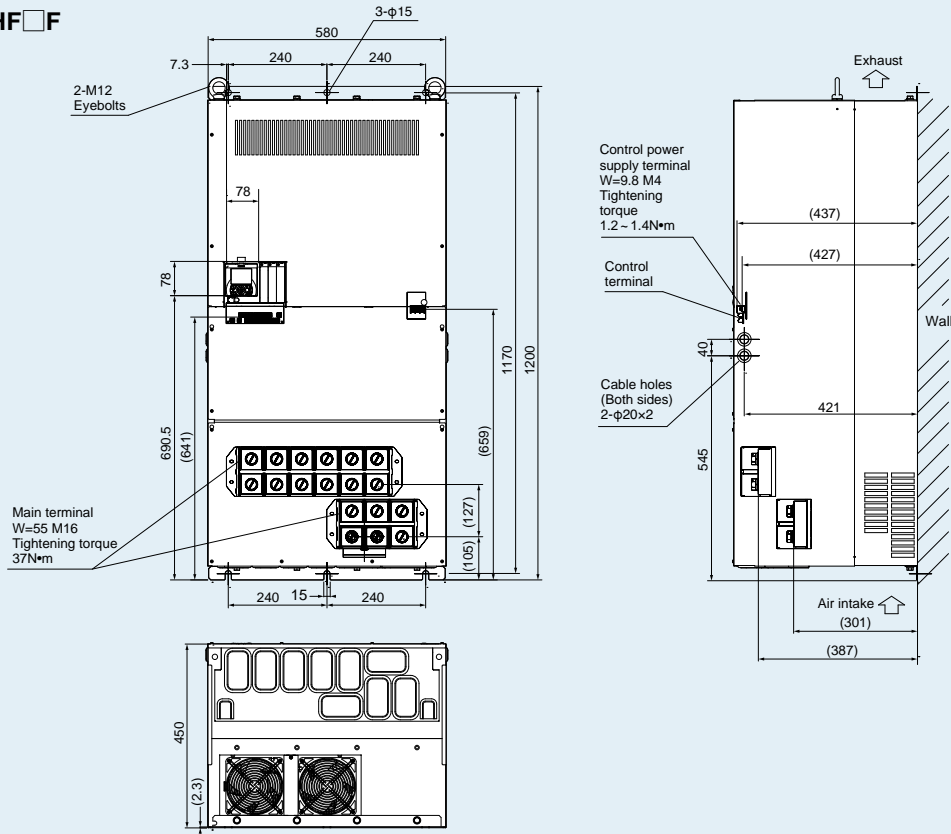

[Unit : mm]

Main Circuit Terminals

Terminal Description

Terminal Symbol	Terminal Name	Terminal Symbol	Terminal Name
R/L1, S/L2, T/L3	Input terminal for main power supply	P/+, N/-	Regenerative braking unit connection terminal
U/T1, V/T2, W/T3	Inverter output terminal	G	Inverter ground terminal
PD/+1, P/+	DC link choke connection terminal	R0, T0	Input terminal for control circuit power supply
P/+, RB	External chopper braking resistor connection terminal		

Screw Diameter and Terminal Width

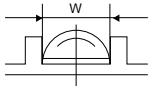

W:Terminal width

Model	Screw diameter	Ground Screw diameter	Terminal width (mm)	Terminal Arrangement
P1-00044-LFF to P1-00228-LFF / P1-00041-HFF to P1-00126-HFF	M4	M4	10	Figure 1
P1-00330-LFF, P1-00460-LFF / P1-00175-HFF, P1-00250-HFF	M5	M5	13	Figure 2
P1-00600-LFF, P1-00310-HFF	M6	M6	16.5	Figure 2
P1-00800-LFF, P1-00930-LFF	M6	M6	23	Figure 3
P1-01240-LFF	M8	M6	23	Figure 3
P1-00400-HFF to P1-00620-HFF	M6	M6	16.5	Figure 4
P1-01530-LFF	M8	M6	22	Figure 5
P1-01850-LFF, P1-02290-LFF	M8	M8	29	Figure 5
P1-02950-LFF	M10	M8	40	Figure 5
P1-00770-HFF	M6	M6	22	Figure 6
P1-00930-HFF to P1-01470-HFF	M8	M8	29	Figure 6
P1-01760-HFF, P1-02130-HFF	M10	M8	29	Figure 7
P1-02520-HFF, P1-03160-HFF	M10	M8	40	Figure 5
P1-03720-HFF, P1-04320-HFF	M12	M12	40	Figure 5
P1-04860-HFF to P1-05500-HFF	M16	M12	55	Figure 5
P1-06600HFF	M16	M12	55	Figure 8

Terminal Arrangement

Figure 1 P1-00044-L to P1-00228-L / P1-00041-H to P1-00126-H

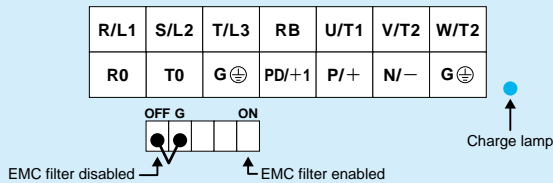

Figure 2 P1-00330-L to P1-00600-L / P1-00175-H to P1-00310-H

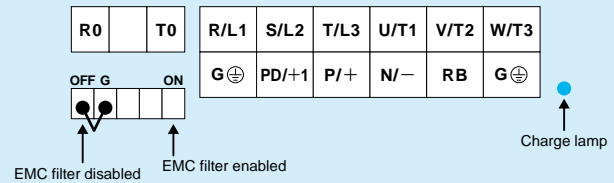

Figure 3 P1-00800-L, P1-01240-L

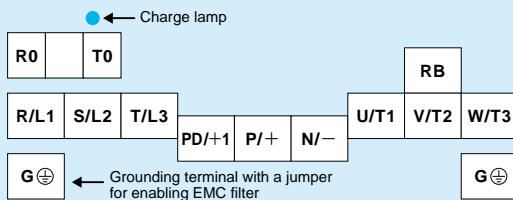

Figure 4 P1-00400-H to P1-00620-H

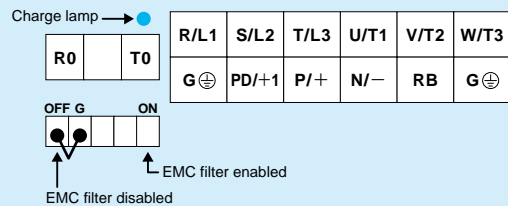

Figure 5 P1-01530-F to P1-02950-L / P1-02520-H to P1-05500-H

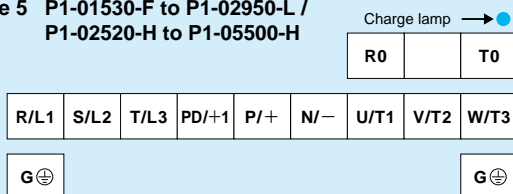

Figure 6 P1-00770-H to P1-01470-H

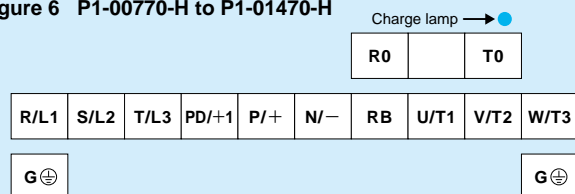

Figure 7 P1-01760-H, P1-02130-H

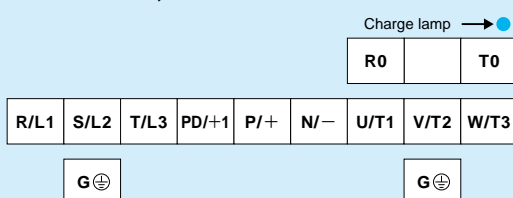
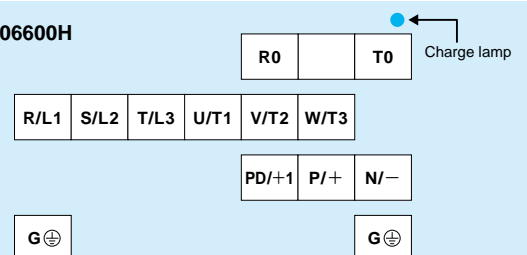
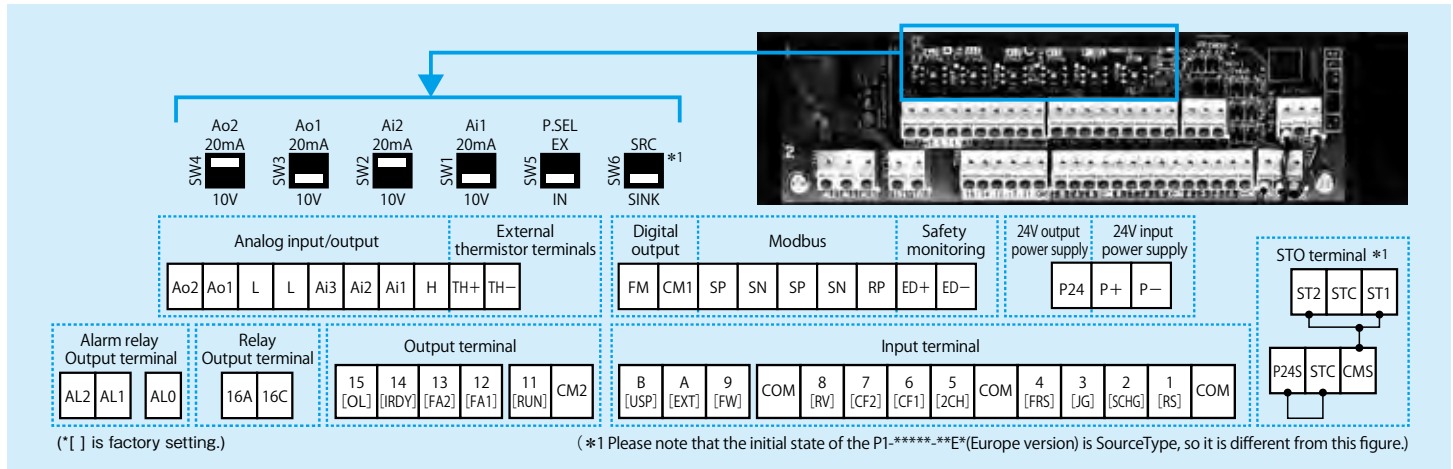

Figure 8 P1-06600H



Control Circuit Terminals

Terminal Arrangement



Configuration of switches

Indication	Name of switch	Description
Ai1(SW1)	Analog input 1 switch	Switches input specification of analog input 1 (Ai1 terminal). 10V: Voltage input is available. 20mA: Current input is available.
Ai2(SW2)	Analog input 2 switch	Switches input specification of analog input 2 (Ai2 terminal). 10V: Voltage input is available. 20mA: Current input is available.
Ao1(SW3)	Analog output 1 switch	Switches output specification of analog output 1 (Ao1 terminal). 10V: Output changes to voltage output. 20mA: Output changes to current output.
Ao2(SW4)	Analog output 2 switch	Switches output specification of analog output 2 (Ao2 terminal). 10V: Output changes to voltage output. 20mA: Output changes to current output.
P.SEL(SW5)	Switching the method of power supply to the input terminals	Switches the method of power supply to the input terminals. IN: Drives the input terminals using the internal power supply. EX: Inputs an external power supply to drive input terminals. (In the case of EX, a power supply is required between the input terminals and COM.)
SRC/SINK(SW6)	Switch of sink/source for the input terminals	Switches the sink/source logic for input terminals. This switch is enabled when SW5 is IN. SINK: Enables sink logic. SRC: Enables source logic.

Terminal Description

	Symbol	Terminal name	Description	Electric characteristics		
Voltage/current switchable analog input/output terminal	Power supply	L	Analog power common	Common terminals for analog input terminals (Ai1, Ai2, Ai3) and analog output terminals (Ao1, Ao2). There are two L terminals.	Allowable load current is 20mA or less	
		H	Power supply for setting speed	This is a 10 VDC power supply. It is used when using analog input terminals (Ai1, Ai2, Ai3) and variable resistor for inputting voltage.		
	Analog input	Ai1	Analog input terminal 1 (Voltage/current switching SW1)	For Ai1 and Ai2, 0 to 10 VDC voltage input or 0 to 20mA current input can be switched using a switch. It can be used for input frequency command or feedback.	For voltage input: • Input impedance approx. 10kΩ • Allowable input voltage -0.3 to 12 VDC For current input: • Input impedance approx. 100Ω • Max. allowable input current 24mA	
		Ai2	Analog input terminal 2 (Voltage/current switching SW2)			
		Ai3	Analog input terminal 3	-10 to 10 VDC voltage input is available. It can be used for input frequency command or feedback.	Voltage input only: • Input impedance approx. 10kΩ • Allowable input voltage -12 to 12 VDC	
	Analog output	Ao1	Analog output terminal 1 (Voltage/current switching SW3)	For Ao1 and Ao2, 0 to 10 VDC voltage output or 0 to 20mA current output can be switched using a switch as output of information monitor data of the inverter.	For voltage output: • Max. allowable output current 2mA • Output voltage accuracy ±10% (Ambient temperature: 25±10°C)	
Ao2		Analog output terminal 2 (Voltage/current switching SW4)	For current output: • Allowable load impedance 250Ω or below • Output current accuracy: ±20% (Ambient temperature: 25±10°C)			
24V power supply	Input / output	P24	24V output power terminal	This terminal supplies 24 VDC power for contact signals. CM1 terminal is common for P24 terminal.	Max. output 100mA	
		P+	External 24V power supply input terminal (24 VDC)	With this 24 VDC power supply, it is possible to read and write parameters, I/O inputs and outputs, communicate with options, etc. without power supply to the main circuit R,S,T terminals and the control circuit R0,T0 terminals.	Allowable input voltage 24 VDC±10% Max. power consumption 1A	
		P-	External 24V power supply input terminal (0 VDC)			
Intelligent input terminal	Digital input	Contact	9	Input terminal	Each terminal can select input terminal functions by parameter setting. Switch the SINK / SRC of SW6 to select the sink logic and source logic.	• Max. allowable voltage 27 VDC • Load current 5.6mA(at 27 VDC) Voltage between each input and the COM terminal: When using an external power supply: • ON voltage Min. 18 VDC • OFF voltage Max. 3 VDC When using the internal power supply: • ON voltage Max. 3 VDC • OFF voltage Min. 18 VDC
			8			
			7			
		Contact/pulse	A	Pulse input-A	These are terminals for pulse train input. The maximum input pulse is 32 kpps.	• Maximum 32kpps pulse input (When terminal A and B function is pulse train input A/B)
B	Pulse input-B		A and B terminals can also be used as input terminals. Each terminal can select input terminal functions by parameter setting.			

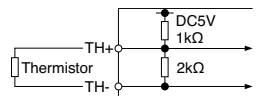
			Symbol	Terminal name	Description	Electric characteristics
Intelligent input terminal	Digital input	Common	COM	Input (common)	This is a common terminal for digital input terminals (1,2,3,4,5,6,7,8,9,A and B). Three COM terminals are available.	
Intelligent output terminal	Open collector		15 14 13 12 11	Output terminal	Terminal functions are selectable according to the parameter settings for each terminal. These are available for both Sink and Source logics.	Open collector output <ul style="list-style-type: none"> Between each terminal and CM2 Voltage drop at ON: 4 VDC or less Max. allowable voltage: 27 VDC Max. allowable current: 50mA
			CM2	Output (common)	This is a common terminal for output terminals 11 to 15.	
	Relay		16A 16C	1a relay terminal	Relays for A contact outputs	Maximum contact capacity <ul style="list-style-type: none"> 250 VAC, 2A(resistance) / 250 VAC, 1A(inductive load) 30 VDC, 3A(resistance) / 30 VDC, 0.6A(inductive load) Minimum contact capacity <ul style="list-style-type: none"> 5 VDC, 10mA
			AL0 AL1 AL2	1c relay terminal	Relays for C contact outputs	Maximum contact capacity AL1/AL0 : <ul style="list-style-type: none"> 250 VAC, 2A(resistance) / 250 VAC, 0.2A(inductive load) 30 VDC, 3A(resistance) / 30 VDC, 0.6A(inductive load) AL2/AL0 : <ul style="list-style-type: none"> 250 VAC, 1A(resistance) / 250 VAC, 0.2A(inductive load) 30 VDC, 1A(resistance) / 30 VDC, 0.2A(inductive load) Minimum contact capacity(common) <ul style="list-style-type: none"> 100 VAC, 10mA 5 VDC, 100mA
Digital output	Monitor output		FM	Digital monitor (voltage)	For digital monitor output, you can choose the PWM output method at 6.4ms interval or pulse output method with approx. 50% duty in which frequency varies.	Pulse train output 0 to 10 VDC <ul style="list-style-type: none"> Max. allowable current 1.2mA Max. frequency 3.60kHz
			CM1	Common for digital monitor	This is a common terminal for digital monitor.This is also used as 0V reference potential for P24.	
Thermistor terminal	Analog input		TH+	External thermistor input	When an external thermistor is connected, and resistance abnormality occurs due to abnormal temperature, etc., trip the inverter. Connect the thermistor with TH+ and TH-. The level of detecting resistance abnormality can be adjusted from 0 to 10000Ω. [Recommended thermistor characteristics] Allowable rated power: 100mW or more Impedance at abnormal temperature: 3kΩ	0 to 5 VDC[Input circuit] 
			TH-	Common for external thermistor		
RS485 communication	Serial communication		SP SN RP (CM1)	MODBUS terminal (RS-485)	SP terminal: RS-485 differential (+) signal SN terminal: RS-485 differential (-) signal RP terminal: Connect to SP through a terminating resistor CM1 terminal: Connect to the signal ground of external communication devices. (Used with the common terminal for FM output.) There are two SP terminals, which are connected internally for daisy chain connection. The SN terminals connection is same as the SP terminals. Max. baud rate is 115.2kbps.	Equipped with terminating resistor (120Ω) Enable: Short RP-SN Disable: Open RP-SN
STO terminal	Power supply for Safety		P24S	24V power supply terminal (STO dedicated terminal)	24V power supply dedicated for ST1/ST2 input. Not used when the STO input voltage is supplied from an external power supply.	24 VDC Max. allowable output current 20mA
			CMS	24V power supply common terminal (STO dedicated terminal)	Common for P24S	
			STC	Logic switching terminal	Sink / Source logic of input terminal can be configured. <Sink logic> Short-wire: Between P24S-STC <Source logic> Short-wire: Between CMS-STC * When the STO input voltage is supplied from an external power supply, remove the short-wire and STC terminal can be used as common terminal for ST1/ST2.	
	Input	STO functions	ST1	STO input1	STO signal input terminals	ST1-STC/ST2-STC voltage <ul style="list-style-type: none"> ON voltage Min. 15 VDC OFF voltage Max. 5 VDC Max. voltage 27 VDC Current 5.8mA (at 27 VDC)
			ST2	STO input2		
Monitoring	Open collector	ED+	EDM signal output terminal (+)	Positive terminal of EDM signal output (STO status monitor)	Open collector output between ED+ and ED-. <ul style="list-style-type: none"> Voltage drop when turned on:4V or less Max. allowable voltage 27V Max. allowable current 50mA 	
		ED-	EDM signal output terminal (-)	Negative terminal of EDM signal output (STO status monitor)		

Connecting Diagram

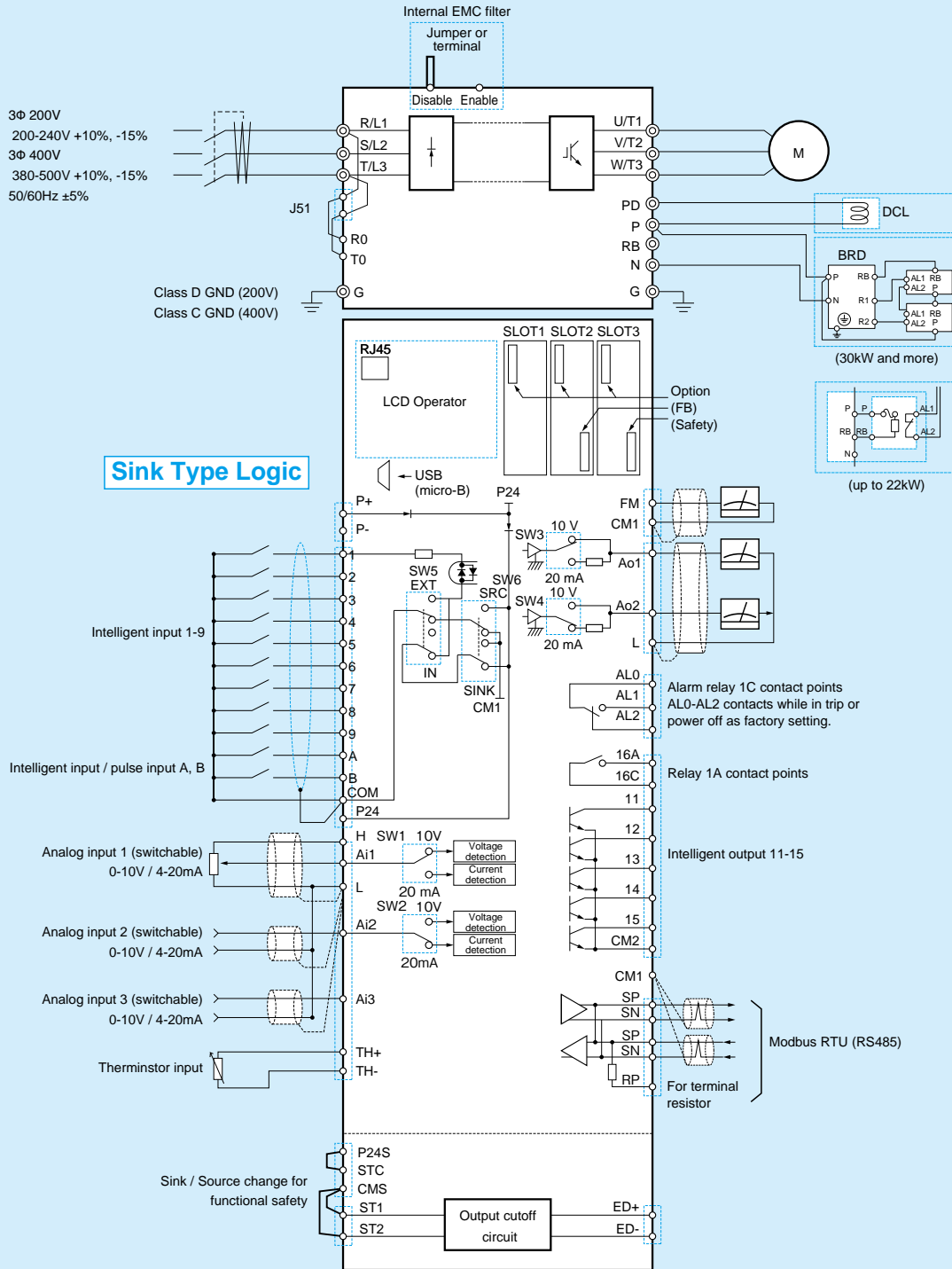

Note1: Common to each terminal varies.
 Note2: Disconnect J51 when to supply R0-T0 separately. UV error is issued when main supply is off while in operation.
 Note 3: Sink or source logic for input terminal is switched by SW6.

Connecting to PLC

• Connection with Input Terminals

1. Using Internal Power Supply of The Inverter

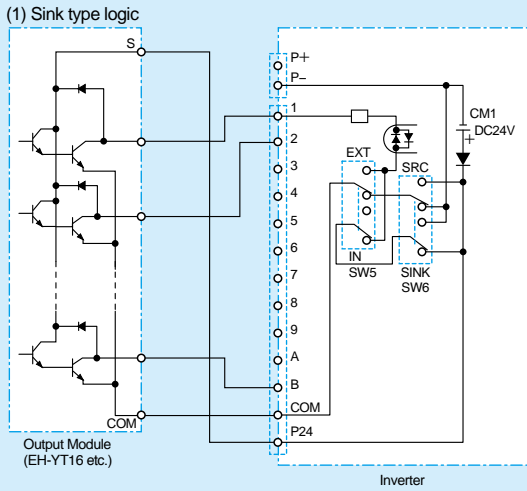

- When using internal power supply of the inverter, the SW5 to "IN".
- When connecting sink type module, the SW6 to "SINK".

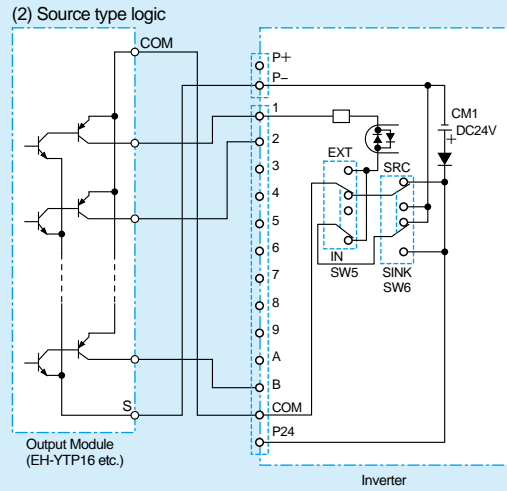

- When using internal power supply of the inverter, the SW5 to "IN".
- When connecting source type module, the SW6 to "SRC".

2.Using External Power Supply

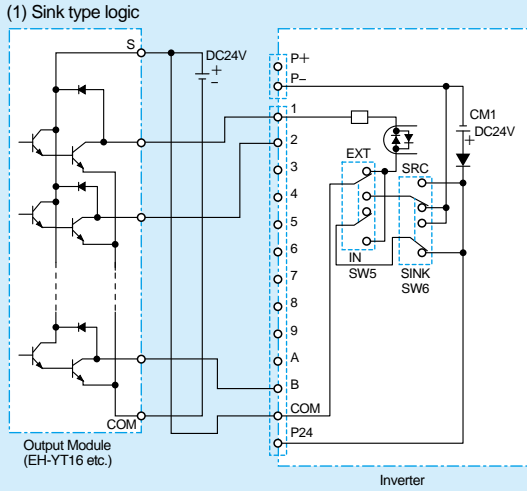

- When using external power supply, the SW5 to "EXT".
- When connecting sink type module, the SW6 to "SINK"

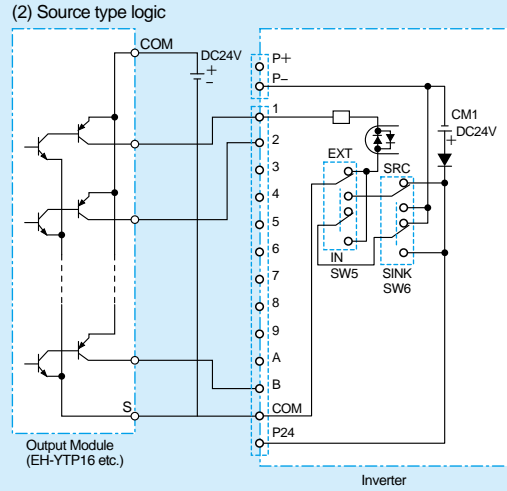

- When using external power supply, the SW5 to "EXT".
- When connecting source type module, the SW6 to "SRC".

(Note: Be sure to turn on the inverter after turning on the PLC and its external power source to prevent the parameters in the inverter from being modified.)

• Connection with Output Terminals

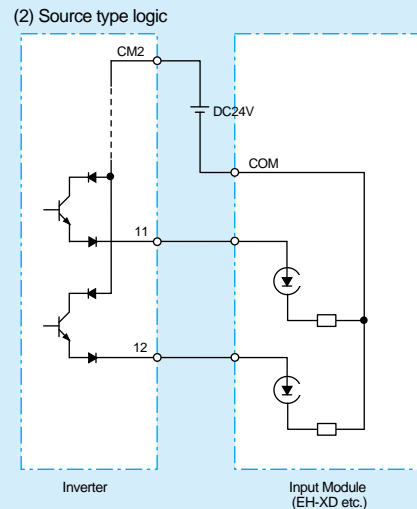
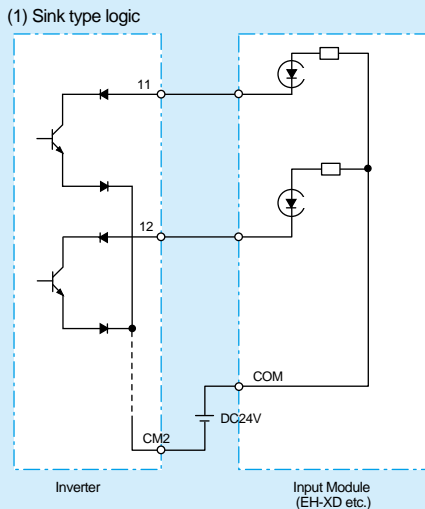

Function List

Monitor mode List

Code No.	Parameter Meaning	Selectable User Setting
dA-01	Output frequency monitor	0.00 to 590.00 (Hz)
dA-02	Output current monitor	0.00 to 655.35 (A) (Until P1-02950-L/P1-03160-H) 0.0 to 6553.5 (A) (Above P1-02950-L/P1-03160-H)
dA-03	Rotation direction monitor	0(Stop)/ 1(0Hz output)/ 2(Forward)/ 3(Reverse)
dA-04	Frequency reference monitor (after calculation)	-590.00 to 590.00 (Hz)
dA-06	Output frequency scale conversion monitor	0.00 to 59000.00
dA-08	Detect speed monitor	-590.00 to 590.00 (Hz)
dA-12	Output frequency monitor (signed)	-590.00 to 590.00 (Hz)
dA-14	Frequency upper limit monitor	0.00 to 590.00 (Hz)
dA-15	Torque reference monitor (after calculation)	-1000.0 to 1000.0 (%)
dA-16	Torque limit monitor	0.0 to 500.0 (%)
dA-17	Output torque monitor	-1000.0 to 1000.0 (%)
dA-18	Output voltage monitor (RMS)	0.0 to 800.0 (V)
dA-20	Current position monitor	-536870912 to +536870911 (pls) [Normal] -2147483648 to +2147483647 (pls) [H-Reso]
dA-26	Pulse train position deviation monitor	-2147483647 to 2147483647 (pls)
dA-28	Pulse count monitor	0 to 2147483647
dA-30	Input power monitor	0.00 to 655.35 (kW) (Until P1-02950-L/P1-03160-H) 0.0 to 6553.5 (kW) (Above P1-02950-L/P1-03160-H)
dA-32	Accumulated input power monitor	0.0 to 1000000.0 (kWh)
dA-34	Output power monitor	0.00 to 655.35 (kW) (Until P1-02950-L/P1-03160-H) 0.0 to 6553.5 (kW) (Above P1-02950-L/P1-03160-H)
dA-36	Accumulated output power monitor	0.0 to 1000000.0 (kWh)
dA-38	Motor temperature monitor	-20.0 to 200.0 (°C)
dA-40	DC bus voltage monitor	0.0 to 1000.0 (Vdc)
dA-41	BRD load rate monitor	
dA-42	Electronic thermal load rating monitor (Motor)	0.00 to 100.00 (%)
dA-43	Electronic thermal load rating monitor (Inverter)	
dA-45	Safety STO monitor	00(no input)/ 01(P-1A)/ 02(P-2A)/ 03(P-1b)/ 04(P-2b)/ 05(P-1C)/ 06(P-2C) 07(STO)
dA-46	Safety option hardware monitor	0000 to FFFF
dA-47	Safety option function monitor	00(no input)/ 01(STO)/ 02(SBC)/ 03(SS1)/ 04(SLS)/ 05(SDI)/ 06(SSM)
dA-50	Control terminal type	00(P1-TM)/ 02(P1-TM2 or P1-TM2R)/ 15(Not connect)
dA-51	Input terminal monitor	LLLLLLLLLLLL to HHHHHHHHHHHH [L-OFF/H-ON]
dA-54	Output terminal monitor	LLLLLLLL to HHHHHHHH [L-OFF/H-ON]
dA-60	Analog input/output status monitor	AAAAAAAA to VVVVVVVV [A: current/V: voltage]
dA-61	Analog input [Ai1] monitor	0.00 to 100.00 (%)
dA-62	Analog input [Ai2] monitor	
dA-63	Analog input [Ai3] monitor	-100.00 to 100.00 (%)
dA-64	Analog input [Ai4] monitor	
dA-65	Analog input [Ai5] monitor	0.00 to 100.00 (%)
dA-66	Analog input [Ai6] monitor	-100.00 to 100.00 (%)
dA-70	Pulse train input monitor (Internal)	-100.00 to 100.00 (%)
dA-71	Pulse train input monitor (Option)	-100.00 to 100.00 (%)
dA-81	Option slot-1 status	00(none)/ 01(P1-EN)/ 02(P1-ECT)/ 03(P1-PN)/ 05(P1-DN)/ 06(P1-PB)/ 07(P1-CCL)/ 18(P1-AG)
dA-82	Option slot-2 status	00(none)/ 01(P1-EN)/ 02(P1-ECT)/ 03(P1-PN)/ 05(P1-DN)/ 06(P1-PB)/ 07(P1-CCL)/ 18(P1-AG)/ 33(P1-FB)
dA-83	Option slot-3 status	00(none)/ 01(P1-EN)/ 02(P1-ECT)/ 03(P1-PN)/ 05(P1-DN)/ 06(P1-PB)/ 07(P1-CCL)/ 18(P1-AG)/ 48(P1-FS)
db-01	Program download monitor	00(Program is not installed)/ 01(Program is installed)
db-02	Program No. monitor	0000 to 9999
db-03	Program counter (Task-1)	
db-04	Program counter (Task-2)	
db-05	Program counter (Task-3)	1 to 1024
db-06	Program counter (Task-4)	
db-07	Program counter (Task-5)	
db-08	User monitor-0	
db-10	User monitor-1	
db-12	User monitor-2	-2147483647 to 2147483647
db-14	User monitor-3	
db-16	User monitor-4	
db-18	Analog output monitor YA0	
db-19	Analog output monitor YA1	
db-20	Analog output monitor YA2	
db-21	Analog output monitor YA3	0.00 to 100.00 (%)
db-22	Analog output monitor YA4	
db-23	Analog output monitor YA5	
db-30	PID1 feedback value 1 monitor	-100.00 to 100.00 (%)
db-32	PID1 feedback value 2 monitor	(Range will depend on the parameters [AH-04], [AH-05], [AH-06])
db-34	PID1 feedback value 3 monitor	
db-36	PID2 feedback value monitor	-100.00 to 100.00 (%) (Range will depend on the parameters [AJ-04], [AJ-05], [AJ-06])
db-38	PID3 feedback value monitor	-100.00 to 100.00 (%) (Range will depend on the parameters [AJ-24], [AJ-25], [AJ-26])
db-40	PID4 feedback value monitor	-100.00 to 100.00 (%) (Range will depend on the parameters [AJ-44], [AJ-45], [AJ-46])
db-42	PID1 target value monitor (after calculation)	-100.00 to 100.00 (%)
db-44	PID1 feedback value monitor (after calculation)	(Range will depend on the parameters [AH-04], [AH-05], [AH-06])
db-50	PID1 output monitor	-100.00 to 100.00 (%)

Code No.	Parameter Meaning	Selectable User Setting
db-51	PID1 deviation monitor	
db-52	PID1 deviation 1 monitor	
db-53	PID1 deviation 2 monitor	-200.00 to 200.00 (%)
db-54	PID1 deviation 3 monitor	
db-55	PID2 output monitor	-100.00 to 100.00 (%)
db-56	PID2 deviation monitor	-200.00 to 200.00 (%)
db-57	PID3 output monitor	-100.00 to 100.00 (%)
db-58	PID3 deviation monitor	-200.00 to 200.00 (%)
db-59	PID4 output monitor	-100.00 to 100.00 (%)
db-60	PID4 deviation monitor	-200.00 to 200.00 (%)
db-61	Current PID P-Gain monitor	0.0 to 100.0
db-62	Current PID I-Gain monitor	0.0 to 3600.0 (sec)
db-63	Current PID D-Gain monitor	0.00 to 100.00 (sec)
db-64	PID feedforward monitor	0.00 to 100.00 (%)
dC-01	Inverter load type status	00(Very low duty)/ 01(Low duty)/ 02(Normal duty)
dC-02	Rated current monitor	0.0 to 6553.5 (A)
dC-07	Main speed input source monitor	00(Disabled)/ 01(Terminal[Ai1])/ 02(Terminal[Ai2])/ 03(Terminal[Ai3])/ 04(Terminal[Ai4])/ 05(Terminal[Ai5])/ 06(Terminal[Ai6])/ 07(Multi-Speed 0)/ 08(Auxiliary speed)/ 09(Multi-Speed 1)/ 10(Multi-Speed 2)/ 11(Multi-Speed 3)/ 12(Multi-Speed 4)/ 13(Multi-Speed 5)/ 14(Multi-Speed 6)/ 15(Multi-Speed 7)/ 16(Multi-Speed 8)/ 17(Multi-Speed 9)/ 18(Multi-Speed 10)/ 19(Multi-Speed 11)/ 20(Multi-Speed 12)/ 21(Multi-Speed 13)/ 22(Multi-Speed 14)/ 23(Multi-Speed 15)/ 24(JG[AG-20])/ 25(RS485)/ 26(Option-1)/ 27(Option-2)/ 28(Option-3)/ 29(Pls-Train(In))/ 30(Pls-Train(Out))/ 31(EzSQ)/ 32(PID)/ 33(Volume of MOP-VR)/ 34(AHD retention speed)
dC-08	Sub speed input source monitor	00(Disabled)/ 01(Terminal[Ai1])/ 02(Terminal[Ai2])/ 03(Terminal[Ai3])/ 04(Terminal[Ai4])/ 05(Terminal[Ai5])/ 06(Terminal[Ai6])/ 08(Auxiliary speed)/ 25(RS485)/ 26(Option-1)/ 27(Option-2)/ 28(Option-3)/ 29(Pls-Train(In))/ 30(Pls-Train(Out))/ 31(EzSQ)/ 32(PID)/ 33(MOP-VR)
dC-10	RUN command input source monitor	00([FW]/[RV] terminal)/ 01(3-wire)/ 02(Keypad's RUN key)/ 03(RS485)/ 04(Option-1)/ 05(Option-2)/ 06(Option-3)
dC-15	Cooling fin temperature monitor	-20.0 to 200.0 (°C)
dC-16	Life assessment monitor	LL to HH [L:Normal/H:Worn out] [Left](FAN lifespan) [Right](board capacitor lifespan)
dC-20	Accumulated number of starts monitor	1 to 65535
dC-21	Accumulated number of power-on times monitor	
dC-22	Accumulated RUN time monitor	
dC-24	Accumulated power-on time monitor	0 to 1000000 (hr)
dC-26	Accumulated cooling-fan run time monitor	
dC-37	Icon 2 LIM monitor	00(Other than below)/ 01(OC suppress)/ 02(OL restriction)/ 03(OV suppress)/ 04(TRQ Limit)/ 05(Freq Limit)/ 06(Min.Freq)
dC-38	Icon 2 ALT monitor	00(Other than below)/ 01(OL notice)/ 02(Motor thermal notice)/ 03(Controller thermal notice)/ 04(Motor overheating notice)
dC-39	Icon 2 RETRY detail monitor	00(Other than below)/ 01(Waiting for retry)/ 02(Waiting for restart)
dC-40	Icon 2 NRDY detail monitor	00(Other than below)/ 01(Trip occurrence)/ 02(Power supply error)/ 03(Resetting)/ 04(STO)/ 05(Standby)/ 06(Data Warning, etc)/ 07(EzSQ Sequence error)/ 08(Free run)/ 09(Forced stop)
dC-45	IM/SM monitor	00(IM selected)/ 01(SM selected)
dC-50	Firmware ver. monitor	00.00 to 99.99
dC-53	Firmware Gr. Monitor	00(Standard)
dE-50	Warning monitor	0 to 65535

Variable mode monitor (F code)

Code No.	Parameter Meaning	Selectable User Setting
FA-01	Main speed reference setting or monitor	(Unsigned) 0.00 to 590.00 (Hz)
FA-02	Sub-speed reference setting or monitor	-590.00 to 590.00 (Hz) (Monitor) 0.00 to 590.00 (Hz) (Setting)
FA-10	Acceleration time setting or monitor	0.00 to 3600.00 (sec)
FA-12	Deceleration time setting or monitor	
FA-15	Torque reference setting or monitor	
FA-16	Torque bias setting or monitor	-500.0 to +500.0 (%)
FA-20	Position reference setting or monitor	-268435455 to +268435455 (pls) [Normal] -1073741823 to +1073741823 (pls) [H-Reso]
FA-30	PID1 set-point 1 setting or monitor	
FA-32	PID1 set-point 2 setting or monitor	-100.00 to 100.00 (%)
FA-34	PID1 set-point 3 setting or monitor	(Range will depend on the parameters [AH-04], [AH-05], [AH-06])
FA-36	PID2 set-point setting or monitor	-100.00 to 100.00 (%) (Range will depend on the parameters [AJ-04], [AJ-05], [AJ-06])
FA-38	PID3 set-point setting or monitor	-100.00 to 100.00 (%) (Range will depend on the parameters [AJ-24], [AJ-25], [AJ-26])
FA-40	PID4 set-point setting or monitor	-100.00 to 100.00 (%) (Range will depend on the parameters [AJ-44], [AJ-45], [AJ-46])

● Parameter mode List

■ Structure of parameter code

- A parameter consists of a parameter group, switch recognition number assigned by the 024[SET] terminal function, and an in-group number.
- If the switch recognition number assigned by 024[SET] terminal function is “-”, it is enabled in both 1st motor and 2nd motor.
- If the 024[SET] function is not set to the input terminal functions [CA-01] to [CA-11], 1st motor is valid.

AA 1 01

- In-group number
- -: Common for 1st and 2nd motor
1: 1st motor enabled if function [SET] is OFF
2: 2nd motor enabled if function [SET] is ON
- Parameter group

■ Parameter mode (A code)

Code No.	Parameter Meaning	Selectable User Setting	Initial value
AA101	Main speed input source selection, 1st-motor	01(Terminal[Ai1])/ 02(Terminal[Ai2])/ 03(Terminal[Ai3])/ 04(Terminal[Ai4])/ 05(Terminal[Ai5])/ 06(Terminal[Ai6])/ 07(Parameter Setting)/ 08(RS485)/ 09(Option-1)/ 10(Option-2)/ 11(Option-3)/ 12(Pulse train input(Internal))/ 13(Pulse train input(Option))/ 14(Program function)/ 15(PID calc.)/ 16(Volume of MOP-VR)	07(*FF)/ 01(*FEF,FUF)
AA102	Sub speed input source selection, 1st-motor	00(Disable)/ 01(Terminal[Ai1])/ 02(Terminal[Ai2])/ 03(Terminal[Ai3])/ 04(Terminal[Ai4])/ 05(Terminal[Ai5])/ 06(Terminal[Ai6])/ 07(Parameter Setting)/ 08(RS485)/ 09(Option-1)/ 10(Option-2)/ 11(Option-3)/ 12(Pulse train input(Internal))/ 13(Pulse train input(Option))/ 14(Program function)/ 15(PID calc.)/ 16(Volume of MOP-VR)	00
AA104	Sub speed setting, 1st-motor	0.00 to 590.00 (Hz)	0.00
AA105	Speed reference calculation symbol selection, 1st-motor	00(Disable)/ 01(Addition)/ 02(Subtraction)/ 03(Multiplication)	00
AA106	Add frequency setting, 1st-motor	-590.00 to 590.00 (Hz)	0.00
AA111	RUN command input source selection, 1st-motor	00([FW]/[RV] terminal)/ 01(3-wire)/ 02(Keypad's RUN-key)/ 03(RS485)/ 04(Option-1)/ 05(Option-2)/ 06(Option-3)	02(*FF)/ 00(*FEF,FUF)
AA-12	RUN-key command rotation direction	00(Forward)/ 01(Reverse)	00
AA-13	STOP-key enable	00(Disable)/ 01(Enable)/ 02(Enable at only trip reset)	01
AA114	RUN direction restriction, 1st-motor	00(No restriction)/ 01(Only forward)/ 02(Only reverse)	00
AA115	STOP mode selection, 1st-motor	00(Deceleration stop)/ 01(Free-run stop)	00
AA121	Control mode selection, 1st-motor	00([V/f] Fixed torque characteristics (IM))/ 01([V/f] Reducing torque characteristics (IM))/ 02([V/f] Free V/f (IM))/ 03([V/f] Auto torque boost (IM))/ 04([V/f with encoder] Fixed torque characteristics (IM))/ 05([V/f with encoder] Reduced torque characteristics (IM))/ 06([V/f with encoder] Free V/f (IM))/ 07([V/f with encoder] Auto torque boost (IM))/ 08(Sensorless vector control (IM))/ 09(Zero-Hz-range sensorless vector control (IM))/ 10(Vector control with encoder (IM))/ 11(Synchronous start type sensorless vector control (SM/PMM))/ 12(VMS start type sensorless vector control (SM/PMM))	00
AA123	Vector control mode selection, 1st-motor	00(Speed/Torque control mode)/ 01(Pulse train position control)/ 02(Absolute position control)/ 03(High resolution absolute position control)	00
AA201	Main speed input source selection, 2nd-motor	00(Disable)/ 01(Terminal[Ai1])/ 02(Terminal[Ai2])/ 03(Terminal[Ai3])/ 04(Terminal[Ai4])/ 05(Terminal[Ai5])/ 06(Terminal[Ai6])/ 07(Parameter Setting)/ 08(RS485)/ 09(Option-1)/ 10(Option-2)/ 11(Option-3)/ 12(Pulse train input(Internal))/ 13(Pulse train input(Option))/ 14(Program function)/ 15(PID calc.)/ 16(Volume of MOP-VR)	07(*FF)/ 01(*FEF,FUF)
AA202	Sub speed input source selection, 2nd-motor	00(Disable)/ 01(Terminal[Ai1])/ 02(Terminal[Ai2])/ 03(Terminal[Ai3])/ 04(Terminal[Ai4])/ 05(Terminal[Ai5])/ 06(Terminal[Ai6])/ 07(Parameter Setting)/ 08(RS485)/ 09(Option-1)/ 10(Option-2)/ 11(Option-3)/ 12(Pulse train input(Internal))/ 13(Pulse train input(Option))/ 14(Program function)/ 15(PID calc.)/ 16(Volume of MOP-VR)	00
AA204	Sub speed setting, 2nd-motor	0 to 590.00 (Hz)	0.00
AA205	Speed reference calculation symbol selection, 2nd-motor	00(Disable)/ 01(Addition)/ 02(Subtraction)/ 03(Multiplication)	00
AA206	Add frequency setting, 2nd-motor	-590.00 to 590.00 (Hz)	0.00
AA211	RUN command input source selection, 2nd-motor	00([FW]/[RV] terminal)/ 01(3-wire)/ 02(Keypad's RUN-key)/ 03(RS485)/ 04(Option-1)/ 05(Option-2)/ 06(Option-3)	02(*FF)/ 00(*FEF,FUF)
AA214	RUN-direction restriction selection, 2nd-motor	00(No restriction)/ 01(Enable only Forward rotation)/ 02(Enable only Reverse rotation)	00

Code No.	Parameter Meaning	Selectable User Setting	Initial value
AA215	STOP mode selection, 2nd-motor	00(Deceleration until stop)/ 01(Free-run stop)	00
AA221	Control mode selection, 2nd-motor	00([V/f] Fixed torque characteristics (IM))/ 01([V/f] Reducing torque characteristics (IM))/ 02([V/f] Free V/f (IM))/ 03([V/f] Auto torque boost (IM))/ 04([V/f with encoder] Fixed torque characteristics (IM))/ 05([V/f with encoder] Reduced torque characteristics (IM))/ 06([V/f with encoder] Free V/f (IM))/ 07([V/f with encoder] Auto torque boost (IM))/ 08(Sensorless vector control (IM))/ 09(Zero-Hz-range sensorless vector control (IM))/ 10(Vector control with encoder (IM))/ 11(Synchronous start type sensorless vector control (SM/PMM))	00
AA223	Vector control mode selection, 2nd-motor	00(Speed/Torque control mode)/ 01(Pulse train position control)/ 02(Absolute position control)/ 03(High resolution absolute position control)	00
Ab-01	Frequency conversion gain	0.01 to 100.00	1.00
Ab-03	Multi-speed operation selection	00(Binary(16 speeds))/ 01(Bit(8 speeds))	00
Ab110	Multi-speed 0 setting, 1st-motor		
Ab-11 to Ab-25	Multi-speed 1 to Multi-speed 15 setting	0.00 to 590.00(Hz)	0.00
Ab210	Multi-speed 0 setting, 2nd-motor		
AC-01	Acceleration/Deceleration time input source selection	00(Parameter setting)/ 01(Option-1)/ 02(Option-2)/ 03(Option-3)/ 04(Function EzSQ)	00
AC-02	Acceleration/Deceleration selection	00(Common setting)/ 01(Multi stage accel/ decel)	00
AC-03	Acceleration curve selection	00(Linear)/ 01(S-curve)/ 02(U-curve)/ 03(Reverse U-curve)/ 04(Elevator S-curve)	00
AC-04	Deceleration curve selection		
AC-05	Acceleration curve constant setting	1 to 10	2
AC-06	Deceleration curve constant setting		
AC-08	EL-S-curve ratio @start of acceleration		
AC-09	EL-S-curve ratio @end of acceleration	0 to 100 (%)	25
AC-10	EL-S-curve ratio @start of deceleration		
AC-11	EL-S-curve ratio @end of deceleration		
AC115	Accel/Decel change trigger, 1st-motor	00(Switching by [2CH] terminal)/ 01(Switching by setting)/ 02(Switching only when rotation is reversed)	00
AC116	Accel1 to Accel2 frequency transition point, 1st-motor	0.00 to 590.00 (Hz)	0.00
AC117	Decel1 to Decel2 frequency transition point, 1st-motor		
AC120	Acceleration time setting 1, 1st-motor		30.00
AC122	Deceleration time setting 1, 1st-motor		
AC124	Acceleration time setting 2, 1st-motor	0.00 to 3600.00 (sec)	
AC126	Deceleration time setting 2, 1st-motor		15.00
AC-30, 34, 38, 42, 46, 50, 54, 58, 62, 66, 70, 74, 78, 82, 86	Accel. time for Multi-speed 1 to Multi-speed 15		0.00
AC-32, 36, 40, 44, 48, 52, 56, 60, 64, 68, 72, 76, 80, 84, 88	Decel. time for Multi-speed 1 to Multi-speed 15		
AC215	Accel/Decel change trigger, 2nd-motor	00(Switching by [2CH] terminal)/ 01(Switching by setting)/ 02(Switching only when rotation is reversed)	00
AC216	Accel1 to Accel2 frequency transition point, 2nd-motor	0.00 to 590.00 (Hz)	0.00
AC217	Decel1 to Decel2 frequency transition point, 2nd-motor		
AC220	Acceleration time 1, 2nd-motor		30.00
AC222	Deceleration time 1, 2nd-motor		
AC224	Acceleration time 2, 2nd-motor	0.00 to 3600.00 (sec)	
AC226	Deceleration time 2, 2nd-motor		15.00
Ad-01	Torque reference input source selection	01(Terminal[Ai1])/ 02(Terminal[Ai2])/ 03(Terminal[Ai3])/ 04(Terminal[Ai4])/ 05(Terminal[Ai5])/ 06(Terminal[Ai6])/ 07(Parameter Setting)/ 08(RS485)/ 09(Option-1)/ 10(Option-2)/ 11(Option-3)/ 12(Pulse train input(Internal))/ 13(Pulse train input(Option))/ 15(PID calc.)	07

Code No.	Parameter Meaning	Selectable User Setting	Initial value
Ad-02	Torque reference value setting	-500.0 to +500.0 (%)	0.0
Ad-03	Polarity selection for torque reference	00(According to sign)/ 01(Depending on the operation direction)	00
Ad-04	Switching time of speed control to torque control	0 to 1000 (ms)	100
Ad-11	Torque bias input source selection	00(Disable)/ 01(Terminal[Ai1])/ 02(Terminal[Ai2])/ 03(Terminal[Ai3])/ 04(Terminal[Ai4])/ 05(Terminal[Ai5])/ 06(Terminal[Ai6])/ 07(Parameter Setting)/ 08(RS485)/ 09(Option-1)/ 10(Option-2)/ 11(Option-3)/ 12(Pulse train input(Internal))/ 13(Pulse train input(Option))/ 15(PID calc.)	00
Ad-12	Torque bias value setting	-500.0 to +500.0 (%)	0.0
Ad-13	Torque bias polarity	00(According to sign)/ 01(Depending on the operation direction)	00
Ad-14	Enable terminal [TBS]	00(Disable)/ 01(Enable)	00
Ad-40	Speed limit input source selection at torque control	01(Terminal[Ai1])/ 02(Terminal[Ai2])/ 03(Terminal[Ai3])/ 04(Terminal[Ai4])/ 05(Terminal[Ai5])/ 06(Terminal[Ai6])/ 07(Parameter Setting)/ 08(RS485)/ 09(Option-1)/ 10(Option-2)/ 11(Option-3)/ 12(Pulse train input(Internal))/ 13(Pulse train input(Option))	07
Ad-41	Speed limit at torque control (at Forward rotation)	0.00 to 590.00 (Hz)	0.00
Ad-42	Speed limit at torque control (at Reverse rotation)		
AE-01	Electronic gear setting point selection	00(Feedback side)/ 01(Reference side)	00
AE-02	Electronic gear ratio numerator	1 to 10000	1
AE-03	Electronic gear ratio denominator	1 to 10000	1
AE-04	Positioning completed range setting	0 to 10000 (pls)	5
AE-05	Positioning completed delay time setting	0.00 to 10.00 (sec)	0.00
AE-06	Position feedforward gain setting	0.00 to 655.35	0.00
AE-07	Position loop gain setting	0.00 to 100.00	0.50
AE-08	Position bias setting	-2048 to 2048 (pls)	0
AE-10	Stop position selection of home search function	00(Setting by parameter)/ 01(Option-1)/ 02(Option-2)/ 03(Option-3)	00
AE-11	Stop position of home search function	0 to 4095	0
AE-12	Speed reference of home search function	0.00 to 120.00 (Hz)	0.00
AE-13	Direction of home search function	00(Forward)/ 01(Reverse)	00
AE-20 to AE-50	Position reference 0 to 15	-268435455 to +268435455 (pls) [Normal] -1073741823 to +1073741823 (pls) [H-Reso]	0
AE-52	Position control range setting (forward)	0 to +268435455 (pls) [Normal] 0 to +1073741823 (pls) [H-Reso]	[Normal] 268435455 [H-Reso] 1073741823
AE-54	Position control range setting (reverse)	-268435455 to 0 (pls) [Normal] -1073741823 to 0 (pls) [H-Reso]	[Normal] -268435455 [H-Reso] -1073741823
AE-56	Position control mode selection	00(Limited)/ 01(Not limited)	00
AE-60	Teach-in function target selection	00 to 15 (X00 to X15)	00
AE-61	Save current position at power off	00(Disable)/ 01(Enable)	00
AE-62	Pre-set position data	-268435455 to +268435455 (pls) [Normal] -1073741823 to +1073741823 (pls) [H-Reso]	0
AE-64	Deceleration stop distance calculation gain	50.00 to 200.00 (%)	100.00
AE-65	Deceleration stop distance calculation bias	0.00 to 655.35 (%)	0.00
AE-66	Speed limit in APR control	0.00 to 100.00 (%)	1.00
AE-67	APR start speed	0.00 to 100.00 (%)	0.20
AE-70	Homing function selection	00(Low-speed)/ 01(High-Speed 1)/ 02(High-Speed 2)	00
AE-71	Direction of homing function	00(Forward)/ 01(Reverse)	00
AE-72	Low-speed homing speed setting	0.00 to 10.00 (Hz)	0.00
AE-73	High-speed homing speed setting	0.00 to 590.00 (Hz)	
AF101	DC braking selection, 1st-motor	00(Disable)/ 01(Enable)/ 02(Frequency reference)	00
AF102	Braking type selection, 1st-motor	00(DC braking)/ 01(Speed servo-lock)/ 02(Position servo-lock)	00
AF103	DC braking frequency, 1st-motor	0.00 to 590.00 (Hz)	0.50
AF104	DC braking delay time, 1st-motor	0.00 to 5.00 (sec)	0.00
AF105	DC braking force setting, 1st-motor	0 to 100 (%) (Might be internally limited)	30
AF106	DC braking active time at stop, 1st-motor	0.00 to 60.00 (sec)	0.00
AF107	DC braking operation method selection, 1st-motor	00(Edge)/ 01(Level)	01
AF108	DC braking force at start, 1st-motor	0 to 100 (%) (Might be internally limited)	30

Code No.	Parameter Meaning	Selectable User Setting	Initial value
AF109	DC braking active time at start, 1st-motor	0.00 to 60.00 (sec)	0.00
AF120	Contactor control enable, 1st-motor	00(Disable)/ 01(Enable: primary side)/ 02(Enable: secondary side)	00
AF121	Run delay time, 1st-motor	0.00 to 2.00 (sec)	0.20
AF122	Contactor off delay time, 1st-motor		0.10
AF123	Contactor response check time, 1st-motor	0.00 to 5.00 (sec)	0.10
AF130	Brake control enable, 1st-motor	00(Disable)/ 01(Brake control 1: Common)/ 02(Brake control 1: Separate)/ 03(Brake control 2)	00
AF131	Brake release wait time, 1st-motor (Forward)	0.00 to 5.00 (sec)	0.00
AF132	Brake wait time for accel., 1st-motor (Forward)		
AF133	Brake wait time for stopping, 1st-motor (Forward)		
AF134	Brake confirmation signal wait time, 1st-motor (Forward)		
AF135	Brake release frequency setting, 1st-motor (Forward)	0.00 to 590.00 (Hz)	0.00
AF136	Brake release current setting, 1st-motor (Forward)	(0.00 to 2.00)* Inverter rated current (A)	1.00 *Inverter rated current
AF137	Braking frequency, 1st-motor (Forward)	0.00 to 590.00 (Hz)	0.00
AF138	Brake release wait time, 1st-motor (Reverse)	0.00 to 5.00 (sec)	0.00
AF139	Brake wait time for accel., 1st-motor (Reverse)		
AF140	Brake wait time for stopping, 1st-motor (Reverse)		
AF141	Brake confirmation signal wait time, 1st-motor (Reverse)		
AF142	Brake release frequency setting, 1st-motor (Reverse)	0.00 to 590.00 (Hz)	0.00
AF143	Brake release current setting, 1st-motor (Reverse)	(0.00 to 2.00)* Inverter rated current (A)	1.00 *Inverter rated current
AF144	Braking frequency, 1st-motor (Reverse)	0.00 to 590.00 (Hz)	0.00
AF150	Brake open delay time, 1st-motor	0.00 to 2.00 (sec)	0.20
AF151	Brake close delay time, 1st-motor		
AF152	Brake response check time, 1st-motor	0.00 to 5.00 (sec)	0.10
AF153	Servo lock/ DC injection time at start, 1st-motor	0.00 to 10.00 (sec)	0.60
AF154	Servo lock/ DC injection time at stop, 1st-motor		
AF201	DC braking selection, 2nd-motor	00(Disable)/ 01(Enable)/ 02(Frequency reference)	00
AF202	Braking type selection, 2nd-motor	00(DC braking)/ 01(Speed servo lock)/ 02(Position servo lock)	00
AF203	DC braking frequency, 2nd-motor	0.00 to 590.00 (Hz)	0.50
AF204	DC braking delay time, 2nd-motor	0.00 to 5.00 (sec)	0.00
AF205	DC braking force setting, 2nd-motor	0 to 100 (%)	30
AF206	DC braking active time at stop, 2nd-motor	0.00 to 60.00 (sec)	0.00
AF207	DC braking operation method selection, 2nd-motor	00(Edge)/ 01(Level)	01
AF208	DC braking force at start, 2nd-motor	0 to 100 (%)	30
AF209	DC braking active time at start, 2nd-motor	0.00 to 60.00 (sec)	0.00
AF220	Contactor control enable, 2nd-motor	00(Disable)/ 01(Enable: primary side)/ 02(Enable: secondary side)	00
AF221	Run delay time, 2nd-motor	0.00 to 2.00 (sec)	0.20
AF222	Contactor off delay time, 2nd-motor		0.10
AF223	Contactor response check time, 2nd-motor	0.00 to 5.00 (sec)	0.10
AF230	Brake control enable, 2nd-motor	00(Disable)/ 01(Brake control 1: Common)/ 02(Brake control 1: Separate)/ 03(Brake control 2)	00
AF231	Brake release wait time, 2nd-motor (Forward)	0.00 to 5.00 (sec)	0.00
AF232	Brake wait time for accel., 2nd-motor (Forward)		
AF233	Brake wait time for stopping, 2nd-motor (Forward)		
AF234	Brake confirmation signal wait time, 2nd-motor (Forward)		
AF235	Brake release frequency setting, 2nd-motor (Forward)	0.00 to 590.00 (Hz)	0.00

Code No.	Parameter Meaning	Selectable User Setting	Initial value	
AF236	Brake release current setting, 2nd-motor (Forward)	(0.00 to 2.00)* Inverter rated current (A)	1.00 *Inverter rated current	
AF237	Braking frequency, 2nd-motor (Forward)	0.00 to 590.00 (Hz)	0.00	
AF238	Brake release wait time, 2nd-motor (Reverse)	0.00 to 5.00 (sec)	0.00	
AF239	Brake wait time for accel., 2nd-motor (Reverse)			
AF240	Brake wait time for stopping, 2nd-motor (Reverse)			
AF241	Brake confirmation signal wait time, 2nd-motor (Reverse)	0.00 to 590.00 (Hz)	0.00	
AF242	Brake release frequency setting, 2nd-motor (Reverse)			
AF243	Brake release current setting, 2nd-motor (Reverse)	(0.00 to 2.00)* Inverter rated current (A)	1.00 *Inverter rated current	
AF244	Braking frequency, 2nd-motor (Reverse side)	0.00 to 590.00 (Hz)	0.00	
AF250	Brake open delay time, 2nd-motor	0.00 to 2.00 (sec)	0.20	
AF251	Brake close delay time, 2nd-motor			
AF252	Brake response check time, 2nd-motor	0.00 to 5.00 (sec)	0.10	
AF253	Servo lock/DC injection time at start, 2nd-motor	0.00 to 10.00 (sec)	0.60	
AF254	Servo lock/DC injection time at stop, 2nd-motor			
AG101	Jump frequency 1, 1st-motor	0.00 to 590.00 (Hz)	0.00	
AG102	Jump frequency width 1, 1st-motor	0.00 to 10.00 (Hz)		
AG103	Jump frequency 2, 1st-motor	0.00 to 590.00 (Hz)		
AG104	Jump frequency width 2, 1st-motor	0.00 to 10.00 (Hz)		
AG105	Jump frequency 3, 1st-motor	0.00 to 590.00 (Hz)		
AG106	Jump frequency width 3, 1st-motor	0.00 to 10.00 (Hz)		
AG110	Acceleration stop frequency setting, 1st-motor	0.00 to 590.00 (Hz)		
AG111	Acceleration stop time setting, 1st-motor	0.0 to 60.0 (sec)		0.0
AG112	Deceleration stop frequency setting, 1st-motor	0.00 to 590.00 (Hz)		0.00
AG113	Deceleration stop time setting, 1st-motor	0.0 to 60.0 (sec)		0.0
AG-20	Jogging frequency	0.00 to 10.00 (Hz)	6.00	
AG-21	Jogging stop mode selection	00(Free run at Jogging stop (Disable at run))/ 01(Deceleration stop at Jogging stop (Disable at run))/ 02(DC braking at Jogging stop (Disable at run))/ 03(Free run at Jogging stop (Enable at run))/ 04(Deceleration stop at Jogging stop (Enable at run))/ 05(DC braking at Jogging stop (Enable at run))	00	
AG201	Jump frequency 1, 2nd-motor	0.00 to 590.00 (Hz)	0.00	
AG202	Jump frequency width 1, 2nd-motor	0.00 to 10.00 (Hz)		
AG203	Jump frequency 2, 2nd-motor	0.00 to 590.00 (Hz)		
AG204	Jump frequency width 2, 2nd-motor	0.00 to 10.00 (Hz)		
AG205	Jump frequency 3, 2nd-motor	0.00 to 590.00 (Hz)		
AG206	Jump frequency width 3, 2nd-motor	0.00 to 10.00 (Hz)		
AG210	Acceleration stop frequency setting, 2nd-motor	0.00 to 590.00 (Hz)		
AG211	Acceleration stop time setting 2nd-motor	0.0 to 60.0 (sec)		0.0
AG212	Deceleration stop frequency setting, 2nd-motor	0.00 to 590.00 (Hz)		0.00
AG213	Deceleration stop time setting, 2nd-motor	0.0 to 60.0 (sec)		0.0
AH-01	PID1 enable	00(Disable)/ 01(Enable)/ 02(Enable (with inverted output))	00	
AH-02	PID1 deviation inversion	00(Disable)/ 01(Enable)	00	
AH-03	Unit selection for PID1	00(non)/ 01(%) 02(A) 03(Hz)/ 04(V)/ 05(kW)/ 06(W)/ 07(hr)/ 08(s)/ 09(kHz)/ 10(ohm)/ 11(mA)/ 12(ms)/ 13(P)/ 14(kgm ²)/ 15(psi)/ 16(m/h)/ 17(Vdc)/ 18(°C)/ 19(kWh)/ 20(mF)/ 21(mVs/rad)/ 22(Nm)/ 23(min ⁻¹)/ 24(m/s)/ 25(m/min)/ 26(m/h)/ 27(ft/s)/ 28(ft/min)/ 29(ft/h)/ 30(m)/ 31(cm)/ 32(°F)/ 33(l/s)/ 34(l/min)/ 35(l/h)/ 36(m ³ /s)/ 37(m ³ /min)/ 38(m ³ /h)/ 39(kg/s)/ 40(kg/min)/ 41(kg/h)/ 42(t/min)/ 43(t/h)/ 44(gal/s)/ 45(gal/min)/ 46(gal/h)/ 47(t ³ /s)/ 48(t ³ /min)/ 49(t ³ /h)/ 50(lb/s)/ 51(lb/min)/ 52(lb/h)/ 53(mbar)/ 54(bar)/ 55(Pa)/ 56(kPa)/ 57(PSI)/ 58(mm)	01	
AH-04	PID1 adjustment (0%)	-10000 to 10000	0	
AH-05	PID1 adjustment (100%)		10000	
AH-06	PID1 adjustment (decimal point position)	0 to 4	2	

Code No.	Parameter Meaning	Selectable User Setting	Initial value
AH-07	PID1 set-point 1 input source selection	00(Not used)/ 01(Terminal[Ai1])/ 02(Terminal[Ai2])/ 03(Terminal[Ai3])/ 04(Terminal[Ai4])/ 05(Terminal[Ai5])/ 06(Terminal[Ai6])/ 07(Parameter setting)/ 08(RS485)/ 09(Option-1)/ 10(Option-2)/ 11(Option-3)/ 12(Pulse train input(Internal))/ 13(Pulse train input(Option))	07
AH-10	PID1 set-point-1 setting	-100.00 to 100.00 (%)	0.00
AH-12 to AH-40	PID1 multistage set-point 1 to 15	(Range will depend on the parameters [AH-04], [AH-05], [AH-06])	
AH-42	PID1 set-point 2 input source selection	00(Not used)/ 01(Terminal[Ai1])/ 02(Terminal[Ai2])/ 03(Terminal[Ai3])/ 04(Terminal[Ai4])/ 05(Terminal[Ai5])/ 06(Terminal[Ai6])/ 07(Parameter setting)/ 08(RS485)/ 09(Option-1)/ 10(Option-2)/ 11(Option-3)/ 12(Pulse train input(Internal))/ 13(Pulse train input(Option))	00
AH-44	PID1 set-point 2 setting	Range will depend on the parameters [AH-04], [AH-05], [AH-06] -100.00 to 100.00 (%)	0.00
AH-46	PID1 set-point 3 input source selection	00(Not used)/ 01(Terminal[Ai1])/ 02(Terminal[Ai2])/ 03(Terminal[Ai3])/ 04(Terminal[Ai4])/ 05(Terminal[Ai5])/ 06(Terminal[Ai6])/ 07(Parameter setting)/ 08(RS485)/ 09(Option-1)/ 10(Option-2)/ 11(Option-3)/ 12(Pulse train input(Internal))/ 13(Pulse train input(Option))	00
AH-48	PID1 set-point 3 setting	Range will depend on the parameters [AH-04], [AH-05], [AH-06] -100.00 to 100.00 (%)	0.00
AH-50	PID1 set-point calculation symbol selection	01(Addition)/ 02(Subtraction)/ 03(Multiplication)/ 04(Division)/ 05(Minimum deviation)/ 06(Maximum deviation)	01
AH-51	PID1 feedback 1 input source selection	00(Not used)/ 01(Terminal[Ai1])/ 02(Terminal[Ai2])/ 03(Terminal[Ai3])/ 04(Terminal[Ai4])/ 05(Terminal[Ai5])/ 06(Terminal[Ai6])/ 08(RS485)/ 09(Option-1)/ 10(Option-2)/ 11(Option-3)/ 12(Pulse train input(Internal))/ 13(Pulse train input(Option))	01
AH-52	PID1 feedback 2 input source selection		00
AH-53	PID1 feedback 3 input source selection		00
AH-54	PID1 feedback calculation symbol selection	01(Addition)/ 02(Subtraction)/ 03(Multiplication)/ 04(Division)/ 05(Square Root of FB1)/ 06(Square Root of FB2)/ 07(Square Root FB1-FB2)/ 08(Average of the three inputs)/ 09(Minimum of the three inputs)/ 10(Maximum of the three inputs)	01
AH-60	PID1 gain change method selection	00(Using gain-1 only)/ 01(PRO terminal)	00
AH-61	PID1 proportional gain 1	0.0 to 100.0	1.0
AH-62	PID1 integral time constant 1	0.0 to 3600.0 (sec)	1.0
AH-63	PID1 derivative gain 1	0.00 to 100.00 (sec)	0.00
AH-64	PID1 proportional gain 2	0.0 to 100.0	0.0
AH-65	PID1 integral time constant 2	0.0 to 3600.0 (sec)	0.0
AH-66	PID1 derivative gain 2	0.00 to 100.00 (sec)	0.00
AH-67	PID1 gain change time	0 to 10000 (ms)	100
AH-70	PID1 feed-forward input source selection	00(Not used)/ 01(Terminal[Ai1])/ 02(Terminal[Ai2])/ 03(Terminal[Ai3])/ 04(Terminal[Ai4])/ 05(Terminal[Ai5])/ 06(Terminal[Ai6])	00
AH-71	PID1 output range		0.00
AH-72	PID1 over deviation level	0.00 to 100.00 (%)	3.00
AH-73	Turn-off level for the PID1 feedback compare signal		100.00
AH-74	Turn-on level for the PID1 feedback compare signal	0.00 to 100.00 (%)	0.00
AH-75	PID soft start function enable	00(Disable)/ 01(Enable)	00
AH-76	PID soft start target level	0.00 to 100.00 (%)	100.00
AH-78	Acceleration time setting for PID soft start function	0.00 to 3600.00 (sec)	30.00
AH-80	PID soft start time	0.00 to 600.00 (sec) *1)	0.00
AH-81	PID soft start error detection enable	00(Disable)/ 01(Enable: Error)/ 02(Enable: Warning)	00
AH-82	PID soft start error detection level	0.00 to 100.00 (%)	0.00
AH-85	PID sleep trigger selection	00(Disable)/ 01(Low output)/ 02([SLEP] terminal)	00
AH-86	PID sleep start level	0.00 to 590.00 (Hz)	0.00
AH-87	PID sleep active time	0.00 to 100.00 (sec)	0.00
AH-88	Enable set-point boost before PID sleep	00(Disable)/ 01(Enable)	00
AH-89	Set-point boost time before PID sleep	0.00 to 100.00 (sec)	0.00
AH-90	Set-point boost value before PID sleep	0.00 to 100.00 (%)	0.00
AH-91	Minimum RUN time before PID sleep	0.00 to 100.00 (sec)	0.00
AH-92	Minimum active time of PID sleep		
AH-93	PID wake trigger selection	01(Deviation)/ 02(Low feedback)/ 03([WAKE] terminal)	01
AH-94	PID wake start level	0.00 to 100.00 (%)	0.00
AH-95	PID wake start time	0.00 to 100.00 (sec)	
AH-96	PID wake start deviation value	0.00 to 100.00 (%)	
AJ-01	PID2 enable	00(Disable)/ 01(Enable)/ 02(Enable (with inverted output))	00
AJ-02	PID2 deviation inversion	00(Disable)/ 01(Enable)	00
AJ-03	PID2 unit selection	Same as [AH-03]	01
AJ-04	PID2 scale adjustment (0%)	-10000 to 10000	0
AJ-05	PID2 scale adjustment (100%)		10000
AJ-06	PID2 scale adjustment (decimal point position)	0 to 4	2

*1) For version prior to Ver.2.02 the maximum range is 100.00.

Code No.	Parameter Meaning	Selectable User Setting	Initial value
AJ-07	PID2 set-point input source selection	00(Not used)/ 01(Terminal[Ai1])/ 02(Terminal[Ai2])/ 03(Terminal[Ai3])/ 04(Terminal[Ai4])/ 05(Terminal[Ai5])/ 06(Terminal[Ai6])/ 07(Parameter setting)/ 08(RS485)/ 09(Option-1)/ 10(Option-2)/ 11(Option-3)/ 12(Pulse train input(Internal))/ 13(Pulse train input(Option))	07
AJ-10	PID2 set-point setting	Range will depend on the parameters [AJ-04], [AJ-05], [AJ-06] -100.00 to 100.00 (%)	0.00
AJ-12	PID2 feedback input source selection	00(Not used)/ 01(Terminal[Ai1])/ 02(Terminal[Ai2])/ 03(Terminal[Ai3])/ 04(Terminal[Ai4])/ 05(Terminal[Ai5])/ 06(Terminal[Ai6])/ 08(RS485)/ 09(Option-1)/ 10(Option-2)/ 11(Option-3)/ 12(Pulse train input(Internal))/ 13(Pulse train input(Option))	02
AJ-13	PID2 proportional gain	0.0 to 100.0	1.0
AJ-14	PID2 integral time constant	0.0 to 3600.0 (sec)	1.0
AJ-15	PID2 derivative gain	0.00 to 100.00 (sec)	0.00
AJ-16	PID2 output range		0.00
AJ-17	PID2 over deviation level		3.00
AJ-18	Turn-off level for the PID2 feedback compare signal	0.00 to 100.00 (%)	100.00
AJ-19	Turn-on level for the PID2 feedback compare signal		0.00
AJ-21	PID3 enable	00(Disable)/ 01(Enable)/ 02(Enable (with inverted output))	00
AJ-22	PID3 deviation inversion	00(Disable)/ 01(Enable)	00
AJ-23	PID3 unit selection	Same as [AH-03]	01
AJ-24	PID3 scale adjustment (0%)	-10000 to 10000	0
AJ-25	PID3 scale adjustment (100%)	-10000 to 10000	10000
AJ-26	PID3 scale adjustment (decimal point position)	0 to 4	2
AJ-27	PID3 set-point input source selection	00(Not used)/ 01(Terminal[Ai1])/ 02(Terminal[Ai2])/ 03(Terminal[Ai3])/ 04(Terminal[Ai4])/ 05(Terminal[Ai5])/ 06(Terminal[Ai6])/ 07(Parameter setting)/ 08(RS485)/ 09(Option-1)/ 10(Option-2)/ 11(Option-3)/ 12(Pulse train input(Internal))/ 13(Pulse train input(Option))	07
AJ-30	PID3 set-point setting	Range will depend on the parameters [AJ-24], [AJ-25], [AJ-26] -100.00 to 100.00 (%)	0.00
AJ-32	PID3 feedback input source selection	00(Not used)/ 01(Terminal[Ai1])/ 02(Terminal[Ai2])/ 03(Terminal[Ai3])/ 04(Terminal[Ai4])/ 05(Terminal[Ai5])/ 06(Terminal[Ai6])/ 08(RS485)/ 09(Option-1)/ 10(Option-2)/ 11(Option-3)/ 12(Pulse train input(Internal))/ 13(Pulse train input(Option))	01
AJ-33	PID3 proportional gain	0.0 to 100.0	1.0
AJ-34	PID3 integral time constant	0.0 to 3600.0 (sec)	1.0
AJ-35	PID3 derivative gain	0.00 to 100.00 (sec)	0.00
AJ-36	PID3 output range		0.00
AJ-37	PID3 over deviation level		3.00
AJ-38	Turn-off level for the PID3 feedback compare signal	0.00 to 100.00 (%)	100.00
AJ-39	Turn-on level for the PID3 feedback compare signal		0.00
AJ-41	PID4 enable	00(Disable)/ 01(Enable)/ 02(Enable (with inverted output))	00
AJ-42	PID4 deviation inversion	00(Disable)/ 01(Enable)	00
AJ-43	PID4 unit selection	Same as [AH-03]	01
AJ-44	PID4 scale adjustment (0%)	-10000 to 10000	0
AJ-45	PID4 scale adjustment (100%)	-10000 to 10000	10000
AJ-46	PID4 scale adjustment (decimal point position)	0 to 4	2
AJ-47	PID4 set-point input source selection	00(Not used)/ 01(Terminal[Ai1])/ 02(Terminal[Ai2])/ 03(Terminal[Ai3])/ 04(Terminal[Ai4])/ 05(Terminal[Ai5])/ 06(Terminal[Ai6])/ 07(Parameter setting)/ 08(RS485)/ 09(Option-1)/ 10(Option-2)/ 11(Option-3)/ 12(Pulse train input(Internal))/ 13(Pulse train input(Option))	07
AJ-50	PID4 set-point setting	Range will depend on the parameters [AJ-44], [AJ-45], [AJ-46] -100.00 to 100.00 (%)	0.00
AJ-52	PID4 feedback input source selection	00(Not used)/ 01(Terminal[Ai1])/ 02(Terminal[Ai2])/ 03(Terminal[Ai3])/ 04(Terminal[Ai4])/ 05(Terminal[Ai5])/ 06(Terminal[Ai6])/ 08(RS485)/ 09(Option-1)/ 10(Option-2)/ 11(Option-3)/ 12(Pulse train input(Internal))/ 13(Pulse train input(Option))	01
AJ-53	PID4 proportional gain	0.0 to 100.0	1.0
AJ-54	PID4 integral time constant	0.0 to 3600.0 (sec)	1.0
AJ-55	PID4 derivative gain	0.00 to 100.00 (sec)	0.00
AJ-56	PID4 output range		0.00
AJ-57	PID4 over deviation level		3.00
AJ-58	Turn-off level for the PID4 feedback compare signal	0.00 to 100.00 (%)	100.00
AJ-59	Turn-on level for the PID4 feedback compare signal		0.00

Parameter mode (B code)

Code No.	Parameter Meaning	Selectable User Setting	Initial value
bA101	Upper frequency limit source selection, 1st-motor	00(Disable)/ 01(Terminal[Ai1])/ 02(Terminal[Ai2])/ 03(Terminal[Ai3])/ 04(Terminal[Ai4])/ 05(Terminal[Ai5])/ 06(Terminal[Ai6])/ 07(Parameter Setting)/ 08(RS485)/ 09(Option-1)/ 10(Option-2)/ 11(Option-3)/ 12(Pulse train input(Internal))/ 13(Pulse train input(Option))	00
bA102	Upper frequency limit, 1st-motor	0.00 to 590.00 (Hz)	0.00
bA103	Lower frequency limit, 1st-motor	0.00 to 590.00 (Hz)	0.00
bA110	Torque limit selection, 1st-motor	00(Disable)/ 01(Terminal[Ai1])/ 02(Terminal[Ai2])/ 03(Terminal[Ai3])/ 04(Terminal[Ai4])/ 05(Terminal[Ai5])/ 06(Terminal[Ai6])/ 07(Parameter Setting)/ 08(RS485)/ 09(Option-1)/ 10(Option-2)/ 11(Option-3)	07
bA111	Torque limiting parameters mode selection, 1st-motor	00(4 quadrants)/ 01(Switched by [TRQ1][TRQ2] terminals)	00
bA112	Torque limit 1 (Forward drive), 1st-motor	0.0 to 500.0 (%)	150.0
bA113	Torque limit 2 (Reverse regenerative), 1st-motor		
bA114	Torque limit 3 (Reverse drive), 1st-motor		
bA115	Torque limit 4 (Forward regenerative), 1st-motor		
bA116	Torque limit LADSTOP selection, 1st-motor	00(Disable)/ 01(Enable)	00
bA120	Overcurrent suppression enable, 1st-motor	00(Disable)/ 01(Enable)	01
bA121	Overcurrent suppression level, 1st-motor	(0.00 to 2.00)* Inverter rated current (A)	1.80 *Inverter rated current
bA122	Overload restriction 1 mode selection, 1st-motor	00(Disable)/ 01(Enable during accel. and constant speed)/ 02(Constant speed only)/ 03(Enable during accel. and constant speed(accel. during regeneration))	01
bA123	Overload restriction 1 active level, 1st-motor	(0.20 to 2.00)* Inverter rated current (A)	1.50 *Inverter rated current
bA124	Overload restriction 1 action time, 1st-motor	0.10 to 3600.00 (sec)	1.00
bA126	Overload restriction 2 mode selection, 1st-motor	00(Disable)/ 01(Enable during accel. and constant speed)/ 02(Constant speed only)/ 03(Enable during accel. and constant speed(accel. during regeneration))	01
bA127	Overload restriction 2 active level, 1st-motor	(0.20 to 2.00)* Inverter rated current (A)	1.50 *Inverter rated current
bA128	Overload restriction 2 action time, 1st-motor	0.10 to 3600.00 (sec)	1.00
bA-30	Instantaneous power failure non-stop function, mode selection	00(Disable)/ 01(Deceleration-stop)/ 02(Voltage controlled decel-stop(without recovery))/ 03(Voltage controlled decel-stop (with recovery))	00
bA-31	Instantaneous power failure non-stop function, start voltage level	0.0 to 410.0 (Vdc) (200V class) 0.0 to 820.0 (Vdc) (400V class)	(200V class) 220.00 (400V class) 440.00
bA-32	Instantaneous power failure non-stop function, target voltage level		(200V class) 360.00 (400V class) 720.00
bA-34	Instantaneous power failure non-stop function, deceleration time	0.01 to 3600.00 (sec)	1.00
bA-36	Instantaneous power failure non-stop function, start frequency decrement	0.00 to 10.00 (Hz)	0.00
bA-37	Instantaneous power failure non-stop function, DC bus voltage control P gain	0.00 to 5.00	0.20
bA-38	Instantaneous power failure non-stop function, DC bus voltage control I gain	0.00 to 150.00 (sec)	1.00
bA140	Overvoltage suppression enable setting, 1st-motor	00(Disable)/ 01(Constant DC bus voltage control(deceleration stop))/ 02(Enable acceleration)/ 03(Enable acceleration (at constant speed and deceleration))	00
bA141	Overvoltage suppression active level, 1st-motor	330.0 to 400.0 (Vdc) (200V class) 660.0 to 800.0 (Vdc) (400V class)	(200V class) 380.00 (400V class) 760.00
bA142	Overvoltage suppression active time, 1st-motor	0.00 to 3600.00 (sec)	1.00
bA144	Constant DC bus voltage control P gain, 1st-motor	0.00 to 5.00	0.20
bA145	Constant DC bus voltage control I gain, 1st-motor	0.00 to 150.00 (sec)	1.00
bA146	Over-magnetization function selection, 1st-motor	00(Disable)/ 01(Always enable)/ 02(At deceleration only)/ 03(Operation at setting level)/ 04(Operation at setting level at deceleration only)	02
bA147	Over-magnetization function output filter time constant, 1st-motor	0.00 to 1.00 (sec)	0.30
bA148	Over-magnetization function voltage gain, 1st-motor	50 to 400 (%)	100
bA149	Over-magnetization function level setting, 1st-motor	330.0 to 400.0 (Vdc) (200V class) 660.0 to 800.0 (Vdc) (400V class)	(200V class) 360.00 (400V class) 720.00
bA-60	Dynamic brake use ratio	0.0 to 10.0*((bA-63)/(Inverter minimum resistor))^2 (%)	10.0
bA-61	Dynamic brake activation selection	00(Disable)/ 01(Only while running)/ 02(Enable during stop)	00
bA-62	Dynamic brake activation level	330.0 to 400.0 (Vdc) (200V class) 660.0 to 800.0 (Vdc) (400V class)	(200V class) 360.00 (400V class) 720.00
bA-63	Dynamic brake resistor value	Minimum resistance to 600 (Ω)	Minimum resistance (Depends on the inverter model)

Code No.	Parameter Meaning	Selectable User Setting	Initial value
bA-70	Cooling fan control method selection	00(Always ON)/ 01(While inverter operates)/ 02(Depends on temperature)	00
bA-71	Clear accumulated cooling fan run time monitor	00(Disable)/ 01(Clear)	00
bA201	Upper frequency limit source selection, 2nd-motor	00(Disable)/ 01(Terminal[Ai1])/ 02(Terminal[Ai2])/ 03(Terminal[Ai3])/ 04(Terminal[Ai4])/ 05(Terminal[Ai5])/ 06(Terminal[Ai6])/ 07(Parameter Setting)/ 08(RS485)/ 09(Option-1)/ 10(Option-2)/ 11(Option-3)/ 12(Pulse train input(Internal))/ 13(Pulse train input(Option))	00
bA202	Upper Frequency limit, 2nd-motor	0.00 to 590.00 (Hz)	0.00
bA203	Lower Frequency limit, 2nd-motor	0.00 to 590.00 (Hz)	0.00
bA210	Torque limit selection, 2nd-motor	00(Disable)/ 01(Terminal[Ai1])/ 02(Terminal[Ai2])/ 03(Terminal[Ai3])/ 04(Terminal[Ai4])/ 05(Terminal[Ai5])/ 06(Terminal[Ai6])/ 07(Parameter Setting)/ 08(RS485)/ 09(Option-1)/ 10(Option-2)/ 11(Option-3)	07
bA211	Torque limiting parameters mode selection, 2nd-motor	00(4 quadrants)/ 01(Switched by [TRQ1][TRQ2] terminals)	00
bA212	Torque limit 1 (Forward drive), 2nd-motor	0.0 to 500.0 (%)	150.0(%)
bA213	Torque limit 2 (Reverse regenerative), 2nd-motor		
bA214	Torque limit 3 (Reverse drive), 2nd-motor		
bA215	Torque limit 4 (Forward regenerative), 2nd-motor		
bA216	Torque limit LADSTOP selection, 2nd-motor		
bA220	Overcurrent suppression enable, 2nd-motor	00(Disable)/ 01(Enable)	01
bA221	Overcurrent suppression level, 2nd-motor	(0.00 to 2.00)* Inverter rated current (A)	1.80 *Inverter rated current
bA222	Overload restriction 1 mode selection, 2nd-motor	00(Disable)/ 01(Enable during accel. and constant speed)/ 02(Constant speed only)/ 03(Enable during accel. and constant speed(accel. during regeneration))	01
bA223	Overload restriction 1 active level, 2nd-motor	(0.20 to 2.00)* Inverter rated current (A)	1.50 *Inverter rated current
bA224	Overload restriction 1 action time, 2nd-motor	0.10 to 3600.00 (sec)	1.00
bA226	Overload restriction 2 mode selection, 2nd-motor	00(Disable)/ 01(Enable during accel. and constant speed)/ 02(Constant speed only)/ 03(Enable during accel. and constant speed(accel. during regeneration))	01
bA227	Overload restriction 2 active level, 2nd-motor	(0.20 to 2.00)* Inverter rated current (A)	1.50 *Inverter rated current
bA228	Overload restriction 2 action time, 2nd-motor	0.10 to 3600.00 (sec)	1.00
bA240	Overvoltage suppression enable, 2nd-motor	00(Disable)/ 01(Constant DC bus voltage control(deceleration stop))/ 02(Enable acceleration)/ 03(Enable acceleration (atconstant speed and deceleration))	00
bA241	Overvoltage suppression active level, 2nd-motor	330.0 to 400.0 (Vdc) (200V class) 660.0 to 800.0 (Vdc) (400V class)	(200V class) 380.0 (400V class) 760.0
bA242	Overvoltage suppression active time, 2nd-motor	0.00 to 3600.00 (sec)	1.00
bA244	Constant DC bus voltage control P gain, 2nd-motor	0.00 to 5.00	0.20
bA245	Constant DC bus voltage control I gain, 2nd-motor	0.00 to 150.00 (sec)	1.00
bA246	Over magnetization function selection, 2nd-motor	00(Disable)/ 01(Always enable)/ 02(At deceleration only)/ 03(Operation at setting level)/ 04(Operation at setting level at deceleration only)	02
bA247	Over magnetization function output filter time constant, 2nd-motor	0.00 to 1.00 (sec)	0.30
bA248	Over magnetization function voltage gain, 2nd-motor	50 to 400 (%)	100
bA249	Over magnetization function level setting, 2nd-motor	330.0 to 400.0 (Vdc) (200V class) 660.0 to 800.0 (Vdc) (400V class)	(200V class) 360.0 (400V class) 720.0
bb101	Carrier frequency setting, 1st-motor	[Ub-03]=02(ND): 0.5 to 16.0 (kHz) (Until P1-02950-L/P1-01470-H) [Ub-03]=02(ND): 0.5 to 10.0 (kHz) (Above P1-02950-L/P1-01470-H) [Ub-03]=01(LD): 0.5 to 12.0 (kHz) (Until P1-02950-L/P1-01470-H) [Ub-03]=01(LD): 0.5 to 8.0 (kHz) (Above P1-02950-L/P1-01470-H) [Ub-03]=00(VLD): 0.5 to 10.0 (kHz) (Until P1-02950-L/P1-01470-H) [Ub-03]=00(VLD): 0.5 to 8.0 (kHz) (Above P1-02950-L/P1-01470-H)	2.0
bb102	Sprinkle carrier pattern selection, 1st-motor	00(Disable)/ 01(Enable: Patern-1)/ 02(Enable: Patern-2)/ 03(Enable: Patern-3)	00
bb103	Automatic carrier reduction selection, 1st-motor	00(Disable)/ 01(Enable: Current)/ 02(Enable: Temperature)	00
bb-10	Automatic error reset selection	00(Disable)/ 01(If RUN command is OFF)/ 02(After set time)	00
bb-11	Alarm signal selection at automatic error reset	00(Enable)/ 01(Disable)	00
bb-12	Automatic error reset wait time	0 to 600 (sec)	2
bb-13	Automatic error reset number	0 to 10	3
bb-20	Number of retries after instantaneous power failure	0 to 16/ 255	0
bb-21	Number of retries after under voltage		0
bb-22	Number of retries after overcurrent		0
bb-23	Number of retries after over voltage	0 to 5	0

Code No.	Parameter Meaning	Selectable User Setting	Initial value
bb-24	Restart mode selection after instantaneous power failure/under-voltage error	00(Restart at 0Hz)/ 01(Restart with frequency matching)/ 02(Restart with active frequency matching)/ 03(Detect speed)/ 04(Decelerate and stop with frequency matching and then trip)	01
bb-25	Instantaneous power failure allowed time	0.3 to 25.0 (sec)	1.0
bb-26	Retry wait time after instantaneous power failure/under-voltage error	0.3 to 100.0 (sec)	0.3
bb-27	Enable instantaneous power failure/ under-voltage trip while in stop status	00(Disable)/ 01(Enable)/ 02(Disable at Stop/Decel. Stop)	00
bb-28	Restart mode selection after an overcurrent error	00(Restart at 0Hz)/ 01(Restart with frequency matching)/ 02(Restart with active frequency matching)/ 03(Detect speed)/ 04(Decelerate and stop with frequency matching and then trip)	01
bb-29	Retry wait time after an overcurrent error	0.3 to 100.0 (sec)	0.3
bb-30	Restart mode selection after an overvoltage error	00(Restart at 0Hz)/ 01(Restart with frequency matching)/ 02(Restart with active frequency matching)/ 03(Detect speed)/ 04(Decelerate and stop with frequency matching and then trip)	01
bb-31	Retry wait time after an overvoltage error	0.3 to 100.0 (sec)	0.3
bb-40	Restart mode after FRS release	00(Restart at 0Hz)/ 01(Restart with frequency matching)/ 02(Restart with active frequency matching)/ 03(Detect speed)	00
bb-41	Restart mode after RS release	00(Restart at 0Hz)/ 01(Restart with frequency matching)/ 02(Restart with active frequency matching)/ 03(Detect speed)	00
bb-42	Frequency matching minimum restart frequency	0.00 to 590.00 (Hz)	0.00
bb-43	Active frequency matching restart level	(0.20 to 2.00)* Inverter rated current (A)	1.00 *Inverter rated current
bb-44	Active frequency matching restart constant (speed)	0.10 to 30.00 (sec)	0.50
bb-45	Active frequency matching restart constant (voltage)		0.50
bb-46	OC-suppress level at active frequency matching	(0.00 to 2.00)* Inverter rated current (A)	1.00 *Inverter rated current
bb-47	Active frequency matching restart speed selection	00(Output frequency at shut down)/ 01(Maximum frequency)/ 02(Setting frequency)	00
bb-50	Frequency matching filter gain	0 to 1000 (%)	50
bb160	Overcurrent detection level, 1st-motor	(0.20 to 2.20)* Inverter ND rated current (A)	2.20 *Inverter ND rated current
bb-61	Power supply overvoltage selection	00(Warning)/ 01(Error)	00
bb-62	Power supply overvoltage level setting	300.0 to 410.0 (Vdc) (200V class) 600.0 to 820.0 (Vdc) (400V class)	(200V class) 390.0 (400V class) 780.0
bb-64	Detect ground fault selection	00(Disable)/ 01(Enable)	00
bb-65	Input phase loss detection enable		00
bb-66	Output phase loss detection enable		00
bb-67	Output phase loss detection sensitivity	1 to 100 (%)	10
bb-70	Thermistor error level	0 to 10000 (Ω)	3000
bb-80	Over-speed detection level	0.0 to 150.0 (%)	135.0
bb-81	Over-speed detection time	0.0 to 5.0 (sec)	0.5
bb-82	Speed deviation error mode selection	00(Warning)/ 01(Error)	00
bb-83	Speed deviation error detection level	0.0 to 100.0 (%)	15.0
bb-84	Speed deviation error detection time	0.0 to 5.0 (sec)	0.5
bb-85	Position deviation error mode selection	00(Warning)/ 01(Error)	00
bb-86	Position deviation error detection level	0 to 65535 (x100pls)	4096
bb-87	Position deviation error detection time	0.0 to 5.0 (sec)	0.5
bb201	Carrier frequency setting, 2nd-motor	[Ub-03]=02(ND): 0.5 to 16.0 (kHz) (Until P1-02950-L/P1-01470-H) [Ub-03]=02(ND): 0.5 to 10.0 (kHz) (Above P1-02950-L/P1-01470-H) [Ub-03]=01(LD): 0.5 to 12.0 (kHz) (Until P1-02950-L/P1-01470-H) [Ub-03]=01(LD): 0.5 to 8.0 (kHz) (Above P1-02950-L/P1-01470-H) [Ub-03]=00(VLD): 0.5 to 10.0 (kHz) (Until P1-02950-L/P1-01470-H) [Ub-03]=00(VLD): 0.5 to 8.0 (kHz) (Above P1-02950-L/P1-01470-H)	2.0
bb202	Sprinkle carrier pattern selection, 2nd-motor	00(Disable)/ 01(Enable: Patern-1)/ 02(Enable: Patern-2)/ 03(Enable: Patern-3)	00
bb203	Automatic-carrier reduction selection, 2nd-motor	00(Disable)/ 01(Enable: Current)/ 02(Enable: Temperature)	00
bb260	Over current detection level, 2nd-motor	(0.20 to 2.20)* Inverter ND rated current (A)	2.20 *Inverter ND rated current
bC110	Electronic thermal level setting, 1st-motor	(0.0 to 3.0)* Inverter rated current (A)	1.00 *Inverter rated current
bC111	Electronic thermal characteristic selection, 1st-motor	00(Reduced torque (VT))/ 01(Constant torque (CT))/ 02(Free setting)	00('FF') 01('FEF,FUF)
bC112	Electronic thermal decrease function enable, 1st-motor	00(Disable)/ 01(Enable)	01
bC113	Electronic thermal decreasing time, 1st-motor	1 to 1000 (sec)	600

Code No.	Parameter Meaning	Selectable User Setting	Initial value
bC-14	Store electronic thermal counter at power-off	00(Disable)/ 01(Enable)	01
bC120	Free electronic thermal frequency-1, 1st-motor	0.00 to [bC122] (Hz)	0.00
bC121	Free electronic thermal current-1, 1st-motor	(0.0 to 3.0)* Inverter rated current (A)	0.0
bC122	Free electronic thermal frequency-2, 1st-motor	[bC120] to [bC124] (Hz)	0.00
bC123	Free electronic thermal current-2, 1st-motor	(0.0 to 3.0)* Inverter rated current (A)	0.0
bC124	Free electronic thermal frequency-3, 1st-motor	[bC122] to 590.00 (Hz)	0.00
bC125	Free electronic thermal current-3, 1st-motor	(0.0 to 3.0)* Inverter rated current (A)	0.0
bC210	Electronic thermal level setting, 2nd-motor	(0.0 to 3.0)* Inverter rated current (A)	1.00 *Inverter rated current
bC211	Electronic thermal characteristic selection, 2nd-motor	00(Reduced torque (VT))/ 01(Constant torque (CT))/ 02(Free setting)	00(*FF)/ 01(*FEF,FUF)
bC212	Electronic thermal decrease function selection, 2nd-motor	00(Disable)/ 01(Enable)	01
bC213	Electronic thermal decreasing time, 2nd-motor	1 to 1000 (sec)	600
bC220	Free electronic thermal frequency-1, 2nd-motor	0.00 to [bC222] (Hz)	0.00
bC221	Free electronic thermal current-1, 2nd-motor	(0.0 to 3.0)* Inverter rated current (A)	0.0
bC222	Free electronic thermal frequency-2, 2nd-motor	[bC220] to [bC224] (Hz)	0.00
bC223	Free electronic thermal current-2, 2nd-motor	(0.0 to 3.0)* Inverter rated current (A)	0.0
bC224	Free electronic thermal frequency-3, 2nd-motor	[bC222] to 590.00 (Hz)	0.00
bC225	Free electronic thermal current-3, 2nd-motor	(0.0 to 3.0)* Inverter rated current (A)	0.0
bd-01	STO input display selection	00(Warning(display))/ 01(Warning(without display))/ 02(Trip)	00
bd-02	STO input change time	0.00 to 60.00 (sec)	1.00
bd-03	Display selection during STO input change time	00(Warning(display))/ 01(Warning(without display))	00
bd-04	Action selection after STO input change time	00(Maintain current status)/ 01(Disable)/ 02(Trip)	00

■Parameter mode (C code)

Code No.	Parameter Meaning	Selectable User Setting	Initial value
CA-01	Input terminal [1] function	000(no:Not use)/ 001(FW:Forward rotation)/ 002(RV:Reverse rotation)/ 003(CF1:Multi speed selection 1)/ 004(CF2:Multi speed selection 2)/ 005(CF3:Multi speed selection 3)/ 006(CF4:Multi speed selection 4)/ 007(SF1:Multi speed Bit-1)/ 008(SF2:Multi speed Bit-2)/ 009(SF3:Multi speed Bit-3)/ 010(SF4:Multi speed Bit-4)/ 011(SF5:Multi speed Bit-5)/ 012(SF6:Multi speed Bit-6)/ 013(SF7:Multi speed Bit-7)/ 014(ADD:Trigger for frequency addition[AA106/206])/ 015(SCHG:Main/Sub speed reference change)/ 016(STA:3-wire Start)/ 017(STP:3-wire Stop)/ 018(FR:3-wire Forward/Reverse)/ 019(AHD: analog command holding)/ 020(FUP:Remote control Speed-UP function)/ 021(FDN:Remote control Speed-DOWN function)/ 022(UDC:Remote control Speed data clearing)/ 023(F-OP:Force operation)/ 024(SET: 2nd-motor control)/ 028(RS:Reset)/ 029(JG:Jogging)/ 030(DB:External DC braking)/ 031(2CH:2-stage Acceleration/Deceleration)/ 032(FRS:Free run stop)/ 033(EXT:External fault)/ 034(USP:unattended start protection)/ 035(CS:Commercial power supply change)/ 036(SFT:Soft-Lock)/ 037(BOK:Answer back from Brake)/ 038(OLR:Overload restriction selection)/ 039(KHC:Accumulation input power clearance)/ 040(KHK:Accumulation output power clearance)/ 041(PID:Disable PID1)/ 042(PIDC:PID1 integration reset)/ 043(PID2:Disable PID2)/ 044(PIDC2:PID2 integration reset)/ 045(PID3:Disable PID3)/ 046(PIDC3:PID3 integration reset)/ 047(PID4:Disable PID4)/ 048(PIDC4:PID4 integration reset)/ 051(SVC1:Multi set-point selection 1)/ 052(SVC2:Multi set-point selection 2)/ 053(SVC3:Multi set-point selection 3)/ 054(SVC4:Multi set-point selection 4)/ 055(PRO:PID gain change)/ 056(PI01:PID output switching 1)/ 057(PI02:PID output switching 2)/ 058(SLEP:SLEEP condition activation)/ 059(WAKE:WAKE condition activation)/ 060(TL:Torque limit enable)/ 061(TRQ1:Torque limit selection bit 1)/ 062(TRQ2:Torque limit selection bit 2)/ 063(PPI:P/PI control mode selection)/ 064(CAS:Control gain change)/ 065(SON:Servo-on)/ 066(FOC:Forcing)/ 067(ATR:Permission of torque control)/ 068(TBS:Torque Bias enable)/ 069(ORT:Home search function)/ 071(LAC:Acceleration/Deceleration cancellation)/ 072(PCLR:Clearance of position deviation)/ 073(STAT:Pulse train position reference input enable)/ 074(PUP:Position bias (ADD))/ 075(PDN:Position bias (SUB))/ 076(CP1:Multistage position settings selection 1)/ 077(CP2:Multistage position settings selection 2)/ 078(CP3:Multistage position settings selection 3)/ 079(CP4:Multistage position settings selection 4)/ 080(ORL:Limit signal of Homing function)/ 081(ORG:Start signal of Homing function)/ 082(FOT:Forward Over Travel)/ 083(ROT:Reserve Over Travel)/ 084(SPD:speed / position switching)/ 085(PSET:Position data presetting)/ 086(MI1:General-purpose input 1)/ 087(MI1:General-purpose input 2)/ 088(MI1:General-purpose input 3)/ 089(MI1:General-purpose input 4)/ 090(MI1:General-purpose input 5)/ 091(MI1:General-purpose input 6)/ 092(MI1:General-purpose input 7)/ 093(MI1:General-purpose input 8)/ 094(MI9:General-purpose input 9)/ 095(MI10:General-purpose input 10)/ 096(MI11:General-purpose input 11)/ 097(PCC:Pulse counter clearing)/ 098(ECOM:EzCOM activation)/ 099(PRG:Program RUN)/ 100(HLD:Acceleration/Deceleration disable)/ 101(REN:RUN enable)/ 102(DISP:Display lock)/ 103(PLA:Pulse count A)/ 104(PLB:Pulse count B)/ 105(EMF:Emergency-Force Drive activation)/ 107(COK:Contactor check)/ 108(DTR:Data trace start)/ 109(PLZ:Pulse train input Z)/ 110(TCH:Teach-in)	028
CA-02	Input terminal [2] function		015
CA-03	Input terminal [3] function		029
CA-04	Input terminal [4] function		032
CA-05	Input terminal [5] function		031
CA-06	Input terminal [6] function		003
CA-07	Input terminal [7] function		004
CA-08	Input terminal [8] function		002
CA-09	Input terminal [9] function		001
CA-10	Input terminal [A] function		033
CA-11	Input terminal [B] function		034
CA-21 to CA-31	Input terminal [1] to [9],[A],[B] active state	00(Normally Open: NO)/ 01(Normally Closed: NC)	00
CA-41 to CA-51	Input terminal [1] to [9],[A],[B] response time	0 to 400 (ms)	2
CA-55	Multistage input determination time	0 to 2000 (ms)	0
CA-60	FUP/FDN overwrite target selection	00(Speed Reference)/ 01(PID1 set-point 1)	00
CA-61	FUP/FDN data save enable	00(Not save)/ 01(Save)	00
CA-62	FUP/FDN UDC selection	00(0Hz)/ 01(Saved data)	00
CA-64	Acceleration time setting for FUP/FDN function	0.00 to 3600.00 (sec)	30.00
CA-66	Deceleration time setting for FUP/FDN function		
CA-70	Speed reference source selection when [F-OP] is active	01(Terminal[Ai1])/ 02(Terminal[Ai2])/ 03(Terminal[Ai3])/ 04(Terminal[Ai4])/ 05(Terminal[Ai5])/ 06(Terminal[Ai6])/ 07(Parameter Setting)/ 08(RS485)/ 09(Option-1)/ 10(Option-2)/ 11(Option-3)/ 12(Pulse train input(Internal))/ 13(Pulse train input(Option))/ 14(Program function)/ 15(PID calc.)/ 16(Volume of MOP-VR)	01
CA-71	RUN command source selection when [F-OP] is active	00(FW)/ 01(RV terminal)/ 01(3-wire)/ 02(Keypad's RUN-key) / 03(RS485)/ 04(Option-1)/ 05(Option-2)/ 06(Option-3)	00

Code No.	Parameter Meaning	Selectable User Setting	Initial value
CA-72	Reset mode selection	00(Always enabled (Trip release at turn-ON))/ 01(Always enabled (Trip release at turn-OFF))/ 02(Only enable in trip status (Trip release at turn-ON))/ 03(Only enable in trip status (Trip release at turn-OFF))	00
CA-81	Encoder constant setting	32 to 65535 (pls)	1024
CA-82	Encoder phase sequence selection (Internal)	00(Phase-A Lead)/ 01(Phase-B Lead)	00
CA-83	Motor gear ratio numerator (Internal)	1 to 10000	1
CA-84	Motor gear ratio denominator (Internal)	1 to 10000	1
CA-90	Pulse train input, target function selection (Internal)	00(Disable)/ 01(Frequency reference)/ 02(Speed feedback)/ 03(Pulse count)	00
CA-91	Pulse train input mode selection (Internal)	00(90 degrees shift pulse train)/ 01(Forward/Reverse pulse train and direction signal)/ 02(Forward pulse train and reverse pulse train)	00
CA-92	Pulse train frequency scale (Internal)	0.05 to 32.00 (kHz)	25.00
CA-93	Pulse train frequency filter time constant (Internal)	0.01 to 2.00 (sec)	0.10
CA-94	Pulse train frequency bias value (Internal)	-100.0 to 100.0 (%)	0.0
CA-95	Pulse train upper frequency detection level (Internal)	0 to 100.0 (%)	100.0
CA-96	Pulse train lower frequency detection level (Internal)		0.0
CA-97	Pulse counter compare match output ON value	0 to 65535	0
CA-98	Pulse counter compare match output OFF value		0
CA-99	Pulse counter maximum value		65535
Cb-01	[Ai1] Filter time constant	1 to 500(ms)	16
Cb-03	[Ai1] Start value	0.00 to 100.00(%)	0.00
Cb-04	[Ai1] End value	0.00 to 100.00(%)	100.00
Cb-05	[Ai1] Start rate	0.0 to [Cb-06] (%)	0.0
Cb-06	[Ai1] End rate	[Cb-05] to 100.0 (%)	100.0
Cb-07	[Ai1] Start value selection	00(Start value[Cb-03])/ 01(0%)	01
Cb-11	[Ai2] Filter time constant	1 to 500(ms)	16
Cb-13	[Ai2] Start value	0.00 to 100.00(%)	0.00
Cb-14	[Ai2] End value	0.00 to 100.00(%)	100.00
Cb-15	[Ai2] Start rate	0.0 to [Cb-16] (%)	20.0
Cb-16	[Ai2] End rate	[Cb-15] to 100.0 (%)	100.0
Cb-17	[Ai2] Start value selection	00(Start value[Cb-13])/ 01(0%)	01
Cb-21	[Ai3] Filter time constant	1 to 500(ms)	16
Cb-22	Terminal [Ai3] selection	00(Single)/ 01(Added to Ai1/Ai2: Forward and Reverse)/ 02(Added to Ai1/Ai2: Forward only)	00
Cb-23	[Ai3] Start value	-100.00 to 100.00 (%)	-100.00
Cb-24	[Ai3] End value	-100.00 to 100.00 (%)	100.00
Cb-25	[Ai3] Start rate	-100.0 to [Cb-26] (%)	-100.0
Cb-26	[Ai3] End rate	[Cb-25] to 100.0 (%)	100.0
Cb-30	[Ai1] Voltage/Current bias adjustment	-100.00 to 100.00 (%)	0.00
Cb-31	[Ai1] Voltage/Current gain adjustment	0 to 200.00 (%)	100.00
Cb-32	[Ai2] Voltage/Current bias adjustment	-100.00 to 100.00 (%)	0.00
Cb-33	[Ai2] Voltage/Current gain adjustment	0 to 200.00 (%)	100.00
Cb-34	[Ai3] Voltage bias adjustment	-100.00 to 100.00 (%)	0.00
Cb-35	[Ai3] Voltage gain adjustment	0 to 200.00 (%)	100.00
Cb-40	Thermistor type selection	00(Disable)/ 01(PTC)/ 02(NTC)	00
Cb-41	Thermistor gain adjustment	0.0 to 1000.0	100.0
Cb-51	MOP-VR input filter time constant	1 to 500	100
Cb-53	MOP-VR start value	0.00 to 100.00(%)	0.00
Cb-54	MOP-VR end value	0.00 to 100.00(%)	100.00
Cb-55	MOP-VR start ratio	0.0 to [Cb-56] (%)	0.0
Cb-56	MOP-VR end ratio	[Cb-55] to 100.0 (%)	100.0
Cb-57	MOP-VR start selection	00(Start value[Cb-53])/ 01(0%)	01

Code No.	Parameter Meaning	Selectable User Setting	Initial value
CC-01	Output terminal [11] function	000(no:Not use)/ 001(RUN:Running)/ 002(FA1:Constant-frequency reached)/ 003(FA2:Set frequency overreached)/ 004(FA3:Set frequency reached)/ 005(FA4:Set frequency overreached 2)/ 006(FA5:Set frequency reached 2)/ 007(IRDY:Inverter ready)/ 008(FWR:Forward rotation)/ 009(RVR:Reverse rotation)/ 010(FREF:Frequency reference = Keypad is selected)/ 011(REF:Run command = Keypad is selected)/ 012(SETM:2nd control is selected)/ 016(OPO:Option output)/ 017(AL:Alarm)/ 018(MJA:Major failure)/ 019(OTQ:Over-torque)/ 020(IP:Instantaneous power failure)/ 021(UV:Undervoltage)/ 022(TRQ:Torque limited)/ 023(IPS:IP-Non stop function is active)/ 024(RNT:Accumulated operation time over)/ 025(ONT:Accumulated power-on time over)/ 026(THM:Electronic thermal alarm (Motor))/ 027(THC:Electronic thermal alarm (Inverter))/ 029(WAC:Capacitor life warning)/ 030(WAF:Cooling-fan speed drop)/ 031(FR:RUN command active)/ 032(OHF:Heat sink overheat warning)/ 033(LOC:Low-current indication)/ 034(LOC2:Low-current indication 2)/ 035(OL:Overload warning notice)/ 036(OL2:Overload warning notice 2)/ 037(BRK:Brake release)/ 038(BER:Brake error)/ 039(CON:Contactor control)/ 040(ZS:Zero speed detection)/ 041(DSE:Speed over deviation)/ 042(PDD:Position over deviation)/ 043(POK:Positioning completed)/ 044(PCMP:Pulse count compare match output)/ 045(OD:Over deviation for PID control)/ 046(FBV:PID1 feedback comparison)/ 047(OD2:Over deviation for PID2 control)/ 048(FBV2:PID2 feedback comparison)/ 049(NDC:Communication line disconnection)/ 050(Ai1Dc:Analog [Ai1] disconnection detection)/ 051(Ai2Dc:Analog [Ai2] disconnection detection)/ 052(Ai3Dc:Analog [Ai3] disconnection detection)/ 053(Ai4Dc:Analog [Ai4] disconnection detection)/ 054(Ai5Dc:Analog [Ai5] disconnection detection)/ 055(Ai6Dc:Analog [Ai6] disconnection detection)/ 056(WCAi1:Window comparator Ai1)/ 057(WCAi1:Window comparator Ai2)/ 058(WCAi3:Window comparator Ai3)/ 059(WCAi4:Window comparator Ai4)/ 060(WCAi5:Window comparator Ai5)/ 061(WCAi6:Window comparator Ai6)/ 062(LOG1:Logical operation result 1)/ 063(LOG2:Logical operation result 2)/ 064(LOG3:Logical operation result 3)/ 065(LOG4:Logical operation result 4)/ 066(LOG5:Logical operation result 5)/ 067(LOG6:Logical operation result 6)/ 068(LOG7:Logical operation result 7)/ 069(MO1:General-purpose output 1)/ 070(MO2:General-purpose output 2)/ 071(MO3:General-purpose output 3)/ 072(MO4:General-purpose output 4)/ 073(MO5:General-purpose output 5)/ 074(MO6:General-purpose output 6)/ 075(MO7:General-purpose output 7)/ 076(EMFC:Emergency force drive indicator)/ 077(EMBP:By-pass mode indicator)/ 078(WFT:Trace function waiting for trigger)/ 079(TRA:Trace function data logging)/ 080(LBK:Low-battery of keypad)/ 081(OVS:Over-Voltage power supply)/ 084(AC0:Alarm code bit-0)/ 085(AC1:Alarm code bit-1)/ 086(AC2:Alarm code bit-2)/ 087(AC3:Alarm code bit-3)/ 089(OD3:Over deviation for PID3 control)/ 090(FBV3:PID3 feedback comparison)/ 091(OD4:Over deviation for PID4 control)/ 092(FBV4:PID4 feedback comparison)/ 093(SSE:PID soft start error)	001
CC-02	Output terminal [12] function		002
CC-03	Output terminal [13] function		003
CC-04	Output terminal [14] function		007
CC-05	Output terminal [15] function		035
CC-06 *1	Output terminal [16] function		000*1
CC-07	Output terminal [AL] function		017
CC-11 to 16	Output terminal [11] to [16] active state	00(Normally Open: NO)/ 01(Normally Closed: NC)	00
CC-17	Relay output terminal [AL] active state		01
CC-20	Output terminal [11] on-delay time	0.00 to 100.00(s)	0.00
CC-21	Output terminal [11] off-delay time		
CC-22	Output terminal [12] on-delay time		
CC-23	Output terminal [12] off-delay time		
CC-24	Output terminal [13] on-delay time		
CC-25	Output terminal [13] off-delay time		
CC-26	Output terminal [14] on-delay time		
CC-27	Output terminal [14] off-delay time		
CC-28	Output terminal [15] on-delay time		
CC-29	Output terminal [15] off-delay time		
CC-30	Output terminal [16] on-delay time		
CC-31	Output terminal [16] off-delay time		
CC-32	Output terminal [AL] on-delay time		

*1) For version prior to Ver.2.02 the initial value for this parameter is 040.

Code No.	Parameter Meaning	Selectable User Setting	Initial value
CC-33	Output terminal [AL] off-delay time	0.00 to 100.00(s)	0.00
CC-40	LOG1 operand-1 selection	Same as [CC-01]	000
CC-41	LOG1 operand-2 selection	Same as [CC-01]	000
CC-42	LOG1 logical calculation selection	00(AND)/ 01(OR)/ 02(XOR)	00
CC-43	LOG2 operand-1 selection	Same as [CC-01]	000
CC-44	LOG2 operand-2 selection	Same as [CC-01]	000
CC-45	LOG2 logical calculation selection	00(AND)/ 01(OR)/ 02(XOR)	00
CC-46	LOG3 operand-1 selection	Same as [CC-01]	000
CC-47	LOG3 operand-2 selection	Same as [CC-01]	000
CC-48	LOG3 logical calculation selection	00(AND)/ 01(OR)/ 02(XOR)	00
CC-49	LOG4 operand-1 selection	Same as [CC-01]	000
CC-50	LOG4 operand-2 selection	Same as [CC-01]	000
CC-51	LOG4 logical calculation selection	00(AND)/ 01(OR)/ 02(XOR)	00
CC-52	LOG5 operand-1 selection	Same as [CC-01]	000
CC-53	LOG5 operand-2 selection	Same as [CC-01]	000
CC-54	LOG5 logical calculation selection	00(AND)/ 01(OR)/ 02(XOR)	00
CC-55	LOG6 operand-1 selection	Same as [CC-01]	000
CC-56	LOG6 operand-2 selection	Same as [CC-01]	000
CC-57	LOG6 logical calculation selection	00(AND)/ 01(OR)/ 02(XOR)	00
CC-58	LOG7 operand-1 selection	Same as [CC-01]	000
CC-59	LOG7 operand-2 selection	Same as [CC-01]	000
CC-60	LOG7 logical calculation selection	00(AND)/ 01(OR)/ 02(XOR)	00
Cd-01	[FM] Output wave form selection	00(PWM output) / 01(Frequency output)	00
Cd-02	[FM] Output base frequency (at frequency output)	0 to 3600 (Hz)	2880
Cd-03	[FM] Output monitor selection	dA-01:Output frequency monitor dA-02:Output current monitor dA-04:Frequency reference monitor (after calculation) dA-08:Detect speed monitor dA-12:Output frequency monitor (signed) dA-14:Frequency upper limit monitor dA-15:Torque reference monitor (after calculation) dA-16:Torque limit monitor dA-17:Output torque monitor dA-18:Output voltage monitor dA-30:Input power monitor dA-34:Output power monitor dA-38:Motor temperature monitor dA-40:DC bus voltage monitor dA-41:BRD load rate monitor dA-42:Electronic thermal load rating monitor (Motor) dA-43:Electronic thermal load rating monitor (Inverter) dA-61:Analog input [Ai1] monitor dA-62:Analog input [Ai2] monitor dA-63:Analog input [Ai3] monitor dA-64:Analog input [Ai4] monitor dA-65:Analog input [Ai5] monitor dA-66:Analog input [Ai6] monitor dA-70:Pulse train input monitor (Internal) dA-71:Pulse train input monitor (Option) dB-18:Analog output monitor YA0 dB-19:Analog output monitor YA1 dB-20:Analog output monitor YA2 dB-21:Analog output monitor YA3 dB-22:Analog output monitor YA4 dB-23:Analog output monitor YA5 dB-30:PID1 feedback value 1 monitor dB-32:PID1 feedback value 2 monitor dB-34:PID1 feedback value 3 monitor dB-36:PID2 feedback value monitor dB-38:PID3 feedback value monitor dB-40:PID4 feedback value monitor dB-42:PID1 target value monitor dB-44:PID1 feedback value monitor dB-50:PID1 output monitor dB-51:PID1 deviation monitor dB-52:PID1 deviation 1 monitor dB-53:PID1 deviation 2 monitor dB-54:PID1 deviation 3 monitor dB-55:PID2 output monitor dB-56:PID2 deviation monitor dB-57:PID3 output monitor dB-58:PID3 deviation monitor dB-59:PID4 output monitor dB-60:PID4 deviation monitor dB-64:PID feedforward monitor dC-15:Cooling fin temperature monitor FA-01:Main speed reference monitor FA-02:Sub-speed reference monitor FA-15:Torque reference monitor FA-16:Torque bias monitor FA-30:PID1 set-point 1 monitor FA-32:PID1 set-point 2 monitor FA-34:PID1 set-point 3 monitor FA-36:PID2 set-point monitor FA-38:PID3 set-point monitor FA-40:PID4 set-point monitor	[dA-01]
Cd-04	[Ao1] Output monitor selection	db-18:Analog output monitor YA0 dB-19:Analog output monitor YA1 dB-20:Analog output monitor YA2 dB-21:Analog output monitor YA3 dB-22:Analog output monitor YA4 dB-23:Analog output monitor YA5 dB-30:PID1 feedback value 1 monitor dB-32:PID1 feedback value 2 monitor dB-34:PID1 feedback value 3 monitor dB-36:PID2 feedback value monitor dB-38:PID3 feedback value monitor dB-40:PID4 feedback value monitor dB-42:PID1 target value monitor dB-44:PID1 feedback value monitor dB-50:PID1 output monitor dB-51:PID1 deviation monitor dB-52:PID1 deviation 1 monitor dB-53:PID1 deviation 2 monitor dB-54:PID1 deviation 3 monitor dB-55:PID2 output monitor dB-56:PID2 deviation monitor dB-57:PID3 output monitor dB-58:PID3 deviation monitor dB-59:PID4 output monitor dB-60:PID4 deviation monitor dB-64:PID feedforward monitor dC-15:Cooling fin temperature monitor FA-01:Main speed reference monitor FA-02:Sub-speed reference monitor FA-15:Torque reference monitor FA-16:Torque bias monitor FA-30:PID1 set-point 1 monitor FA-32:PID1 set-point 2 monitor FA-34:PID1 set-point 3 monitor FA-36:PID2 set-point monitor FA-38:PID3 set-point monitor FA-40:PID4 set-point monitor	[dA-01]
Cd-05	[Ao2] Output monitor selection	db-18:Analog output monitor YA0 dB-19:Analog output monitor YA1 dB-20:Analog output monitor YA2 dB-21:Analog output monitor YA3 dB-22:Analog output monitor YA4 dB-23:Analog output monitor YA5 dB-30:PID1 feedback value 1 monitor dB-32:PID1 feedback value 2 monitor dB-34:PID1 feedback value 3 monitor dB-36:PID2 feedback value monitor dB-38:PID3 feedback value monitor dB-40:PID4 feedback value monitor dB-42:PID1 target value monitor dB-44:PID1 feedback value monitor dB-50:PID1 output monitor dB-51:PID1 deviation monitor dB-52:PID1 deviation 1 monitor dB-53:PID1 deviation 2 monitor dB-54:PID1 deviation 3 monitor dB-55:PID2 output monitor dB-56:PID2 deviation monitor dB-57:PID3 output monitor dB-58:PID3 deviation monitor dB-59:PID4 output monitor dB-60:PID4 deviation monitor dB-64:PID feedforward monitor dC-15:Cooling fin temperature monitor FA-01:Main speed reference monitor FA-02:Sub-speed reference monitor FA-15:Torque reference monitor FA-16:Torque bias monitor FA-30:PID1 set-point 1 monitor FA-32:PID1 set-point 2 monitor FA-34:PID1 set-point 3 monitor FA-36:PID2 set-point monitor FA-38:PID3 set-point monitor FA-40:PID4 set-point monitor	[dA-01]
Cd-10	Analog monitor adjustment mode enable	00(Disable)/ 01(Enable)	00
Cd-11	[FM] Output filter time constant	1 to 500 (ms)	100
Cd-12	[FM] Data type selection	00(Absolute data)/ 01(Signed data)	00
Cd-13	[FM] Bias adjustment	-100.0 to 100.0 (%)	0.0

Code No.	Parameter Meaning	Selectable User Setting	Initial value
Cd-14	[FM] Gain adjustment	-1000.0 to 1000.0 (%)	100.0
Cd-15	Adjustment mode [FM] output level	-100.0 to 100.0 (%)	100.0
Cd-21	[Ao1] Output filter time constant	1 to 500 (ms)	100
Cd-22	[Ao1] Data type selection	00(Absolute data)/ 01(Signed data)	00
Cd-23	[Ao1] Bias adjustment (Voltage/Current)	-100.0 to 100.0 (%)	0.0
Cd-24	[Ao1] Gain adjustment (Voltage/Current)	-1000.0 to 1000.0 (%)	100.0
Cd-25	Adjustment mode [Ao1] output level	-100.0 to 100.0 (%)	100.0
Cd-31	[Ao2] Output filter time constant	1 to 500 (ms)	100
Cd-32	[Ao2] Data type selection	00(Absolute data)/ 01(Signed data)	00
Cd-33	[Ao2] Bias adjustment (Voltage/Current)	-100.0 to 100.0 (%)	20.0
Cd-34	[Ao2] Gain adjustment (Voltage/Current)	-1000.0 to 1000.0 (%)	80.0*1)
Cd-35	Adjustment mode [Ao2] output level	-100.0 to 100.0 (%)	100.0
CE101	Low current signal output mode selection, 1st motor	00(During Accel./Decel. and constant speed)/ 01(During constant speed only)	01
CE102	Low current detection level 1, 1st motor	(0.00 to 2.00)* Inverter rated current (A)	1.00* Inverter rated current
CE103	Low current detection level 2, 1st motor	(0.00 to 2.00)* Inverter rated current (A)	1.00* Inverter rated current
CE105	Overload signal output mode selection, 1st motor	00(During Accel./Decel. and constant speed)/ 01(During constant speed only)	01
CE106	Overload warning level 1, 1st motor	(0.00 to 2.00)* Inverter rated current (A)	1.00* Inverter rated current
CE107	Overload warning level 2, 1st motor	(0.00 to 2.00)* Inverter rated current (A)	1.00* Inverter rated current
CE-10	Arrival frequency 1 value setting during acceleration	0.00 to 590.00 (Hz)	0.00
CE-11	Arrival frequency 1 value setting during deceleration	0.00 to 590.00 (Hz)	0.00
CE-12	Arrival frequency 2 value setting during acceleration	0.00 to 590.00 (Hz)	0.00
CE-13	Arrival frequency 2 value setting during deceleration	0.00 to 590.00 (Hz)	0.00
CE120	Over-torque level (Forward drive), 1st-motor	0.0 to 500.0 (%)	100.0
CE121	Over-torque level (Reverse regenerative), 1st-motor	0.0 to 500.0 (%)	100.0
CE122	Over-torque level (Reverse drive), 1st-motor	0.0 to 500.0 (%)	100.0
CE123	Over-torque level (Forward regenerative), 1st-motor	0.0 to 500.0 (%)	100.0
CE-30	Electronic thermal warning level (Motor)	0.00 to 100.00 (%)	80.00
CE-31	Electronic thermal warning level (Inverter)	0.00 to 100.00 (%)	80.00
CE-33	Zero speed detection level	0.00 to 100.00 (Hz)	0.50
CE-34	Cooling fin overheat warning level	0 to 200 (°C)	120
CE-36	Accum. RUN time (RNT) / Accum. Power-ON time (ONT) setting	0 to 100000 (hr)	0
CE-40	[Ai1] Window comparator higher limit	0 to 100 (%)	100
CE-41	[Ai1] Window comparator lower limit	0 to 100 (%)	0
CE-42	[Ai1] Window comparator hysteresis width	0 to 10 (%)	0
CE-43	[Ai2] Window comparator higher limit	0 to 100 (%)	100
CE-44	[Ai2] Window comparator lower limit	0 to 100 (%)	0
CE-45	[Ai2] Window comparator hysteresis width	0 to 10 (%)	0
CE-46	[Ai3] Window comparator higher limit	-100 to 100 (%)	100
CE-47	[Ai3] Window comparator lower limit	-100 to 100 (%)	-100
CE-48	[Ai3] Window comparator hysteresis width	0 to 10 (%)	0
CE-50	[Ai1] Operation set level at disconnection or compare event	0 to 100 (%)	0
CE-51	[Ai1] Operation set level implement timing	00(Disable)/ 01(Enable(at WC*active))/ 02(Enable(at WC*de-active))	00
CE-52	[Ai2] Operation set level at disconnection or compare event	0 to 100 (%)	0
CE-53	[Ai2] Operation set level implement timing	00(Disable)/ 01(Enable(at WC*active))/ 02(Enable(at WC*de-active))	00
CE-54	[Ai3] Operation set level at disconnection or compare event	-100 to 100 (%)	0
CE-55	[Ai3] Operation set level implement timing	00(Disable)/ 01(Enable(at WC*active))/ 02(Enable(at WC*de-active))	00
CE201	Low current signal output mode selection, 2nd-motor	00(During Accel./Decel. and constant speed)/ 01(During constant speed only)	01

*1) For version prior to Ver.2.02 the initial value for this parameter is 100.

Code No.	Parameter Meaning	Selectable User Setting	Initial value
CE202	Low current detection level 1, 2nd-motor	(0.00 to 2.00)* Inverter rated current (A)	1.00* Inverter rated current
CE203	Low current detection level 2, 2nd-motor	(0.00 to 2.00)* Inverter rated current (A)	
CE205	Overcurrent signal output mode selection, 2nd-motor	00(During Accel./Decel. and constant speed)/ 01(During constant speed only)	01
CE206	Overcurrent detection level 1, 2nd-motor	(0.00 to 2.00)* Inverter rated current (A)	1.00* Inverter rated current
CE207	Overcurrent detection level 2, 2nd-motor	(0.00 to 2.00)* Inverter rated current (A)	
CE220	Over-torque level (Forward drive), 2nd-motor	0.0 to 500.0 (%)	100.0
CE221	Over-torque level (Reverse regenerative), 2nd-motor	0.0 to 500.0 (%)	
CE222	Over-torque level (Reverse drive), 2nd-motor	0.0 to 500.0 (%)	
CE223	Over-torque level (Forward regenerative), 2nd motor	0.0 to 500.0 (%)	
CF-01	RS485 communication baud rate selection	03(2400bps)/ 04(4800bps)/ 05(9600bps)/ 06(19.2kbps)/ 07(38.4kbps)/ 08(57.6kbps)/ 09(76.8kbps)/ 10(115.2kbps)	
CF-02	RS485 communication node address	1 to 247	1
CF-03	RS485 communication parity selection	00(No parity)/ 01(Even parity)/ 02(Odd parity)	00
CF-04	RS485 communication stop bit selection	01(1-bit)/ 02(2-bit)	01
CF-05	RS485 communication error selection	00(Error)/ 01(Error output after Deceleration stop)/ 02(Ignore)/ 03(Free run stop)/ 04(Deceleration stop)	02
CF-06	RS485 communication timeout setting	0.00 to 100.00 (sec)	0.00
CF-07	RS485 communication wait time setting	0 to 1000 (ms)	2
CF-08	RS485 communication mode selection	01(Modbus-RTU)/ 02(EzCOM)/ 03(EzCOM Administrator)	01
CF-11	Register data conversion function (A,V / %)	00(A,V) / 01(%)	00
CF-20	EzCOM start node No.	1 to 8	1
CF-21	EzCOM end node No.	1 to 8	1
CF-22	EzCOM start method selection	00(Terminal [EzCOM]) / 01(Always)	00
CF-23	EzCOM data size	1 to 5	5
CF-24	EzCOM destination address 1	1 to 247	1
CF-25	EzCOM destination register 1	0000 to FFFF	0000
CF-26	EzCOM source register 1	0000 to FFFF	0000
CF-27	EzCOM destination address 2	1 to 247	2
CF-28	EzCOM destination register 2	0000 to FFFF	0000
CF-29	EzCOM source register 2	0000 to FFFF	0000
CF-30	EzCOM destination address 3	1 to 247	3
CF-31	EzCOM destination register 3	0000 to FFFF	0000
CF-32	EzCOM source register 3	0000 to FFFF	0000
CF-33	EzCOM destination address 4	1 to 247	4
CF-34	EzCOM destination register 4	0000 to FFFF	0000
CF-35	EzCOM source register 4	0000 to FFFF	0000
CF-36	EzCOM destination address 5	1 to 247	5
CF-37	EzCOM destination register 5	0000 to FFFF	0000
CF-38	EzCOM source register 5	0000 to FFFF	0000
CF-50	USB communication node address	1 to 247	1

Parameter mode (H code)

Code No.	Parameter Meaning	Selectable User Setting	Initial value
HA-01	Auto-tuning selection	00(Disable)/ 01(No-rotation)/ 02(Rotation)/ 03(IVMS)	00
HA-02	Auto-tuning RUN command source selection	00(Keypad "RUN" key)/ 01(Setting by AA111/AA211)	00
HA-03	Online auto-tuning selection	00(Disable)/ 01(Enable)	00
HA110	Stabilization constant, 1st-motor	0 to 1000 (%)	100
HA112	Stabilization ramp function end ratio, 1st-motor	0 to 100 (%)	30
HA113	Stabilization ramp function start ratio, 1st-motor		10
HA115	Speed response, 1st-motor		100
HA120	ASR gain switching mode selection, 1st-motor	00([CAS] terminal)/ 01(Parameter setting)	00
HA121	ASR gain switching time setting, 1st-motor	0 to 10000 (ms)	100
HA122	ASR gain mapping intermediate speed 1, 1st-motor	0.00 to 590.00 (Hz)	0.00
HA123	ASR gain mapping intermediate speed 2, 1st-motor		
HA124	ASR gain mapping maximum speed, 1st-motor		
HA125	ASR gain mapping P-gain 1, 1st-motor		
HA126	ASR gain mapping I-gain 1, 1st-motor	0.0 to 1000.0 (%)	100.0
HA127	ASR gain mapping P control P-gain 1, 1st-motor		
HA128	ASR gain mapping P-gain 2, 1st-motor		
HA129	ASR gain mapping I-gain 2, 1st-motor		
HA130	ASR gain mapping P control P-gain 2, 1st-motor		
HA131	ASR gain mapping P-gain 3, 1st-motor		
HA132	ASR gain mapping I-gain 3, 1st-motor		
HA133	ASR gain mapping P-gain 4, 1st-motor		
HA134	ASR gain mapping I-gain 4, 1st-motor		
HA210	Stabilization constant, 2nd-motor		
HA212	Stabilization ramp function end ratio, 2nd-motor	0 to 100 (%)	30
HA213	Stabilization ramp function start ratio, 2nd-motor		10
HA215	Speed response, 2nd-motor	0 to 1000 (%)	100
HA220	ASR gain switching mode selection, 2nd-motor	00([CAS] terminal)/ 01(Parameter setting)	00
HA221	ASR gain switching time setting, 2nd-motor	0 to 10000 (ms)	100
HA222	ASR gain mapping intermediate speed 1, 2nd-motor	0.00 to 590.00 (Hz)	0.00
HA223	ASR gain mapping intermediate speed 2, 2nd-motor		
HA224	ASR gain mapping maximum speed, 2nd-motor		
HA225	ASR gain mapping P-gain 1, 2nd-motor		
HA226	ASR gain mapping I-gain 1, 2nd-motor	0.0 to 1000.0 (%)	100.0
HA227	ASR gain mapping P control P-gain 1, 2nd-motor		
HA228	ASR gain mapping P-gain 2, 2nd-motor		
HA229	ASR gain mapping I-gain 2, 2nd-motor		
HA230	ASR gain mapping P control P-gain 2, 2nd-motor		
HA231	ASR gain mapping P-gain 3, 2nd-motor		
HA232	ASR gain mapping I-gain 3, 2nd-motor		
HA233	ASR gain mapping P-gain 4, 2nd-motor		
HA234	ASR gain mapping I-gain 4, 2nd-motor		
Hb102	Async. Motor capacity setting, 1st-motor		
Hb103	Async. Motor number of poles setting, 1st-motor	0 to 23 (02 to 48 poles)	1: 4P

Code No.	Parameter Meaning	Selectable User Setting	Initial value
Hb104	Async. Motor base frequency setting, 1st-motor	10.00 to [Hb105] (Hz)	60.00(*FF,*FUF)/ 50.00(*FEF)
Hb105	Async. Motor maximum frequency setting, 1st-motor	[Hb104] to 590.00 (Hz)	
Hb106	Async. Motor rated voltage, 1st-motor	1 to 1000 (V)	(200V class) 200(*FF)/ 230(*FEF,*FUF) (400V class) 400(*FF,*FEF)/ 460(*FUF)
Hb108	Async. Motor rated current, 1st-motor	0.01 to 10000.00 (A)	Depends on the inverter model
Hb110	Async. Motor constant R1, 1st-motor	0.000001 to 1000.000000 (Ω)	
Hb112	Async. Motor constant R2, 1st-motor	0.000001 to 1000.000000 (Ω)	
Hb114	Async. Motor constant L, 1st-motor	0.000001 to 1000.000000 (mH)	
Hb116	Async. Motor constant I0, 1st-motor	0.01 to 10000.00 (A)	
Hb118	Async. Motor constant J, 1st-motor	0.00001 to 10000.00000 (kgm ²)	
Hb130	Minimum frequency adjustment, 1st-motor	0.10 to 10.00 (Hz)	0.50
Hb131	Reduced voltage start time setting, 1st-motor	0 to 2000 (ms)	36
Hb140	Manual torque boost operation mode selection, 1st-motor	00(Disable)/ 01(Always enable)/ 02(Enable at Forward rotation)/ 03(Enable at Reverse rotation)	01
Hb141	Manual torque boost value, 1st-motor	0.0 to 20.0 (%)	0.0
Hb142	Manual torque boost peak speed, 1st-motor	0.0 to 50.0 (%)	0.0
Hb145	Eco drive enable, 1st-motor	00(Disable)/ 01(Enable)	00
Hb146	Eco drive response adjustment, 1st-motor	0 to 100	50
Hb150	Free-V/f frequency 1 setting, 1st-motor	0.00 to [Hb152] (Hz)	0.00
Hb151	Free-V/f voltage 1 setting, 1st-motor	0.0 to 1000.0 (V)	0.0
Hb152	Free-V/f frequency 2 setting, 1st-motor	[Hb150] to [Hb154] (Hz)	0.00
Hb153	Free-V/f voltage 2 setting, 1st-motor	0.0 to 1000.0 (V)	0.0
Hb154	Free-V/f frequency 3 setting, 1st-motor	[Hb152] to [Hb156] (Hz)	0.00
Hb155	Free-V/f voltage 3 setting, 1st-motor	0.0 to 1000.0 (V)	0.0
Hb156	Free-V/f frequency 4 setting, 1st-motor	[Hb154] to [Hb158] (Hz)	0.00
Hb157	Free-V/f voltage 4 setting, 1st-motor	0.0 to 1000.0 (V)	0.0
Hb158	Free-V/f frequency 5 setting, 1st-motor	[Hb156] to [Hb160] (Hz)	0.00
Hb159	Free-V/f voltage 5 setting, 1st-motor	0.0 to 1000.0 (V)	0.0
Hb160	Free-V/f frequency 6 setting, 1st-motor	[Hb158] to [Hb162] (Hz)	0.00
Hb161	Free-V/f voltage 6 setting, 1st-motor	0.0 to 1000.0 (V)	0.0
Hb162	Free-V/f frequency 7 setting, 1st-motor	[Hb160] to [Hb164] (Hz)	0.00
Hb163	Free-V/f voltage 7 setting, 1st-motor	0.0 to 1000.0 (V)	0.0
Hb170	Slip compensation P-gain at V/f with encoder, 1st-motor	0 to 1000 (%)	100
Hb171	Slip compensation I-gain at V/f with encoder, 1st-motor	0 to 1000 (%)	100
Hb180	Output voltage gain, 1st-motor	0 to 255 (%)	100
Hb202	Async. Motor capacity setting, 2nd-motor	0.01 to 160.00 (kW) (Until P1-02950-L/P1-03160-H) 0.01 to 500.00 (kW) (Above P1-02950-L/P1-03160-H)	Depends on the inverter model
Hb203	Async. Motor number of poles setting, 2nd-motor	0 to 23 (02 to 48 poles)	1: 4P
Hb204	Async. Motor base frequency setting, 2nd-motor	10.00 to [Hb205] (Hz)	60.00(*FF,*FUF)/ 50.00(*FEF)
Hb205	Async. Motor maximum frequency setting, 2nd-motor	[Hb204] to 590.00 (Hz)	
Hb206	Async. Motor rated voltage, 2nd-motor	1 to 1000 (V)	(200V class) 200(*FF)/ 230(*FEF,*FUF) (400V class) 400(*FF,*FEF)/ 460(*FUF)

Code No.	Parameter Meaning	Selectable User Setting	Initial value
Hb208	Async. Motor rated current, 2nd-motor	0.01 to 10000.00 (A)	Depends on the inverter model
Hb210	Async. Motor constant R1, 2nd-motor	0.000001 to 1000.000000 (Ω)	
Hb212	Async. Motor constant R2, 2nd-motor	0.000001 to 1000.000000 (Ω)	
Hb214	Async. Motor constant L, 2nd-motor	0.000001 to 1000.000000 (mH)	
Hb216	Async. Motor constant I0, 2nd-motor	0.01 to 10000.00 (A)	
Hb218	Async. Motor constant J, 2nd-motor	0.00001 to 10000.00000 (kgm ²)	
Hb230	Minimum frequency adjustment, 2nd-motor	0.10 to 10.00 (Hz)	0.50
Hb231	Reduced voltage start time setting, 2nd-motor	0 to 2000 (ms)	36
Hb240	Manual torque boost operational mode selection, 2nd-motor	00(Disable)/ 01(Always enable)/ 02(Enable at Forward rotation)/ 03(Enable at Reverse rotation)	01
Hb241	Manual torque boost value, 2nd-motor	0.0 to 20.0 (%)	0.0
Hb242	Manual torque boost Peak speed, 2nd-motor	0.0 to 50.0 (%)	0.0
Hb245	Eco drive enable, 2nd-motor	00(Disable)/ 01(Enable)	00
Hb246	Eco drive response adjustment, 2nd-motor	0 to 100	50
Hb250	Free-V/f frequency 1 setting, 2nd-motor	0.00 to [Hb252] (Hz)	0.00
Hb251	Free-V/f voltage 1 setting, 2nd-motor	0.0 to 1000.0 (V)	0.0
Hb252	Free-V/f frequency 2 setting, 2nd-motor	[Hb250] to [Hb254] (Hz)	0.00
Hb253	Free-V/f voltage 2 setting, 2nd-motor	0.0 to 1000.0 (V)	0.0
Hb254	Free-V/f frequency 3 setting, 2nd-motor	[Hb252] to [Hb256] (Hz)	0.00
Hb255	Free-V/f voltage 3 setting, 2nd-motor	0.0 to 1000.0 (V)	0.0
Hb256	Free-V/f frequency 4 setting, 2nd-motor	[Hb254] to [Hb258] (Hz)	0.00
Hb257	Free-V/f voltage 4 setting, 2nd-motor	0.0 to 1000.0 (V)	0.0
Hb258	Free-V/f frequency 5 setting, 2nd-motor	[Hb256] to [Hb260] (Hz)	0.00
Hb259	Free-V/f voltage 5 setting, 2nd-motor	0.0 to 1000.0 (V)	0.0
Hb260	Free-V/f frequency 6 setting, 2nd-motor	[Hb258] to [Hb262] (Hz)	0.00
Hb261	Free-V/f voltage 6 setting, 2nd-motor	0.0 to 1000.0 (V)	0.0
Hb262	Free-V/f frequency 7 setting, 2nd-motor	[Hb260] to [Hb264] (Hz)	0.00
Hb263	Free-V/f voltage 7 setting, 2nd-motor	0.0 to 1000.0 (V)	0.0
Hb270	Slip compensation P-gain at V/f with encoder, 2nd-motor	0 to 1000 (%)	100
Hb271	Slip compensation I-gain at V/f with encoder, 2nd-motor	0 to 1000 (%)	100
Hb280	Output voltage gain, 2nd-motor	0 to 255 (%)	100
HC101	Automatic torque boost voltage compensation gain, 1st-motor	0 to 255 (%)	100
HC102	Automatic torque boost slip compensation gain, 1st-motor	0 to 255 (%)	100
HC110	Zero speed range limit, 1st-motor (IM-0Hz-SLV)	0 to 100 (%)	80
HC111	Boost value at start, 1st-motor (IM-SLV,IM-CLV)	0 to 50 (%)	0
HC112	Boost value at start, 1st-motor (IM-0Hz-SLV)	0 to 50 (%)	10
HC113	Secondary resistance (R2) correction, 1st-motor	00(Disable)/ 01(Enable)	00
HC114	Direction reversal protection, 1st-motor	00(Disable)/ 01(Enable)	00
HC115	Torque conversion method selection, 1st-motor	00(Torque)/ 01(Current)	00
HC120	Torque current reference filter time constant, 1st-motor	0 to 100 (ms)	2
HC121	Speed feedforward compensation gain, 1st-motor	0 to 1000 (%)	0
HC137	Flux setting level, 1st-motor	0.0 to 100.0 (%)	80.0
HC140	Forcing level, 1st-motor	0 to 1000 (%)	100
HC141	Modulation threshold 1, 1st-motor	0 to 133 (%)	115
HC142	Modulation threshold 2, 1st-motor		
HC201	Automatic torque boost voltage compensation gain, 2nd-motor	0 to 255 (%)	100

Code No.	Parameter Meaning	Selectable User Setting	Initial value	
HC202	Automatic torque boost slip compensation gain, 2nd-motor	0 to 255 (%)	100	
HC210	Zero speed range limit, 2nd-motor (IM-0Hz-SLV)	0 to 100 (%)	80	
HC211	Boost value at start, 2nd-motor (IM-SLV,IM-CLV)	0 to 50 (%)	0	
HC212	Boost value at start, 2nd-motor (IM-0Hz-SLV)	0 to 50 (%)	10	
HC213	Secondary resistor (R2) compensation enable, 2nd-motor	00(Disable)/ 01(Enable)	00	
HC214	Direction reversal protection, 2nd-motor	00(Disable)/ 01(Enable)	00	
HC215	Torque conversion method selection, 2nd-motor	00(Torque)/ 01(Current)	00	
HC220	Torque current reference filter time constant, 2nd-motor	0 to 100 (ms)	2	
HC221	Speed feedforward compensation gain, 2nd-motor	0 to 1000 (%)	0	
HC237	Flux settling level, 2nd-motor	0.0 to 100.0 (%)	80.0	
HC240	Forcing level, 2nd-motor	0 to 1000 (%)	100	
HC241	Modulation threshold 1, 2nd-motor	0 to 133 (%)	115	
HC242	Modulation threshold 2, 2nd-motor			
Hd102	Sync. Motor capacity setting, 1st-motor	0.01 to 160.00 (kW) (Until P1-02950-L/P1-03160-H) 0.01 to 500.00 (kW) (Above P1-02950-L/P1-03160-H)	Depends on the inverter model	
Hd103	Sync. Motor number of poles setting, 1st-motor	0 to 23 (02 to 48 poles)		
Hd104	Sync. Motor Base frequency setting, 1st-motor	10.00 to [Hd105] (Hz)		
Hd105	Sync. Motor Maximum frequency setting, 1st-motor	[Hd104] to 590.00 (Hz)		
Hd106	Sync. Motor rated voltage, 1st-motor	1 to 1000 (V)		
Hd108	Sync. Motor rated current, 1st-motor	0.01 to 10000.00 (A)		
Hd110	Sync. Motor constant R, 1st-motor	0.000001 to 1000.000000 (Ω)		
Hd112	Sync. Motor constant Ld, 1st-motor	0.000001 to 1000.000000 (mH)		
Hd114	Sync. Motor constant Lq, 1st-motor	0.000001 to 1000.000000 (mH)		
Hd116	Sync. Motor constant Ke, 1st-motor	0.1 to 100000.0 (mVs/rad)		
Hd118	Sync. Motor constant J, 1st-motor	0.00001 to 10000.00000 (kgm ²)		
Hd130	Minimum frequency adjustment for Sync.M, 1st-motor	0 to 50 (%)		8
Hd131	No-Load current for Sync. M, 1st-motor	0 to 100 (%)		10
Hd132	Starting method for Sync. M, 1st-motor	00(Synchronous)/ 01(Initial motor position estimate (IMPE))		00
Hd133	IMPE 0V wait number for Sync.M, 1st-motor	0 to 255		10
Hd134	IMPE detect wait number for Sync.M, 1st-motor			10
Hd135	IMPE detect number for Sync.M, 1st-motor			30
Hd136	IMPE voltage gain for Sync.M, 1st-motor	0 to 200 (%)		100
Hd137	IMPE Mg-pole position offset, 1st-motor	0 to 359 (deg)	0	
Hd-41	IVMS carrier frequency	0.5 to 16.0 (kHz)	2.0	
Hd-42	Filter gain of IVMS current detection	0 to 1000	100	
Hd-43	Open-phase voltage detection gain	00(Gain 0)/ 01(Gain 1)/ 02(Gain 2)/ 03(Gain 3)	00	
Hd-44	Open-phase switching threshold compensation	00(Disable)/ 01(Enable)	01	
Hd-45	SM(PMM)-IVMS speed control P gain	0 to 1000	100	
Hd-46	SM(PMM)-IVMS speed control I gain	0 to 10000		
Hd-47	SM(PMM)-IVMS wait time for open-phase switching.	0 to 1000	15	
Hd-48	SM(PMM)-IVMS restriction on the rotation-direction determination	00(Disable)/ 01(Enable)	01	
Hd-49	SM(PMM)-IVMS open-phase voltage detection timing adjustment	0 to 1000	10	
Hd-50	SM(PMM)-IVMS minimum pulse width adjustment		100	
Hd-51	IVMS threshold current limit	0 to 255	100	
Hd-52	IVMS threshold gain			

Code No.	Parameter Meaning	Selectable User Setting	Initial value
Hd-58	IVMS carrier-frequency switching start/finish point *1)	0 to 50 (%)	5
Hd202	Sync. Motor capacity setting, 2nd-motor	0.01 to 160.00 (kW) (Until P1-02950-L/P1-03160-H) 0.01 to 500.00 (kW) (Above P1-02950-L/P1-03160-H)	Depends on the inverter model
Hd203	Sync. Motor number of poles setting, 2nd-motor	0 to 23 (02 to 48 poles)	
Hd204	Sync. Motor Base frequency setting, 2nd-motor	10.00 to [Hd205] (Hz)	
Hd205	Sync. Motor Maximum frequency setting, 2nd-motor	[Hd204] to 590.00 (Hz)	
Hd206	Sync. Motor rated voltage, 2nd-motor	1 to 1000 (V)	
Hd208	Sync. Motor rated current, 2nd-motor	0.01 to 10000.00 (A)	
Hd210	Sync. Motor constant R, 2nd-motor	0.000001 to 1000.000000 (Ω)	
Hd212	Sync. Motor constant Ld, 2nd-motor	0.000001 to 1000.000000 (mH)	
Hd214	Sync. Motor constant Lq, 2nd-motor	0.000001 to 1000.000000 (mH)	
Hd216	Sync. Motor constant Ke, 2nd-motor	0.1 to 100000.0 (mVs/rad)	
Hd218	Sync. Motor constant J, 2nd-motor	0.00001 to 10000.00000 (kgm ²)	
Hd230	Minimum frequency adjustment for Sync.M, 2nd-motor	0 to 50 (%)	
Hd231	No-Load current for Sync. M, 2nd-motor	0 to 100 (%)	10
Hd232	Starting method for Sync. M, 2nd-motor	00(Synchronous)/ 01(Initial motor position estimate (IMPE))	00
Hd233	IMPE 0V wait number for Sync.M, 2nd-motor	0 to 255	10
Hd234	IMPE detect wait number for Sync.M, 2nd-motor	0 to 255	10
Hd235	IMPE detect number for Sync.M, 2nd-motor	0 to 255	30
Hd236	IMPE voltage gain for Sync.M, 2nd-motor	0 to 200 (%)	100
Hd237	IMPE Mg-pole position offset, 2nd-motor	0 to 359 (deg)	0

*1) Depends on the base frequency

• Hd-41 to Hd-58 parameters are for adjustment in SM(PMM) driving with IVMS.

Parameter mode (O code)

Code No.	Parameter Meaning	Selectable User Setting	Initial value
oA-10	Operation selection at an option error (SLOT-1)	00(Error)/ 01(Ignore error (keep running))	00
oA-11	Communication Watch Dog Timer (SLOT-1)	0.00 to 100.00 (sec)	1.00
oA-12	Action selection at a communication error (SLOT-1)	00(Error)/ 01(Trip after Deceleration stop)/ 02(Ignore)/ 03(Free run stop)/ 04(Deceleration stop)	01
oA-13	RUN command selection at start up (SLOT-1)	00(Disable)/ 01(Enable)	00
oA-20	Operation selection at an option error (SLOT-2)	00(Error)/ 01(Ignore error (keep running))	00
oA-21	Communication Watch Dog Timer (SLOT-2)	0.00 to 100.00 (sec)	1.00
oA-22	Action selection at a communication error (SLOT-2)	00(Error)/ 01(Trip after Deceleration stop)/ 02(Ignore)/ 03(Free run stop)/ 04(Deceleration stop)	01
oA-23	RUN command selection at start up (SLOT-2)	00(Disable)/ 01(Enable)	00
oA-30	Operation selection at an option error (SLOT-3)	00(Error)/ 01(Ignore error (keep running))	00
oA-31	Communication Watch Dog Timer (SLOT-3)	0.00 to 100.00 (sec)	1.00
oA-32	Action selection at a communication error (SLOT-3)	00(Error)/ 01(Trip after Deceleration stop)/ 02(Ignore)/ 03(Free run stop)/ 04(Deceleration stop)	01
oA-33	RUN command selection at start up (SLOT-3)	00(Disable)/ 01(Enable)	00
ob-01	Encoder constant setting (Option)	32 to 65535 (pls)	1024
ob-02	Encoder phase sequence selection (Option)	00(Phase-A Lead)/ 01(Phase-B Lead)	00
ob-03	Motor gear ratio numerator (Option)	1 to 10000	1
ob-04	Motor gear ratio denominator (Option)	1 to 10000	1
ob-10	Pulse train input, target function selection (Option)	00(Frequency reference)/ 01(Pulse train position reference)	00
ob-11	Pulse train input mode selection (Option)	00(90°shift pulse train)/ 01(Forward/ Reverse pulse train and direction signal)/ 02(Forward pulse train and Reverse pulse train)	01
ob-12	Pulse train frequency scale (Option)	0.05 to 200.00 (kHz)	25.00
ob-13	Pulse train frequency filter time constant (Option)	0.01 to 2.00 (sec)	0.10
ob-14	Pulse train frequency bias value (Option)	-100.0 to 100.0 (%)	0.0
ob-15	Pulse train upper frequency detection level (Option)	0 to 100.0 (%)	100.0
ob-16	Pulse train lower frequency detection level (Option)		0.0
oC-01	Safety option input display selection	00(Warning: with display)/ 01(Warning: without display)	00
oC-10	SS1-A deceleration time setting		30.00
oC-12	SLS-A deceleration time setting	0.00 to 3600.00 (sec)	30.00
oC-14	SLS-A speed upper limit (Forward)		0.00
oC-15	SLS-A speed upper limit (Reverse)	0.00 to 590.00 (Hz)	0.00
oC-16	SDI-A deceleration time setting	0.00 to 3600.00 (sec)	30.00
oC-18	SDI-A direction limit mode	00(Limit)/ 01(Invert)	00
oC-20	SS1-B deceleration time setting		30.00
oC-22	SLS-B deceleration time setting	0.00 to 3600.00 (sec)	30.00
oC-24	SLS-B speed upper limit (Forward)		0.00
oC-25	SLS-B speed upper limit (Reverse)	0.00 to 590.00 (Hz)	0.00
oC-26	SDI-B deceleration time setting	0.00 to 3600.00 (sec)	30.00
oC-28	SDI-B direction limit mode	00(Limit)/ 01(Invert)	00
oE-01	[Ai4] Filter time constant	1 to 500 (ms)	16
oE-03	[Ai4] Start value	0.00 to 100.00 (%)	0.00
oE-04	[Ai4] End value	0.00 to 100.00 (%)	100.00
oE-05	[Ai4] Start rate	0.0 to [oE-06] (%)	0.0
oE-06	[Ai4] End rate	[oE-05] to 100.0 (%)	100.0
oE-07	[Ai4] Start point selection	00(Start value[oE-03])/ 01(0%)	01
oE-11	[Ai5] Filter time constant	1 to 500 (ms)	16
oE-13	[Ai5] Start value	0.00 to 100.00 (%)	0.00
oE-14	[Ai5] End value	0.00 to 100.00 (%)	100.00
oE-15	[Ai5] Start rate	0.0 to [oE-16] (%)	0.00
oE-16	[Ai5] End rate	[oE-15] to 100.0 (%)	100.0
oE-17	[Ai5] Start point selection	00(Start value[oE-13])/ 01(0%)	01
oE-21	[Ai6] Filter time constant	1 to 500 (ms)	16
oE-23	[Ai6] Start value	-100.00 to 100.00 (%)	-100.00
oE-24	[Ai6] End value		100.00
oE-25	[Ai6] Start rate	-100.0 to [oE-26] (%)	-100.0
oE-26	[Ai6] End rate	[oE-25] to 100.0 (%)	100.0
oE-28	[Ai4] Voltage/Current bias adjustment	-100.00 to 100.00 (%)	0.00

Code No.	Parameter Meaning	Selectable User Setting	Initial value
oE-29	[Ai4] Voltage/Current gain adjustment	0 to 200.00 (%)	100.00
oE-30	[Ai5] Voltage/Current bias adjustment	-100.00 to 100.00 (%)	0.00
oE-31	[Ai5] Voltage/Current gain adjustment	0 to 200.00 (%)	100.00
oE-32	[Ai6] Voltage bias adjustment	-100.00 to 100.00 (%)	0.00
oE-33	[Ai6] Voltage gain adjustment	0 to 200.00 (%)	100.00
oE-35	[Ai4] Window comparator upper limit	0 to 100 (%)	100
oE-36	[Ai4] Window comparator lower limit		0
oE-37	[Ai4] Window comparator hysteresis width	0 to 10 (%)	0
oE-38	[Ai5] Window comparator upper limit	0 to 100 (%)	100
oE-39	[Ai5] Window comparator lower limit		0
oE-40	[Ai5] Window comparator hysteresis width	0 to 10 (%)	0
oE-41	[Ai6] Window comparator upper limit	-100 to 100 (%)	100
oE-42	[Ai6] Window comparator lower limit		-100
oE-43	[Ai6] Window comparator hysteresis width	0 to 10 (%)	0
oE-44	[Ai4] Temporal operation level set at disconnection or compare event	0 to 100 (%)	0
oE-45	[Ai4] Temporal operation level implementation timing	00(Disable)/ 01(Enable(at WC*active))/ 02(Enable(at WC*de-active))	00
oE-46	[Ai5] Temporal operation level set at disconnection or compare event	0 to 100 (%)	0
oE-47	[Ai5] Temporal operation level implementation timing	00(Disable)/ 01(Enable(at WC*active))/ 02(Enable(at WC*de-active))	00
oE-48	[Ai6] Temporal operation level set at disconnection or compare event	-100 to 100 (%)	0
oE-49	[Ai6] Temporal operation level implementation timing	00(Disable)/ 01(Enable(at WC*active))/ 02(Enable(at WC*de-active))	00
oE-50	[Ao3] Output monitor selection		dA-01
oE-51	[Ao4] Output monitor selection	Same as [Cd-03]	dA-01
oE-52	[Ao5] Output monitor selection		dA-01
oE-56	[Ao3] Output filter time constant	1 to 500 (ms)	100
oE-57	[Ao3] Data type selection	00(Absolute value)/ 01(Signed value)	00
oE-58	[Ao3] Bias adjustment (Voltage/Current)	-100.0 to 100.0 (%)	0.0
oE-59	[Ao3] Gain adjustment (Voltage/Current)	-1000.0 to 1000.0 (%)	100.0
oE-60	Adjustment mode [Ao3] output level	-100.0 to 100.0 (%)	100.0
oE-61	[Ao4] Output filter time constant	1 to 500 (ms)	100
oE-62	[Ao4] Data type selection	00(Absolute value)/ 01(Signed value)	00
oE-63	[Ao4] Bias adjustment (Voltage/Current)	-100.0 to 100.0 (%)	0.0
oE-64	[Ao4] Gain adjustment (Voltage/Current)	-1000.0 to 1000.0 (%)	100.0
oE-65	Adjustment mode [Ao4] output level	-100.0 to 100.0 (%)	100.0
oE-66	[Ao5] Output filter time constant	1 to 500 (ms)	100
oE-67	[Ao5] Data type selection	00(Absolute value)/ 01(Signed value)	00
oE-68	[Ao5] Bias adjustment (Voltage)	-100.0 to 100.0 (%)	0.0
oE-69	[Ao5] Gain adjustment (Voltage)	-1000.0 to 1000.0 (%)	100.0
oE-70	Adjustment mode [Ao5] output level	-100.0 to 100.0 (%)	100.0
oH-01	IP-address selection (P1-EN)	00(Group 1)/ 01(Group 2)	00
oH-02	Communication speed (port-1) (P1-EN)	00(Auto Negotiation)/ 01(100M:full duplex)/ 02(100M:half duplex)/ 03(10M:full duplex)/ 04(10M:half duplex)	00
oH-03	Communication speed (port-2) (P1-EN)		00
oH-04	Ethernet communication timeout (P1-EN)	1 to 65535(x10ms)	3000
oH-05	Modbus TCP Port No. (IPv4) (P1-EN)	502, 1024 to 65535	502
oH-06	Modbus TCP Port No. (IPv6) (P1-EN)	502, 1024 to 65535	502
oH-20	PROFIBUS Node address (P1-PB)	0 to 125	0
oH-21	PROFIBUS Clear Mode selection (P1-PB)	00(Clear)/ 01(Keep last value)	00
oH-22	PROFIBUS Map selection (P1-PB)	00(PPO)/ 01(Conventional)/ 02(FlexibleMode)	00
oH-23	PROFIBUS master setting selection (P1-PB)	00(Enable)/ 01(Disable)	00

Code No.	Parameter Meaning	Selectable User Setting	Initial value		
oH-24	PROFIBUS Telegram group selection (P1-PB)	00(Gr.A)/ 01(Gr.B)/ 02(Gr.C)	00		
oH-30	PROFINET IP-Address selection (P1-PN)	00(Group 1)/ 01(Group 2)	00		
oH-31	PROFINET Communication speed (port-1) (P1-PN)	00(Auto Negotiation)/ 01(100M/Full-duplex)/ 02(100M/Half-duplex)/ 03(10M/Full-duplex)/ 04(10M/Half-duplex)	00		
oH-32	PROFINET Communication speed (port-2) (P1-PN)				
oH-33	PROFINET Ethernet communication timeout (P1-PN)	1 to 65535(x10ms)	3000		
oH-34	PROFINET Telegram group selection (P1-PN)	00(Gr.A)/ 01(Gr.B)/ 02(Gr.C)	00		
oH-40	DeviceNet node address (MAC ID) (P1-DN)	0 to 63	0		
oH-41	DeviceNet assembly instance number selection (P1-DN)	00(Instance 20 and 70)/ 01(Instance 21 and 71)/ 02(Instance 100 and 150)/ 03(Instance 101 and 151)/ 04(Instance 101 and 153)/ 05(Instance 110 and 111)/ 06(Instance 123 and 173)/ 07(Instance 139 and 159)	00		
oH-42	DeviceNet speed unit selection (P1-DN)	00(Hz)/ 01(min ⁻¹)	01		
oH-44	DeviceNet flexible Gr. Format selection (P1-DN)	00(Gr. A)/ 01(Gr. B)/ 02(Gr. C)	00		
oH-45	DeviceNet idle mode action selection (P1-DN)	00(Error)/ 01(Trip after Deceleration stop)/ 02(Ignore)/ 03(Free run stop)/ 04(Deceleration stop)	00		
oJ-01 to oJ-10	Writing register 1 to 10, Gr.A	0000 to FFFF	0000		
oJ-11 to oJ-20	Reading register 1 to 10, Gr.A				
oJ-21 to oJ-30	Writing register 1 to 10, Gr.B				
oJ-31 to oJ-40	Reading register 1 to 10, Gr.B				
oJ-41 to oJ-50	Writing register 1 to 10, Gr.C				
oJ-51 to oJ-60	Reading register 1 to 10, Gr.C				
oL-01	IPv4 IP address (1) Gr.1			0 to 255	192
oL-02	IPv4 IP address (2) Gr.1				168
oL-03	IPv4 IP address (3) Gr.1				0
oL-04	IPv4 IP address (4) Gr.1				2
oL-05	IPv4 subnet mask (1) Gr.1	255			
oL-06	IPv4 subnet mask (2) Gr.1	255			
oL-07	IPv4 subnet mask (3) Gr.1	255			
oL-08	IPv4 subnet mask (4) Gr.1	0			
oL-09	IPv4 default gateway (1) Gr.1	192			
oL-10	IPv4 default gateway (2) Gr.1	168			
oL-11	IPv4 default gateway (3) Gr.1	0			
oL-12	IPv4 default gateway (4) Gr.1	1			
oL-20 to oL-27	IPv6 IP address (1) to (8), Gr.1	0000 to FFFF	0000		
oL-28	IPv6 Prefix of subnet, Gr.1	0 to 127	64		
oL-29 to oL-36	IPv6 default gateway (1) to (8), Gr.1	0000 to FFFF	0000		
oL-40	IPv4 IP address (1) Gr.2	0 to 255	192		
oL-41	IPv4 IP address (2) Gr.2		168		
oL-42	IPv4 IP address (3) Gr.2		0		
oL-43	IPv4 IP address (4) Gr.2		2		
oL-44	IPv4 subnet mask (1) Gr.2		255		
oL-45	IPv4 subnet mask (2) Gr.2		255		
oL-46	IPv4 subnet mask (3) Gr.2		255		
oL-47	IPv4 subnet mask (4) Gr.2		0		
oL-48	IPv4 default gateway (1) Gr.2		192		
oL-49	IPv4 default gateway (2) Gr.2		168		
oL-50	IPv4 default gateway (3) Gr.2		0		
oL-51	IPv4 default gateway (4) Gr.2		1		
oL-60 to oL-67	IPv6 IP address (1) to (8), Gr.2	0000 to FFFF	0000		
oL-68	IPv6 Prefix of subnet, Gr.2	0 to 127	64		
oL-69 to oL-76	IPv6 default gateway (1) to (8), Gr.2	0000 to FFFF	0000		

Parameter mode (P code)

Code No.	Parameter Meaning	Selectable User Setting	Initial value
PA-01	Enable Emergency-force drive mode	00(Disable)/ 01(Enable)	00
PA-02	Emergency-force drive frequency reference	0.00 to 590.00 (Hz)	0.00
PA-03	Emergency-force drive direction command	00(Forward)/ 01(Reverse)	00
PA-04	Commercial power supply bypass function selection	00(Disable)/ 01(Enable)	00
PA-05	Commercial power supply bypass function delay time	0.0 to 1000.0 (sec)	5.0
PA-20	Simulation mode enable	00(Disable)/ 01(Enable)	00
PA-21	Error code selection for alarm test	0 to 255 (Error code)	000
PA-22	Simulation mode: Optional output selection for the output current monitor	00(Disable)/ 01(Parameter[PA-23])/ 02(Setting by Terminal[A11])/ 03(Setting by Terminal[A12])/ 04(Setting by Terminal[A13])/ 05(Setting by Terminal[A14])/ 06(Setting by Terminal[A15])/ 07(Setting by Terminal[A16])	01
PA-23	Optional output value setting for the output current monitor	(0 to 3.00) * Inverter rated current	0.0
PA-24	Simulation mode: Optional output selection for the DC bus voltage monitor	00(Disable)/ 01(Parameter[PA-25])/ 02(Setting by Terminal[A11])/ 03(Setting by Terminal[A12])/ 04(Setting by Terminal[A13])/ 05(Setting by Terminal[A14])/ 06(Setting by Terminal[A15])/ 07(Setting by Terminal[A16])	01
PA-25	Optional output value setting for the DC bus voltage monitor	0.0 to 450.0 (Vdc) (200V class) 0.0 to 900.0 (Vdc) (400V class)	(200V class) 270.0 (400V class) 540.0
PA-26	Simulation mode: Optional output selection for the output voltage monitor	00(Disable)/ 01(Parameter[PA-27])/ 02(Setting by Terminal[A11])/ 03(Setting by Terminal[A12])/ 04(Setting by Terminal[A13])/ 05(Setting by Terminal[A14])/ 06(Setting by Terminal[A15])/ 07(Setting by Terminal[A16])	01
PA-27	Optional output value setting for the output voltage monitor	0.0 to 300.0 (V) (200V class) 0.0 to 600.0 (V) (400V class)	0.0
PA-28	Simulation mode: Optional output selection for the output torque monitor	00(Disable)/ 01(Parameter[PA-29])/ 02(Setting by Terminal[A11])/ 03(Setting by Terminal[A12])/ 04(Setting by Terminal[A13])/ 05(Setting by Terminal[A14])/ 06(Setting by Terminal[A15])/ 07(Setting by Terminal[A16])	01
PA-29	Optional output value setting for the output torque monitor	-500.0 to +500.0 (%)	0.0
PA-30	Simulation mode: Optional frequency matching start enable setting	00(Disable)/ 01(Parameter[PA-31])/ 02(Setting by Terminal[A11])/ 03(Setting by Terminal[A12])/ 04(Setting by Terminal[A13])/ 05(Setting by Terminal[A14])/ 06(Setting by Terminal[A15])/ 07(Setting by Terminal[A16])	01
PA-31	Optional frequency matching start setting value	0.00 to 590.00 (Hz)	0.00

Parameter mode (U code)

Code No.	Parameter Meaning	Selectable User Setting	Initial value
UA-01	Password for display	0000 to FFFF	0000
UA-02	Password for softlock		0000
UA-10	Display restriction selection	00(Full display)/ 01(Function-specific display)/ 02(User setting display)/ 03(Data comparison display)/ 04(Monitor only)	00
UA-12	Accumulated input power monitor clear	00(Disable)/ 01(Clear)	00
UA-13	Display gain for the accumulated input power monitor	1 to 1000	1
UA-14	Accumulated output power monitor clear	00(Disable)/ 01(Clear)	00
UA-15	Display gain for the accumulated output power monitor	1 to 1000	1
UA-16	Soft-Lock selection	00(SFT terminal)/ 01(Always enable)	00
UA-17	Soft-Lock target selection	00(All data)/ 01(All, except frequency related values)	00
UA-18	Data R/W selection	00(Enable R/W by operator)/ 01(Disable R/W by operator)	00
UA-19	Low battery warning enable	00(Disable)/ 01(Warning)/ 02(Error)	00
UA-20	Action selection at keypad disconnection	00(Error)/ 01(Error output after deceleration stop)/ 02(Ignore)/ 03(Free run stop)/ 04(Deceleration stop)	02
UA-21	2nd-motor parameter display selection		01
UA-22	Option parameter display selection	00(Hidden)/ 01(Display)	01
UA-30	User-parameter auto setting function enable	00(Disable)/ 01(Enable)	00
UA-31 to UA-62	User-parameter 1 to 32 selection	no**** (select a parameter)	no
UA-90	Waiting time for turning off the display(MOP)	0 to 60 (min)	0
UA-91	Initial display selection (MOP)	no***** (select a monitor parameter)	[dA-01]
UA-92	Enable auto-return to the initial display (MOP)		00
UA-93	Enable frequency changes through monitor display(MOP)	00(Disable)/ 01(Enable)	00
UA-94	Enable multispeed frequency changes through monitor display (MOP)		00
Ub-01	Initialize mode selection	00(Disable)/ 01(Error history clear)/ 02(Data initialize)/ 03(Error history clear & Data initialize)/ 04(Error history clear & Data initialize & EzSQ clear)/ 05(All data except terminal configuration)/ 06(All data except communication configuration)/ 07(All data except terminal & communication configuration)/ 08(EzSQ only)	00
Ub-02	Initialize data selection	00(JP)/ 01(EU)/ 02(USA)/ 03(CHINA)	00(*FF)/ 01(*FEF)/ 02(*FUF)
Ub-03	Load type selection	00(Very Low Duty)/ 01(Low Duty)/ 02(Normal Duty)	02
Ub-05	Enable initialization	00(Disable)/ 01(Execute initialization)	00
UC-01	(-)	(-)	00
Ud-01	Trace function enable	00(Disable)/ 01(Enable)	00
Ud-02	Trace start	00(Stop)/ 01(Start)	00
Ud-03	Number of trace data setting		1
Ud-04	Number of trace signals setting	0 to 8	1
Ud-10 to Ud-17	Trace data 0 to 7 selection	Same as [Cd-03]	[dA-01]
Ud-20	Trace signal 0 input/output selection	00(Input:[Ud-21])/ 01(Output:[Ud-22])	00
Ud-21	Trace signal 0 input terminal selection	Same as [CA-01]	001
Ud-22	Trace signal 0 output terminal selection	Same as [CC-01]	001
Ud-23	Trace signal 1 input/output selection	00(Input:[Ud-24])/ 01(Output:[Ud-25])	00
Ud-24	Trace signal 1 input terminal selection	Same as [CA-01]	001
Ud-25	Trace signal 1 output terminal selection	Same as [CC-01]	001
Ud-26	Trace signal 2 input/output selection	00(Input:[Ud-27])/ 01(Output:[Ud-28])	00
Ud-27	Trace signal 2 input terminal selection	Same as [CA-01]	001
Ud-28	Trace signal 2 output terminal selection	Same as [CC-01]	001
Ud-29	Trace signal 3 input/output selection	00(Input:[Ud-30])/ 01(Output:[Ud-31])	00
Ud-30	Trace signal 3 input terminal selection	Same as [CA-01]	001
Ud-31	Trace signal 3 output terminal selection	Same as [CC-01]	001
Ud-32	Trace signal 4 input/output selection	00(Input:[Ud-33])/ 01(Output:[Ud-34])	00
Ud-33	Trace signal 4 input terminal selection	Same as [CA-01]	001
Ud-34	Trace signal 4 output terminal selection	Same as [CC-01]	001
Ud-35	Trace signal 5 input/output selection	00(Input:[Ud-36])/ 01(Output:[Ud-37])	00

Code No.	Parameter Meaning	Selectable User Setting	Initial value
Ud-36	Trace signal 5 input terminal selection	Same as [CA-01]	001
Ud-37	Trace signal 5 output terminal selection	Same as [CC-01]	001
Ud-38	Trace signal 6 input/output selection	00(Input:[Ud-39])/ 01(Output:[Ud-40])	00
Ud-39	Trace signal 6 input terminal selection	Same as [CA-01]	001
Ud-40	Trace signal 6 output terminal selection	Same as [CC-01]	001
Ud-41	Trace signal 7 input/output selection	00(Input:[Ud-42])/ 01(Output:[Ud-43])	00
Ud-42	Trace signal 7 input terminal selection	Same as [CA-01]	001
Ud-43	Trace signal 7 output terminal selection	Same as [CC-01]	001
Ud-50	Trace trigger 1 selection	00(Trip)/ 01(Data 0)/ 02(Data 1)/ 03(Data 2)/ 04(Data 3)/ 05(Data 4)/ 06(Data 5)/ 07(Data 6)/ 08(Data 7)/ 09(Signal 0)/ 10(Signal 1)/ 11(Signal 2)/ 12(Signal 3)/ 13(Signal 4)/ 14(Signal 5)/ 15(Signal 6)/ 16(Signal 7)	00
Ud-51	Trigger 1 activation selection at trace data trigger	00(Action at rising above the trigger level)/ 01(Action at falling below the trigger level)	00
Ud-52	Trigger 1 level setting at trace data trigger	0 to 100 (%)	0
Ud-53	Trigger 1 activation selection at trace signal trigger	00(Action by signal on)/ 01(Action by signal off)	00
Ud-54	Trace trigger 2 selection	00(Trip)/ 01(Trace data 0)/ 02(Trace data 1)/ 03(Trace data 2)/ 04(Trace data 3)/ 05(Trace data 4)/ 06(Trace data 5)/ 07(Trace data 6)/ 08(Trace data 7)/ 09(Trace signal 0)/ 10(Trace signal 1)/ 11(Trace signal 2)/ 12(Trace signal 3)/ 13(Trace signal 4)/ 14(Trace signal 5)/ 15(Trace signal 6)/ 16(Trace signal 7)	00
Ud-55	Trigger 2 activation selection at trace data trigger	00(Action at rising above the trigger level)/ 01(Action at falling below the trigger level)	00
Ud-56	Trigger 2 level setting at trace data trigger	0 to 100 (%)	0
Ud-57	Trigger 2 activation selection at trace signal trigger	00(Action by signal on)/ 01(Action by signal off)	00
Ud-58	Trigger condition selection	00(At trace trigger 1 activation)/ 01(At trace trigger 2 activation)/ 02(Trigger-1 OR trigger-2 activation)/ 03(Trigger-1 AND trigger-2 activation)	00
Ud-59	Trigger point setting	0 to 100 (%)	0
Ud-60	Sampling time setting	01(0.2ms)/ 02(0.5ms)/ 03(1ms)/ 04(2ms)/ 05(5ms)/ 06(10ms)/ 07(50ms)/ 08(100ms)/ 09(500ms)/ 10(1000ms)	03
UE-01	EzSQ execution cycle	00(1ms)/ 01(2ms: SJ700/L700 compatible)	00
UE-02	EzSQ enable setting	00(Disable)/ 01([PRG] terminal)/ 02(Always enabled)	00
UE-10 to UE-73	EzSQ User parameter U(00) to (63)		0 to 65535
UF-02 to UF-32	EzSQ User parameter UL(00) to (15)		-2147483647 to 2147483647

Input terminal function list

Function code	Symbol	Function name
0	no	Not use
1	FW	Forward rotation
2	RV	Reverse rotation
3 to 6	CF1 to 4	Multi speed selection 1 to 4
7 to 13	SF1 to 7	Multi speed Bit-1 to 7
14	ADD	Trigger for frequency addition
15	SCHG	Main/Sub speed reference change
16	STA	3-wire Start
17	STP	3-wire Stop
18	F/R	3-wire Forward/Reverse
19	AHD	Analog command holding
20	FUP	Remote control Speed-UP function
21	FDN	Remote control Speed-DOWN function
22	UDC	Remote control speed data clearing
23	F-OP	Force operation
24	SET	2nd-motor control
28	RS	Reset
29	JG	Jogging
30	DB	External DC braking
31	2CH	2-stage Acceleration/Deceleration
32	FRS	Free run stop
33	EXT	External fault
34	USP	Unattended start protection
35	CS	Commercial power supply change
36	SFT	Soft-Lock
37	BOK	Answer back from Brake
38	OLR	Overload restriction selection
39	KHC	Accumulation input power clearance
40	OKHC	Accumulation output power clearance
41	PID	Disable PID1
42	PIDC	PID1 integration reset
43	PID2	Disable PID2
44	PIDC2	PID2 integration reset
45	PID3	Disable PID3
46	PIDC3	PID3 integration reset
47	PID4	Disable PID4
48	PIDC4	PID4 integration reset
51 to 54	SVC1 to 4	Multi set-point selection 1 to 4
55	PRO	PID gain change
56	PIO1	PID output switching 1
57	PIO2	PID output switching 2
58	SLEP	SLEEP condition activation
59	WAKE	WAKE condition activation
60	TL	Torque limit enable
61	TRQ1	Torque limit selection bit 1
62	TRQ2	Torque limit selection bit 2
63	PPI	P/PI control mode selection
64	CAS	Control gain change
65	SON	Servo-on
66	FOC	Forcing (Pre-excitation)
67	ATR	Permission of torque control
68	TBS	Torque Bias enable
69	ORT	Home search function
71	LAC	Acceleration/Deceleration cancellation
72	PCLR	Clearance of position deviation
73	STAT	Pulse train position reference input enable
74	PUP	Position bias (ADD)
75	PDN	Position bias (SUB)
76 to 79	CP1 to 4	Multistage position settings selection 1 to 4
80	ORL	Limit signal of Homing function
81	ORG	Start signal of Homing function
82	FOT	Forward Over Travel
83	ROT	Reverse Over Travel
84	SPD	Speed / position switching
85	PSET	Position data presetting
86 to 96	M11 to 11	General-purpose input 1 to 11
97	PCC	Pulse counter clearing
98	ECOM	EzCOM activation
99	PRG	Program RUN
100	HLD	Acceleration/Deceleration disable
101	REN	RUN enable
102	DISP	Display lock
103	PLA	Pulse count A
104	PLB	Pulse count B
105	EMF	Emergency-Force Drive activation
107	COK	Contact check signal
108	DTR	Data trace start
109	PLZ	Pulse train input Z
110	TCH	Teach-in signal

Output terminal function list

Function code	Symbol	Function name
0	no	Not use
1	RUN	Running
2	FA1	Constant-frequency reached
3	FA2	Set frequency overreached
4	FA3	Set frequency reached
5	FA4	Set frequency overreached 2
6	FA5	Set frequency reached
7	IRDY	Inverter ready
8	FWR	Forward rotation
9	RVR	Reverse rotation
10	FREF	Frequency reference = Keypad is selected
11	REF	Run command = Keypad is selected
12	SETM	2nd control is selected
16	OPO	Option output
17	AL	Alarm
18	MJA	Major failure
19	OTQ	Over-torque
20	IP	Instantaneous power failure
21	UV	Undervoltage
22	TRQ	Torque limited
23	IPS	IP-Non stop function is active
24	RNT	Accumulated operation time over
25	ONT	Accumulated power-on time over
26	THM	Electronic thermal alarm (Motor)
27	THC	Electronic thermal alarm (Inverter)
29	WAC	Capacitor life warning
30	WAF	Cooling-fan speed drop
31	FR	RUN command active
32	OHF	Heat sink overheat warning
33	LOC	Low-current indication signal
34	LOC2	Low-current indication signal 2
35	OL	Overload warning notice
36	OL2	Overload warning notice 2
37	BRK	Brake release
38	BER	Brake error
39	CON	Contact control
40	ZS	Zero speed detection
41	DSE	Speed over deviation
42	PDD	Position over deviation
43	POK	Positioning completed
44	PCMP	Pulse count compare match output
45	OD	Over deviation for PID control
46	FBV	PID1 feedback comparison
47	OD2	Over deviation for PID2 control
48	FBV2	PID2 feedback comparison
49	NDc	Communication line disconnection
50	Ai1Dc	Analog [Ai1] disconnection detection
51	Ai2Dc	Analog [Ai2] disconnection detection
52	Ai3Dc	Analog [Ai3] disconnection detection
53	Ai4Dc	Analog [Ai4] disconnection detection
54	Ai5Dc	Analog [Ai5] disconnection detection
55	Ai6Dc	Analog [Ai6] disconnection detection
56 to 61	WCA1 to 6	Window comparator Ai1 to 6
62 to 68	LOG1 to 7	Logical operation result 1 to 7
69 to 75	MO1 to 7	General-purpose output 1 to 7
76	EMFC	Emergency force drive indicator
77	EMBP	Bypass mode indicator
78	WFT	Trace function waiting for trigger
79	TRA	Trace function data logging
80	LBK	Low-battery of keypad
81	OVS	Over-Voltage power supply
84 to 87	AC0 to 3	Alarm code bit-0 to 3
89	OD3	Over deviation for PID3 control
90	FBV3	PID3 feedback comparison
91	OD4	Over deviation for PID4 control
92	FBV4	PID4 feedback comparison
93	SSE	PID soft start error

Wiring and Accessories

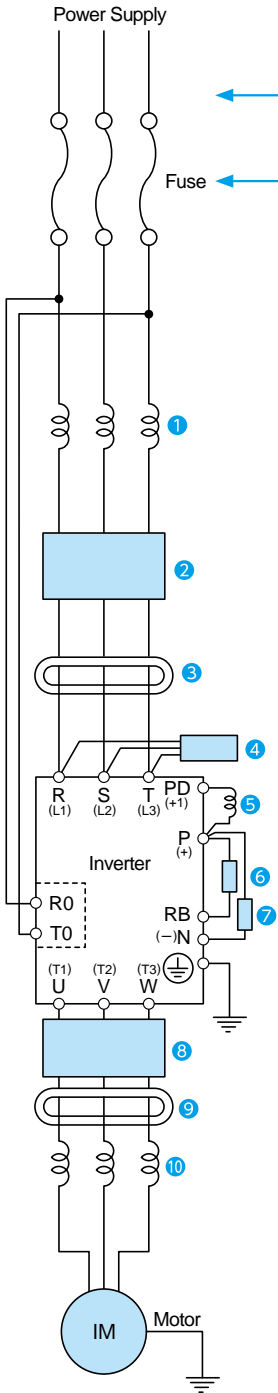

	Name	Function
1	Input side AC reactor	Use input reactor for harmonic wave control, or when power supply voltage imbalance exceeds 3% or more, or when the power supply capacity is over 500 kVA or more, or when the power voltage may change rapidly. This reactor also improves the power factor.
2	EMI filter	This noise filter reduces the conductive noise that is generated by the inverter and transmitted in cables. Connect this noise filter to the primary side (input side) of the inverter.
3	Radio noise filter	The inverter may generate radio noise through power supply wiring during operation. Use this noise filter to reduce the radio noise (radiant noise).
4	Radio noise filter (Capacitor filter)	Use this noise filter to reduce the radiant noise radiated from input cables.
5	DC link choke	Use DC link chokes to reduce the harmonic generated by the inverter. This reactor also improves the power factor.
6	Braking resistor	Use these devices to increase the braking torque of the inverter for operation in which the inverter turns the connected load on and off very frequently or decelerates the load running with a high moment of inertia.
7	Regenerative braking unit	
8	Output side noise filter	Connect this noise filter between the inverter and motor to reduce the radiant noise radiated from cables for the purpose of reducing the electromagnetic interference with radio and television reception and preventing malfunctions of measuring equipment and sensors.
9	Radio noise filter	Use this noise filter to reduce the noise generated on the output side of the inverter. (This noise filter can be used on both the input and output sides.)
10	Output side AC reactor	Inverter driven motor may cause large vibrations compared to commercial power supply direct start motor. Connect Output AC reactor between inverter and motor to lessen the pulsation of motor. Also, connect output AC reactor, when the cable length between inverter and motor is longer (10m or more), to prevent thermal relay malfunction due to the harmonic waves generated by switching operation of inverter. Note that the thermal relay can be replaced with a current sensor to avoid the malfunction.
	LCR filter	Connect this noise filter between the inverter and motor to convert the inverter output into a sinusoidal waveform and to reduce the motor vibration, motor noise and the radiant noise radiated from cables. Surge voltage can be also controlled.

Note: An EMI filter is required for European EMC directive and C-Tick, but the others are not for this purpose.

Option cassette

Three option cassettes can be installed in a SJ series P1 inverter. Please extend according to machine and system specifications.

● Encoder feedback option [P1-FB]

P1-FB successfully detects rotation speed of a motor equipped with an encoder and feedbacks to a SJ series P1 inverter. Thus, it contributes to suppressing the speed variation and helps to operate with high accuracy.

In addition, such function can be realized such as position command, synchronous operation and orientation function.

[Application example]

High precision operation of main motor for Winding machine, Wire drawing machine, Transport machine, Extruder and more.

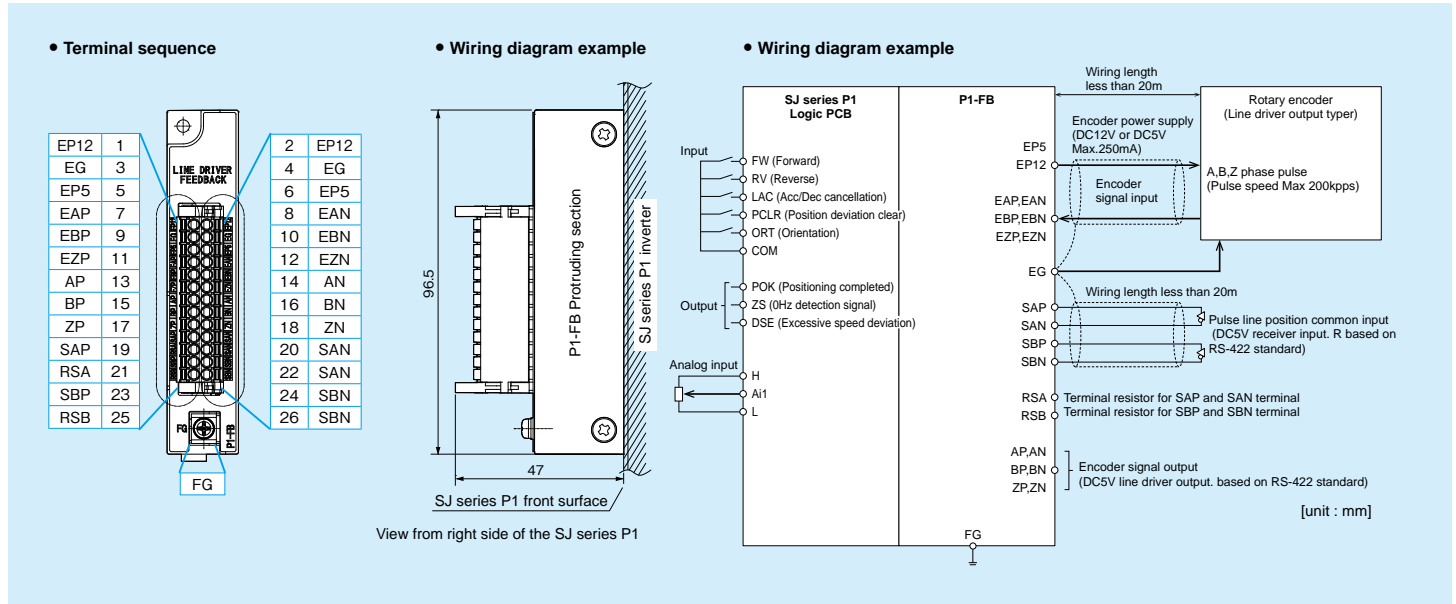

● Analog input/output option P1-AG

P1-AG is an analog input/output expansion unit for a SJ series P1 inverter. This unit have 3 analog inputs and 3 analog outputs allowing a total expansion of 6 analog terminals.

Appearance and Dimensions of protrusion at installation.
[unit : mm]

Item	Specification	
Analog input	-10 to 10 V voltage input: 1 terminal	
	0 to 10 V voltage input: 2 terminals	
	0 to 20 mA current input: 2 terminals	
Analog output	-10 to 10 V voltage output: one terminal	
	0 to 10 V voltage output: 2 terminals 0 to 20 mA current output: 2 terminals	
Analog input/output switch	0 to 10 V voltage/0 to 20 mA current input: 2 terminals 0 to 10 V voltage/0 to 20 mA current output: 2 terminals	
Analog ground common	Reference potential(signal ground): 12 terminals	
Environment	Ambient operating temperature	-10 to 50°C
	Ambient operating humidity	20 to 90%RH
	Storage temperature	-20 to 65°C
	Vibration resistance	5.9 m/s ² (0.6G), 10 to 55 Hz
Conformance to EMC and electrical safety standards	IEC/EN61800-3	No icing or condensation conditions.
	Second environment, Category C3 IEC/EN61800-5-1 SELV	
Enclosure rating	IP00	
Weight	170g (including the packaging)	

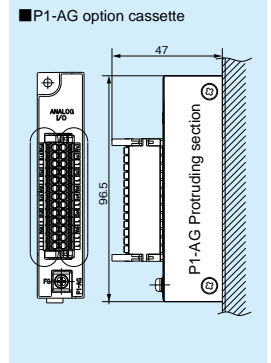

● Safety function option P1-FS

P1-FS is a safety option unit for a SJ series P1 inverter. The P1-FS offers the STO (Safe Torque Off) function, the SS1 (Safe Stop 1) function, the SBC (Safe Brake Control), the SLS (Safely-Limited Speed) function, the SDI (Safe Direction) function, and the SSM (Safe Speed Monitor) function. The applicable standards are EN/ISO 13849-1:CAT.4 PLe, IEC 61800-5-2: SIL3. The parameters for the safety function set to the P1-FS can be configured through the Inverter Configuration Software 'ProDriveNext'.

Appearance and Dimensions of protrusion at installation.
[unit : mm]

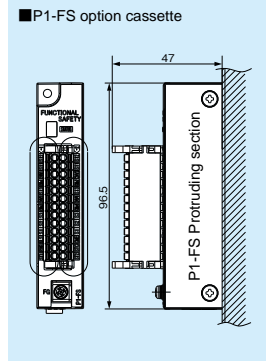

Item		Specification	
Input terminal		Safety input path 1: S1-1, S2-1, S3-1 Safety input path 2: S1-2, S2-2, S3-2 Input current: 6mA Input voltage: DC18V to DC27V	
		Release terminal: RLS Input current: 6mA	
24V output power terminal		DC24V power supply for input terminal: P24E Allowance current: 50mA	
Common for input terminal		CME	
Output terminal		Safety output path 1: S11-1, S12-1, S13-3 Safety output path 2: S11-2, S12-2, S13-4 Output current: 50mA	
		STO output path 1: ST1 STO output path 2: ST2	
24V power supply input terminal for output terminal		Power supply input terminal for S11-1 and S12-1: 24V-1 Power supply input terminal for S11-2 and S12-2: 24V-2 Consumption current: 150mA Input voltage: DC18V to DC27V	
		Power supply input terminal for S13-3: 24V-3 Power supply input terminal for S13-4: 24V-4 Consumption current: 75mA Input voltage: DC18V to DC27V	
Common for output terminal		Common for S11-1 and S12-1: CMo-1 Common for S11-2 and S12-2: CMo-2 Common for S13-3: CMo-3 Common for S13-4: CMo-4 Common for ST1 and ST2: STC	
Safety function	STO (Safe Torque Off)	It is equivalent to stop category 0 defined in EN/IEC60204-1.	
	SS1 (Safe Stop 1)	It is equivalent to stop category 1 defined in EN/IEC60204-1.	
	SBC (Safe Brake Control)	It is output signal to control an external brake unit.	
	SLS (Safely-Limited speed)	It prevents the motor from exceeding the specified speed limit.	
	SDI (Safe Direction)	It prevents the motor shaft from moving in the unintended direction.	
Diagnosis function	SSM (Safe Speed Monitor)	It provides an output signal to indicate whether the motor speed is below a specified limit.	
	Diagnosis function of external path	The P1-FS is equipped with diagnosis function which detects a fault by test pulse in the external safety paths. When an external fault has been detected, the safety paths are maintained shut-off state regardless of the states of the Safety inputs to the P1-FS.	
	Self-diagnosis function of internal path	The P1-FS is equipped with self-diagnosis function which detects a fault in the internal safety paths. When an internal fault has been detected, the safety paths are maintained shut-off state regardless of the states of the Safety inputs to the P1-FS.	
Response time of STO output		10ms max.	
Response time of SBC signal		20ms max.	
Applicable standard	EN ISO/ISO 13849-1	PL e, CAT.4	
	IEC 61508, EN/IEC 61800-5-2, EN/IEC 62061	SIL 3, STO	
Safety-related parameters	PL	e	
	CAT.	4	
	MTTFd	100 years	
	Dcavg	99.60%	
	SIL	3	
	HFT	1	
	SFF	99.90%	
PFH	4.08x10 ⁻¹¹		
Environment	Ambient operating temperature	-10 to 50°C	
	Ambient operating humidity	20 to 90%RH	
	Storage temperature	-20 to 65°C	
	Vibration resistance	5.9m/s ² (0.6G), 10 to 55Hz	
	Location	Altitude 1,000m or less Indoors (No corrosive gasses or dust) : In an enclosure (cabinet) having a protection rating of IP54	
Weight		170g (including the packaging)	

Option cassette

● Field network communication option [P1-ECT, P1-EN, P1-PB, P1-PN, P1-CCL, P1-DN]

With the field network option, the inverter can be operated, status monitor, parameter management etc from the host controller. Since these are cassette type mounted on the front of the inverter, installation, wiring, station number setting and status check of various indicators are very easy.

Item	Specification				
EtherCAT OPTION(P1-ECT)	Communication protocol	EtherCAT CiA402 Drive profile			
	Physical layer	100BASE-TX (IEEE802.3)			
	Connector	RJ45 (IN / OUT)			
	Communication distance	Distance between nodes (between devices) : 100[m]max			
	Station address*1	1 to 99 : Set by the address setting switch, 1 to 65535 : Set by configuration (The station address setting depends on the addressing mode used by the EtherCAT master.)			
	Distributed clock	Free run mode (asynchronous)			
	Process data	PDO free mapping			
	Mailbox (CoE)	Emergency messages, SDO requests, SDO responses, Abort SDO			
	CiA402 drive profile	Velocity mode			
	Applicable cable	100BX-TX support (category 5e or higher) STP(Shield twist pair) cable (Straight or Crossed).			
Ethernet (Modbus-TCP) OPTION(P1-EN)	Applicable standards	IEEE802.3			
	Communication protocol	TCP/IP (Available for IPv4 and IPv6)			
	Communication protocol (application layer)	Modbus TCP			
	Physical layer	10BASE-T, 100BASE-TX (IEEE802.3)			
	Connector	RJ45 (PORT1/PORT2)			
	Communication distance	Distance between nodes (between devices) : 100[m]max			
	Communication method (transmission speed)	Fixed transmission speed : 10Mbps Full/Half-duplex or 100Mbps Full/Half-duplex Auto detection transmission speed : Auto negotiation			
	Auto MDI-X	According to selection of communication method (transmission speed). Selecting the auto negotiation: the function Auto MDI-X is enable. Selecting others: the function Auto MDI-X is disable.			
	Port number	502 (it can be configured by the inverter parameter setting)			
	Maximum number of sessions	4 (Do not connect our Inverter Configuration Software(ProDriveNext) multiple at the same time)			
External power supply	DC24V±10%, Current consumption: 1A to 1.5A (Current consumption fluctuates with inverter and/or other options operating and so on.)				
PROFIBUS OPTION(P1-PB)	Dielectric strength	AC500V (Between insulation circuit)			
	Applicable cable	100BX-TX support (category 5e or higher) STP(Shield twist pair) cable (Straight or Crossed).			
	Communication protocol	PROFIBUS DPV0 PROFIBUS DPV1			
PROFINET OPTION(P1-PN)	Connector, Cable	D-sub 9 pin, PROFIBUS DP cable (EN 50170 part 8-2 as "Cable Type A")			
	Node address	0 to 99 : set by rotary switches 1 to 126 : set by parameters (In case of rotary switch setting is in 0)			
	Profile	PROFdrive			
	Communications protocol	PROFINET IO Ver.2.33			
	Device type	PROFINET IO Device			
	Conformance class	B			
	Protocol	DCP, LLDP, SNMP, MRP			
	Profile	PROFdrive			
	Physical layer	100BASE-TX (IEEE802.3) Auto MDI-X function is supported.			
	Cable	100BX-TX support (category 5e or higher) STP(Shield twist pair) cable (Straight or Crossed).			
CC-Link OPTION(P1-CCL)	Communication speed	Auto negotiation. However, 100BASE-TX full duplex (IEEE802.3) only			
	Communication distance	Distance between nodes (between devices): 100[m]max			
	PROFdrive	PROFdrive version	4.2		
		Application class	AC1 (Standard Drive)		
		Telegram	Standard telegram 1	P1-PN telegram 103 (PPO3 of PROFdrive version 2) P1-PN telegram 104 (PPO4 of PROFdrive version 2) P1-PN telegram 105 (like PPO5 of PROFdrive version 2)	
			Configuring of telegram	oH-24 and From oJ-01 to oJ-60 of SJ series P1 parameters	
	Operating mode	Speed control mode			
	Jogging	Only jogging 1 is supported.			
	Station type	Remote device station			
	Transmission speed	10M / 5M / 2.5M / 625k / 156kbps			
Communication method	Broadcast polling method				
Synchronization method	Frame synchronization				
Encoding method	NRZI				
Topology	Bus (EIA RS485 compatible)				
Transmission format	HDLC compatible				
Error detection code	CRC (X ¹⁶ +X ¹² +X ⁵ +1)				
CC-Link Ver.	Ver.1.00, 1.10				
Extended cyclic setting		Single	Double	Quadruple	Octuple
	Number of link points	RX	32		64
Number of occupied stations	RY	32		64	128
	RWr	4		8	16
	RWw	4		8	16
Transient transmission	Not supported				
Maximum number of connected stations /nodes	Ver.1.00, 1.10	Maximum 64 stations			
	Ver.2.00	Maximum 42 stations only P1-CCL.			
Slave station number	1 to 64				
Connection cable	CC-Link dedicated cable Ver.1.10 CC-Link dedicated high flexible cable Ver.1.10 CC-Link dedicated cable				
Terminating resistor	Selectable with the terminal resistor switch. 110Ω (When above cable is used.) 130Ω (When Ver.1.00 compatible CC-Link dedicated high-performance cable is used.) (Terminal resistor is connected between DA and DB.)				
Profile	Inverter				
DeviceNet OPTION(P1-DN)	Communication Protocol	DeviceNet			
	Device Profile	AC Drive Device Type: 02 Hex			
	Maximum Cable Distance	100m			
	Data Rate	125kbps/250kbps/500kbps (auto detection)			
	Max Connectable Node	Up to 64 nodes (63 nodes as slaves)			
	MAC ID Range	Node Address: 00 to 63 Configuration via rotary switches and/or parameter setting			
	LED	·Module Status LED (MS) ·Network Status LED (NS)			
DeviceNet Communication	Group 2 Only Server (using the Predefined Master/Slave Connection Set)				
Connection Class	·Explicit Message ·Poll				
Common environment specification	Ambient operating temperature, Ambient operating humidity, Storage temperature	-10 to 50°C, 20 to 90%RH, -20 to 65°C (No icing or condensation conditions.)			
	Vibration resistance	5.9m/s ² (0.6G), 10 to 55Hz			
	Conformance to EMC and electrical safety standards	IEC/EN61800-3 Second environment, Category C3 IEC/EN61800-5-1 SELV			
	Enclosure rating	IP00			
	Weight	170g (including the packaging)			

Appearance and Dimensions of protrusion at installation.
[unit : mm]

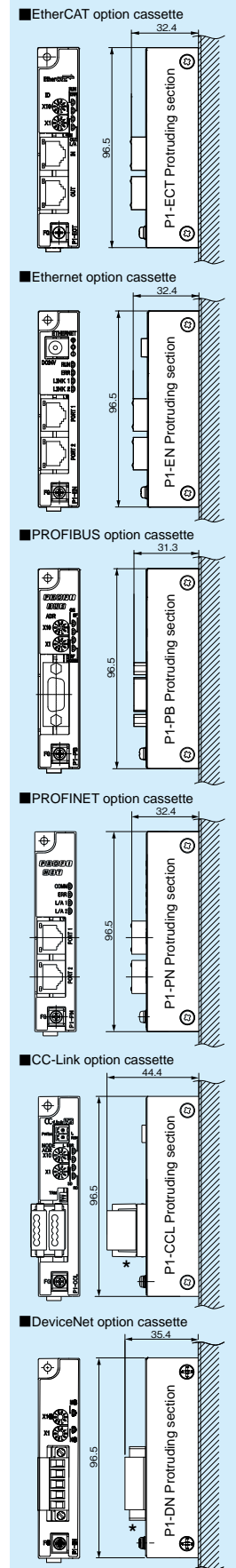

*NOTE: When installing the optional cassette, it protrudes from the P1 surface as shown in the figure. Please design the depth dimension of enclosure considering this protrusion, connector, wiring etc.

Modbus® is a trademark and the property of Schneider Electric SE, its subsidiaries and affiliated companies.

EtherCAT® is registered trademark and patented technology, licensed by Beckhoff Automation GmbH, Germany.

PROFIBUS® and PROFINET® is registered trademark of PROFIBUS Nutzerorganisation e.V. (PNO).

CC-Link® is trade names of Mitsubishi Electric Co. DeviceNet® is the trademark of Open DeviceNet Vendor Association, Inc.

Torque Characteristic

Maximum Torque with Short-time Rating (ND rating)

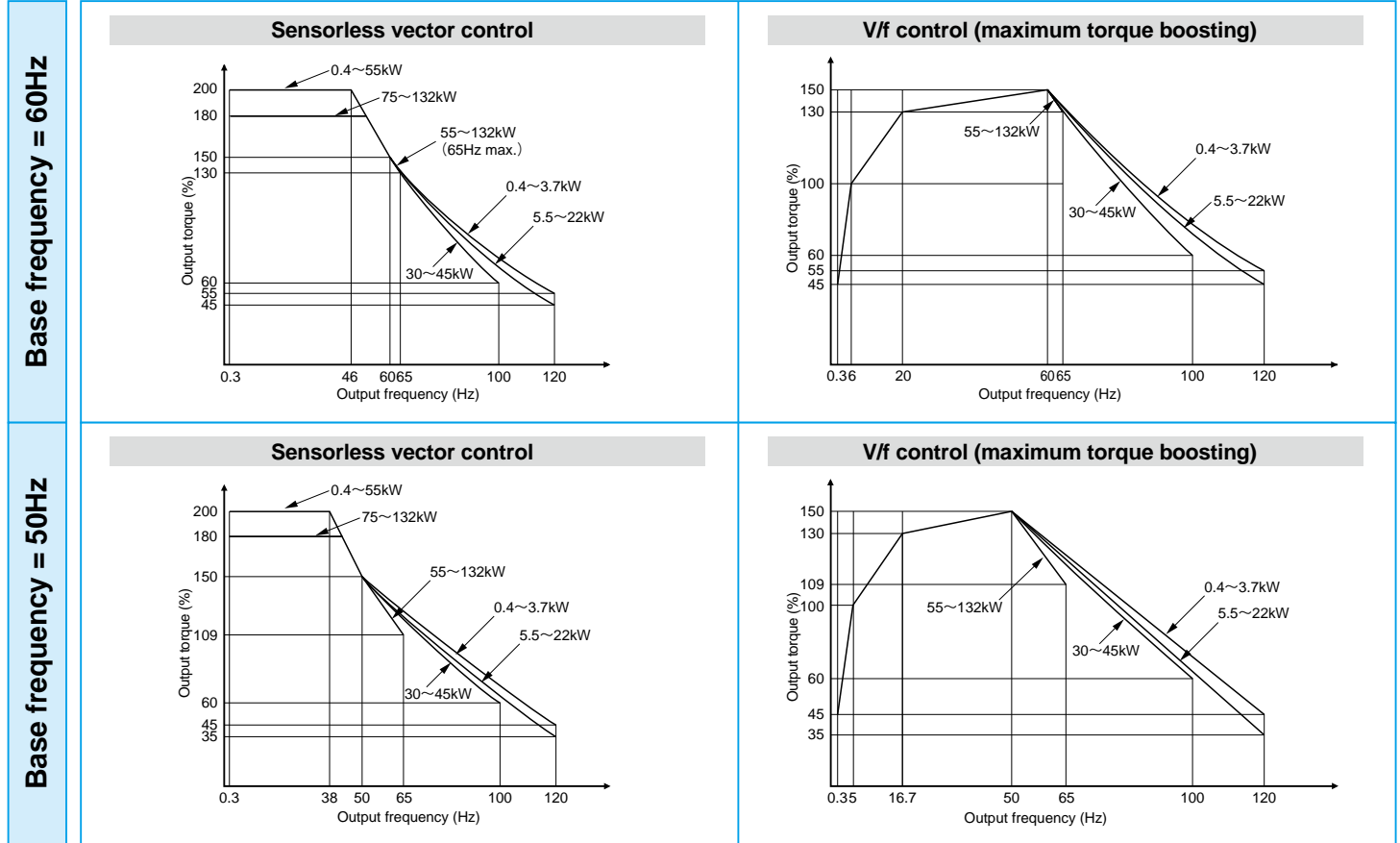

Torque under Continuous Operation (ND rating)

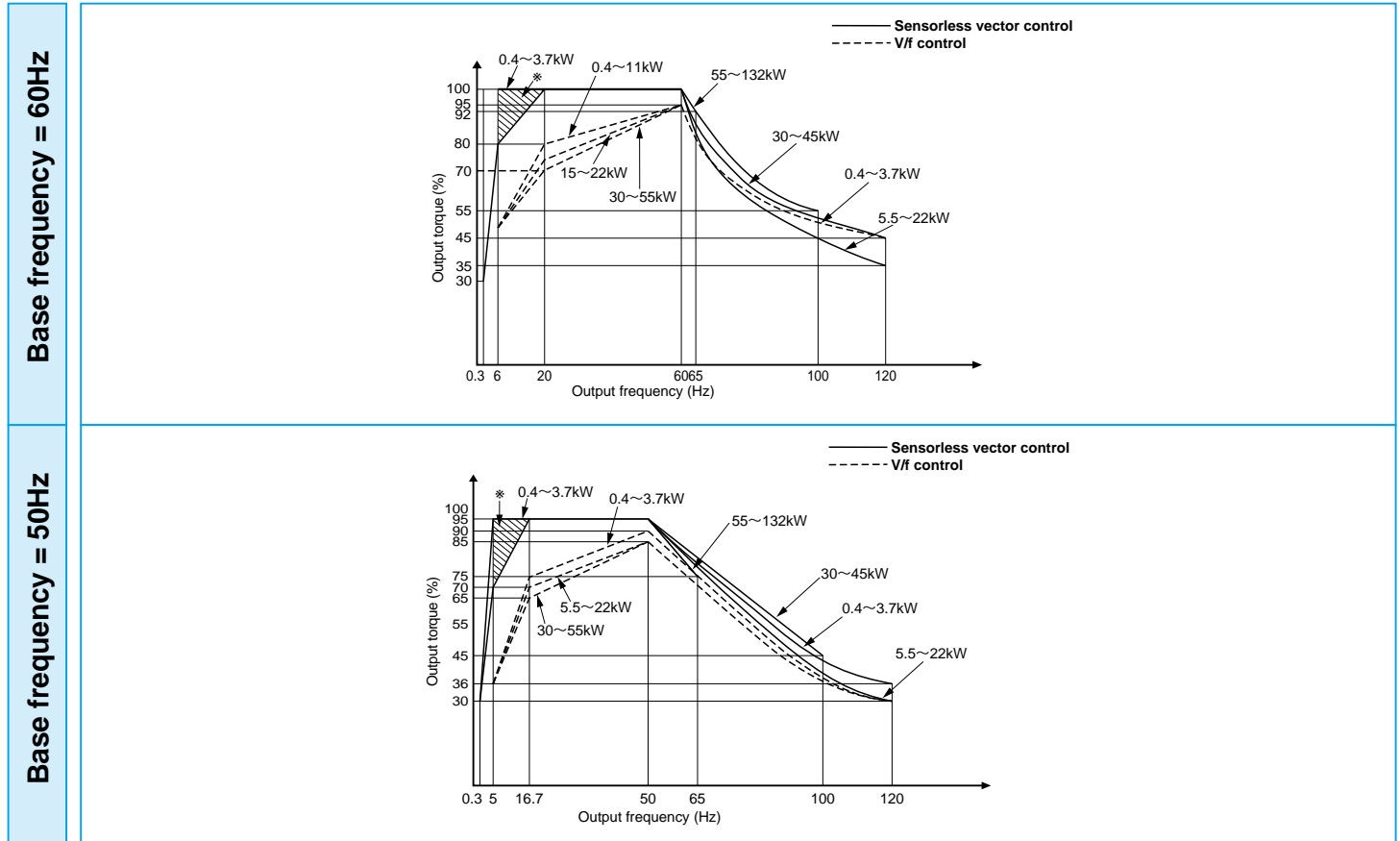

*For motors of 30 kW or more, output torque is 70% under the duty type S3 (Intermittent periodic duty).

Compatibility Between SJ700series and SJ Series P1

Items		SJ700/SJ700D series																							
Control system	IM	V/f control. Sensorless vector control. 0Hz sensorless vector control. Sensorless vector control with encoder.																							
	SM/PMM	None																							
Operator	Display	4digits 7segLED (P1 operator is not usable.)																							
	Copy function	None																							
	Multi language	-																							
	RTC function	None																							
Rated input voltage (V)	200V	200V -15% to 240V +10%																							
	400V	380V -15% to 480V +10%																							
Multi rating	SJ700D: Dual Rating / SJ700: None																								
Mounting dimensions	-																								
Max frequency	V/f	400Hz																							
	Sensorless(IM)	120Hz																							
	Sensorless(PM)	-																							
Option	Number of slots	2 slots																							
	Compatibility	The SJ700 options are only compatible with SJ700 series inverter.																							
Main Circuit Terminals	Screw diameter		Ground terminal screw diameter of SJ700-110L and SJ700-110H(200/400V 11kW,ND) is M5.																						
	Position (mm)(*1)	ND rating code	004	007	015	022	037	055	075	110	150	185	220	300	370	450	550	750	900	1100	1320	1850	2200		
		200V	Upper	60	60	60	60	60	60	60	60	109	109	109	173	101	101	136	/	/	/	/	/	/	/
			Lower	43	43	43	43	43	-	-	-	-	-	-	-	-	-	-	/	/	/	/	/	/	/
400V		Upper	/	60	60	60	60	60	60	60	109	109	109	173	101	101	101	100	100	111	111	/	125	/	
	Lower	/	43	43	43	43	-	-	-	-	-	-	-	-	-	-	-	-	-	-	/	-	/		
Control Circuit Terminals	Screw		M3 screw																						
	Input terminal		FW+8terminals																						
	Relay		1contact(1c)																						
	Frequency setting		3terminals O(Voltage)+OI(Current)+O2(Voltage)																						
	Monitor output		3terminals AM(Voltage)+AMI(Current)+FM(Pulse)																						
	Position (mm)(*1)	ND rating code	004	007	015	022	037	055	075	110	150	185	220	300	370	450	550	750	900	1100	1320	1850	2200		
200V		101	101	101	101	101	106	106	106	210	210	210	313	222	222	297	/	/	/	/	/	/	/		
400V		/	101	101	101	101	106	106	106	210	210	210	313	222	222	222	302	302	425	425	/	341	/		
USB connector		None																							
Functional safety		None																							
Communication	Standard	SJ700D: ASCII/Modbus-RTU Max115.2kbps SJ700: ASCII/Modbus-RTU Max19.2kbps																							
	Terminal resistor	100Ω																							
	Simultaneous usage	No. One of ASCII/Modbus-RTU or option slot communication.																							
	Supported protocols	DeviceNet, CC-Link(Inverter itself is order item for cclink) PROFIBUS-DP																							
Record Number of Trip history		6 times.																							
External 24 VDC control power supply		None.																							
Simulation mode function		None.																							
EzCOM(Communication between INVs)		None.																							
Pulse train input		Available, but feedback option is required.																							
Gain mapping function		None.																							
PID function		1 PID control																							
Multi-stage acceleration/deceleration		None																							
Number of trip retries		3 times																							
Number of EzSQ tasks		SJ700D: 5 tasks / SJ700: 1 task																							

*1: This is the dimension from the bottom of the inverter body including the lower mounting bracket to the center of the terminal screw.

Items		SJ series P1																												
Control system	IM	V/f control. V/f control with encoder.(*2) Sensorless vector control. 0Hz sensorless vector control. Sensorless vector control with encoder.(*2)																												
	SM/PMM	Methods of synchronous startup for vectorless smart control. Methods of IVMS startup for vectorless smart control.(*2)																												
Operator	Display	Color LCD operator (OPE-SBK/WOP for SJ700 is not usable.)																												
	Copy function	Available																												
	Multi language	10 languages (Japanese, English, French, Spanish, Turkish, Polish, Czech, German, Italian, Dutch) (Note:VOP version 2.02 or later)																												
	RTC function	Available (Required a battery prepared by user)																												
Rated input voltage (V)	200V	200V -15% to 240V +10%																												
	400V	380V -15% to 500V +10%																												
Multi rating	Triple rating(*3)																													
Mounting dimensions	Compatible with SJ700(0.4 to 220 kW)																													
Max frequency	V/f	590Hz																												
	Sensorless(IM)	590Hz																												
	Sensorless(PM)	590Hz																												
Option	Number of slots	3 slots																												
	Compatibility	Incompatible with SJ700.																												
Main Circuit Terminals	Screw diameter		Ground terminal screw diameter of P1-00600-L and P1-00310-H(200/400V 11kW,ND) is M6.																											
	Position (mm)(*1)	ND rating code	004	007	015	022	037	055	075	110	150	185	220	300	370	450	550	750	900	1100	1320	1600	1850	2000	2200	2500	3150			
			200V	Upper	60	60	60	60	60	67	67	66	80	80	80	101	101	101	127	/	/	/	/	/	/	/	/	/	/	/
		Lower	43	43	43	43	43	50	50	44	-	-	-	-	-	-	-	/	/	/	/	/	/	/	/	/	/	/		
		400V	Upper	/	45	45	45	45	67	67	66	165	165	165	101	101	101	101	101	101	127	127	132	134	124	124	124	232		
Lower	/	34	34	34	34	50	50	44	142	142	142	-	-	-	-	-	-	-	-	-	-	-	-	-	-	105				
Control Circuit Terminals	Screw		Screw less terminal																											
	Input terminal		11terminals																											
	Relay		2contacts(1a,1c)																											
	Frequency setting		3terminals Ai1/Ai2(Voltage/Current switching)+Ai3(Voltage)																											
	Monitor output		3terminals Ao1/Ao2(Voltage/Current switching)+FM(Pulse)																											
	Position (mm)(*1)	ND rating code	004	007	015	022	037	055	075	110	150	185	220	300	370	450	550	750	900	1100	1320	1600	1850	2000	2200	2500	3150			
200V			98	98	98	98	98	100	100	100	223	223	223	342	330	330	404	/	/	/	/	/	/	/	/	/	/	/		
400V			/	98	98	98	98	100	100	100	223	223	223	342	330	330	330	325	325	444	444	611	611	611	611	611	641			
USB connector	Micro-B(For ProDriveNext)																													
Functional safety	EN ISO/ISO 13849-1 PL e, CAT.4 IEC 61508, EN/IEC 61800-5-2, EN/IEC 62061 SIL 3, STO																													
Communication	Standard	Modbus-RTU Max115.2kbps																												
	Terminal resistor	120Ω																												
	Simultaneous usage	Yes.Modbus-RTU and one of option slot communication are can be used.																												
	Supported protocols	Ethernet(Modbus-TCP), EtherCAT, PROFIBUS-DP PROFINET, CC-Link, DeviceNet																												
Record Number of Trip history	10 times																													
External 24 VDC control power supply	Available																													
Simulation mode function	Available																													
EzCOM(Communication between INVs)	Available																													
Pulse train input	Available as standard until 32kHz.If the Feed back option(P1-FB) is being used it can go up to 200kHz.																													
Gain mapping function	Available																													
PID function	4 PID controls /Soft start function/Sleep function																													
Multi-stage acceleration/deceleration	Available.																													
Number of trip retries	5 times																													
Number of EzSQ tasks	5 Tasks																													

*1: This is the dimension from the bottom of the inverter body including the lower mounting bracket to the center of the terminal screw.

*2: It can be used Ver.2.00 or later inverter.

*3: P1-05500-HFF and P1-06600-HFF are Double rating.

Current Derating

Derating (200V 3.7kW-)

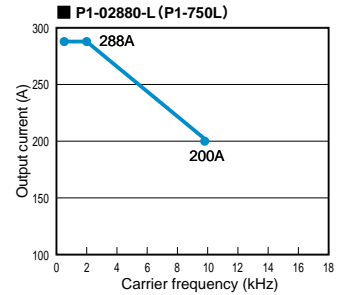
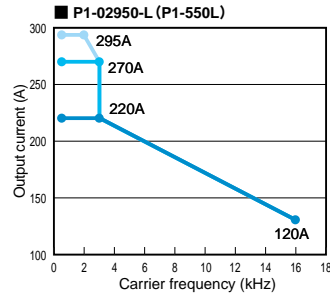
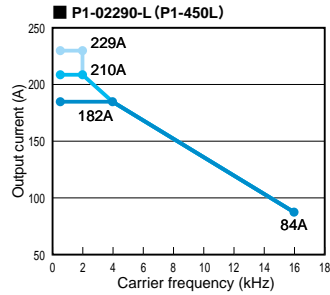
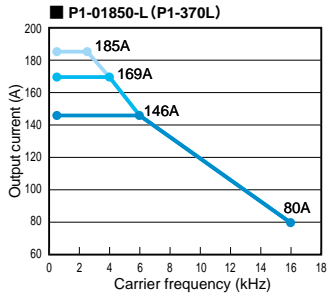
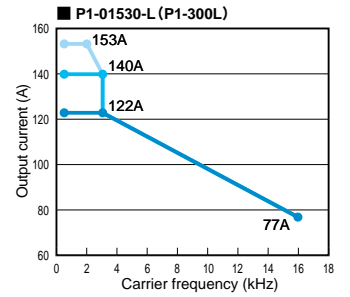
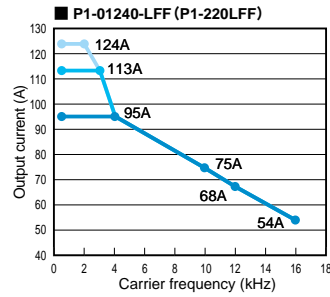
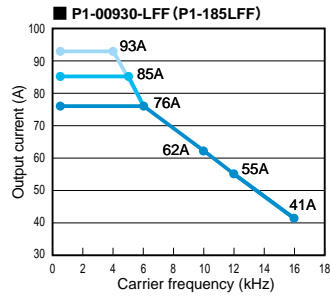
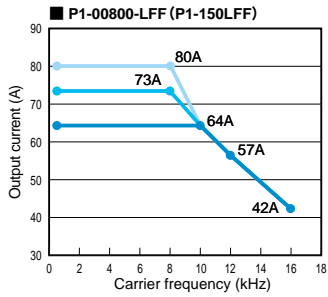
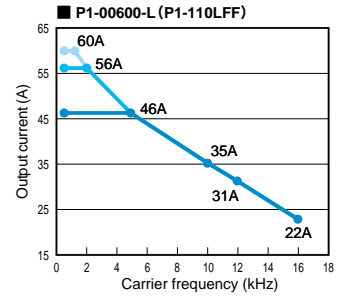
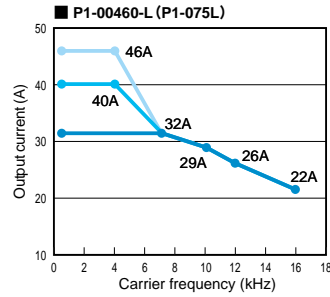
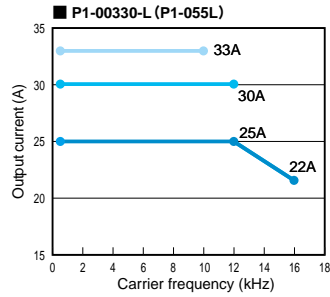
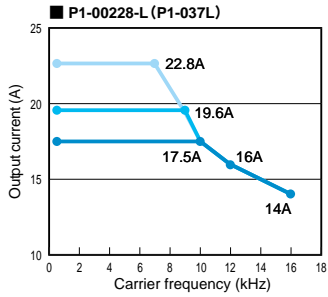

Please use the inverter within the current range in accordance with the derating curves of each model.
Please note that the inverter may be damaged, or its life may be shortened depending on the usage conditions.

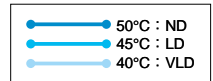

● Derating (400V 0.75kW-)

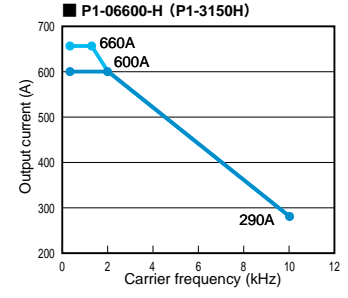
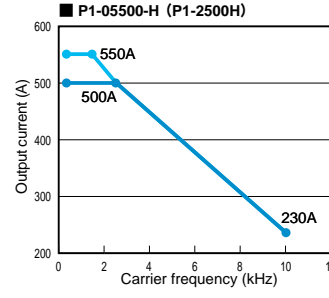
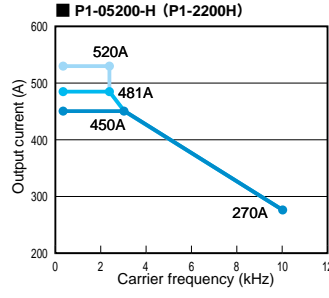
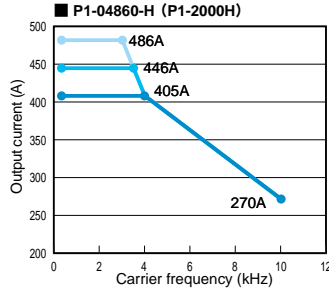
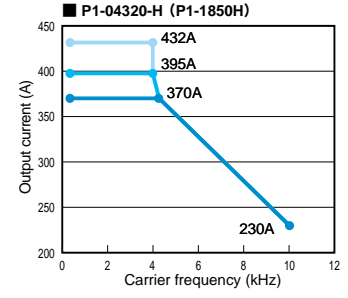
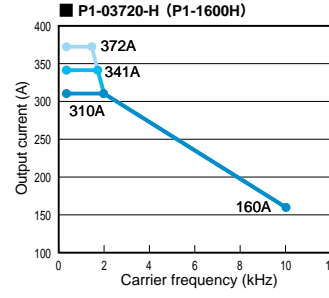
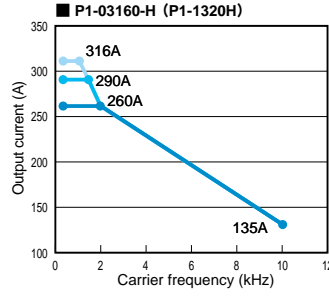
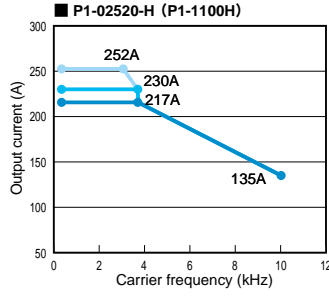
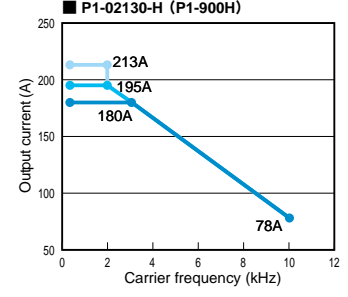
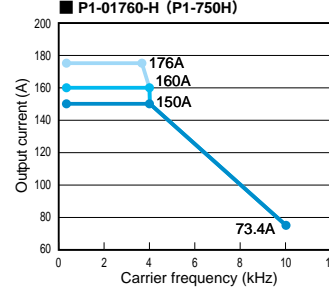
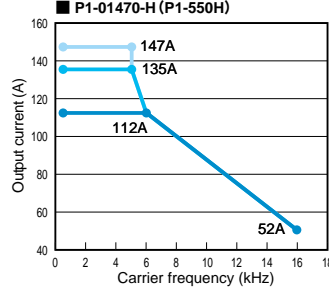
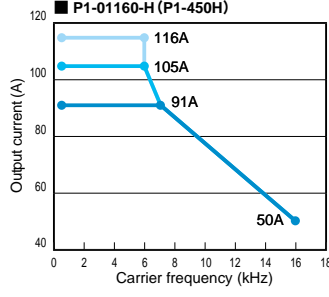
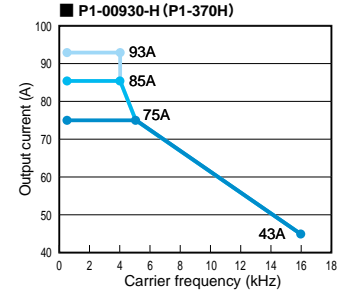
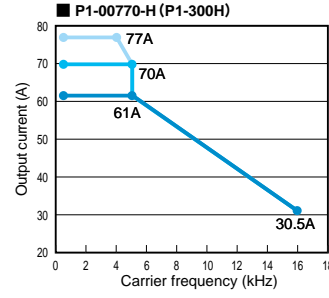
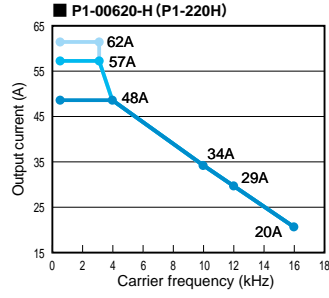
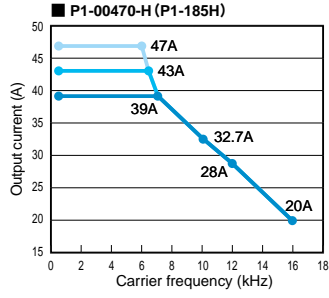
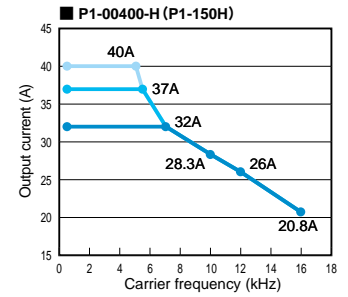
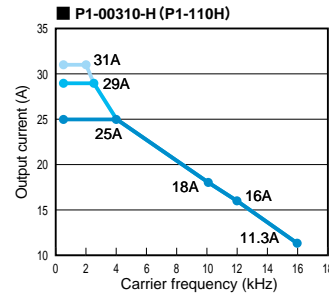
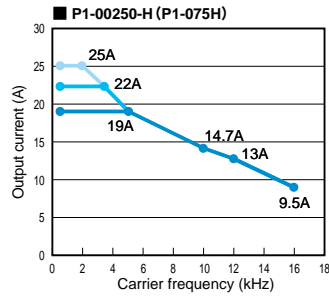
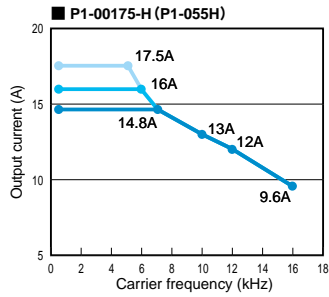
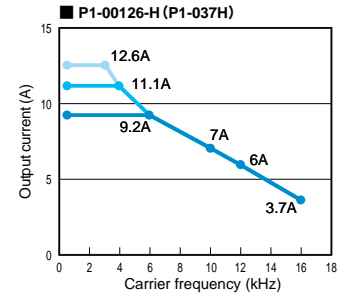
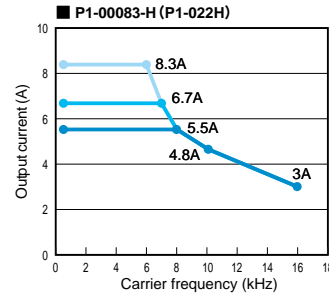
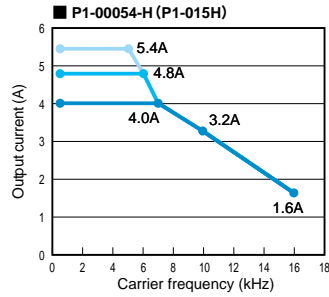
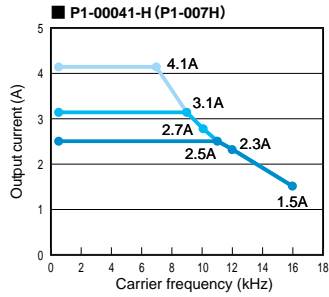

Please use the inverter within the current range in accordance with the derating curves of each model.
Please note that the inverter may be damaged, or its life may be shortened depending on the usage conditions.

Application to Motors

Application to general-purpose motors

Operating frequency	For operation at higher than 60Hz, it is required to examine the allowable torque of the motor, useful life of bearings, noise, vibration, etc. In this case, be sure to consult the motor manufacturer as the maximum allowable rpm differs depending on the motor capacity, etc.
Torque characteristics	The torque characteristics of driving a general-purpose motor with an inverter differ from those of driving it using commercial power (starting torque decreases in particular). Carefully check the load torque characteristic of a connected machine and the driving torque characteristic of the motor.
Motor loss and temperature increase	An inverter-driven general-purpose motor heats up quickly at lower speeds. Consequently, the continuous torque level (output) will decrease at lower motor speeds. Carefully check the torque characteristics vs speed range requirements.
Noise	A general-purpose motor audible noise run by an inverter is slightly greater than it by a commercial power.
Vibration	When run by an inverter at variable speeds, the motor may generate vibration, especially because of (a) unbalance of the rotor including a connected machine, or (b) resonance caused by the natural vibration frequency of a mechanical system. Particularly, be careful of (b) when operating at variable speeds a machine previously fitted with a constant speed motor. Vibration can be minimized by (1) avoiding resonance points using the frequency jump function of the inverter, (2) using a tireshaped coupling, or (3) placing a rubber shock absorber beneath the motor base.
Power transmission mechanism	Under continued, low-speed operation, oil lubrication can deteriorate in a power transmission mechanism with an oil-type gear box (gear motor) or reducer. Check with the motor manufacturer for the permissible range of continuous speed. To operate at more than 60Hz, confirm the machine's ability to withstand the centrifugal force generated.

Application to special motors

Gear motor	The allowable rotation range of continuous drive varies depending on the lubrication method or motor manufacturer. (Particularly in case of oil lubrication, pay attention to the low frequency range.)
Brake-equipped motor	For use of a brake-equipped motor, be sure to connect the braking power supply from the primary side of the inverter.
Pole-change motor	There are different kinds of pole-change motors (constant output characteristic type, constant torque characteristic type, etc.), with different rated current values. In motor selection, check the maximum allowable current for each motor of a different pole count. At the time of pole changing, be sure to stop the motor. Also see: Application to the 400V-class motor.
Submersible motor	The rated current of a submersible motor is significantly larger than that of the general-purpose motor. In inverter selection, be sure to check the rated current of the motor.
Explosion-proof motor	Inverter drive is not suitable for a safety-enhanced explosion-proof type motor. The inverter should be used in combination with a pressure-proof explosion-proof type of motor.
Synchronous (MS) motor High-speed (HFM) motor	In most cases, the synchronous (MS) motor and the high-speed (HFM) motor are designed and manufactured to meet the specifications suitable for a connected machine. As to proper inverter selection, consult the manufacturer.
Single-phase motor	A single-phase motor is not suitable for variable-speed operation by an inverter drive. Therefore, use a three-phase motor.
Permanent magnet motor	Voltage is induced at the motor power terminal during motor rotation even if the inverter power supply is cut off. Therefore, please do not touch the terminals of the motor and inverter during motor rotation. PM motor can not be operated with commercial power supply. In addition, PM motor and inverter are "one to one" combination.

Application to the 400V-class motor

A system applying a voltage-type PWM inverter with IGBT may have surge voltage at the motor terminals resulting from the cable constants including the cable length and the cable laying method. Depending on the surge current magnification, the motor coil insulation may be degraded. In particular, when a 400V-class motor is used, a longer cable is used, and critical loss can occur, take any of the following countermeasures:

- (1) install the LCR filter between the inverter and the motor,
- (2) install the AC reactor between the inverter and the motor, or (3) enhance the insulation of the motor coil.

Notes on Use

Drive

Run/Stop	Run or stop of the inverter must be done with the keys on the operator or through the control circuit terminal. Do not operate by installing a electromagnetic contactor (MC) in the main circuit.
Emergency motor stop	When the protective function is operating or the power supply stops, the motor enters the free run stop state. When an emergency stop is required or when the motor should be kept stopped, use of a mechanical brake should be considered.
High-frequency run	A max. 590Hz can be selected on the SJ Series P1. However, a two-pole motor can attain up to approx. 35,400 rpm, which is extremely dangerous. Therefore, carefully make selection and settings by checking the mechanical strength of the motor and connected machines. Consult the motor manufacturer when it is necessary to drive a standard (general-purpose) motor above 60Hz. High frequency motors are also available in Hitachi.

Repetitive operation on starting or plugging

About frequent repetition use (crane, elevator, press, washing machine), a power semiconductor (IGBT, a rectification diode, thyristor) in the inverter may come to remarkably have a short life by thermal fatigue. The life can be prolonged by lower a load electric current. Lengthen acceleration / deceleration time. Lower carrier frequency. or increasing capacity of the inverter.

Operation use in highlands beyond 1,000m above sea level

Due to the air density decreasing, whenever standard inverters are used for altitudes above 1000m, the following conditions are additionally required for proper operation. In application for operation over 2500m, kindly contact your nearest sales office for assistance.

1. Reduction of inverter rated current
Current rating has to be reduced 1% for every 100m that exceeds from an altitude of 1000m.
For example, for inverters placed at an altitude of 2000m, the rated current has to be reduced 10% (Rated current x0.9) from its original amount.
{(2000m-1000m)/100m*1%=-10%}
2. Reduction of breakdown voltage
Whenever an inverter is used at altitudes beyond 1000m, the breakdown voltage decreases as follows:
1000m or less: 1.00 / 1500m: 0.92 / 2000m: 0.90 / 2500m: 0.85. As mentioned in the instruction manual, please avoid any pressure test.

Installation location and operating environment

Avoid installation in areas of high temperature, excessive humidity, or where moisture can easily collect, as well as areas that are dusty, subject to corrosive gasses, mist of liquid for grinding, or salt. Install the inverter away from direct sunlight in a well-ventilated room that is free of vibration. The inverter can be operated in the ambient temperature range from SJ series P1(ND):-10°C to 50°C, SJ series P1(LD):-10°C to 45°C, SJ series P1(VLD):-10°C to 40°C(When the ambient temperature ranges 40 and 50°C the carrier frequency and the output current must be limited depending on the load type. Please refer to the user's guide)

Main power supply

<p>Installation of an AC reactor on the input side</p>	<p>In the following examples involving a general-purpose inverter, a large peak current flows on the main power supply side, and is able to destroy the converter module. Where such situations are foreseen or the connected equipment must be highly reliable, install an AC reactor between the power supply and the inverter. Also, where influence of indirect lightning strike is possible, install a lightning conductor.</p> <p>(A) The unbalance factor of the power supply is 3% or higher. (Note) (B) The power supply capacity is at least 10 times greater than the inverter capacity (the power supply capacity is 500 kVA or more). (C) Abrupt power supply changes are expected.</p> <p>Examples: (1) Several inverters are interconnected with a short bus. (2) A thyristor converter and an inverter are interconnected with a short bus. (3) An installed phase advance capacitor opens and closes.</p> <p>In cases (A), (B) and (C), it is recommended to install an AC reactor on the main power supply side. Note: Example calculation with $V_{RS} = 205V$, $V_{ST} = 201V$, $V_{TR} = 200V$ V_{RS} : R-S line voltage, V_{ST} : S-T line voltage, V_{TR} : T-R line voltage</p> $\text{Unbalance factor of voltage} = \frac{\text{Max. line voltage (min.)} - \text{Mean line voltage}}{\text{Mean line voltage}} \times 100$ $= \frac{V_{RS} - (V_{RS} + V_{ST} + V_{TR})/3}{(V_{RS} + V_{ST} + V_{TR})/3} \times 100 = \frac{205 - 202}{202} \times 100 = 1.5(\%)$
<p>Using a private power generator</p>	<p>An inverter run by a private power generator may overheat the generator or suffer from a deformed output voltage waveform of the generator. Generally, the generator capacity should be five times that of the inverter (kVA) in a PWM control system, or six times greater in a PAM control system.</p>

Notes on Peripheral Equipment Selection

<p>Wiring connections</p>	<p>(1) Be sure to connect main power wires with R (L1), S (L2), and T (L3) terminals (input) and motor wires to U (T1), V (T2), and W (T3) terminals (output). (Incorrect connection will cause an immediate failure.) (2) Be sure to provide a grounding connection with the ground terminal (⊕).</p>
<p>Wiring between inverter and motor</p>	<p>Electromagnetic contactor When an electromagnetic contactor is installed between the inverter and the motor, do not perform on-off switching during running operation.</p> <p>Thermal relay When an inverter is used with a standard applicable output motor (Hitachi standard three-phase squirrel-cage four-pole motor), a thermal relay for motor protection is not required due to the internal electronic protective circuit. A thermal relay, however, should be used: • during continuous running outside a range of 30 to 60 Hz. • for motors exceeding the range of electronic thermal adjustment (rated current). • when several motors are driven by the same inverter; install a thermal relay for each motor. • The RC value of the thermal relay should be more than 1.1 times the rated current of the motor. If the wiring length is 10 m or more, the thermal relay tends to turn off readily. In this case, provide an AC reactor on the output side or use a current sensor.</p>
<p>Installing a circuit breaker</p>	<p>Install a circuit breaker on the main power input side to protect inverter wiring and ensure personal safety. Choose an inverter-compatible circuit breaker. The conventional type may malfunction due to harmonics from the inverter. For more information, consult the circuit breaker manufacturer.</p>
<p>Wiring distance</p>	<p>The wiring distance between the inverter and the remote operator should be 20 meters or less. Shielded cable should be used on the wiring. Beware of voltage drops on main circuit wires. (A large voltage drop reduces torque.)</p>
<p>Earth leakage relay</p>	<p>If the earth leakage relay (or earth leakage breaker) is used, it should have a sensitivity level of 15 mA or more (per inverter).</p>
<p>Phase advance capacitor</p>	<p>Do not use a capacitor for power factor improvement between the inverter and the motor because the high-frequency components of the inverter output may overheat or damage the capacitor.</p>

High-frequency Noise and Leakage Current

- (1) High-frequency components are included in the input/output of the inverter main circuit, and they may cause interference in a transmitter, radio, or sensor if used near the inverter. The interference can be minimized by attaching noise filters (option) in the inverter circuitry.
- (2) The switching action of an inverter causes an increase in leakage current. Be sure to ground the inverter and the motor.

Lifetime of Primary Parts

Because a DC bus capacitor deteriorates as it undergoes internal chemical reaction, it should normally be replaced every 10 years. Be aware, however, that its life expectancy is considerably shorter when the inverter is subjected to such adverse factors as high temperatures or heavy loads exceeding the rated current of the inverter. The approximate lifetime of the capacitor is as shown in the figure at the right when it is used 24 hours daily (80% load). JEMA standard is the 5 years at ambient temperature 40°C used in 12 hours daily. (According to the "Instructions for Periodic Inspection of General-Purpose Inverter" (JEMA).) Also, such moving parts as a cooling fan should be replaced. Maintenance inspection and parts replacement must be performed by only specified trained personnel. Please plan to replace new inverter depends on the load, ambient condition in advance.

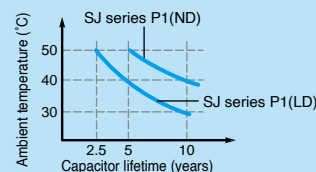

Precaution for Correct Usage

- Before use, be sure to read through the Instruction Manual to insure proper use of the inverter.
- Note that the inverter requires electrical wiring; a trained specialist should carry out the wiring.
- The inverter in this catalog is designed for general industrial applications. For special applications in fields such as aircraft, outer space, nuclear power, electrical power, transport vehicles, clinics, and underwater equipment, please consult with us in advance.
- For application in a facility where human life is involved or serious injury may occur, make sure to provide safety devices to avoid any accident.
- The inverter is intended for use with a three-phase AC motor. For use with a load other than this, please consult with us.

