

IGBT MODULE (U series) 600V / 50A / PIM



■ Features

- Low $V_{CE(sat)}$
- Compact Package
- P.C. Board Mount Module
- Converter Diode Bridge Dynamic Brake Circuit

■ Applications

- Inverter for Motoe Drive
- AC and DC Servo Drive Amplifier
- Uninterruptible Power Supply

■ Maximum ratings and characteristics

● Absolute maximum ratings ($T_c=25^{\circ}\text{C}$ unless otherwise specified)

Item	Symbol	Condition	Rating	Unit	
Inverter	Collector-Emitter voltage	V_{CES}	600	V	
	Gate-Emitter voltage	V_{GES}	± 20	V	
	Collector current	I_C	Continuous	50	A
		I_{CP}	1ms	100	
		$-I_C$		50	
		$-I_C$ pulse	1ms	100	
Collector power dissipation	P_C	1 device	187	W	
Brake	Collector-Emitter voltage	V_{CES}	600	V	
	Gate-Emitter voltage	V_{GES}	± 20	V	
	Collector current	I_C	Continuous	20	A
		I_{CP}	1ms	40	A
	Collector power dissipation	P_C	1 device	104	W
	Repetitive peak reverse voltage	V_{RRM}		600	V
Converter	Repetitive peak reverse voltage	V_{RRM}	800	V	
	Average output current	I_o	50Hz/60Hz sine wave	50	A
	Surge current (Non-Repetitive)	I_{FSM}	$T_j=150^{\circ}\text{C}$, 10ms	350	A
	I^2t (Non-Repetitive)	I^2t	half sine wave	613	A^2s
Operating junction temperature	T_j		+150	$^{\circ}\text{C}$	
Storage temperature	T_{stg}		-40 to +125	$^{\circ}\text{C}$	
Isolation voltage	V_{iso}	AC : 1 minute	between terminal and copper base *2	AC 2500	V
			between thermistor and others *3	AC 2500	
Mounting screw torque			3.5 *1	N·m	

*1 Recommendable value : 2.5 to 3.5 N·m (M5)

*2 All terminals should be connected together when isolation test will be done.

*3 Two thermistor terminals should be connected together, each other terminals should be connected together and shorted to base plate when isolation test will be done.

● Electrical characteristics (T_j=25°C unless otherwise specified)

Item	Symbol	Condition	Characteristics			Unit		
			Min.	Typ.	Max.			
Inverter	Zero gate voltage collector current	ICES	V _{CE} =600V, V _{GE} =0V		-	1.0	mA	
	Gate-Emitter leakage current	IGES	V _{CE} =0V, V _{GE} =±20V		-	200	nA	
	Gate-Emitter threshold voltage	V _{GE(th)}	V _{CE} =20V, I _C =50mA		6.2	6.7	7.7	V
	Collector-Emitter saturation voltage	V _{CE(sat)} (terminal)	V _{GE} =15V I _C =50A	T _J =25°C	-	2.25	2.55	V
				T _J =125°C	-	2.45	-	
		V _{CE(sat)} (chip)		T _J =25°C	-	1.85	-	
				T _J =125°C	-	2.15	-	
	Input capacitance	C _{ies}	V _{GE} =0V, V _{CE} =10V, f=1MHz		-	3.6	-	nF
	Turn-on time	t _{on}	V _{CC} =300V		-	0.42	1.20	μs
		t _r	I _C =50A		-	0.24	0.60	
		t _{r(i)}	V _{GE} =±15V		-	0.05	-	
	Turn-off time	t _{off}	R _G =68Ω		-	0.42	1.20	μs
t _f				-	0.03	0.45		
Forward on voltage	V _F (terminal)	V _{GE} =0V I _F =50A	T _J =25°C	-	2.00	2.35	V	
			T _J =125°C	-	2.05	-		
	V _F (chip)		T _J =25°C	-	1.60	-		
			T _J =125°C	-	1.65	-		
Reverse recovery time	t _{rr}	I _F =50A		-	-	0.35	μs	
Brake	Zero gate voltage collector current	ICES	V _{CE} =600V, V _{GE} =0V		-	1.0	mA	
	Gate-Emitter leakage current	IGES	V _{CE} =0V, V _{GE} =±20V		-	200	nA	
	Collector-Emitter saturation voltage	V _{CE(sat)} (terminal)	I _C =20A V _{GE} =15V	T _J =25°C	-	1.85	2.15	V
				T _J =125°C	-	2.15	-	
		V _{CE(sat)} (chip)		T _J =25°C	-	1.70	-	
				T _J =125°C	-	2.00	-	
	Turn-on time	t _{on}	V _{CC} =300V		-	0.45	1.20	μs
		t _r	I _C =20A		-	0.15	0.60	
	Turn-off time	t _{off}	V _{GE} =±15V		-	0.37	1.20	μs
		t _f	R _G =270Ω		-	0.04	0.45	
	Reverse current	I _{RRM}	V _R =600V		-	-	1.0	mA
	Converter	Forward on voltage	V _{FM}	I _F =50A	terminal	-	1.20	1.50
V _{GE} =0V				chip	-	1.10	-	
Reverse current	I _{RRM}	V _R =800V		-	-	1.0	mA	
Thermistor	Resistance	R	T=25°C	-	5000	-	Ω	
			T=100°C	465	495	520		
B value	B	T=25/50°C		3305	3375	3450	K	

● Thermal resistance Characteristics

Item	Symbol	Condition	Characteristics			Unit
			Min.	Typ.	Max.	
Thermal resistance (1 device)	R _{th(j-c)}	Inverter IGBT	-	-	0.67	°C/W
		Inverter FWD	-	-	1.10	
		Brake IGBT	-	-	1.20	
		Converter Diode	-	-	0.82	
Contact thermal resistance *	R _{th(c-f)}	With thermal compound	-	0.05	-	

* This is the value which is defined mounting on the additional cooling fin with thermal compound

■ Equivalent Circuit Schematic

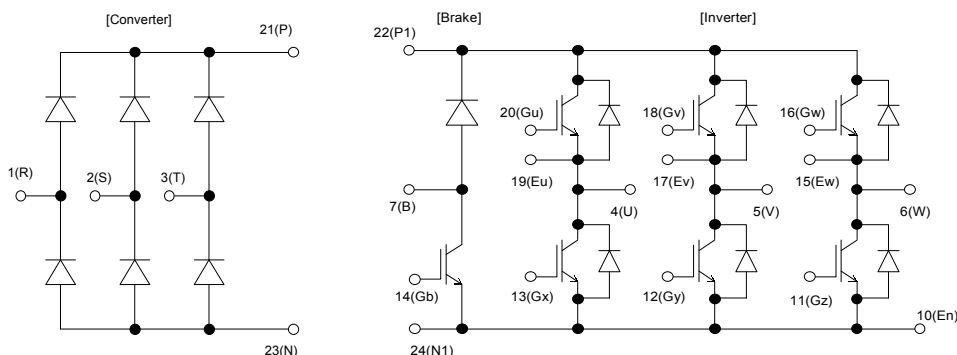

■ Characteristics (Representative)

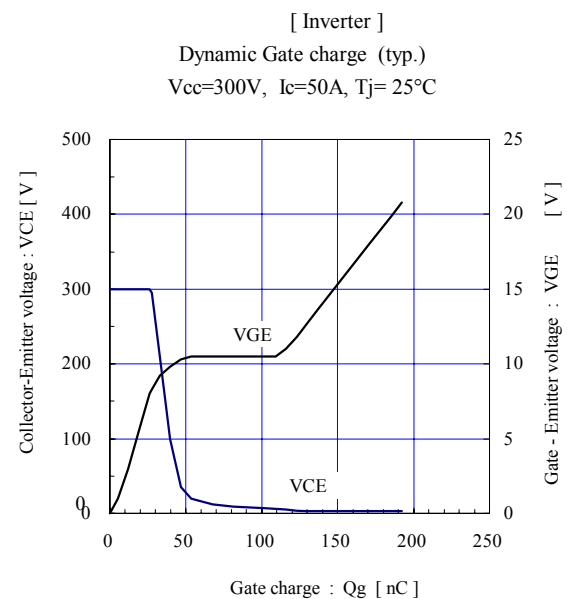
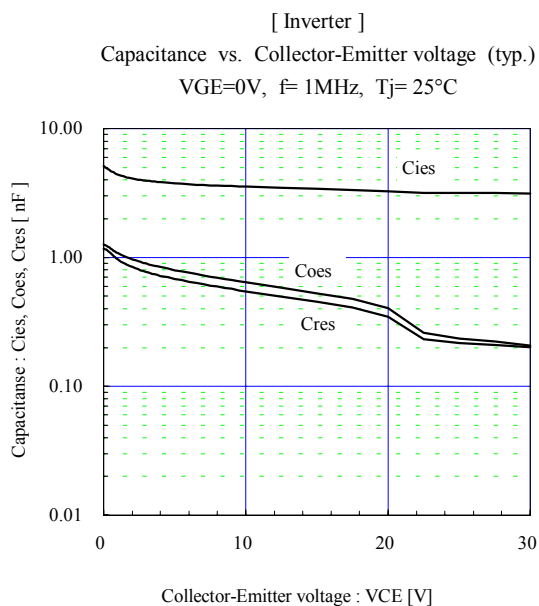
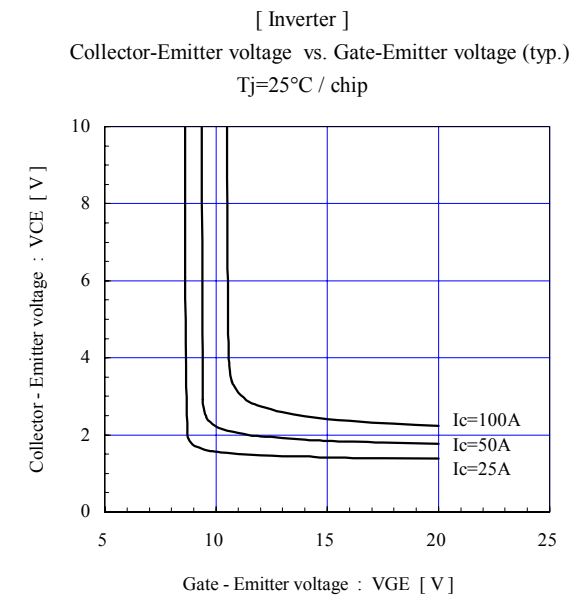
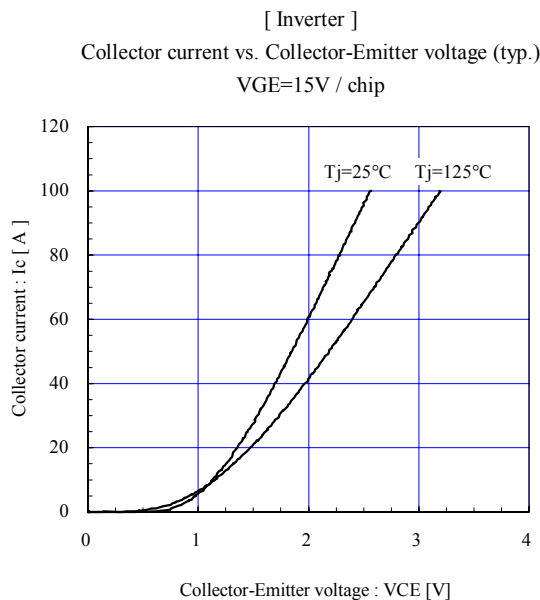
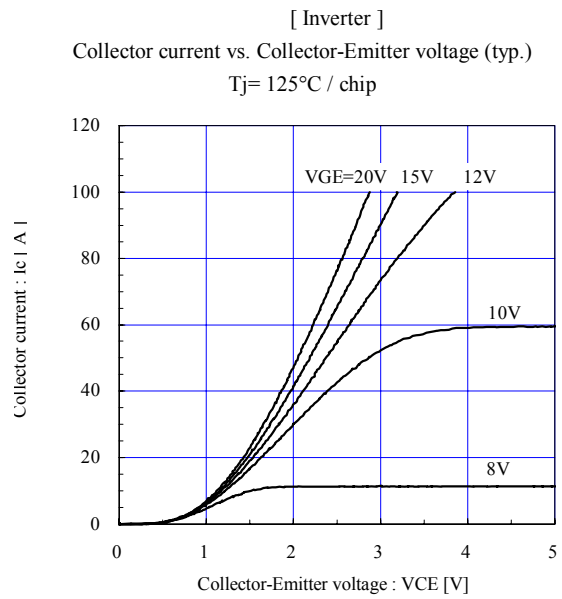
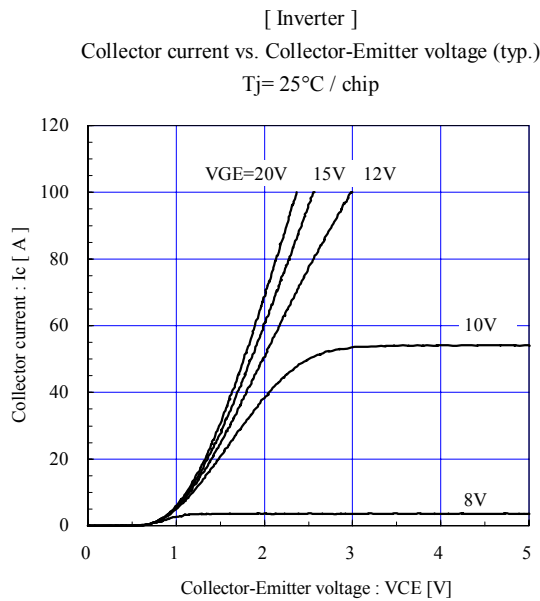

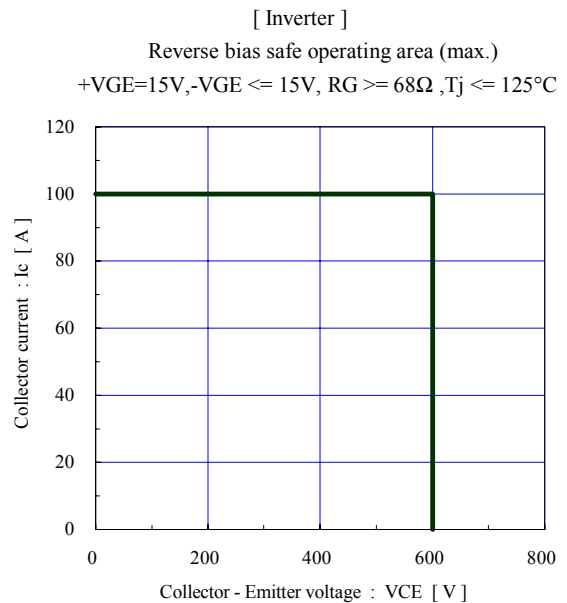
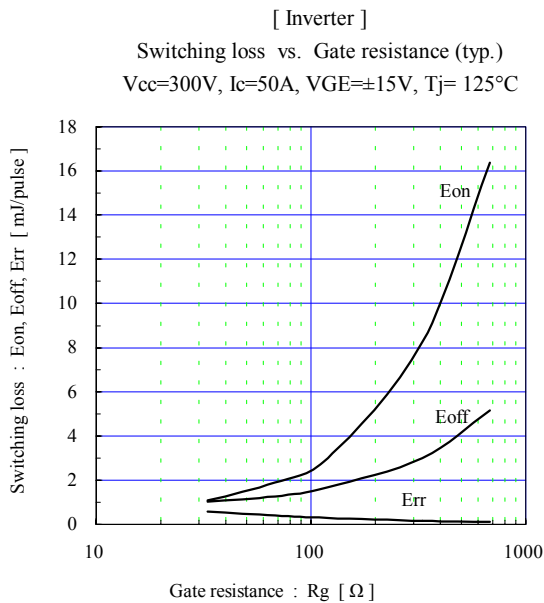
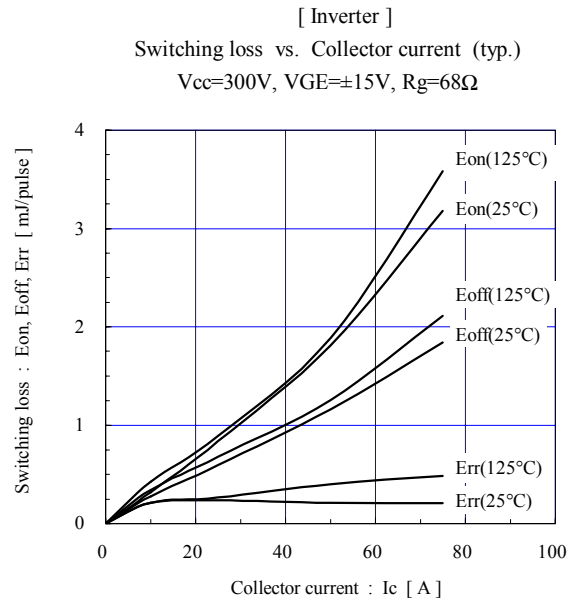
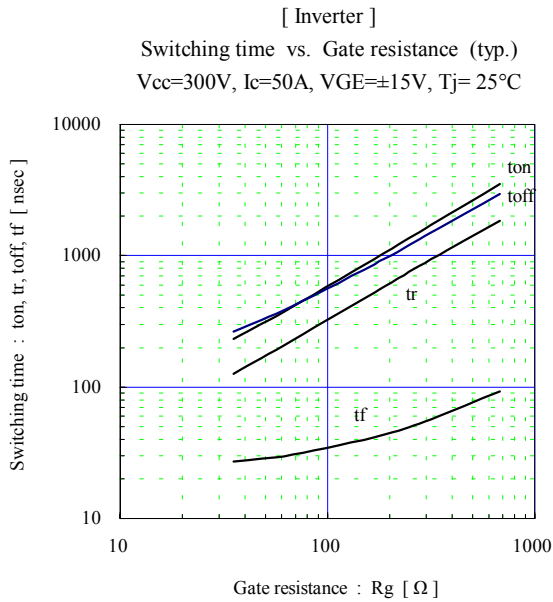
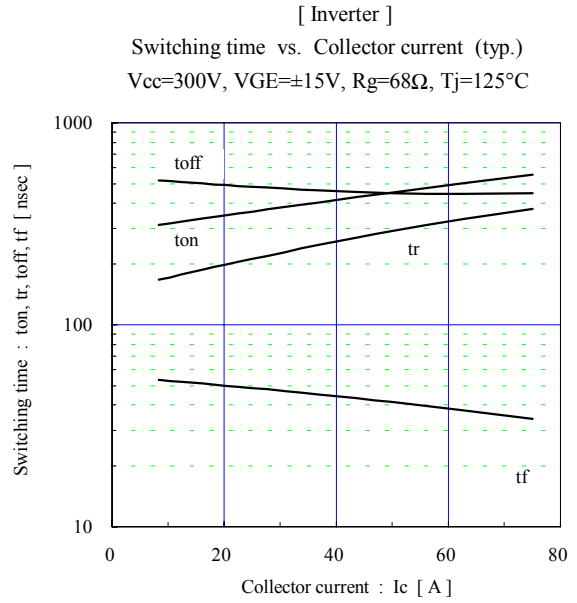
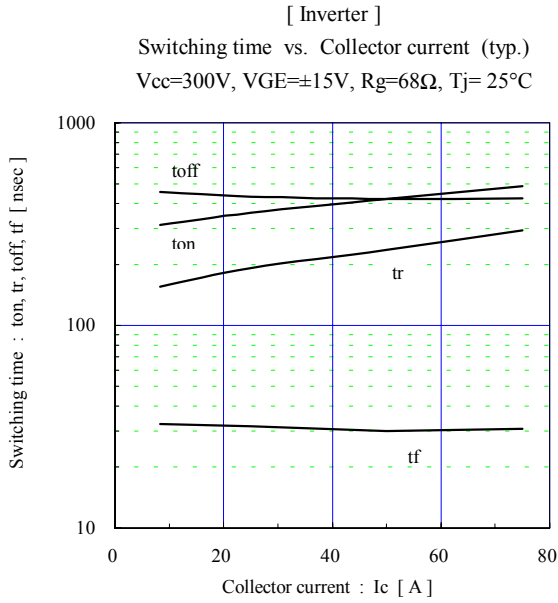

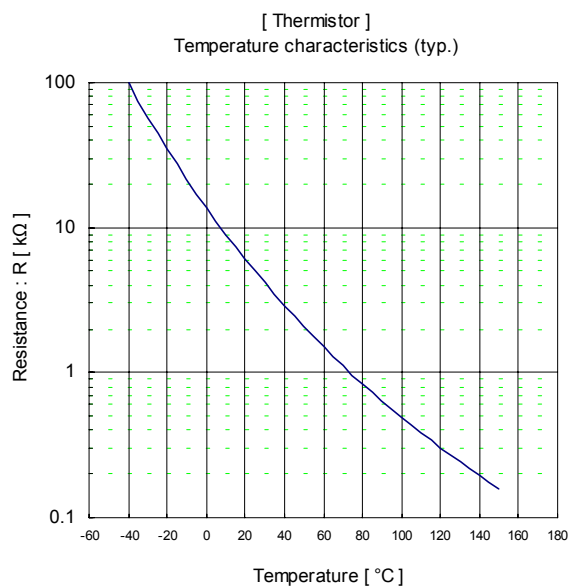
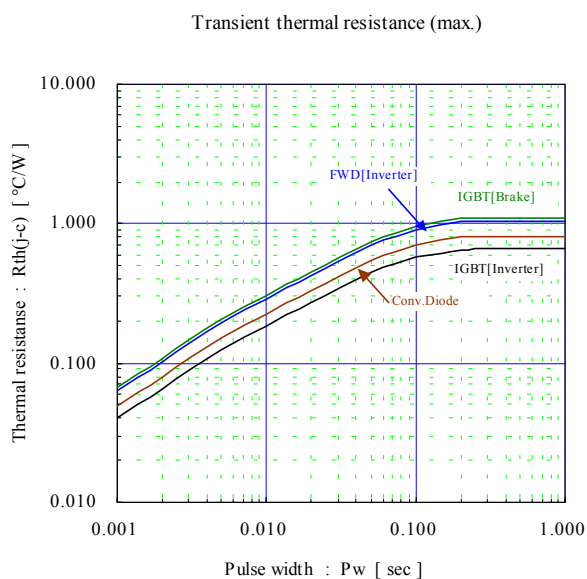
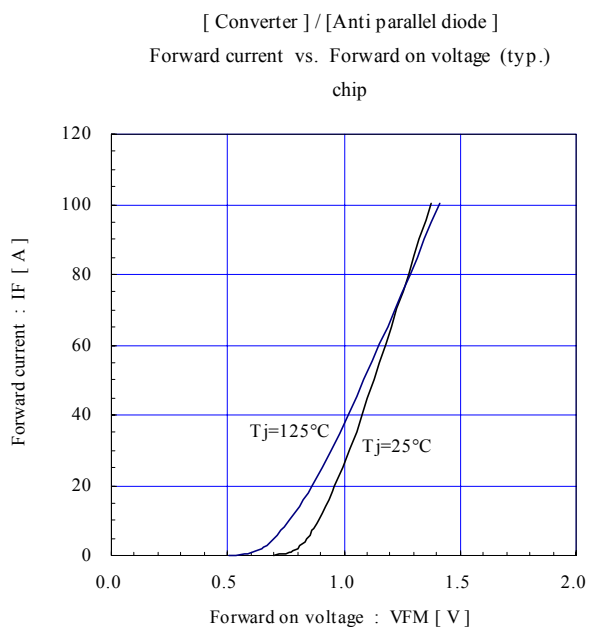
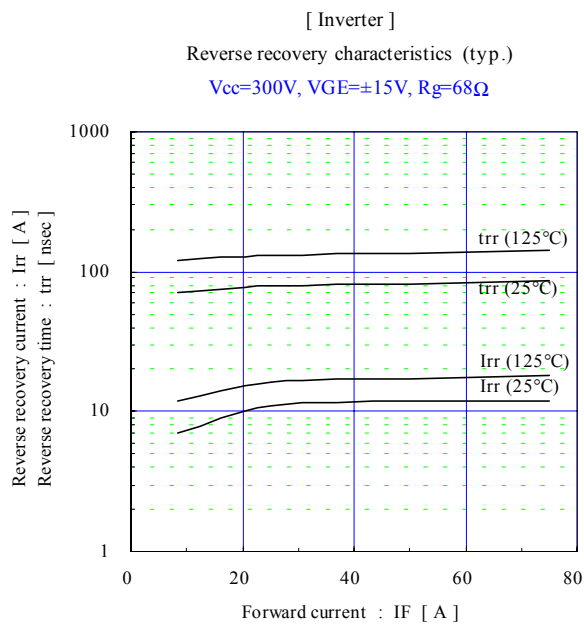
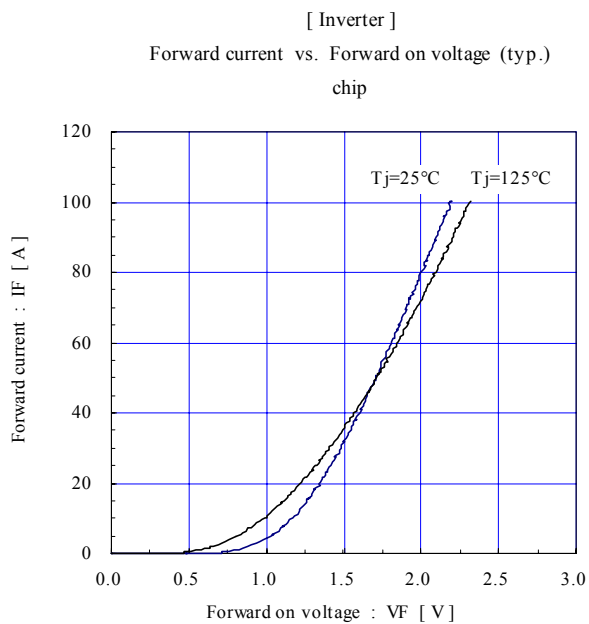

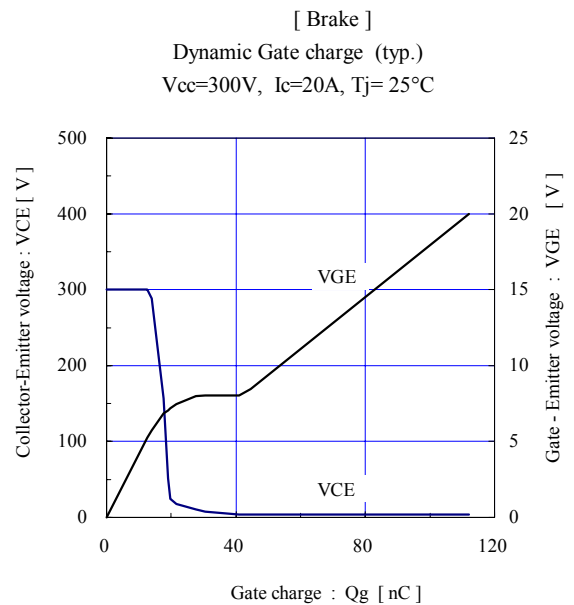
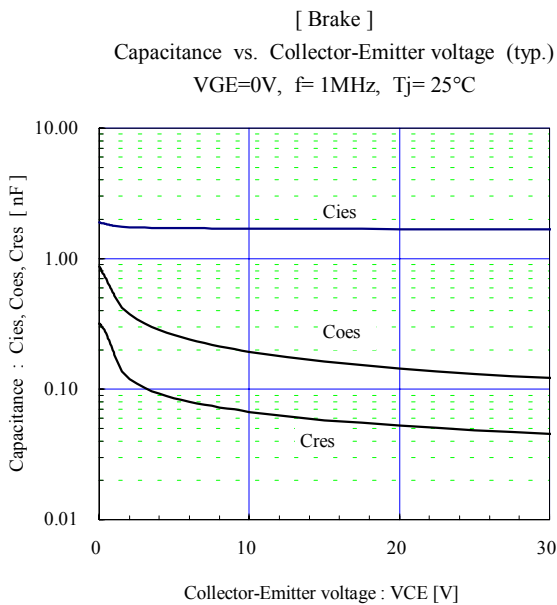
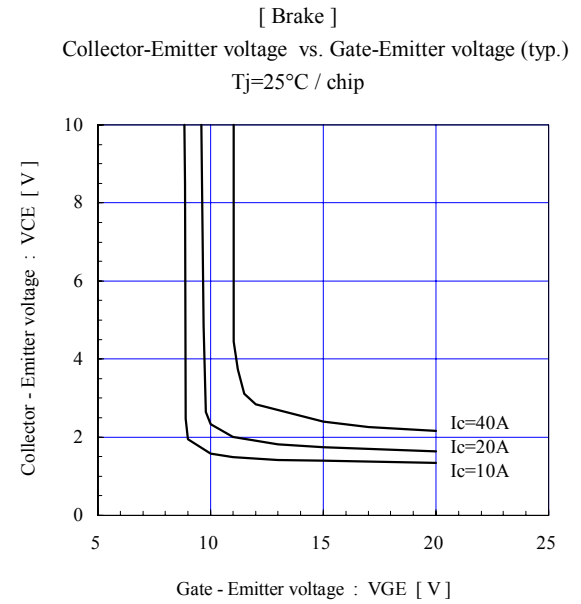
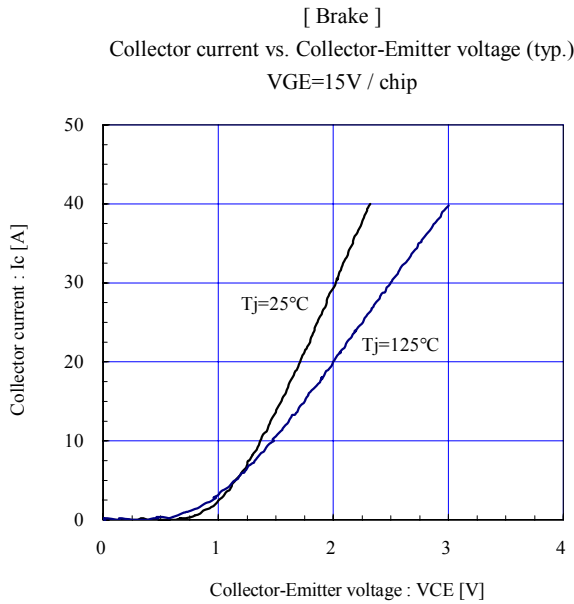
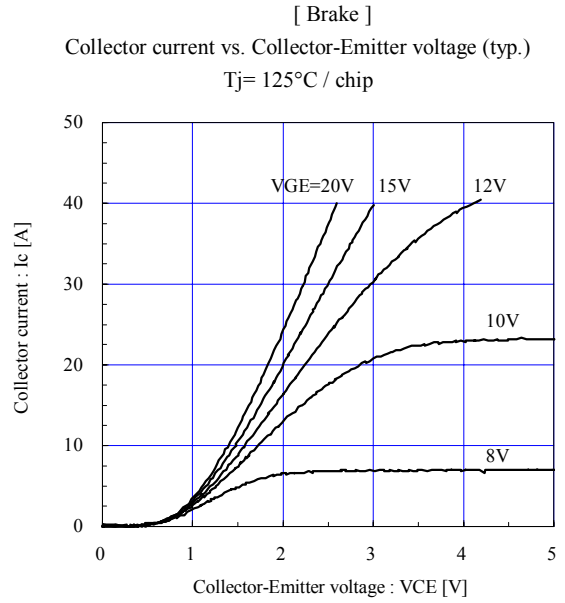
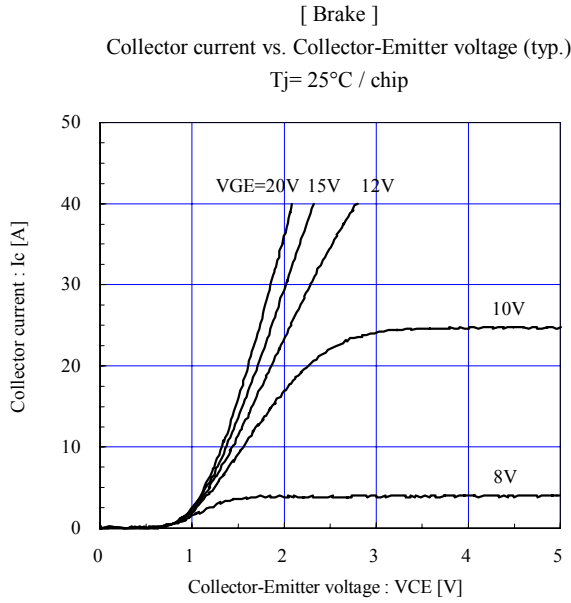

■ Outline Drawings, mm

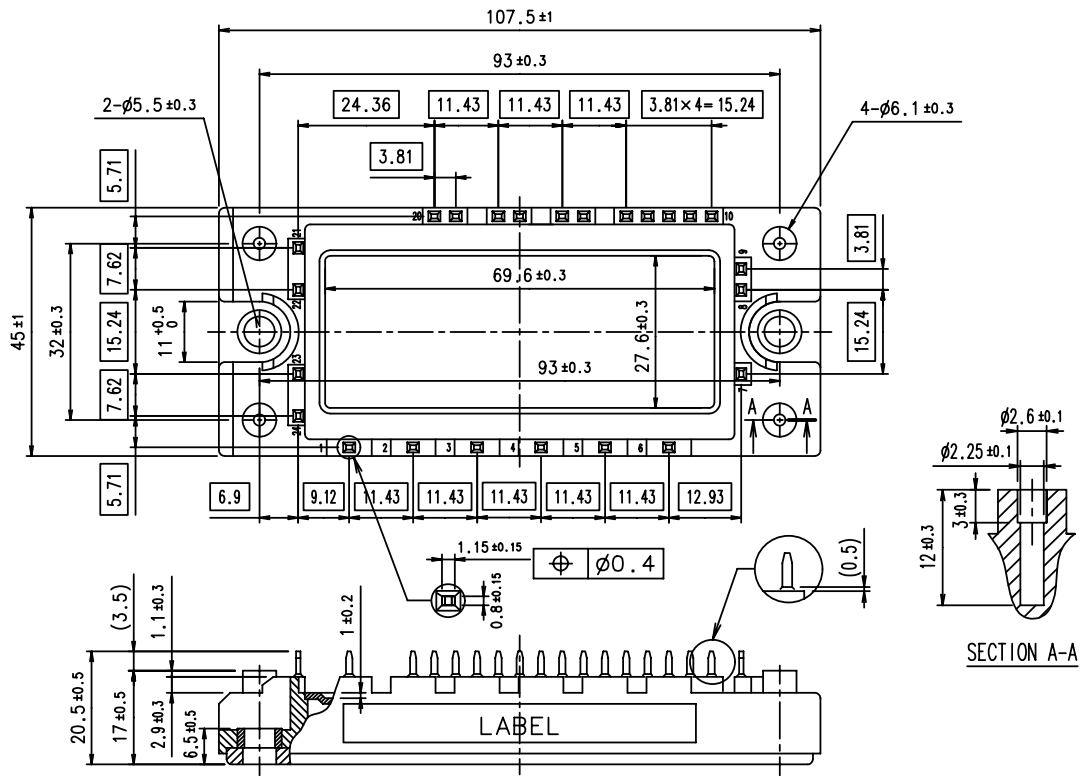

□ shows theoretical dimension.
 () shows reference dimension.