

## Power Integrated Module (PIM)

### ■ Features

- Included Rectifier and Brake Chopper
- Square RBSOA
- Low Saturation Voltage
- Overcurrent Limiting Function  
( ~ 3 Times Rated Current )

### ■ Equivalent Circuit

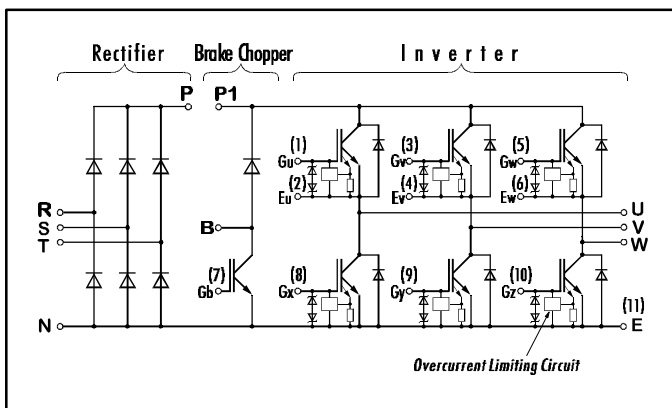

### ■ Outline Drawing

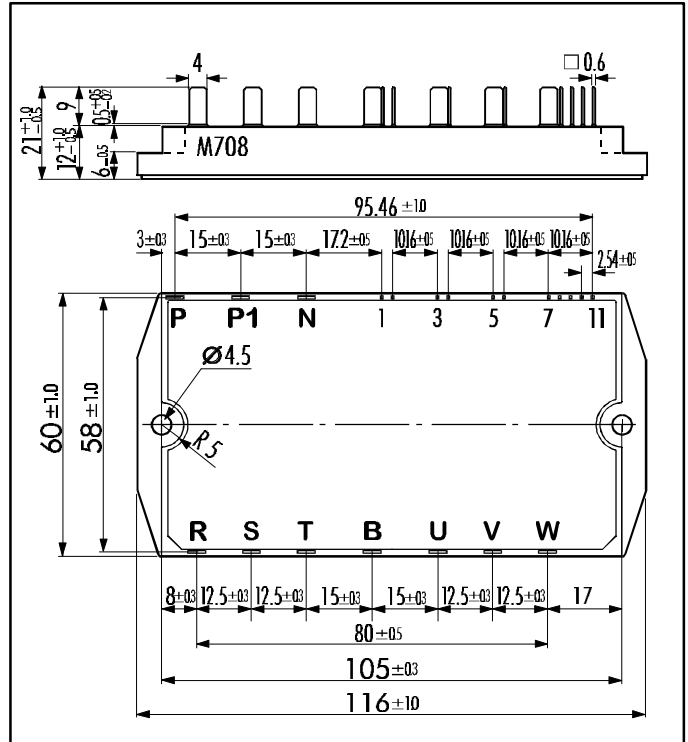

### ■ Absolute Maximum Ratings ( T<sub>c</sub>=25°C )

Items		Symbols	Test Conditions	Ratings	Units
Inverter	Collector-Emitter Voltage	V <sub>CES</sub>		600	V
	Gate -Emitter Voltage	V <sub>GES</sub>		± 20	
	Collector Current	I <sub>C</sub>	Continuous	50	A
		I <sub>C PULSE</sub>	1ms	100	
		-I <sub>C PULSE</sub>	1ms	50	
Collector Power Dissipation	P <sub>C</sub>	1 device	200	W	
Rectifier	Repetitive Peak Reverse Voltage	V <sub>RRM</sub>		800	V
	Non Repetitive Peak Reverse Voltage	V <sub>RSM</sub>		900	
	Average Output Current	I <sub>O</sub>	50Hz/60Hz sin. wave	50	A
	Surge Current (Non Repetitive)	I <sub>FSM</sub>	T <sub>j</sub> =150°C, 10ms	350	
	I <sup>2</sup> t (Non Repetitive)		T <sub>j</sub> =150°C, 10ms	648	
Brake Chopper FWD IGBT	Collector-Emitter Voltage	V <sub>CES</sub>		600	V
	Gate -Emitter Voltage	V <sub>GES</sub>		± 20	
	Collector Current	I <sub>C</sub>	Continuous	50	A
		I <sub>C PULSE</sub>	1ms	100	
	Collector Power Dissipation	P <sub>C</sub>	1 device	200	W
	Repetitive Peak Reverse Voltage	V <sub>RRM</sub>		600	V
	Average Forward Current	I <sub>F(AV)</sub>		1	A
	Surge Current	I <sub>FSM</sub>	10ms	50	
	Operating Junction Temperature	T <sub>j</sub>		+150	°C
	Storage Temperature	T <sub>Stg</sub>		-40 ~ +125	
Isolation Voltage	V <sub>ISO</sub>	A.C. 1min.	2500	V	
Mounting Screw Torque *1			1.7	Nm	

Note: \*1:Recommendable Value; 1.3 ~ 1.7 Nm (M4)

## ■ Electrical Characteristics ( $T_j=25^\circ\text{C}$ )

Items		Symbols	Test Conditions	Min.	Max.	Units	
Inverter	IGBT	Zero Gate Voltage Collector Current	$I_{CES}$	$V_{GE}=0V$ $V_{CE}=600V$		1.0	mA
		Gate-Emitter Leakage Current	$I_{GES}$	$V_{CE}=0V$ $V_{GE}=\pm 20V$		20	$\mu\text{A}$
		Gate-Emitter Threshold Voltage	$V_{GE(th)}$	$V_{GE}=20V$ $I_C=50\text{mA}$	4.5	7.5	V
		Collector-Emitter Saturation Voltage	$V_{CE(sat)}$	$V_{GE}=15V$ $I_C=50A$		2.9	
		Input capacitance	$C_{ies}$	$f=1\text{MHz}$ , $V_{GE}=0V$ , $V_{CE}=10V$	3300 (typ.)		pF
		Turn-on Time	$t_{on}$	$V_{CC} = 300V$ $I_C = 50A$		1.2	$\mu\text{s}$
			$t_r$			0.6	
Turn-off Time	$t_{off}$	$V_{GE} = \pm 15V$ $R_G = 51\Omega$		1.0			
	$t_f$			0.35			
FWD	Diode Forward On-Voltage	$V_F$	$I_F=50A$ $V_{GE}=0V$		3.1	V	
	Reverse Recovery Time	$t_{rr}$	$I_F=50A$		350	ns	
Rectif.	Forward Voltage	$V_{FM}$	$I_F = 50A$		1.55	V	
	Reverse Current	$I_{RRM}$	$V_R = 800V$		1.0	mA	
Brake Chopper	IGBT	Zero Gate Voltage Collector Current	$I_{CES}$	$V_{GE}=0V$ $V_{CE}=600V$		1.0	mA
		Gate-Emitter Leakage Current	$I_{GES}$	$V_{CE}=0V$ $V_{GE}=\pm 20V$		100	nA
		Collector-Emitter Saturation Voltage	$V_{CE(sat)}$	$V_{GE}=15V$ $I_C=50A$		2.8	V
		Turn-on Time	$t_{on}$	$V_{CC} = 300V$ $I_C = 50A$		0.8	$\mu\text{s}$
			$t_r$			0.6	
		Turn-off Time	$t_{off}$	$V_{GE} = \pm 15V$ $R_G = 51\Omega$		1.0	
			$t_f$			0.35	
FWD	Reverse Current	$I_{RRM}$	$V_R=600V$		1.0	mA	
	Reverse Recovery Time	$t_{rr}$			600	ns	

## ■ Thermal Characteristics

Items	Symbols	Test Conditions	Min.	Max.	Units
Thermal Resistance (1 device)	$R_{th(j-c)}$	Inverter IGBT		0.63	$^\circ\text{C/W}$
		Inverter FRD		1.60	
		Brake IGBT		0.63	
		Converter Diode		2.10	
Contact Thermal Resistance	$R_{th(c-f)}$	With Thermal Compound	0.05 (typ.)		

Collector current vs. Collector-Emitter voltage  
 $T_j=25^\circ\text{C}$

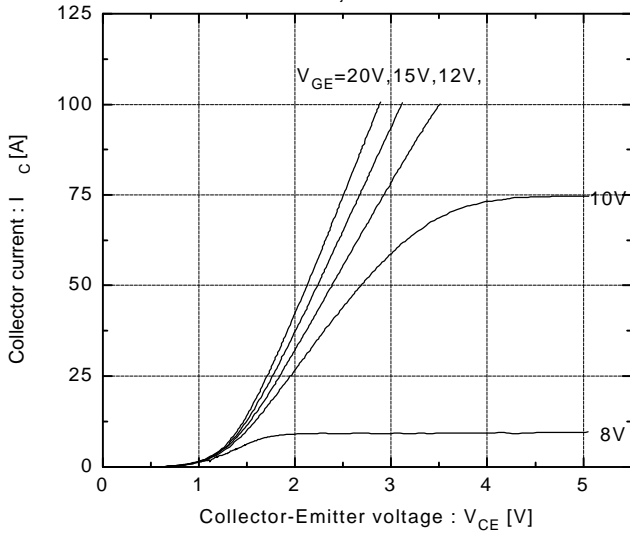

Collector current vs. Collector-Emitter voltage  
 $T_j=125^\circ\text{C}$

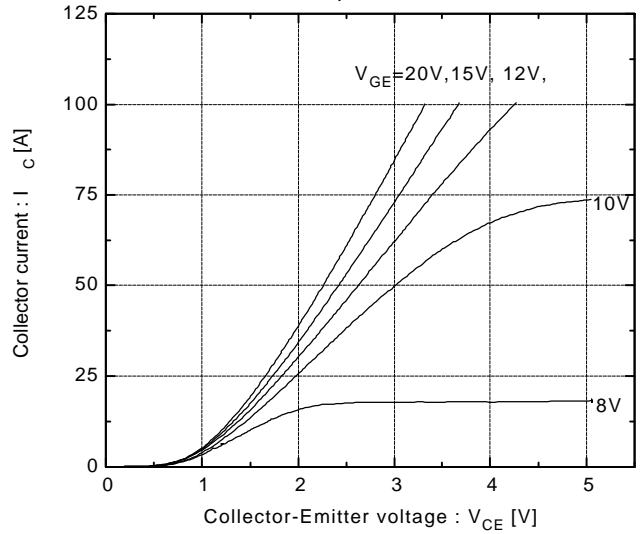

Collector-Emitter vs. Gate-Emitter voltage  
 $T_j=25^\circ\text{C}$

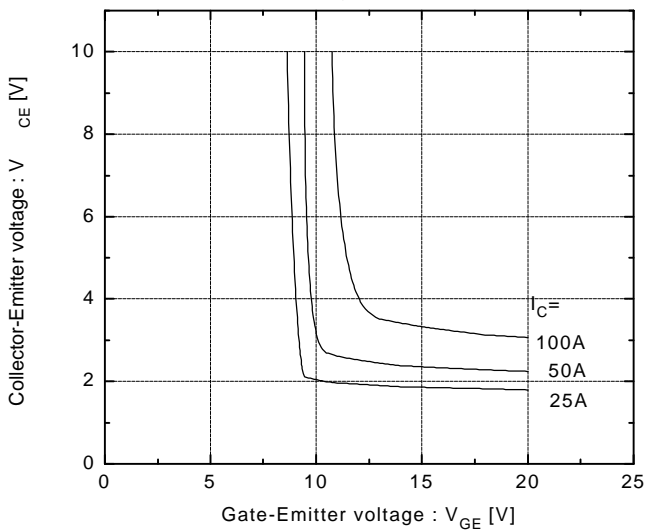

Collector-Emitter vs. Gate-Emitter voltage  
 $T_j=125^\circ\text{C}$

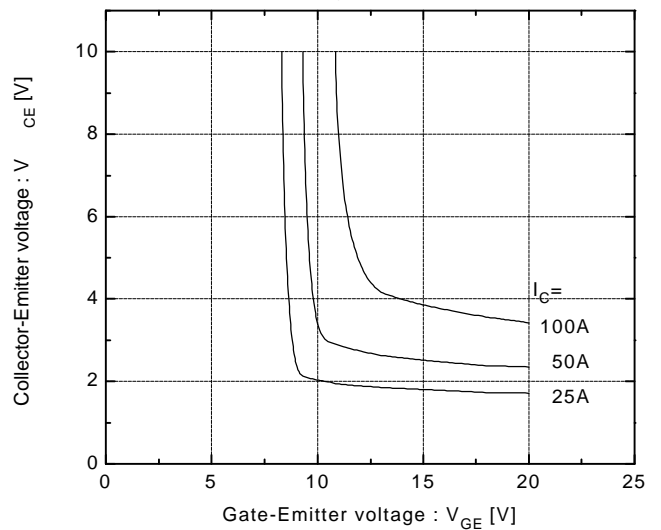

Switching time vs. Collector current  
 $V_{CC}=300\text{V}, R_G=51\Omega, V_{GE}=\pm 15\text{V}, T_j=25^\circ\text{C}$

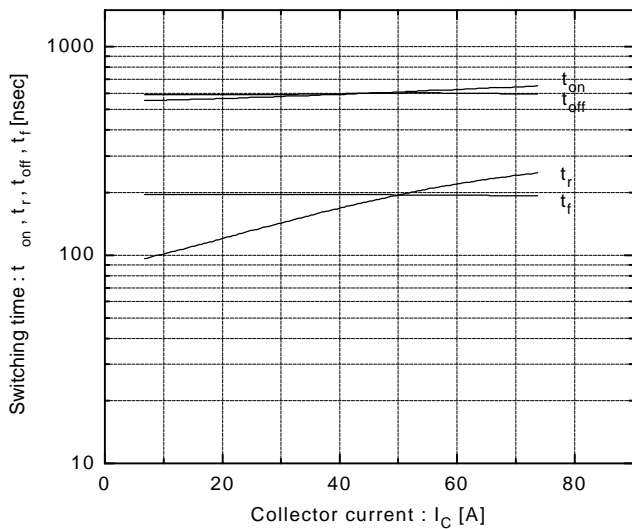

Switching time vs. Collector current  
 $V_{CC}=300\text{V}, R_G=51\Omega, V_{GE}=\pm 15\text{V}, T_j=125^\circ\text{C}$

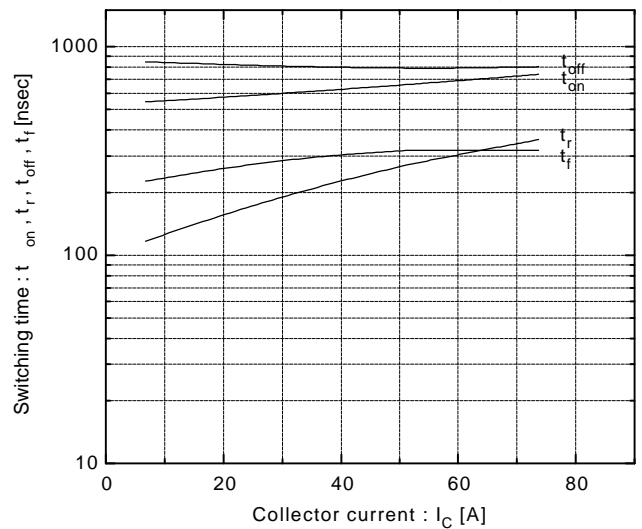

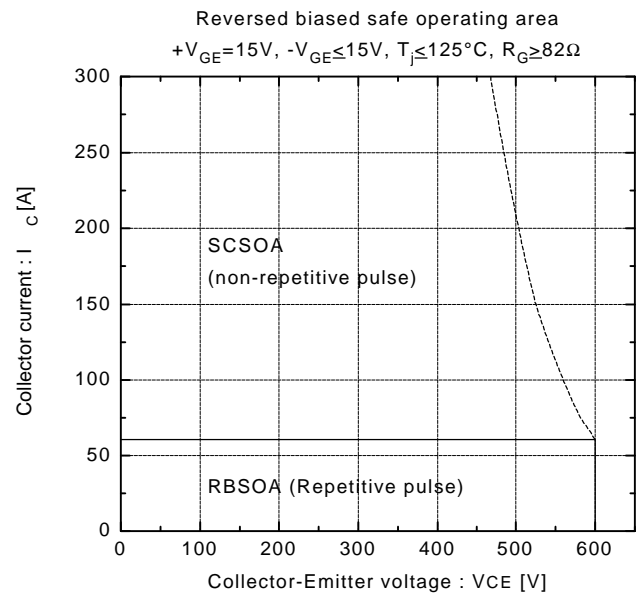
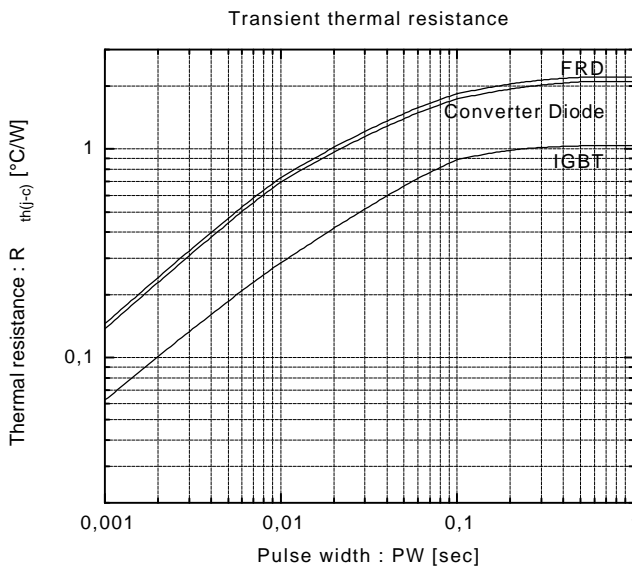
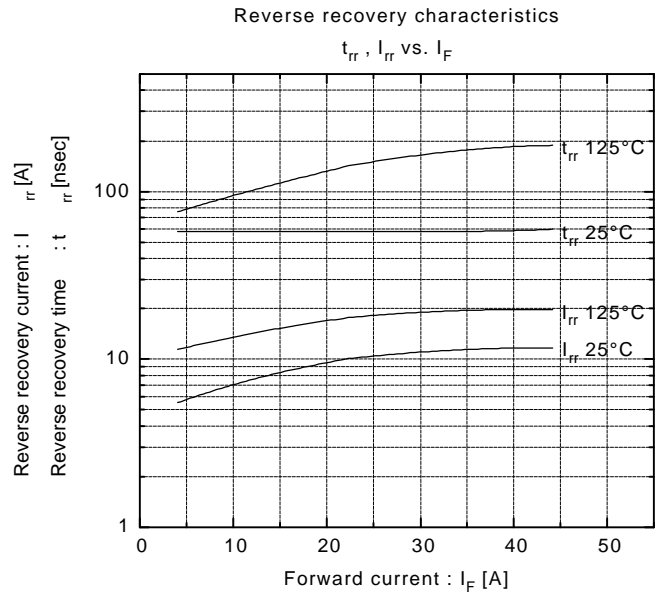
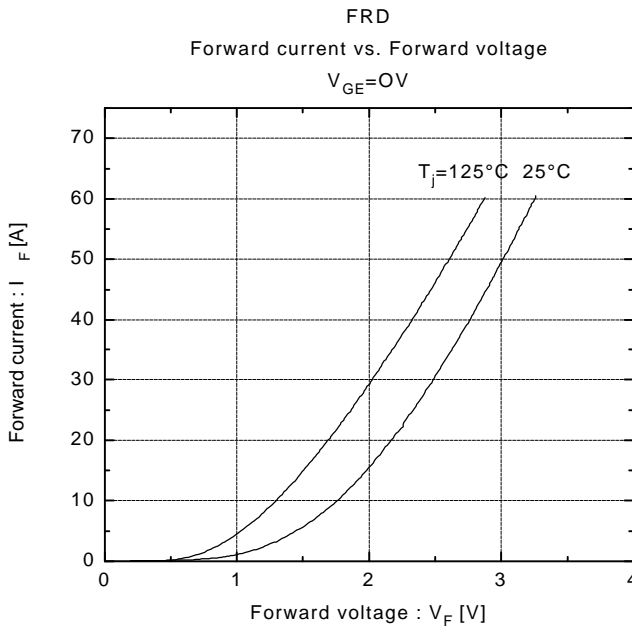
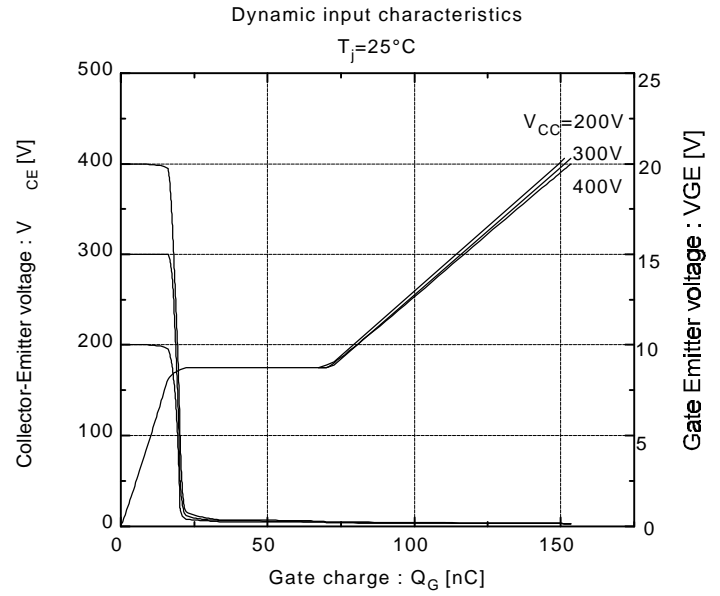
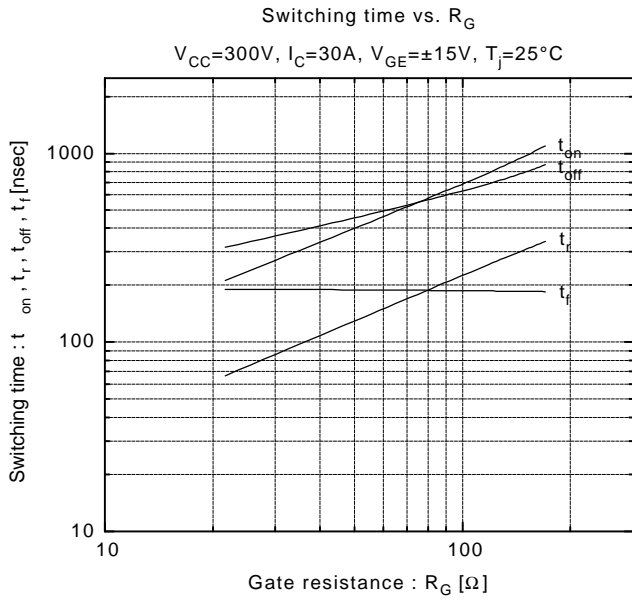

Switching loss vs. Collector current  
 $V_{CC}=300V, R_G=51\Omega, V_{GE}=\pm 15V$

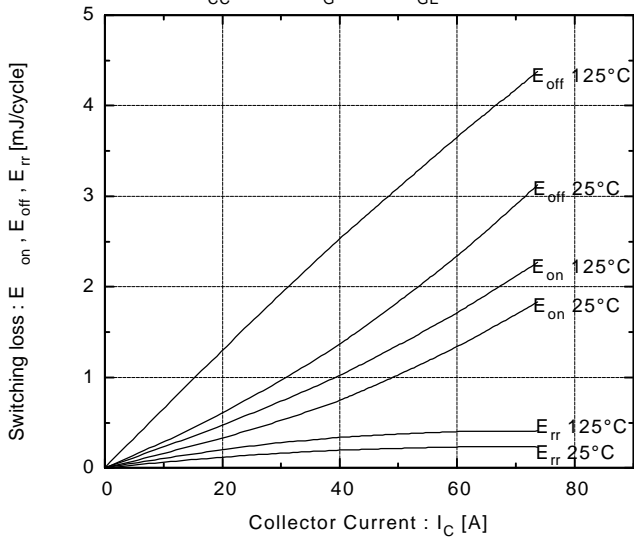

Capacitance vs. Collector-Emitter voltage  
 $T_j=25^\circ C$

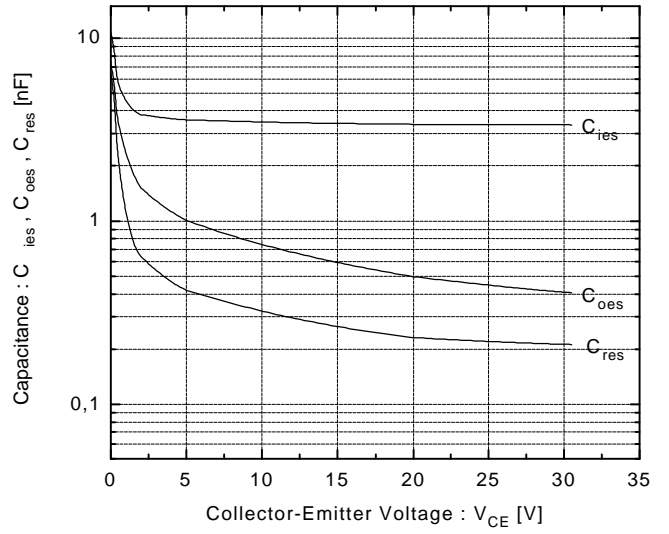

Converter Diode  
 Forward current vs. Forward voltage  
 $V_{GE}=0V$

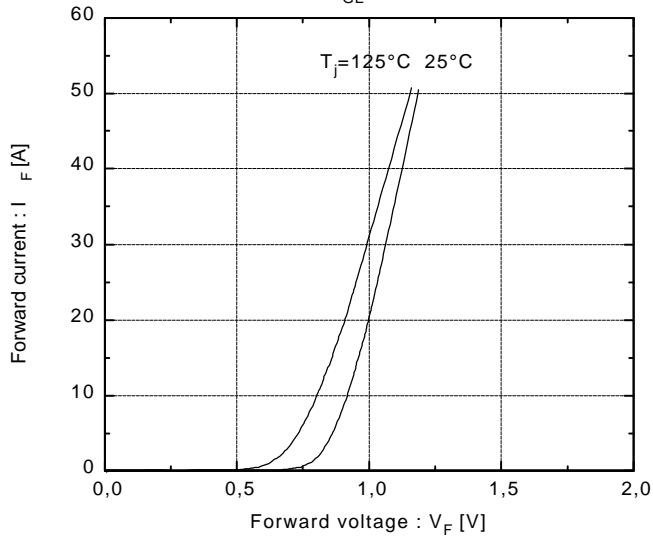

## Brake Chopper IGBT

Collector current vs. Collector-Emittor voltage

$T_j=25^{\circ}\text{C}$

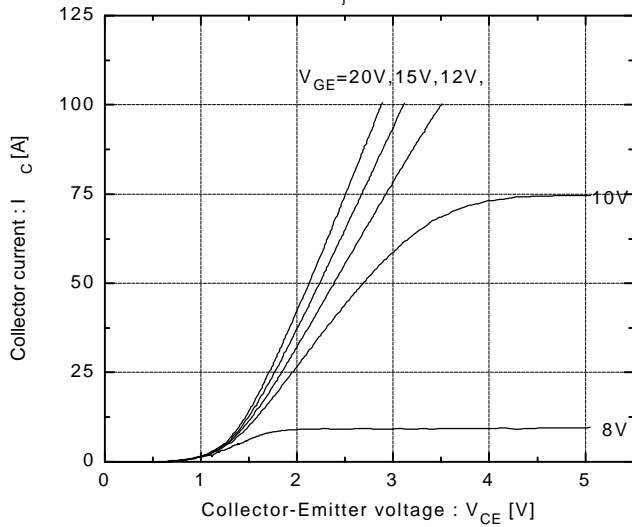

Collector current vs. Collector-Emittor voltage

$T_j=125^{\circ}\text{C}$

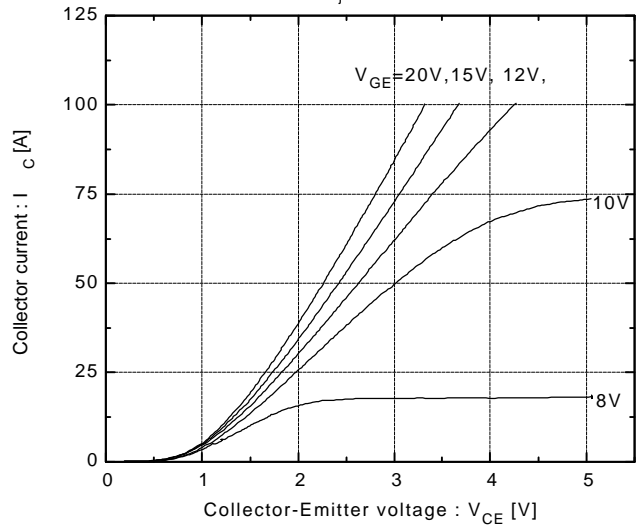

Collector-Emittor vs. Gate-Emittor voltage

$T_j=25^{\circ}\text{C}$

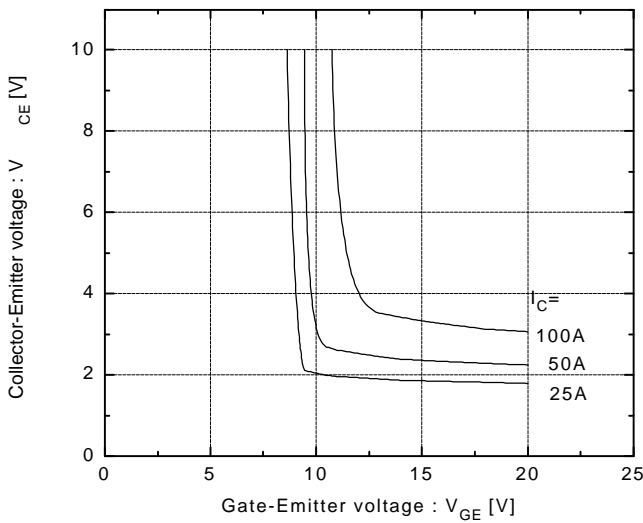

Collector-Emittor vs. Gate-Emittor voltage

$T_j=125^{\circ}\text{C}$

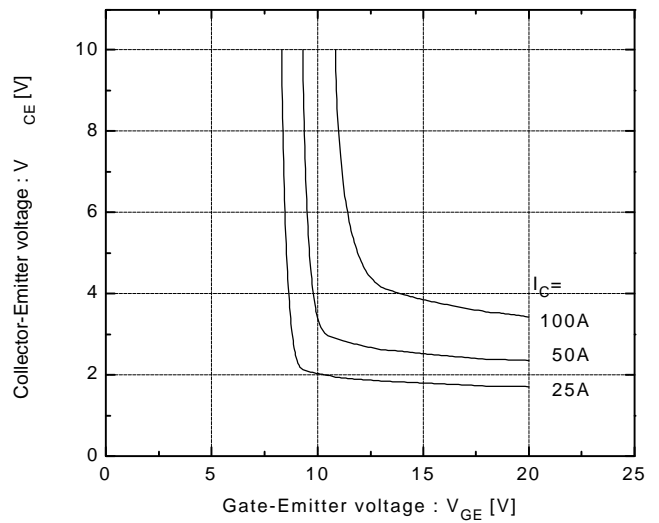

Switching time vs. Collector current

$V_{CC}=300\text{V}, R_G=51\Omega, V_{GE}=\pm 15\text{V}, T_j=25^{\circ}\text{C}$

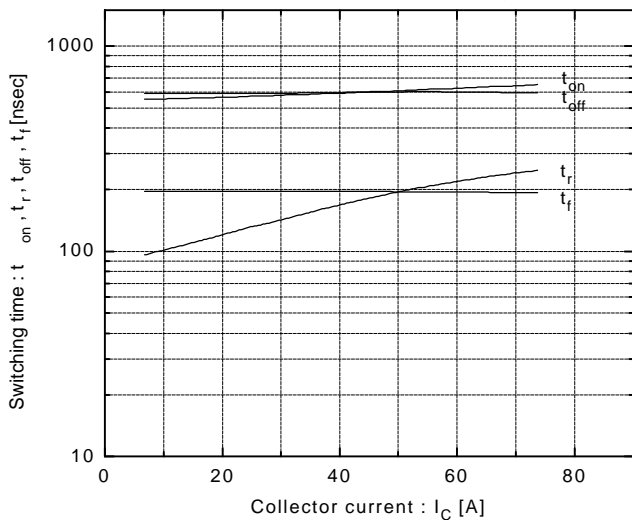

Switching time vs. Collector current

$V_{CC}=300\text{V}, R_G=51\Omega, V_{GE}=\pm 15\text{V}, T_j=125^{\circ}\text{C}$

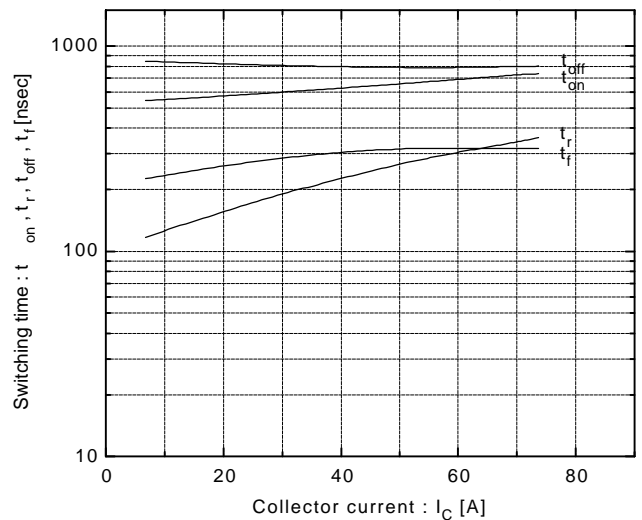

## Brake Chopper IGBT

