

Features

- High speed switching
- Low on-resistance
- No secondary breakdown
- Low driving power
- Avalanche-proof

Applications

- Switching regulators
- UPS (Uninterruptible Power Supply)
- DC-DC converters

Maximum ratings and characteristic Absolute maximum ratings

(Tc=25°C unless otherwise specified)

Item	Symbol	Ratings	Unit
Drain-source voltage	V _{DS}	600	V
Continuous drain current	I _D	±8	A
Pulsed drain current	I _{D(puls)}	±32	A
Gate-source voltage	V _{GS}	±30	V
Repetitive or non-repetitive	IAR *2	8	A
Maximum Avalanche Energy	EAS *1	145.6	mJ
Maximum Drain-Source dV/dt	dV _{DS} /dt *4	20	kV/μs
Peak Diode Recovery dV/dt	dV/dt *3	5	kV/μs
Max. power dissipation	P _D	T _a =25°C	2.02
		T _c =25°C	135
Operating and storage temperature range	T _{ch}	+150	°C
	T _{stg}	-55 to +150	°C

*1 L=4.2mH, V_{CC}=60V, See to Avalanche Energy Graph *2 T_{ch}≤150°C

*3 I_F≤-I_D, -di/dt=50A/μs, V_{CC}≤BV_{DSS}, T_{ch}≤150°C *4 V_{DS}≤600V

Electrical characteristics (T_c =25°C unless otherwise specified)

Item	Symbol	Test Conditions	Min.	Typ.	Max.	Units
Drain-source breakdown voltage	V _{(BR)DSS}	I _D =250μA V _{GS} =0V	600			V
Gate threshold voltage	V _{GS(th)}	I _D =250μA V _{DS} =V _{GS}	3.0		5.0	V
Zero gate voltage drain current	I _{DSS}	V _{DS} =600V V _{GS} =0V V _{DS} =480V V _{GS} =0V	T _{ch} =25°C		25	μA
			T _{ch} =125°C		250	
Gate-source leakage current	I _{GSS}	V _{GS} =±30V V _{DS} =0V		10	100	nA
Drain-source on-state resistance	R _{DS(on)}	I _D =3A V _{GS} =10V		0.93	1.20	Ω
Forward transconductance	g _{fs}	I _D =3A V _{DS} =25V	3	6		S
Input capacitance	C _{iss}	V _{DS} =25V V _{GS} =0V f=1MHz		750	1130	pF
Output capacitance	C _{oss}			100	150	
Reverse transfer capacitance	C _{rss}			4.0	6.0	
Turn-on time t _{on}	td(on)	V _{CC} =300V I _D =3A V _{GS} =10V		14	21	ns
	t _r			9	14	
Turn-off time t _{off}	td(off)	R _{GS} =10 Ω		24	36	ns
	t _r			7	10.5	
Total Gate Charge	Q _G	V _{CC} =300V		20	30	nC
Gate-Source Charge	Q _{GS}	I _D =6A		8.5	13	
Gate-Drain Charge	Q _{GD}	V _{GS} =10V		5.5	8.5	
Avalanche capability	I _{AV}	L=4.2mH T _{ch} =25°C	8			A
Diode forward on-voltage	V _{SD}	I _F =6A V _{GS} =0V T _{ch} =25°C		1.00	1.50	V
Reverse recovery time	t _{rr}	I _F =6A V _{GS} =0V		0.7		μs
Reverse recovery charge	Q _{rr}	-di/dt=100A/μs T _{ch} =25°C		3.5		μC

Thermal characteristics

Item	Symbol	Test Conditions	Min.	Typ.	Max.	Units
Thermal resistance	R _{th(ch-c)}	channel to case			0.926	°C/W
	R _{th(ch-a)}	channel to ambient			62.0	°C/W

Outline Drawings [mm]

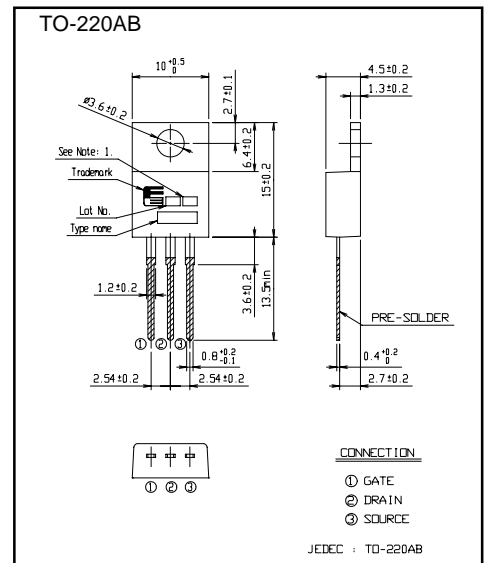

Equivalent circuit schematic

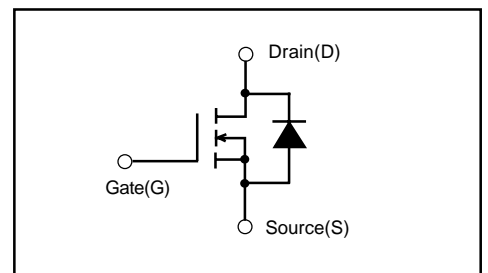

■ Characteristics

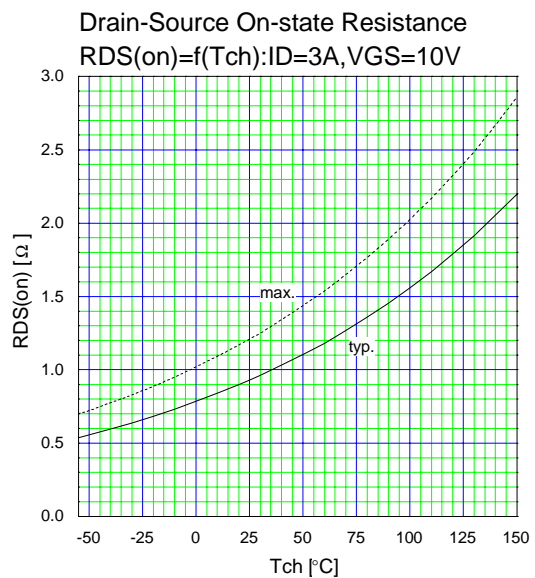
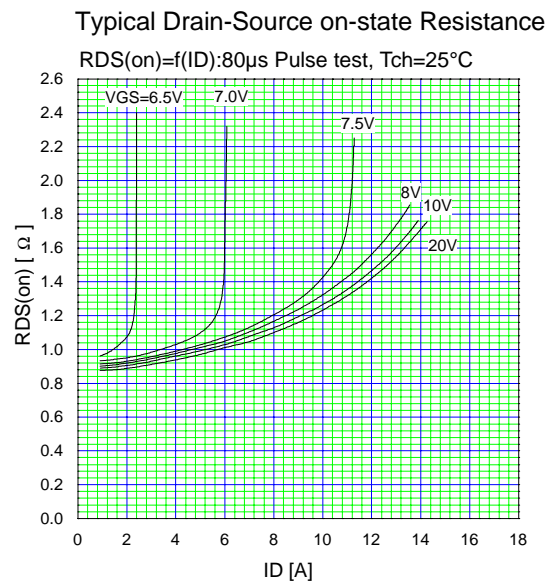
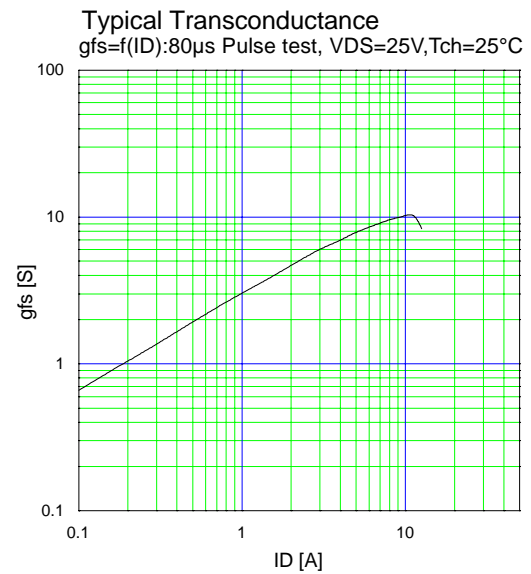
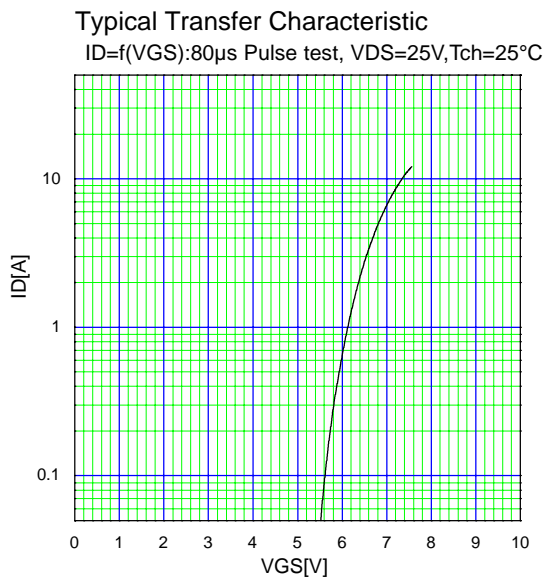
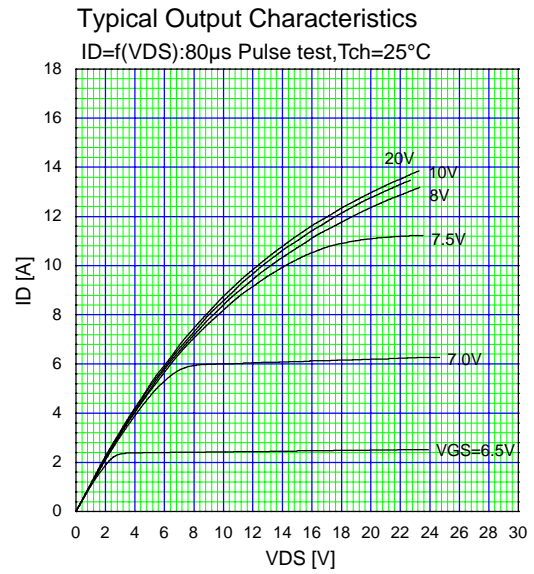
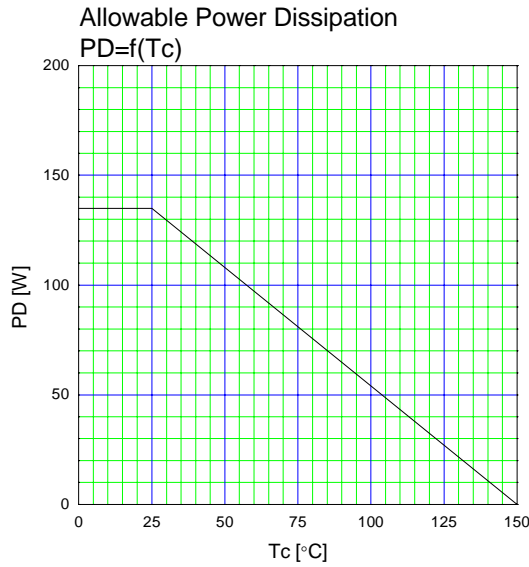

Gate Threshold Voltage vs. T_{ch}

V_{GS(th)}=f(T_{ch}):V_{DS}=V_{GS},I_D=250μA

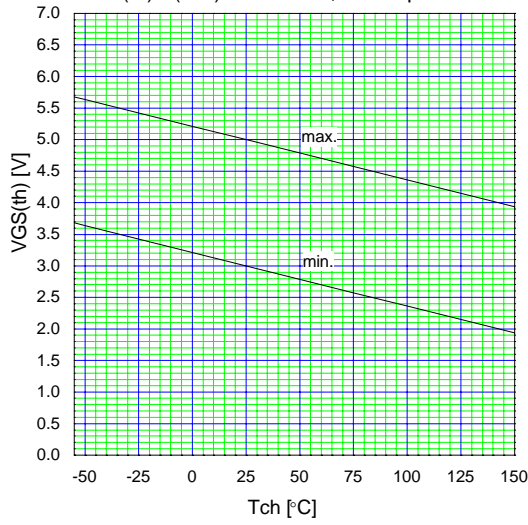

Typical Gate Charge Characteristics

V_{GS}=f(Q_g):I_D=3A, T_{ch}=25°C

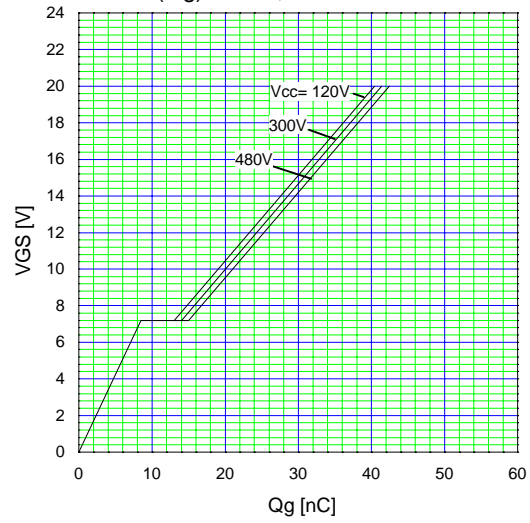

Typical Capacitance

C=f(V_{DS}):V_{GS}=0V,f=1MHz

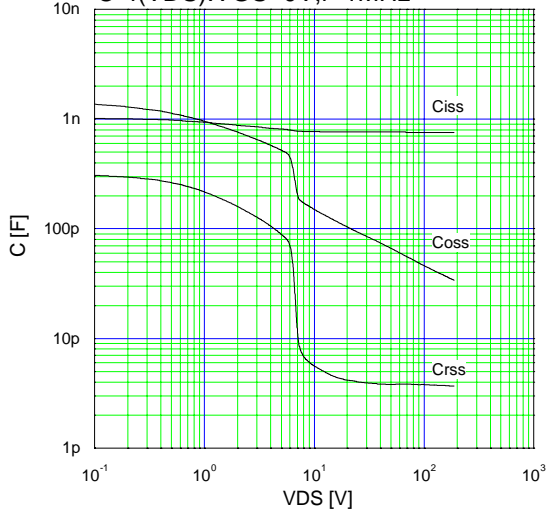

Typical Forward Characteristics of Reverse Diode

I_F=f(V_{SD}):80μs Pulse test,T_{ch}=25°C

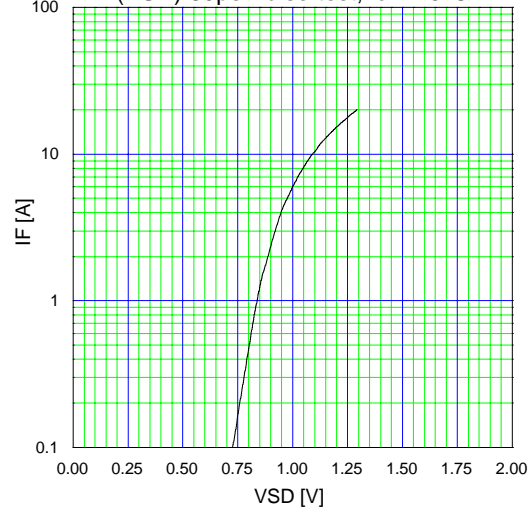

Typical Switching Characteristics vs. I_D

t=f(I_D):V_{cc}=300V, V_{GS}=10V, R_G=10Ω

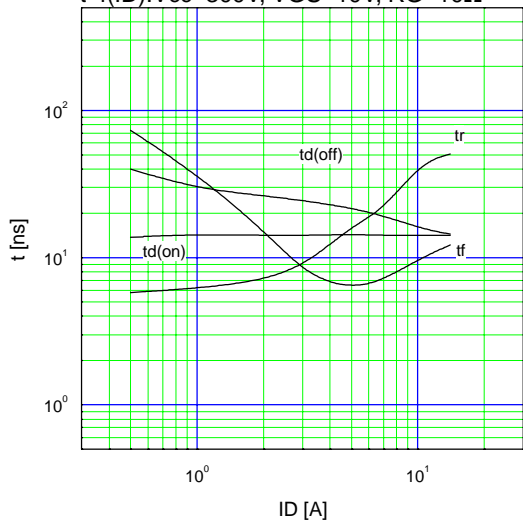

Maximum Avalanche Energy vs. starting T_{ch}

E_{AS}=f(starting T_{ch}):V_{cc}=60V

