

REV.	ECN. No.	APPD.
A	HC-05-4500	Ady Zhou 5/19/05
B	HC061417	Yusan 2/21/06
C	BC07703352	Yusan

NOTES: UNLESS OTHERWISE SPECIFIED

- DIMENSIONS SHALL BE INTERPRETED PER ANSI Y14.5M-1994
- SPEC. OF PROD. ARE SHOWN ON DRAWING "303-0300-1130".
- MATERIAL OF PARTS ARE SHOWN ON DRAWING "303-0500-1130".
- DATE CODE: PLEASE REFER TO FOXCONN'S DOC. "EB2-YY00-039".
- PRODUCT No. MATRIX : PLEASE REFER TO DRAWING "303-0000-1747".
- THE "FOXCONN" LOGO IS LOCATED APPROX. AS SHOWN.
- HARMFUL MATERIAL CONTROL PLEASE FOLLOW FOXCONN'S DOC. "EPI12".
- PLEASE CONTACT FOXCONN'S SALES REPRESENTATIVE TO VERIFY PRODUCT DETAILS & AVAILABILITY.

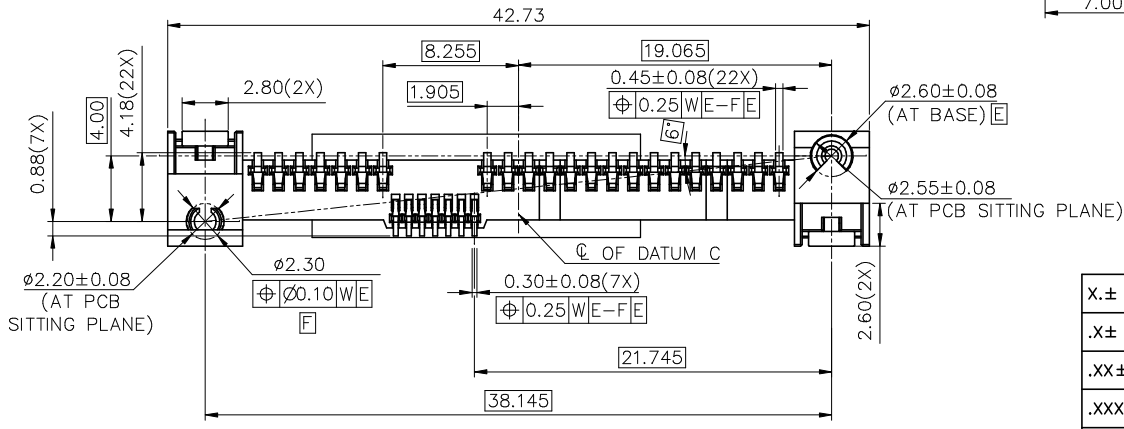
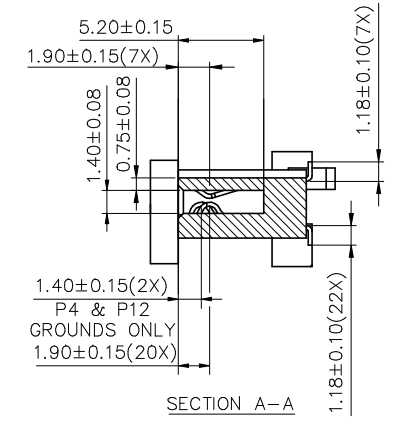
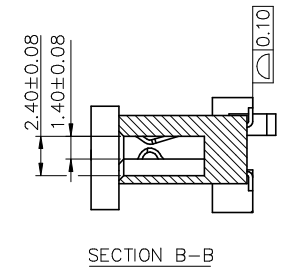
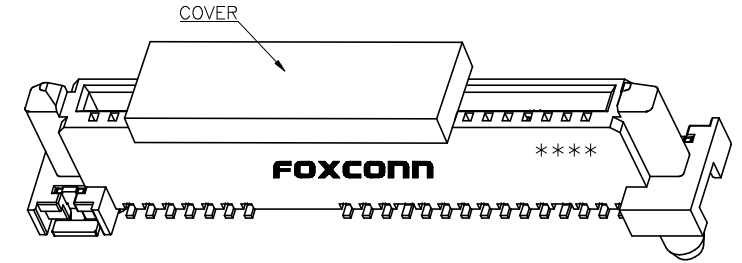
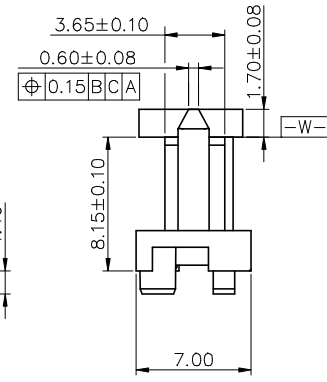
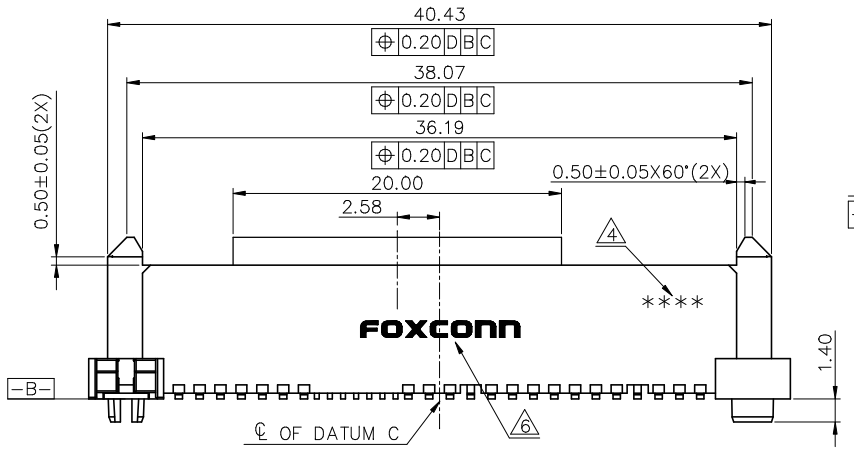
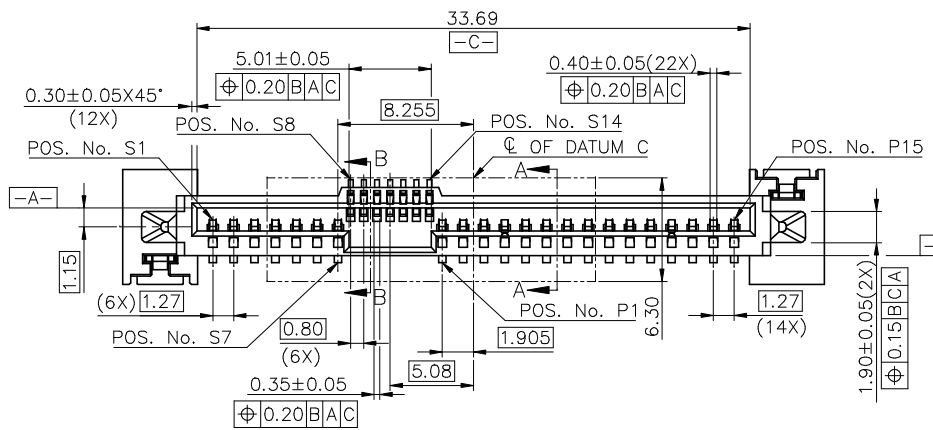

X.±	X'± 1'	UNITS	mm	NAME(INTENDED USE)
.X± 0.38	.X'±	MAT'L		SAS
.XX± 0.25	.XX'±			PART NO.(INTENDED USE)
.XXX± 0.15	.XXX'±	FINISH		LD2529*-A02**
Q'TY				APPD: Yusan
THESE DRAWINGS AND SPECIFICATIONS ARE THE PROPERTY OF HON HAI PRECISION IND. CO., LTD. AND SHALL NOT BE REPRODUCED, COPIED OR USED IN ANY MANNER WITHOUT THE PRIOR WRITTEN CONSENT OF HON HAI PRECISION IND. CO., LTD.				CHKD: Steven
				DR: Denis Zhu 1/16/07

PART No.	LD2529*-A02T6
FOXCONN HON HAI PRECISION IND. CO.,LTD. TAIPEI, TAIWAN, R.O.C.	
TITLE: CUSTOMER DRAWING V/T SMT,SAS RECEPTACLE	
DWG No.: 303-0000-1390	
SCALE	SHEET
N/A	1/2
REV.	C

REV.	ECN. No.	APPD.

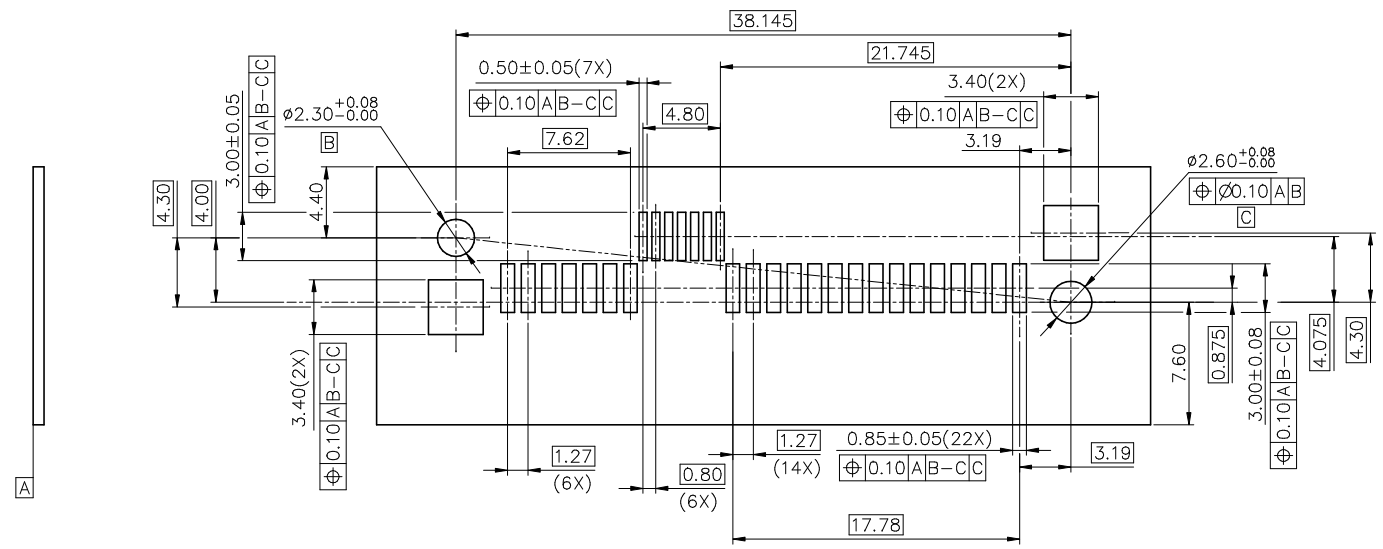

RECOMMENDED P.C.B. LAYOUT

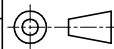
THESE DRAWINGS AND SPECIFICATIONS ARE THE PROPERTY OF HON HAI PRECISION IND. CO., LTD. AND SHALL NOT BE REPRODUCED, COPIED OR USED IN ANY MANNER WITHOUT THE PRIOR WRITTEN CONSENT OF HON HAI PRECISION IND. CO., LTD.	X.±	X°.± 1°	UNITS	mm	NAME(INTENDED USE)	FOXCONN HON HAI PRECISION IND. CO.,LTD. TAIPEI, TAIWAN, R.O.C.
	.X± 0.38	.X°±	MAT'L		SAS	
	.XX± 0.25	.XX°±	FINISH	Q'TY	PART NO.(INTENDED USE)	TITLE: CUSTOMER DRAWING
	.XXX± 0.15	.XXX°±			LD2529*-A02**	V/T SMT,SAS RECEPTACLE
					APPD: Yusan	DWG NO.:
					CHKD: Steven	303-0000-1390
					DR: Denis Zhu 1/16'07	 SCALE SHEET REV. N/A 2/2 C