

N

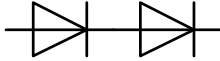

Datenblatt / Data sheet

Netz-Dioden-Modul
Rectifier Diode Module
DD171N

 Infineon Technologies Bipolar
 GmbH & Co. KG

DD171N
ND171N
DD171N..K..-A
DD171N..K..-K
Elektrische Eigenschaften / Electrical properties
 Höchstzulässige Werte / Maximum rated values

| | | | | | |
|--|--|-------------|--------------|--------------------|--------------------------------------|
| Periodische Spitzensperrspannung repetitive peak reverse voltages | $T_{vj} = -40^{\circ}\text{C} \dots T_{vj\text{max}}$ | V_{RRM} | 1200 1600 | 1400 1800 | V V |
| Stoßspitzensperrspannung non-repetitive peak reverse voltage | $T_{vj} = +25^{\circ}\text{C} \dots T_{vj\text{max}}$ | V_{RSM} | 1300 1700 | 1500 1900 | V V |
| Durchlaßstrom-Grenzeffektivwert maximum RMS on-state current | | I_{FRMSM} | | 270 | A |
| Dauergrenzstrom average on-state current | $T_C = 100^{\circ}\text{C}$ | I_{FAVM} | | 171 | A |
| Stoßstrom-Grenzwert surge current | $T_{vj} = 25^{\circ}\text{C}, t_p = 10\text{ ms}$ $T_{vj} = T_{vj\text{max}}, t_p = 10\text{ ms}$ | I_{FSM} | | 6.600 5.600 | A A |
| Grenzlastintegral I^2t -value | $T_{vj} = 25^{\circ}\text{C}, t_p = 10\text{ ms}$ $T_{vj} = T_{vj\text{max}}, t_p = 10\text{ ms}$ | I^2t | | 218.000 157.000 | A ² s A ² s |

Charakteristische Werte / Characteristic values

| | | | | | |
|--|--|------------|------|------------|----------|
| Durchlaßspannung on-state voltage | $T_{vj} = T_{vj\text{max}}, I_F = 500\text{ A}$ | V_F | max. | 1,26 | V |
| Schleusenspannung threshold voltage | $T_{vj} = T_{vj\text{max}}$ | $V_{(TO)}$ | | 0,75 | V |
| Ersatzwiderstand slope resistance | $T_{vj} = T_{vj\text{max}}$ | r_T | | 0,8 | mΩ |
| Sperrstrom reverse current | $T_{vj} = T_{vj\text{max}}, V_R = V_{RRM}$ | i_R | max. | 20 | mA |
| Isolations-Prüfspannung insulation test voltage | RMS, $f = 50\text{ Hz}, t = 1\text{ sec}$ RMS, $f = 50\text{ Hz}, t = 1\text{ min}$ | V_{ISOL} | | 3,0 2,5 | kV kV |

Thermische Eigenschaften / Thermal properties

| | | | | | |
|--|--|--------------------|------|----------------------------------|------------------------------|
| Innerer Wärmewiderstand thermal resistance, junction to case | pro Modul / per Module, $\Theta = 180^{\circ}\text{ sin}$ pro Zweig / per arm, $\Theta = 180^{\circ}\text{ sin}$ pro Modul / per Module, DC pro Zweig / per arm, DC | R_{thJC} | max. | 0,130 0,260 0,126 0,252 | °C/W °C/W °C/W °C/W |
| Übergangs-Wärmewiderstand thermal resistance, case to heatsink | pro Modul / per Module pro Zweig / per arm | R_{thCH} | max. | 0,03 0,06 | °C/W °C/W |
| Höchstzulässige Sperrschichttemperatur maximum junction temperature | | $T_{vj\text{max}}$ | | 150 | °C |
| Betriebstemperatur operating temperature | | $T_{c\text{op}}$ | | - 40...+150 | °C |
| Lagertemperatur storage temperature | | T_{stg} | | - 40...+150 | °C |

| | | | |
|--------------|-----------|----------------------|------------|
| prepared by: | M.Stelte | date of publication: | 2011-03-01 |
| approved by: | M.Leifeld | revision: | 3.0 |

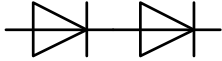
N**Datenblatt / Data sheet****Netz-Dioden-Modul
Rectifier Diode Module****DD171N**Infineon Technologies Bipolar
GmbH & Co. KG**Mechanische Eigenschaften / Mechanical properties**

| | | | | |
|---|---------------|----|-------------------|------------------|
| Gehäuse, siehe Anlage case, see annex | | | Seite 3 page 3 | |
| Si-Element mit Druckkontakt Si-pellet with pressure contact | | | | |
| Innere Isolation internal insulation | | | AIN | |
| Anzugsdrehmoment für mechanische Anschlüsse mounting torque | Toleranz ±15% | M1 | 6 | Nm |
| Anzugsdrehmoment für elektrische Anschlüsse terminal connection torque | Toleranz ±10% | M2 | 6 | Nm |
| Gewicht weight | | G | typ. 310 | g |
| Kriechstrecke creepage distance | | | 15 | mm |
| Schwingfestigkeit vibration resistance | f = 50 Hz | | 50 | m/s ² |
|  | file-No. | | E 83336 | |

N

Datenblatt / Data sheet



Netz-Dioden-Modul
Rectifier Diode Module

DD171N

Infineon Technologies Bipolar
GmbH & Co. KG

screwing depth
max. 11,0

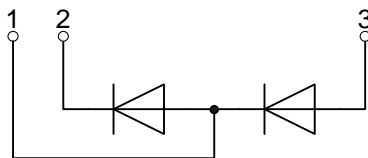
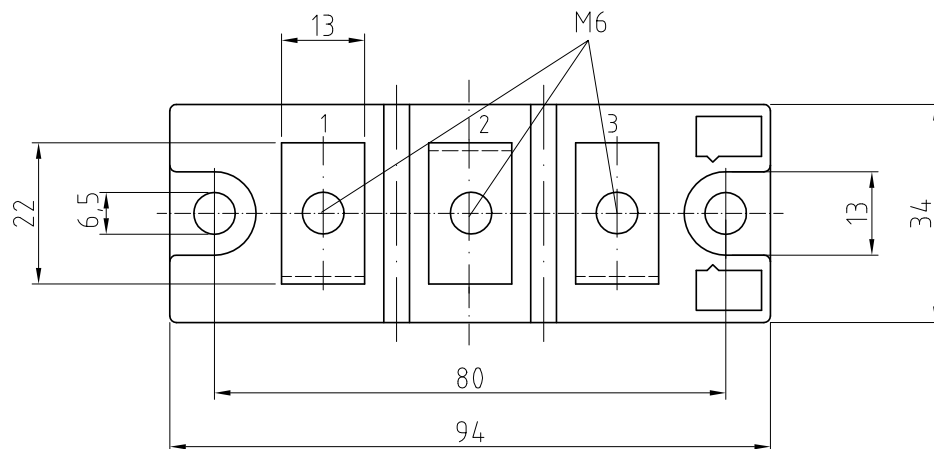
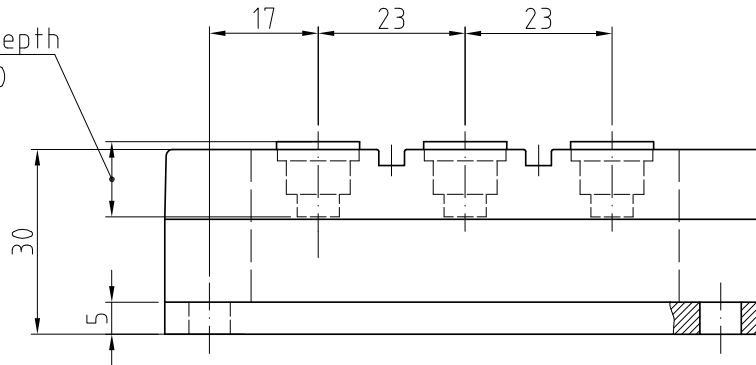

DD

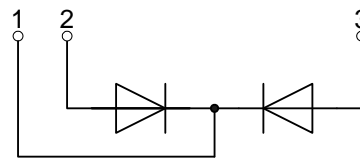

DD-K

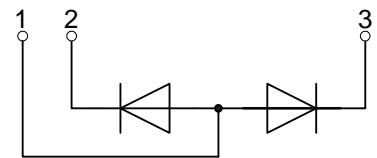

DD-A

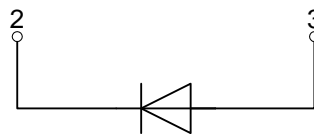

ND



Analytische Elemente des transienten Wärmewiderstandes Z_{thJC} für DC
Analytical elements of transient thermal impedance Z_{thJC} for DC

| Pos. n | 1 | 2 | 3 | 4 | 5 | 6 | 7 |
|------------------|--------|--------|--------|-------|---|---|---|
| R_{thn} [°C/W] | 0,0094 | 0,0224 | 0,0586 | 0,162 | | | |
| T_n [s] | 0,0014 | 0,0253 | 0,267 | 1,68 | | | |

Analytische Funktion / Analytical function:

$$Z_{thJC} = \sum_{n=1}^{n_{max}} R_{thn} \left(1 - e^{-\frac{t}{\tau_n}} \right)$$

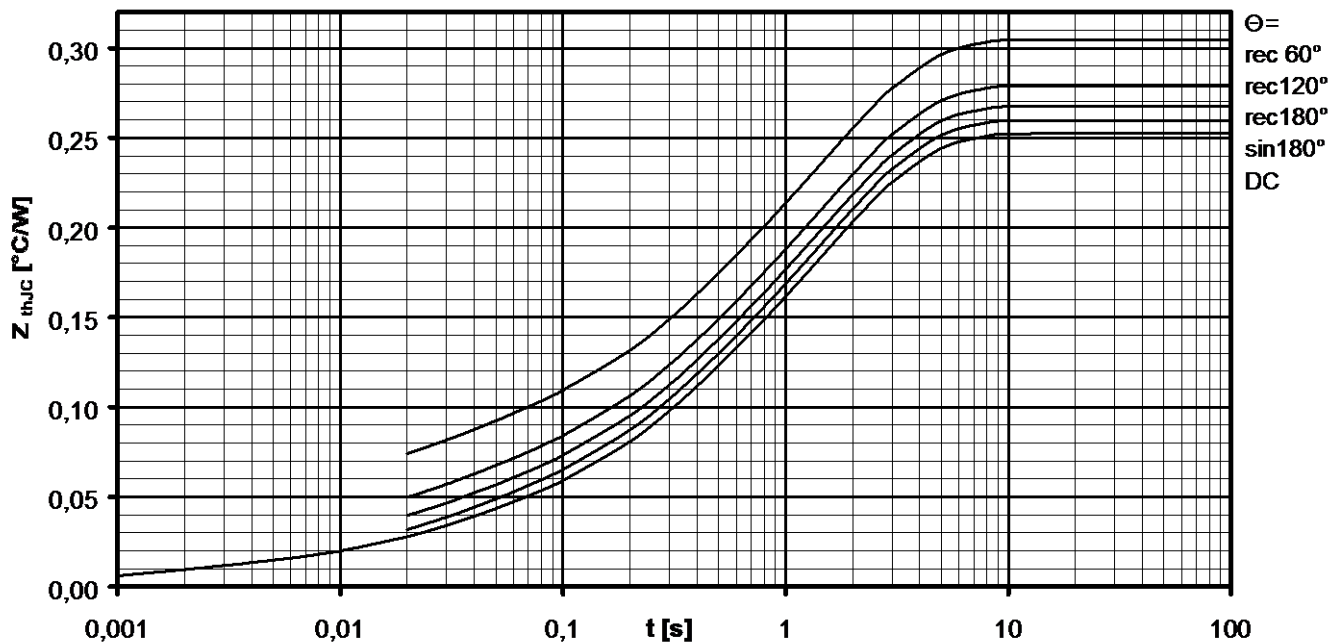

Transienter innerer Wärmewiderstand je Zweig / Transient thermal impedance per arm $Z_{thJC} = f(t)$

Parameter: Stromflußwinkel Θ / Current conduction angle Θ



Natürliche Kühlung / Natural cooling
 3 Module pro Kühler / 3 modules per heatsink
 Kühler / Heatsink type: KM17 (60W)

Analytische Elemente des transienten Wärmewiderstandes Z_{thCA}
Analytical elements of transient thermal impedance Z_{thCA}

| Pos. n | 1 | 2 | 3 | 4 | 5 | 6 | 7 |
|------------------|--------|--------|-------|---|---|---|---|
| R_{thn} [°C/W] | 0,0505 | 0,1235 | 1,616 | | | | |
| T_n [s] | 2,97 | 21,4 | 1180 | | | | |

Verstärkte Kühlung / Forced cooling
 3 Module pro Kühler / 3 modules per heatsink
 Kühler / Heatsink type: KM17 (Papst 4650)

Analytische Elemente des transienten Wärmewiderstandes Z_{thCA}
Analytical elements of transient thermal impedance Z_{thCA}

| Pos. n | 1 | 2 | 3 | 4 | 5 | 6 | 7 |
|------------------|-------|-------|-------|---|---|---|---|
| R_{thn} [°C/W] | 0,026 | 0,119 | 0,515 | | | | |
| T_n [s] | 2,41 | 13,6 | 354 | | | | |

Analytische Funktion / Analytical function:

$$Z_{thCA} = \sum_{n=1}^{n_{max}} R_{thn} \left(1 - e^{-\frac{t}{T_n}} \right)$$

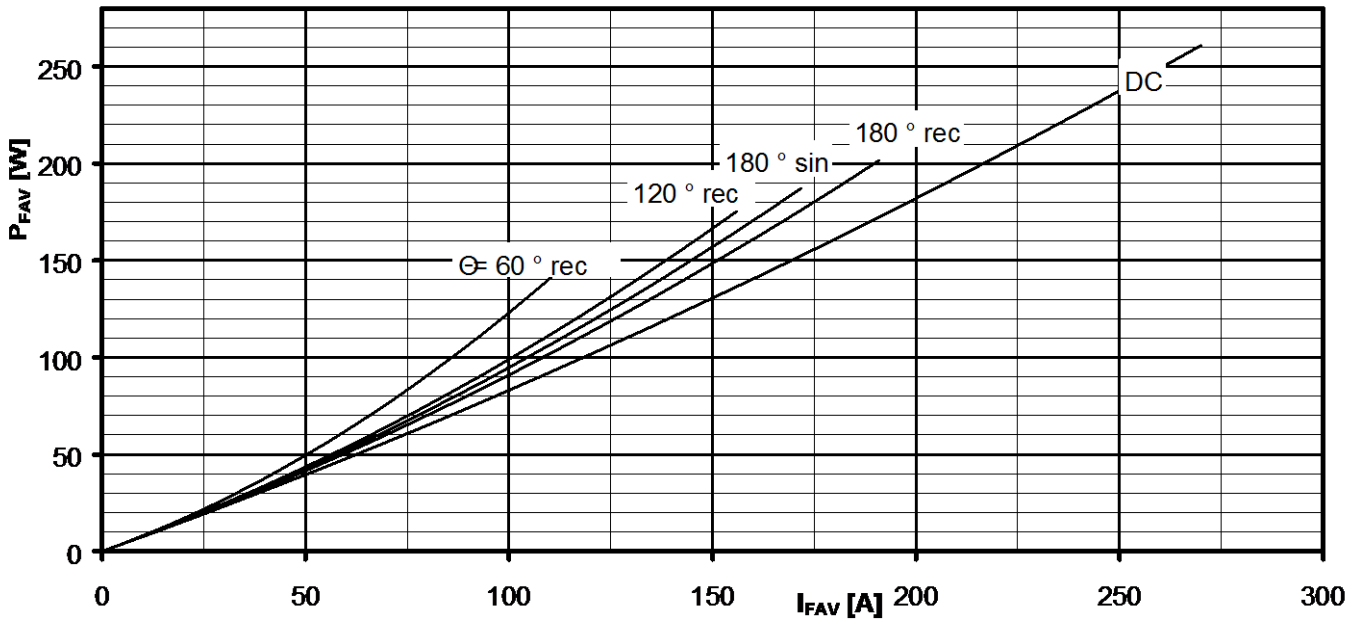

Durchlassverlustleistung je Zweig / On-state power loss per arm $P_{FAV} = f(I_{FAV})$

Parameter: Stromflußwinkel / Current conduction angle Θ

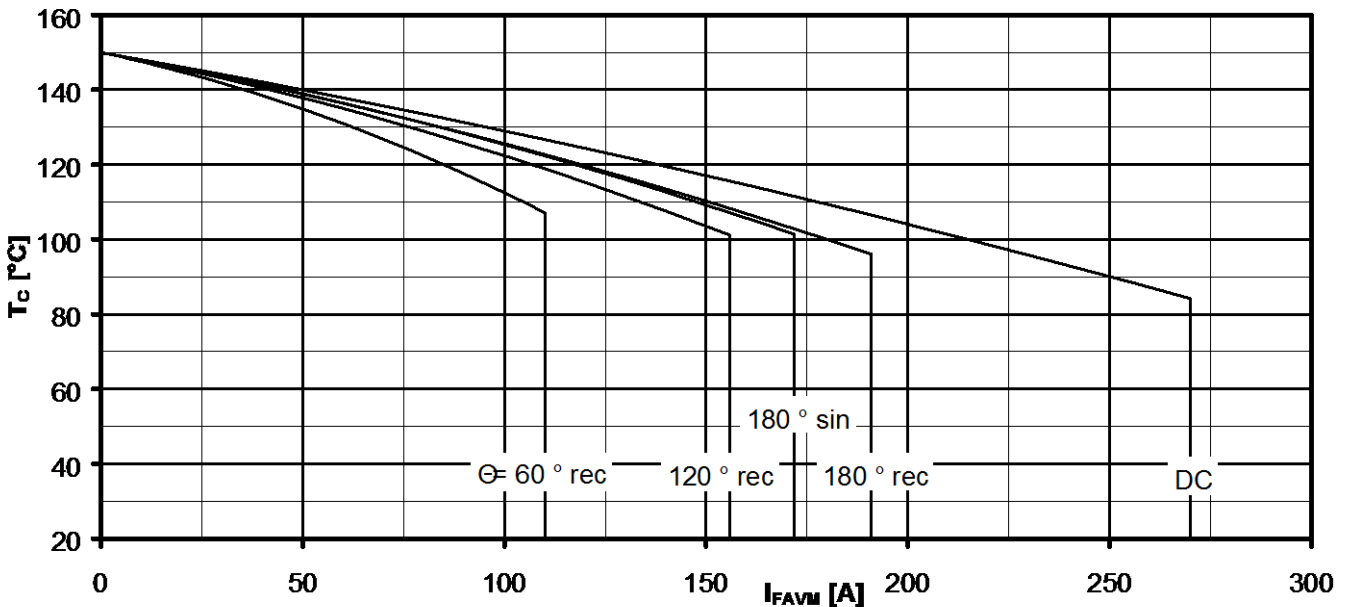

Höchstzulässige Gehäusetemperatur / Maximum allowable case temperature $T_C = f(I_{FAVM})$

Strombelastung je Zweig / Current load per arm

Berechnungsgrundlage P_{TAV}
Calculation base P_{TAV}

Parameter: Stromflußwinkel Θ / Current conduction angle Θ



Netz-Dioden-Modul
Rectifier Diode Module

DD171N

Infineon Technologies Bipolar
GmbH & Co. KG

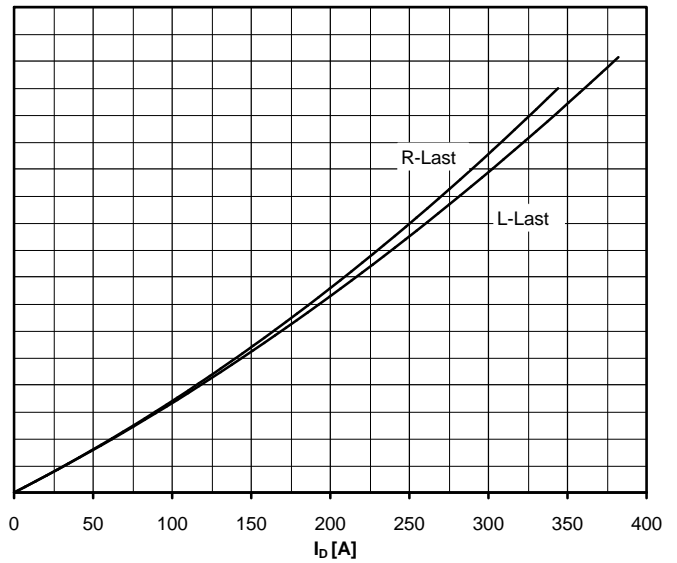
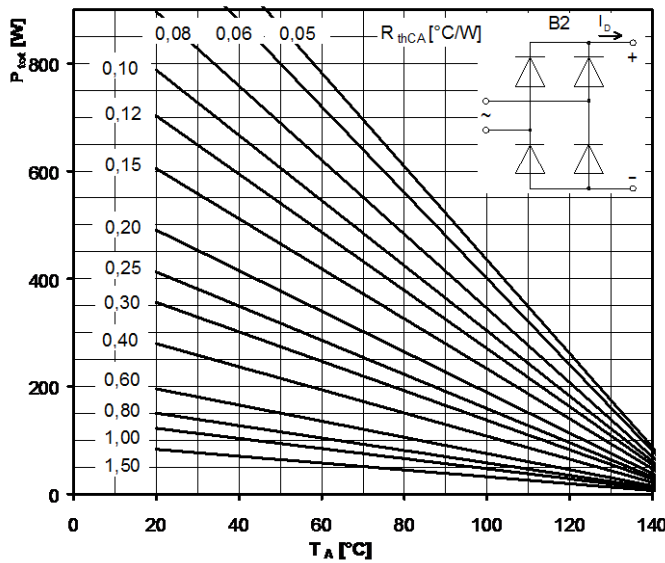

Höchstzulässiger Ausgangsstrom / Maximum rated output current I_D

B2- Zweipuls-Brückenschaltung / Two-pulse bridge circuit

Gesamtverlustleistung der Schaltung / Total power dissipation at circuit P_{tot}

Parameter:

Wärmewiderstand zwischen den Gehäusen und Umgebung / Thermal resistance cases to ambient R_{thCA}

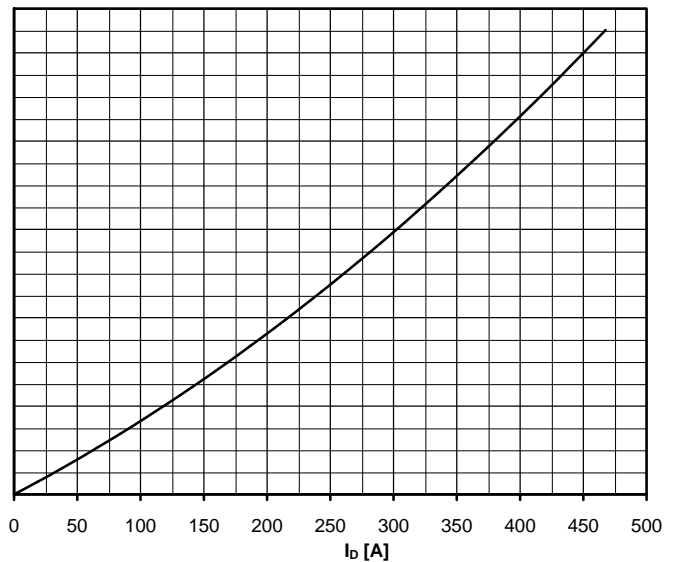
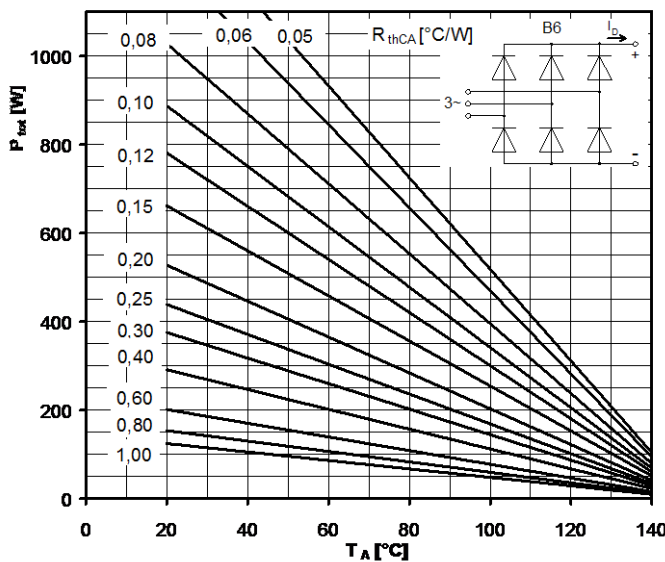

Höchstzulässiger Ausgangsstrom / Maximum rated output current I_D

B6- Sechspuls-Brückenschaltung / Six-pulse bridge circuit

Gesamtverlustleistung der Schaltung / Total power dissipation at circuit P_{tot}

Parameter:

Wärmewiderstand zwischen den Gehäusen und Umgebung / Thermal resistance cases to ambient R_{thCA}

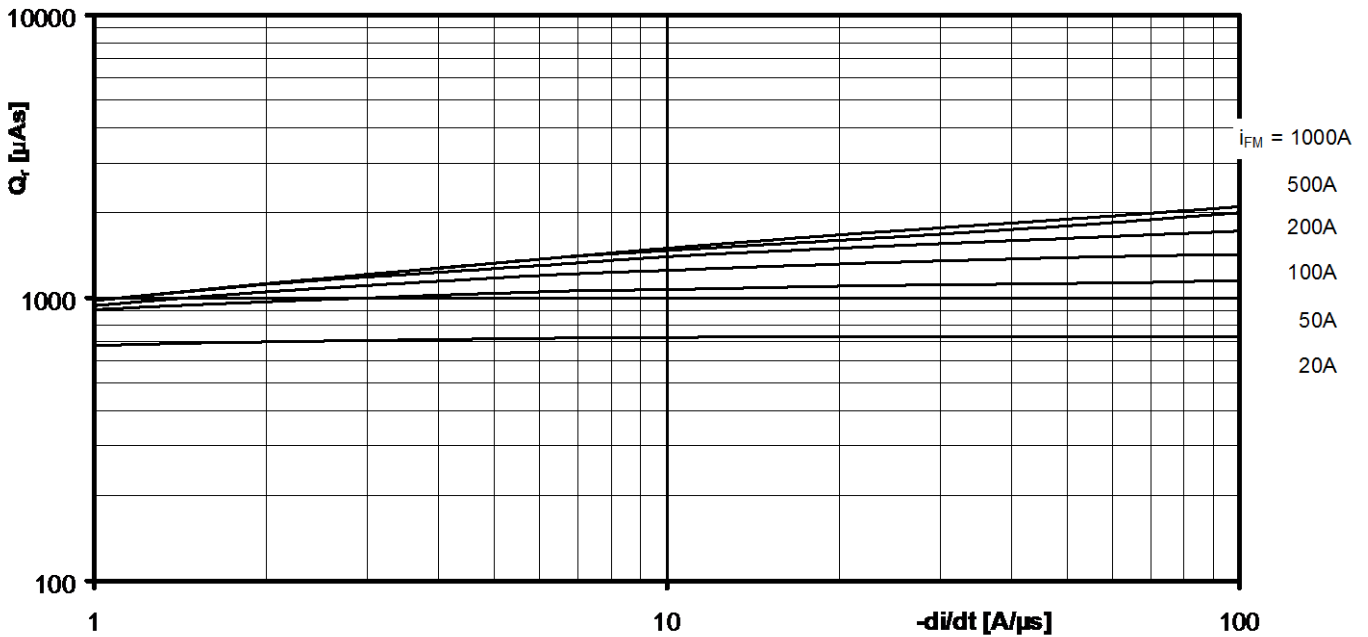

Sperrverzögerungsladung / Recovered charge $Q_r = f(-di/dt)$

$$T_{vj} = T_{vjmax}, V_R \leq 0,5 V_{RRM}, V_{RM} = 0,8 V_{RRM}$$

Parameter: Durchlaßstrom / On-state current i_{FM}

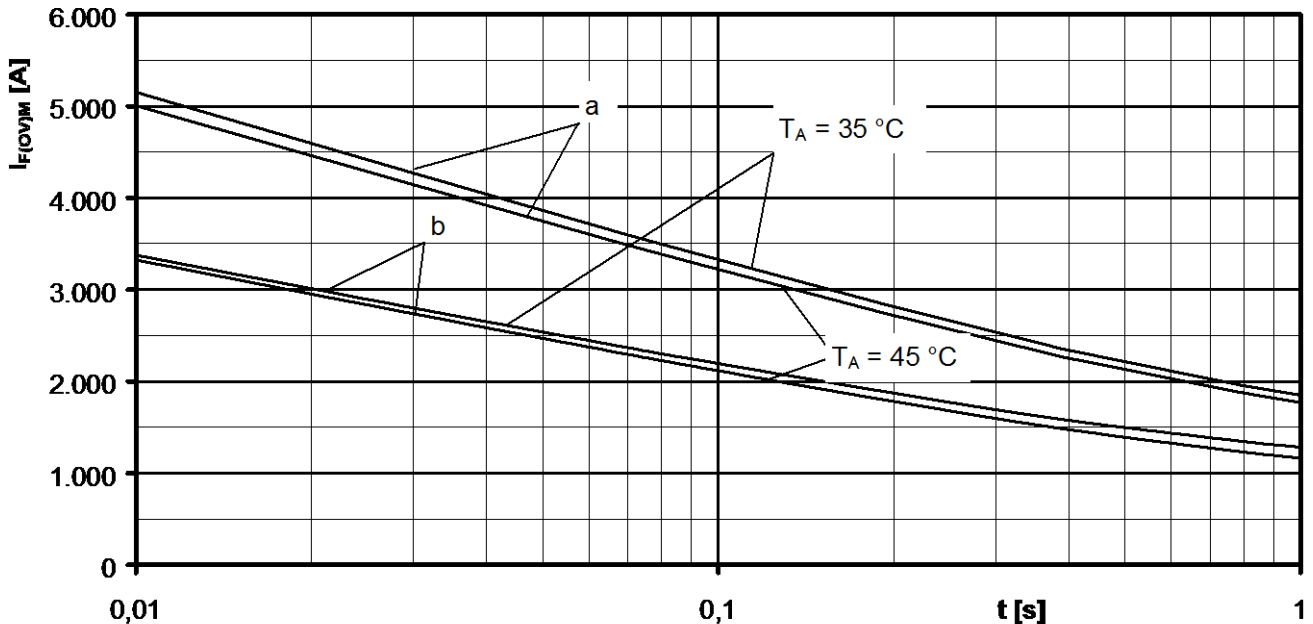

Grenzstrom je Zweig / Maximum overload on-state current per arm $I_{F(OV)M} = f(t), V_{RM} = 0,8 V_{RRM}$

a: Leerlauf / No-load conditions

b: Vorlaststrom je Zweig / Pre-load current per arm $I_{FAV(vor)} = I_{FAVM}$

$T_a = 35^\circ\text{C}$, verstärkte Luftkühlung / Forced air cooling Kühlkörper / Heatsink type: KM17 (Papst 4650)

$T_a = 45^\circ\text{C}$, natürliche Luftkühlung / Natural air cooling Kühlkörper / Heatsink type: KM17 (60W)

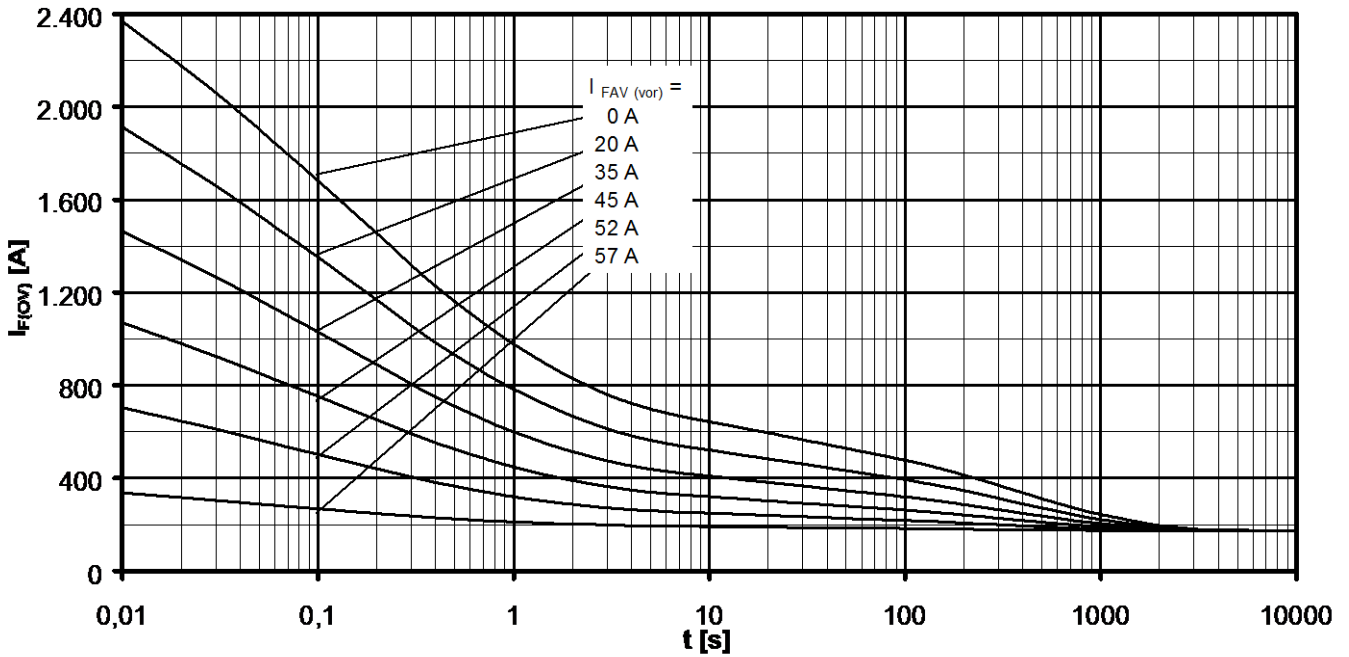

Überstrom je Zweig / Overload on-state current $I_{F(ov)}$

B6- Sechspuls-Brückenschaltung, 120° Rechteck / Six-pulse bridge circuit, 120° rectangular

Kühlkörper / Heatsink type KM17 (60W) Natürliche Kühlung bei / Natural cooling at $T_A = 45^\circ\text{C}$

Parameter: Vorlaststrom je Zweig / Pre-load current per arm $I_{FAV(vor)}$

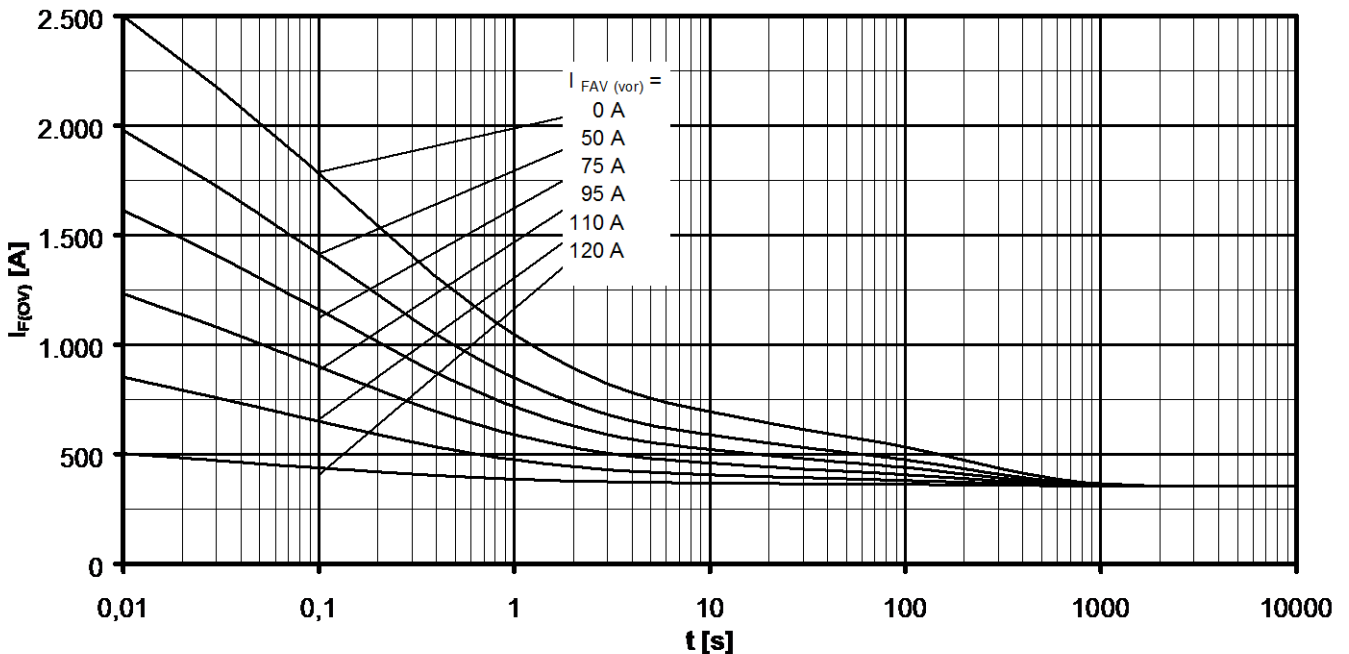

Überstrom je Zweig / Overload on-state current $I_{F(ov)}$

B6- Sechspuls-Brückenschaltung, 120° Rechteck / Six-pulse bridge circuit 120° rectangular

Kühlkörper / Heatsink type KM17 (Papst 4650) Verstärkte Kühlung bei / Forced cooling at $T_A = 35^\circ\text{C}$

Parameter: Vorlaststrom je Zweig / Pre-load current per arm $I_{FAV(vor)}$