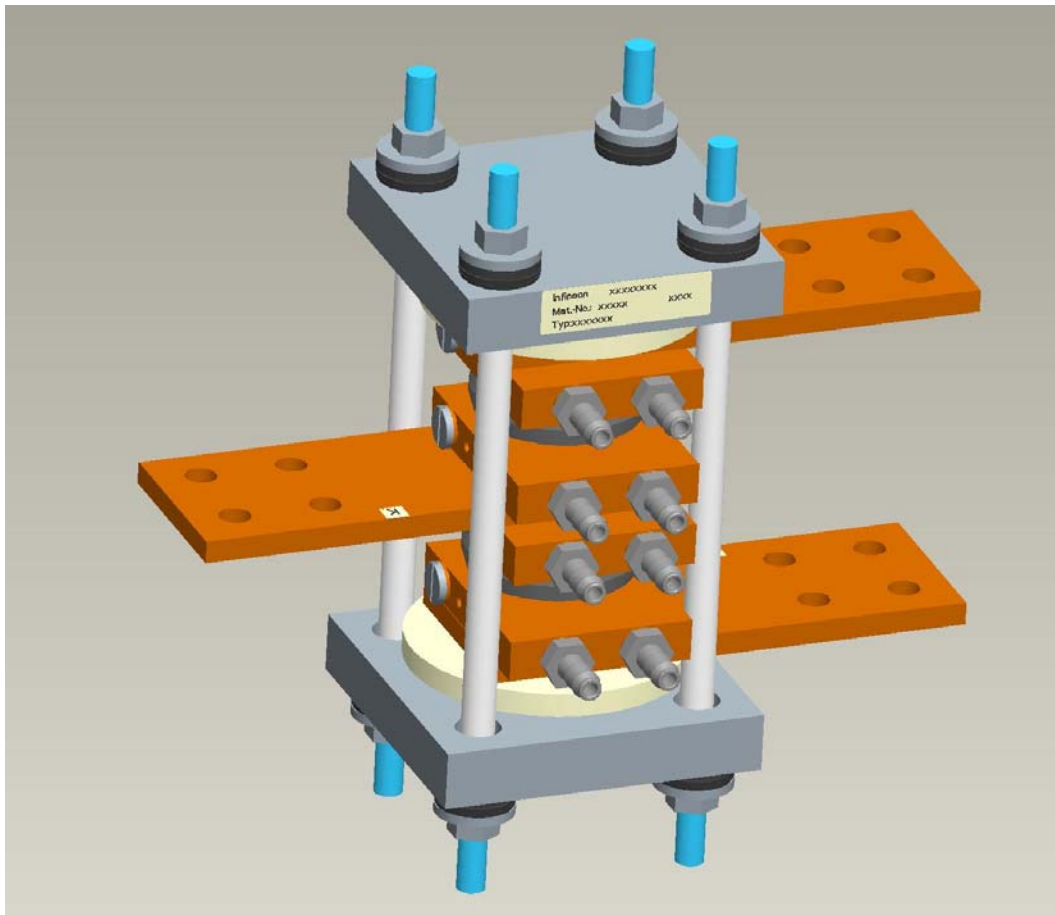


# BipSTACK



## Documentation and Operating Instructions

**Product:** BipSTACK  
**Application:** Rectifiers and AC- Controllers  
**Revision:** Rev. 1.1  
10. March 2009



# CONTENTS

---

1	Introduction .....	4
2	The BipSTACK overview .....	5
2.1	BipSTACK – what is it? .....	5
2.2	Appropriate use .....	6
2.3	Difference: Stack – Block – Component .....	6
3	The BipSTACK in detail .....	7
3.1	BipSTACK Type designation .....	7
3.1.1	Detailed designation according to DIN41762 (old) .....	7
3.1.2	Standardised type designation (New) .....	7
3.1.3	Sales name .....	7
3.2	BipSTACK Datasheet .....	8
3.3	Connection topologies .....	11
3.3.1	B-Circuits .....	11
3.3.2	M-Circuits .....	11
3.3.3	W-Circuits .....	11
3.3.4	Pulsed-Power .....	11
3.4	Mechanical construction .....	11
3.4.1	BipSTACK with semiconductor modules .....	11
3.4.2	BipSTACK with disc cells .....	12
3.4.3	Special notes for water cooling .....	14
3.5	Control and sensors .....	16
3.5.1	Protection against over-voltages .....	16
3.5.2	Temperature switch .....	17
3.5.3	Fuses and fuse monitoring .....	17
3.5.4	Trigger transformer .....	18
4	Selection of the suitable BipSTACK .....	19
4.1	Calculatory basics .....	19
4.1.1	Temperatures .....	19
4.1.2	Frequencies .....	19
4.1.3	Power dissipation (losses) .....	19
4.1.4	Form factor and current load .....	19
4.1.5	Over-voltages, blocking voltage .....	20
4.1.6	Parallel connection .....	20
4.2	Standard BipSTACK-series .....	20
4.3	Request an offer .....	21
4.4	Extent of customer specific BipSTACK offers .....	21
5	Safety notices .....	22
5.1	Transport and storage .....	22
5.1.1	Transport .....	22
5.1.2	Storage .....	22
5.2	Commissioning .....	22

5.2.1	Notes for installation .....	22
5.2.2	Installation and commissioning.....	22
5.3	Maintenance .....	23
5.3.1	General notices for maintenance .....	23
5.3.2	Exchange of fuses.....	23
5.3.3	Exchange of components in air cooled stacks.....	23
5.3.4	Exchange of components in water cooled stacks .....	28
6	Appendix .....	30
6.1	Calculation table for typical circuit types .....	30
6.2	Request for a technical offer .....	32
6.3	Reference table for water cooling .....	37
6.4	Further associated documentation.....	38
6.5	Indices .....	39
6.5.1	Index of terms.....	39
6.5.2	List of figures .....	40
6.6	Conditions of use.....	41
6.7	Contact .....	42

# 1 Introduction

This is the documentation for the BipSTACK product group and it describes this with regard to its technical features. It provides all hints and descriptions relevant to application and selection of the BipSTACK suitable for the application, for the design-in as well as the safe installation and commissioning of the BipSTACKs in their completed version. Further technical information can be found in the datasheet of the individual BipSTACK. This takes precedence over this document.

The documentation begins with the classification of the BipSTACKs within the world of power electronics. Then, building on the technical descriptions and the associated application options, all relevant details in dealing with the product family are described.

Contained are amongst others:

- Description of the various circuits
- Description of the mechanical construction
- Introduction of the protection concepts
- Basics of power rating
- Election of the suitable stacks
- As well as an introduction of other technical descriptions provided by Infineon

Please read this documentation completely before using an Infineon BipSTACK. Only in this way can a flawless application be guaranteed. Also observe all safety notes.

---

Possibly other functions may be available, not described in this document. This fact, however, does not necessitate to provide such functions with a new controller or at the time of maintenance.  
The compliance of the document's contents with the described hardware and software has been checked. Differences may still exist, however; a guarantee for total convergence can not be given. The information contained in this document is reviewed on a regular basis and changes required will be published with the next version. Recommendations for improvement are welcome. The document is subject to change without prior notice.

Reproduction, circulation or use of this document or of its content is permitted only with written authorisation. Contravention will be sued for damages. All rights are reserved including those arising from registered patents, trade names or designs.

## 2 The BipSTACK overview

This section provides an overview over the BipSTACK product family and classifies the product group within power electronics in general.

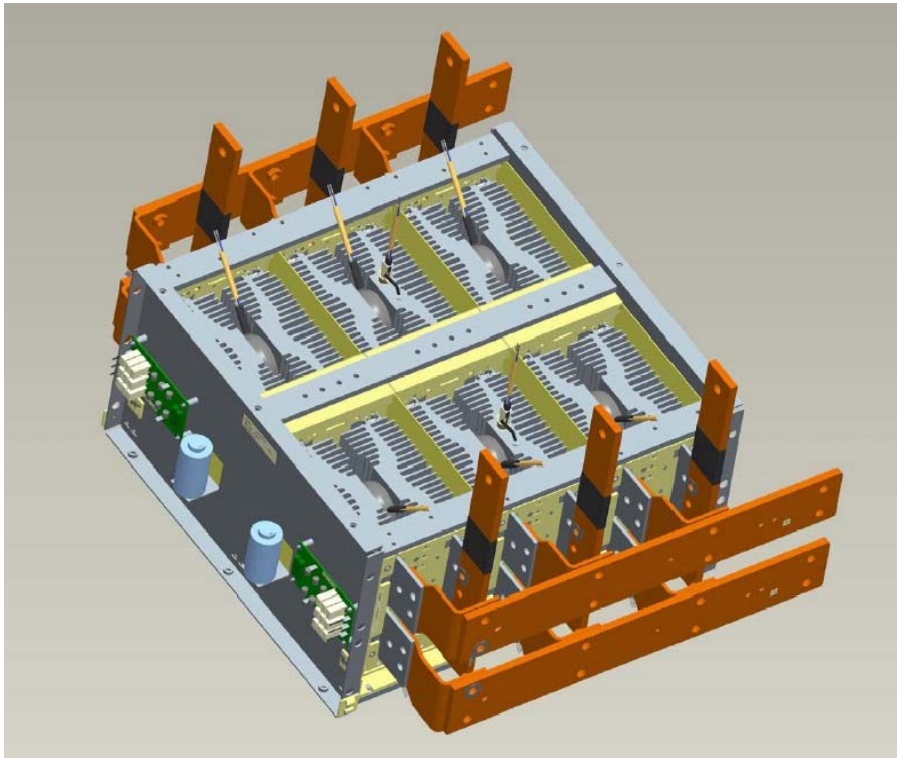
### 2.1 BipSTACK – what is it?

The name of the product group BipSTACK requires some explanation. It has developed historically.

“Bip” stands for bipolar. Diodes and thyristors (SCRs) are part of the bipolar components. Strictly speaking, IGBTs would have to be classified too as bipolar components, the segregation, however, has grown historically and is purely of administrative nature.

The term “Stack” signifies an assembly. This means merging of different components with the aim to prepare one or more semiconductor components for an application. In this way construction or circuitry is provided for measures such as cooling or over-voltage protection during switching.

A BipSTACK consists of a diode or thyristor assembly which is equipped with extras necessary (but not sufficient) for operation.



**Figure 1: Example of a BipSTACK: 2B6C with input protection circuitry and busbars:**  
This assembly consists of 12 thyristors clamped into heatsinks. It is connected in such a way that two independent B6C rectifier circuits result. A circuit input suppressor network each protects from over-voltage. Copper busbars provide the AC and DC connections for the customer application.

## 2.2 Appropriate use

The BipSTACK can be implemented universally. Typical applications are:

- Rectifier in immobile drive systems
- Softstarter
- Wind energy turbine (typically synchronous generators)
- Galvanizing and plating plants
- Pulsed-Power applications (surge voltage systems, generation of high magnetic intensity, linear accelerator...)

The power rating starts at around 100kVA. The upper limit is defined by the maximum size of semiconductor (usually disk cells) as well as the possible parallel connection in the MW range.

The BipSTACK may only be operated within the data and calculation sheet listed in this document and the operating and safety conditions (3.2 BipSTACK Datasheet) explained. Further, mounting and commissioning notes (section Safety notes) are to be observed. For damages resulting from ignoring these, solely the user is responsible.

The electro-technical purpose of BipSTACKs is the explicit rectification or inversion of electrical energy. The currents and voltages arising hereby (depending on application either or, or both) may not be exceeded continuously. Non-observance will jeopardize the operating safety. Only especially trained and instructed personnel may commission, operate and maintain BipSTACKs.

## 2.3 Difference: Stack – Block – Component

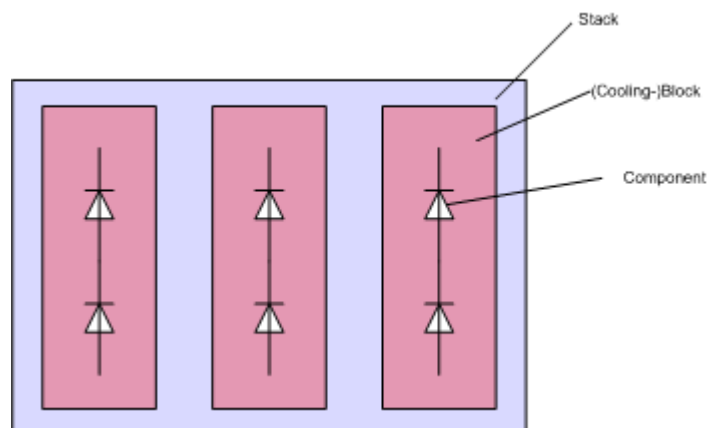


Figure 2: Difference: Stack – Block - Component

If components (diodes, thyristors) are mounted onto a heatsink, the resulting assembly is called a block or also a cooling block. If several cooling blocks are interconnected and clustered to a larger unit and a suppressor circuit wired to it, then this results in a stack. Only stacks will have connection busbars, suppressor networks, fuses and trigger transformers and such like.

### 3 The BipSTACK in detail

This section describes the technical details of the product group BipSTACKs.

#### 3.1 BipSTACK Type designation

Two different type designations are in existence. The one historically developed according to DIN41762, and the new one, based on standardised sizes.

##### 3.1.1 Detailed designation according to DIN41762 (old)

The designation according to DIN41762 is application specific. In the main it is based on the values of the rated operating points regarding current and voltage in continuous operation.

The DIN designation is no longer continued at Infineon. Exclusively the type designation based on standardised sizes will have currency this is a type designation independent of the operating point (see section 3.1.2). However it may happen that at the time of introduction of the new type designation existing stacks the DIN-conform designation is still used (as described further down in the datasheet descriptions).

##### 3.1.2 Standardised type designation (New)

The standardised type designation is independent of the operating point. It describes the BipSTACK with regard to the relevant components. The type designation can be found on the nameplate and the datasheet, but has only informative purpose. In the datasheet DIN41762 is further used to express rated values.

1	2	T	1	3	2	9	N	2	2	K	0	0	8	B	X	X	X		
1	2																		
		T	1	3	2	9	N	2	2										
										K	0	0	8						
														B					
														B					
														W					
														A					
														M					
														V					
														0	0				
														B	0	1			
														B	0	2			
														B	0	3			
														B	0	4			
														B	0	5			
														B	0	6			
																	X		

Number of switches  
 Type designation of switches  
 Heatsink (here K0.08F)  
 Circuit topology  
 B6C/B6U  
 W3C/W1C  
 (B6C)A(B6C)  
 M3/M6/M3.2  
 Block (not stack)  
 Option for standard STACKs  
 SEB (input protection)  
 Snubber (suppressor) circuit  
 Snubber plus cell fuse  
 Snubber plus branch fuse  
 SEB plus cell fuse  
 SEB plus branch fuse  
 Add-Ons for Non-Standard  
 Stacks

##### 3.1.3 Sales name

The sales name is the designation for selling the product and its description, similar to the standardised type designation but without the aid of application parameters. The sales name is relevant for ordering.

1	2	T	1	3	2	9	N	0	0	8	B	2	5	2	6	8	Sales name		
1	2																	Number of components	
		T	1	3	2	9	N											Designation of the components	
								0	0	8								Heatsink (here Ko.08F)	
								0	0	5								K0,05F	
								0	0	2	4							K0,024W	
								K	E	0	1							KE01	
												B						Circuit (here Bx)	
												W						W - circuit	
												A						Anti-parallel connection e.g.	
												M						(B6C)A(B6C)	
												V						M - circuit	
																		Cooling block – no circuit	
														2	5	2	6	8	internal stack ID-number

The possible heatsinks are denoted only exemplarily here.

## 3.2 BipSTACK Datasheet

### 3.2.1.1 Headline

The headline can be found on each page of the datasheet.

#### Technical Information

BipSTACK      B6C 500/670-1860F-K0.08F-6T1509N-LRCx

- Technical information points out that the document is a datasheet. This specifies technical data for the correct use.
  - BipSTACK tells you which product family is concerned. (related product families: ModSTACK™, PrimeSTACK, LightSTACK)
  - Listing of the type designation (see also section: “BipSTACK Type designation”)

### 3.2.1.2 Cover sheet

- Type of the characterised product
- Listing of the various configuration variants of the characterised stack along with the associated SAP number. The datasheet always describes the possible configuration variants.
- Details regarding the circuit topology of the power section (B6C, W1C etc.)
  - Permitted load type
  - Cooling type
  - Possible area of application
  - Supervision / monitoring
  - Semicond. (Unit1): Listing the bipolar semiconductor components (Number of semiconductors) x (Type of semiconductors used)
  - Heatsink
  - Fuse
  - Required trigger pulse for SCRs
  - Which Standards and regulations does the BipSTACK fulfil.



### General information for:

Stack for various rectifier application. Thyristors, heatsink and overvoltage protection circuit included.

#### Types:

#31025: B6C 500/670-1860F-K0.08F-6T1509N-LRC2T (with input snubber bridge) **1**

#31026: B6C 500/670-1860F-K0.08F-6T1509N-LRC1T (with TSE circuit)

#31532: B6C 500/670-1860F-K0.08F-6T1509N-LRC1ST (with TSE circuit and cell fuse) **2**

Topology	B6C
Application / Modulation	Rectifier / Sine
Load type	capacitive
Cooling	forced air (fan included)
Market	t.b.d.
Monitors	t.b.d.
Semicond. (Unit 1)	Thyristor bridge 6 x T1509N16TOF
DC Link	
Semicond. (Unit 2)	t.b.d.
Heat sink	3 x K0.08F
Fuse	optionally included (2 per cell)
Interface Thyristor	electrical
Standards	EN50178
Product ID (eupec)	31025, 31026, 31532
Mechanical drawing number	t.b.d.
Electrical drawing number	t.b.d.

**3**

### 3.2.1.3 Electrical data (Definition according to DIN57558)

#### Electrical data

##### Unit 1 DC

		Maximum value		
Voltage	thyristor control at 0°	$V_{Unit1}$	670	V <b>2</b>
Continuous current	$T_{amb} = 35^{\circ}C$	$I_{Unit1}$	1860	A <b>3</b>
Overload Current	150% for 1min every 10min 200% for 10s every 10min		2175	A <b>4</b>
			2700	A <b>4</b>
Power losses	$I = 1860A$	$P_{loss1}$	4387	W <b>5</b>

##### Unit 1 AC

		Maximum value		
Voltage		$V_{Unit1}$	500	$V_{RMS}$ <b>1</b>
Critical rate of rise of voltage		$(dv/dt)_{cr.1}$	1000	V/ $\mu s$
Critical rate of rise of current		$(di/dt)_{cr.1}$	200	A/ $\mu s$ <b>6</b>
Gate trigger voltage		$V_{GT Unit1}$	2.0	V
Gate trigger current		$I_{GT Unit1}$	250	mA

1. Type connection voltage  
RMS Value of the sine shaped connection voltage. The mains voltage may be exceeded by 10% continuously. Whilst the type rated current of the stack may not be exceeded.
2. Type DC-voltage  
Output DC-voltage (average value) of the controlled rectifier stacks, resulting at type connection voltage, type DC-current and full conduction angle.
3. Type DC-current (for rectifier stacks)  
Maximum average on-state current of the stack. This derived from the maximum

average on-state current of the components and the circuit. The in and outlet of the cooling air may not be obstructed. The maximum average on-state current of the components in controlled stacks is valid at full conduction mode and active load. Controlled rectifiers may be loaded with the type DC-current over the entire control range provided the DC-current is sufficiently filtered.

Type AC-current (with AC-controllers)

Analogously the same applies as for DC-current, however, the type current is given as the RMS value. The AC-controller stacks may be loaded with the type current over a wide area of conduction angle.

4. Permitted current load during cases of overload. The listed current value does not lead to an exceedance of the maximum permitted junction temperature.
5. Power loss at rated operating point. Included in the calculation are only the on-state losses; no switching losses (see also section 4.1 *Calculative basics*)
6. Permitted component data of the semiconductors used.

### 3.2.1.4 Cooling

Heat sink air cooled / Thermal data		min	typ	max	units
Cooling air inlet temperature	$T_{inlet} > 35^{\circ}\text{C}$ derating necessary		35		$^{\circ}\text{C}$
Thermal resistance junction to ambient		$R_{thja}$ Thyristor		0,12	K/W

Two basically different heatsinks exist: air cooled and water cooled. Depending on the cooling method used for the BipSTACK, only one of the heatsinks and datasheet blocks will appear.

1. Permissible (air or water) inlet temperatures at which, when they are exceeded, a current derating has to be calculated. Additional specification of the  $R_{thja}$  (Junction – Ambient) of a thyristor (single switch).

### 3.2.1.5 Options (add-ons)

AddOn		min	typ	max	units
Thermo switch	normal close	$T_{Switch}$	95		$^{\circ}\text{C}$
Fuse	Type 700A (690V)				
Fan (3x)	230V. 50Hz				

Listing of the snubber and protective circuits integrated into the stack with their individually most important characteristic values. Examples are:

1. - Temperature switches (normally closed or normally open)
  - fuses
  - fans

### 3.3 Connection topologies

The following describes the most important circuit topologies offered by Infineon BipSTACK. Further down and in the addendum you will find additional information, particularly key figures and parameters.

#### 3.3.1 B-Circuits

B-Circuit (e.g. B2U, B6U, B6C) are bridges for rectification of AC. They are used the most in rectifier applications as they require the least transformer power of all circuit types. Alternatively B6C-circuits alone or in anti-parallel configuration (B6C)A(B6C) may also be used in an inverter operation.

#### 3.3.2 M-Circuits

M-Circuits (e.g. M3U, M3C) are center-tap circuits for rectification of AC. They are much less commonly used in applications than B-circuits and are operated mainly with lower input voltages.

#### 3.3.3 W-Circuits

W-Circuits (e.g. W1C, W3C) are AC controllers to set the RMS value of the AC component according to the requirements of the application or to switch short-term over-currents electronically. Typical applications are Softstarters for drive systems.

#### 3.3.4 Pulsed-Power

Pulsed-Power circuits may not be grouped to any other category. Their purpose is to provide a current or voltage pulse of great intensity, typically in the two or three digit kA or kV range.

### 3.4 Mechanical construction

The mechanical construction of BipSTACK can be coarsely categorised into two groups, BipSTACKs with semiconductor *modules* for application in the lower voltage and current range, and BipSTACKs with disc cells for applications in the range of low to higher voltages in the medium to high power sector, up to extreme limits such as pulsed power applications.

Within the two major groups it can be further separated into air, water and oil cooling. In the end the application will determine the component to be used and this in turn requires an adequate heatsink. The heatsink portfolio is listed in the following.

#### 3.4.1 BipSTACK with semiconductor modules

Semiconductor modules are packages with terminals to connect electrically the adjoining circuitry, and a baseplate to thermally contact the semiconductor. Terminals and baseplate are electrically isolated from each other. Therefore the electrical potential of the heatsink is independent of the module power terminals within the limits as stated as permitted in the insulation co-ordination.

BipSTACKs with modules are positioned in the lower three digit kW-range. With good cooling not the semiconductor itself limits the power rather than the internal construction of the modules limits the power through the maximum RMS on-state current. Above this current (at sufficiently good cooling) the module package creates that much power losses that a heat transfer back into the chip occurs.

### 3.4.1.1 Modules – Air cooling

- KM10
  - For a single module
- KM11, KM14, KM17, KM18
  - Heatsinks with the same profile but different lengths
  - Standard
  - Modules with baseplate width
    - 20 - 50mm → mounted across
    - 60 and 70mm → mounted longitudinally

### 3.4.1.2 Modules – water cooling

With closed cooling channels beneath the modules Using the through-hole technique modules can be mounted on both sides.

- KW50, KW60, KW70
  - 50, 60 and 70 describes the module width in mm
  - Open water cooling, i.e. only the module baseplate seals the water circuit, once it is mounted onto the heatsink.
- KW30, KW61, KW65
  - As with KW50, 60, 70, but with closed cooler plate
  - Utilising through-holes so modules can be mounted on both sides.

### 3.4.2 BipSTACK with disc cells

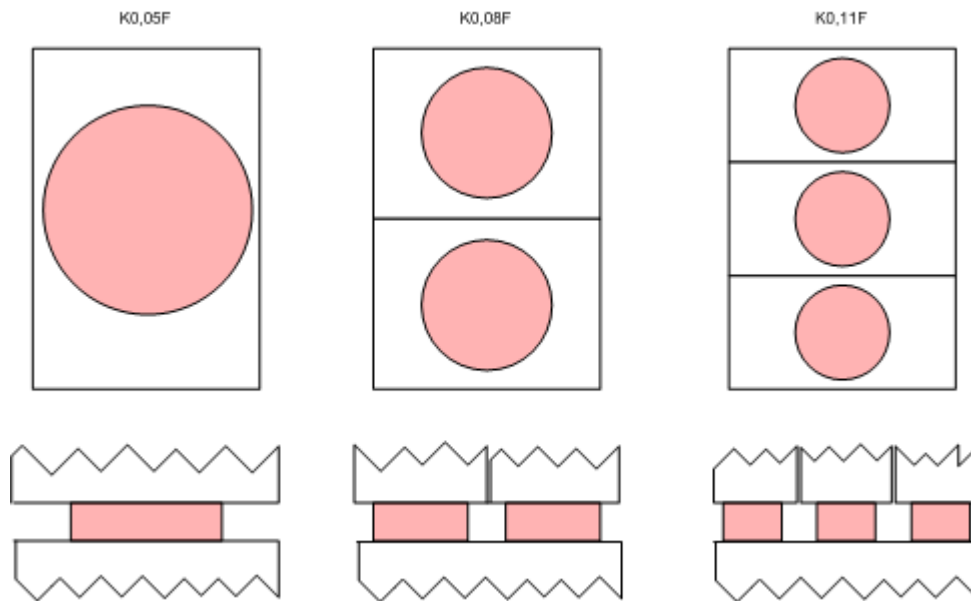
Disc cells have a double sided contact. They are mounted between two heatsink halves. Depending on the type of heatsink and the size of the disc cell several semiconductor components may be placed in a cooler heatsink.

#### 3.4.2.1 Discs – Air and water cooling

All stacks for air cooling may also be used for oil cooling. The  $R_{th}$  achieved with oil cooling equals that of forced air cooling. The use of additional (snubber) circuitry has to be checked in each individual case, however.

#### Forced Air cooling

- General
  - Standard fan is W2S130 if not otherwise specified.
  - The naming of most of the air coolers for disc cells is based on the achievable  $R_{th\ C-A}$
- K0,05F, K0,08F, K0,11F
  - For components 50 – 74mm diameter.
  - Cooler for mains applications
  - One standard fan per block
  - Standard for forced cooling, but also suitable for convection cooling
  - Denomination for higher voltages:
    - “... .7” more creepage (e.g.: K0,08.7F)
  - Outside dimensions of the blocks identical



**Figure 3: Conceptual illustration of the Kx cooler family. Up to 3 discs are mounted onto one heatsink half. The number of disc cells determines the number of heatsink counterparts and so defines the  $R_{th}$ , which in turn provides the basis for the name.**

- K0,048F
  - For components 100 – 120mm diameter.
  - Similar to K0,05F
  - But other heatsink profile, so larger discs can be mounted
- K0,12F, K0,17F, K0,22F
  - For components 41 – 60mm diameter.
  - similar to the K0.05 series
  - lower priced due to lower weight
  - but higher  $R_{th\ C-A}$  at the same time
  - For slim components with height up to 14mm
    - K0.12: One component
    - K0.17: two components side by side
    - K0.22: two components on top of each other, separated by 4mm aluminium sheet
- KE01, KE02
  - For components 100 – 150mm diameter.
  - Standard fan W2E200
    - KE01: 1 component up to 150mm
    - KE02: 2 components up to 120mm
  - Not suitable for 172mm cells

### Convection cooling

- General
  - Especially suitable for short term operation.
  - Short term operation = time wise between pulsed power operation and transient times during which the heat capacity of the cooler is not filled.
  - Characteristically: massive block directly on disc means high heat capacity
- K0,2S

- For components 57 – 75mm diameter.
- Dimensions similar to K0,05F, however, with optimised rib-structure for convection cooling
- K0,18S
  - For components 100 – 120mm diameter.
  - Like K0,048F compared to K0,05F
  - Profile like milled out K0.2S version
  - Ideal for railway supply applications
- K0,36S and K0,65S
  - Similar to K0.22F for 2 cells on top of each other, but for convection cooling
  - For components 41 – 60mm diameter.
- K0,92S
  - For components 57 – 75mm diameter.
  - Similar to K0,08F
  - Especially suitable for short term operation.
  - Example: wind power turbines, to couple over-currents to the grid during start-up of the synchronous generators

### 3.4.2.2 Discs – water cooling

Note: Stacks with water cooling are generally built without snubbing.

- KA20, KC20, KD20
  - For components 41 – 60mm diameter.
  - Water cooler capsule with integrated connection terminal
  - Compact design
  - Difference in naming: number of cooling capsules per block
- K53, K63, K84
  - For components 100 – 172mm diameter.
  - With connection terminal bars in different varieties.
  - K53
    - Discs with a diameter 110 and 120mm
  - K63
    - Discs with a diameter 150mm
  - K84
    - Discs with a diameter 172mm
- K0,024W
  - Up to 75mm disc diameter
  - the cooling capsule with V-hole is not isolated
  - Possibilities of insulation:
    - Iso-disc (Significantly increased Rth) or with so called “ISO” blocks! Caution likelihood of confusion!
    - Open isolation with AlN-discs (only up to 70V!) Coding “I”

### 3.4.3 Special notes for water cooling

Higher power losses may economically only be dissipated using water cooling blocks.

Water cooling shows the following **advantages** over forced air cooling:

- less semiconductor components, as they may be used to a higher current.
- no costly air-water coolers and air filters in closed circuit systems.

- no noise pollution due to fan noise
- no treatment of cooling air necessary if the atmosphere is aggressive or dirty

On the other side the following **disadvantages** exist:

- low overload capability of the components, as a high base load is already prevalent with water cooling
- if the water quality is poor, often a separate water circuit with heat exchanger is necessary
- Water connections, hose connections, water flow control and temperature monitoring for the cooling capsules

According to DIN50930 high requirements are placed on the water quality in water cooling, which in practical operation are not always possible to adhere to. It has therefore to be checked which deviations are permissible without jeopardising the operational safety.

In the addendum (section 6.3 “*Note-table for water cooling*”) different water types are appraised, such as totally desalinated water, distilled water, monitored boiler-feed water and general process water. The operating mode and the material of the cooling capsule with nipple decide which water quality may be suitable for the system. The water quantity depends on the cooling block and is in the magnitude of 2-10 l/min. With this cooling water quantity it needs to be taken care of the hose diameter, in order to stay within around 2m/s flow velocity. Higher flow velocities may contribute to the corrosion and material degradation. The flow quantity may be checked with a flow monitor. The hose length between two heatsink potentials depends on the voltage difference and the electric conductivity of the water. One formula with which the hose length may be estimated is as follows:

$$L_S \approx k \cdot U_D \cdot Q$$

where:

$L_S$  = hose length in mm

k = constant

0.8 for systems with heat exchanger (re-cooling)

1.4 for systems with fresh water

$U_D$  = DC-voltage in V

Q = hose cross section in  $\text{cm}^2$

For normal industrial applications Parker clip-connection hoses can be recommended. The water temperature may be monitored with a contact thermometer or with a thermo-switch at the cooling capsule. The water temperature lift may be calculated with via the dissipated power loss with the following formula:

$$\Delta T [^\circ\text{C}] = \frac{P[W] \cdot 14,3 \cdot 10^{-3}}{v_L [l / \text{min}]}$$

where:

P = dissipated power loss

$v_L$  = water quantity per one component

Water cooling is almost inevitably associated with electrolytic material degradation. In these cases systems where AC is switched are less critical than rectifiers. The material degradation

becomes more critical with increased conductivity of the water and the magnitude of the electrolytic current. When using demineralised water it needs to be considered that no brass parts may be used in the water path. Due to the dissolving of zinc portions occurrence of damage is likely. Critical applications with water cooling may be mitigated by a potential free water circuit. For this, Infineon offers a complete programme of insulation discs on request. Infineon insulation discs feature an excellent heat conductivity and a high breakdown voltage. For insulation purposes environmentally friendly aluminium-nitrite is used. We recommend to use ISO-discs where-ever high DC voltages in combination with poor water quality are being used.

## 3.5 Control and sensors

### 3.5.1 Protection against over-voltages

Snubber circuits serve to protect semiconductor components against over-voltages. Basically it is differentiated between input protection (SEB) and partial circuit surge suppression (TSE).

Protection circuitry is optional equipment and needs to be ordered explicitly, unless they are already integrated into the stack (standard BipSTACKs in particular). The latter can be recognised by the stack type designation.

For the design criteria of the snubbers the following is presumed:

- Nominal operating conditions according to DIN57558
- The type nominal power of the rectifier transformer equals approximately that of the connected rectifier stack. Here the short circuit impedance voltage  $u_K$  of the transformer incl. grid is approximately 4%.
- For AC-controllers the snubber circuit is set approximately to one load circuit with a phase angle of  $\varphi \leq 30^\circ$  ( $\cos \varphi \geq 0,866$ ).

#### 3.5.1.1 Snubber - partial circuit surge suppression (TSE)

Partial circuit surge suppressions (TSE) are dependent on the components. Each semiconductor component in the BipSTACK has its own snubber. Partial circuit surge suppression (TSE) are RC-networks, connected in parallel to the semiconductor. The selection of the partial circuit surge suppression is done according to the semiconductor specific parameters:

- Blocking voltage  $V_{RRM}$
- Commutation voltage (see datasheet. Typically based on main voltage)
- Reverse recovery charge  $Q_R$

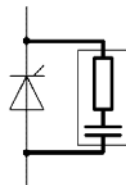


Figure 4: Partial circuit surge suppression (TSE)

#### 3.5.1.2 Input protection

Input protection (SEB) depends on the stack. It exists once per three-phase assembly. As the name suggests, they are connected to the AC power terminals of a rectifier.



It consists of an auxiliary rectifier circuit (B6U) connected to the three-phase input, charging into a capacitor. It is connected between the actual rectifier and the mains and suppresses over-voltages, related to nominal operation, into a capacitor. This in turn is permanently discharged by a resistor in parallel, to be ready for the next voltage pulse.

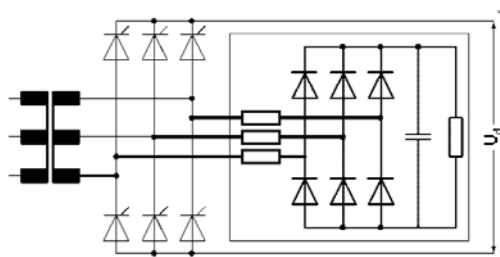


Figure 5: Input protection (SEB)

### 3.5.2 Temperature switch

Temperature switches serve to monitor the fan. These are temperature sensors which when a certain pre-set temperature threshold has been reached, will close an electrical auxiliary circuit if the switch is “normally open” or conversely open the circuit if the switch is “normally closed”. The terminals of the circuit are made available to the user and can be used to trigger an action. An actual temperature value is not given.

The temperature threshold is selected stack specific. The temp. switch is only used with forced air cooling, and with water cooling perhaps as water flow check. It serves to prevent a thermal overload of the semiconductor during low load operation without fan (e.g.: after its failure). By opening or closing of the circuit the user receives a notification only that (with little headroom) should the temperature of the semiconductor or the entire BipSTACK rise, the specification will be infringed.

Temperature switches are positioned directly onto the heatsink or near the component. They comply with the requirements for the individual insulation co-ordination and are tested accordingly. Temperature switches are optional equipment and needs to be ordered explicitly, unless they are already integrated into the stack (BipSTACKs with forced cooling in particular).

### 3.5.3 Fuses and fuse monitoring.

Fuses serve to protect the BipSTACK in case of a short circuit. These are semiconductor rated fuses.

It is differentiated between branch fuses and cell fuses. Branch fuses protect the relevant half-bridge. They are looped directly into the AC-connection and are typically used with BipSTACKs with modules. They do not protect from internal short circuit.

Cell fuses, instead, are connected directly to the semiconductor component. They are used mainly with disc cells. Depending on the nominal current but also according to application specific parameters up to two fuses per cell may be connected in parallel.

Vital design criteria:

- The arc voltage of the fuse does not exceed the maximum permissible peak reverse voltage of the components.

- The components are loaded with nominal current during permanent operation
- The short circuit impedance voltage of the feeding mains or transformer is  $u_K \geq 2\%$  relative to the point of coupling, nominal voltage and current of the stack.
- Correction factors (e.g.: ambient temperature)

Fuses are optional equipment and needs to be ordered explicitly, unless they are already integrated into the stack (in standard BipSTACKs in particular).

Fused disc stacks are generally equipped with fuse monitoring. The indicator triggers the mounted micro-switch via a mechanical monitoring set.

#### Fuses with inverter operation

With disc cell stacks in B6C- and (B6C)A(B6C) topology rectifier operation with phase angles  $> 90^\circ$  is possible. During failures in this operating mode the turn-off voltage may rise to the 1.8 fold of the feeding voltage. Therefore catalogued fuses with nominal voltages of 690V may only be used for a feed voltage of 400V.

For stacks with 500V and 690V feed voltage we recommend to use the fuses with the following nominal voltages in rectifier mode:

Feed voltage	Fuse voltage
500V	$\geq 900V$
690V	$\geq 1250V$

The power loss of the fuses is not shown in the power loss calculation of the stack.

### **3.5.4 Trigger transformer**

Trigger transformers are used in thyristor stacks. Their purpose is the galvanic separation of the thyristor gate from the driver in order to enable a potential free firing control.

Trigger transformers are always optional supplies and have to be ordered explicitly.

## 4 Selection of the suitable BipSTACK

The user is able to select the suitable stack largely himself. This section serves this purpose. It is described which data are necessary as a basis for a design and which technical supplementary conditions are relevant.

### 4.1 Calculatory basics

#### 4.1.1 Temperatures

If not otherwise specified or required by the customer, standard values are used to calculate. The following standard temperatures are valid for the cooling medium at the inlet point of the heatsink ( $T_{inlet}$ )

- Convection cooling (“S”) → 45°C
- Forced Air cooling (“F”) → 35°C
- Water cooling (“W”) → 25°C @ 4 l/min

The nominal current of the BipSTACK mentioned in the datasheet and in the type designation relates back to the  $T_{inlet}$ .

#### 4.1.2 Frequencies

It is not differentiated between 50Hz and 60Hz applications. These are the typical application frequencies used in mains connections. Only in the area of ship building frequencies of 400Hz are calculated with for historical reasons. In those cases the switching losses have to be considered in addition to the conduction losses.

#### 4.1.3 Power dissipation (losses)

Via the construction related thermal resistance power dissipation losses cause heat. To limit the calculation work when selecting a stack and in consideration of the negligible switching losses, only the conduction losses are taken for the calculation of junction and case temperatures.

Approximation means that only conduction losses are relevant. These are calculated using the equivalent line approximation (current, contact resistance, threshold voltage).

Permissible area for simplified determination of the maximum temperatures:

- Typical mains frequencies (50...60Hz)
- Actually occurring blocking voltages <2kV or mains voltages <690V

If the permitted area is exceeded, the turn-off losses too need to be considered. These consist in the main of the storage charge to be dispersed.

#### 4.1.4 Form factor and current load

A bipolar component carries a current for a variable time. The form factor is the relation between the RMS value and the rectified average value of the current through the component.

The form factor can be calculated. Important: Calculations done by Infineon always presume ideal conditions, i.e.: valid is a 120° square wave current loading the component of a B6x. Thus results in a form factor of 1.73, building the basis for further calculations.

Drastic variations from the ideal values on behalf of the customer have to be considered regarding the circuitry. For example a contactor controlled charge resistor for the DC-bus to limit the load current.

This approach assures the comparability between stacks and is still sufficiently precise.

#### **4.1.5 Over-voltages, blocking voltage**

Over-voltages may be buffered using the snubber (TSE) or input protective circuitry (SEB) described above and hence reduced for the semiconductor. Typically one or the other is used. In some exceptions both may be used.

The losses produced in the snubber or protective networks are not considered in the loss calculation and not shown in the datasheet. The reason is that if the snubber is designed correctly the heat management is sufficient and the losses are negligible.

#### **4.1.6 Parallel connection**

When paralleling components the following current derating is recommended:

- 10% when fuses are placed in series with the semiconductors
- 20% for hard parallel
- 30% for modules, whilst paralleling of modules is generally not recommended!

## **4.2 Standard BipSTACK-series**

The type range of BipSTACKs is extremely wide due to the possibility to combine components with heatsinks and additional circuits. The standard BipSTACKs serve to give reference points which combinations of heatsinks, semiconductors and additional circuitry is sensible for the different power ranges and typical applications.

The most widely used rectifier and AC-controller circuits B6U, B6C and W1C or W3C are covered.

The standard Bip-STACK series is limited to air-cooled stacks and blocks. The reason is the intensely application specific variation of water-cooled BipSTACKs. A standardisation is not possible. Enquiries for water-cooled systems will require a custom specific design.

The standard BipSTACK series features the following characteristics:

- 2 voltage classes 500V and 690V mains
- Range steps according to current only within a voltage class
- T (temperature switch) standard with forced air-cooling
- L (fan) standard for stacks with forced air-cooling
- Optional circuitry in limited combination
  - RC1-snubber (TSE)
  - RC2-Input protection (SEB)
  - S (fuses)
- No bus-bars of the AC or DC side (except the mounting of the optional fuses)

Information regarding the standard BipSTACKs may be found in the following sources:

- This product documentation
- The datasheet (available in the Internet)
- The short form catalogue (available in the Internet)

### 4.3 Request an offer

A suitable standard BipSTACK may be chosen autonomously for typical rectifiers and AC-controllers when entering the most important data. If the requirements exceed this, the data serve to request and calculate a customer specific offer. The required data can be found in section 6.2.

The calculation of a technical offer by Infineon can usually be handled rapidly and without the need for queries when the offer request sheet is filled in completely. The “**Checklist for Bipolar Assemblies**” can be downloaded from the Internet. It is also contained in the addendum of section 6.2 “*Request for a technical offer*”. To request the offer, it can be printed out, filled in and sent to the sales representative for your area (see short form catalogue or Internet). Alternatively it may be sent directly to:

- [info@infineon.com](mailto:info@infineon.com) (email)
- 0049 (0) 2902 764 1102 (fax)

### 4.4 Extent of customer specific BipSTACK offers

If the features of the standard BipSTACKs do not match the requirements, customer specific solutions can be compiled. The extent of the offer depends in this case on the application and the customer’s requirements. It is based on the idea to work without the creation of a datasheet and to be able to rapidly implement requested changes to the (technical) offer.

Typical extent of an offer is:

- Calculation sheet for continuous operation
- Dimensional drawing of a comparable product

Depending on application and customer request further information may be added:

- Calculation sheet for short term operation (based on the duty cycle specification by the customer).

## 5 Safety notices

### 5.1 Transport and storage

#### 5.1.1 Transport

- Min. transport temperature:  $- 30^{\circ}\text{C}$
- Relative humidity:  $\leq 95 \%$
- Max. transport temperature  $+ 70^{\circ}\text{C}$
- Normal loading on board, transport on good roads, no free fall, occasional stroke up to 10 g max. acceleration permitted.
- Truck or railway transport according to the usual transport requirements

#### 5.1.2 Storage

- Lower storage temperature  $- 30^{\circ}\text{C}$
- Upper storage temperature  $+ 70^{\circ}\text{C}$
- Relative humidity:  $\leq 95 \%$
- Packaging in cardboard carton, mounted on pallet
- Permissible heat radiation
- Low air movement 5m/s
- Usual industrial area
- Storage not near sand and dust sources
- Storage in non-aggressive atmosphere
- Storage with just noticeable but low vibrations and strokes, for example through passing traffic
- Storage time: max. 1a

### 5.2 Commissioning

#### 5.2.1 Notes for installation

Employment of the BipSTACK would typically be inside switchboard cabinets. The BipSTACKs are to be integrated into the protection measures of the entire system.

When installing a BipSTACK the following has to be taken into account:

- The operation of the BipSTACK is only permitted within the defined conditions of the valid documents (datasheet, this documentation...).
- For air convection cooling it is necessary to mount the BipStack vertically in order to have the air pass unobstructed through the heatsink.
- Aeration of the switchboards has to be arranged such that the quoted power losses may be dispersed safely.
- Max. altitude 1000m. When operating above that level a current/voltage derating is recommended

#### 5.2.2 Installation and commissioning

- The power cables are to be strain relieved in order to have no force exerted onto the construction of the BipSTACK.

The connection points have to guarantee safe contact.

BipSTACKs are subject to a 100% production test. When commissioning a BipSTACK it is recommended to carry out the following additional checks:

1. Visual check of:
  - Observance of the mounting and cooling conditions (see above)
  - Transport damage
  - Foreign bodies in the stack
  - Proper and correct connection (see above)
  - Integration of the BipSTACK into the protection measures of the entire system
2. Measuring the insulation resistance
  - of the BipSTACK mounted in the switchboard according to EN50178 or IEC61800.

## 5.3 Maintenance

### 5.3.1 General notices for maintenance

The components inside the stacks are non-moving and hence virtually maintenance free. Due to the open construction the isolation tracks are not protected from humidity and dust. In an intensely dusty area the components and heatsinks are to be cleaned from time to time in order not to degrade the insulation capability and heat dispersion.

### 5.3.2 Exchange of fuses

When exchanging fuses, care has to be taken that under no circumstances arbitrary fuses are used. Instead only the originally supplied or technically comparable with equal fusing characteristics and equal overall turn-off integral must be used.

### 5.3.3 Exchange of components in air cooled stacks

We do not recommend to exchange components in disc cell stacks yourself. Appropriate mounting can normally only be achieved with a special jig. If a component change on-site can not be avoided, continue as follows:

- Removal of the component by alternating loosening of the clamping bolts
- Cleaning of the contact surfaces of heatsink and component. Apply contact surfaces with fresh heat transfer compound (approx. 100µm). That may be done with a rubber roller.
- Arrange and centre components, equivalent to the original stacking
- Turn nuts of the clamping bolts carefully by hand until the clamping parts have just closed force.
- Check position of the components and arrange if necessary.
- Adjust clamping force according to the datasheet of the related semiconductor component with the aid of Figure 6 **Fehler! Verweisquelle konnte nicht gefunden werden.**and Figure 7.
- Re-attach the mounting sheets to the heatsinks

These instructions should only be used in exceptional circumstances We point out (warn) that in case of such a manual assembly impermissible side forces may occur.

## Setting the clamping force

1.) Determining the clamping force  $F_S$ :

$$F_S = 0.8 F_{\max}$$

if  $F_S > F_{SK}$ ,  
then  $F_S = F_{SK}$

$F_S$  = requires clamping force for diode / thyristor in the heatsink

$F_{\max}$  = max. clamping force for diode / thyristor according to table xx

$F_{SK}$  = max. clamping force of the spring packet

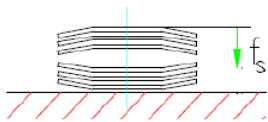
$f_S$  = travel of the spring packet

2.) Determining the travel of the spring packet

2.1) Compare existing spring layers with layers 1-8

2.2) Read travel 1-8 in the diagram

3.) Set travel  $f_S$  by several alternating tightening



Per nut turn the following spring travel occurs:

- thread M6:  $s = 1\text{mm}$

- thread M8:  $s = 1.25\text{mm}$

Number of nut turns =  $f_S : \text{pitch } s$

Spring travel should be determined and checked resulting from the difference between column height clamped and column height unclamped (0-set point) with appropriate vernier callipers.

Example:

Spring travel  $f_S = 1.4\text{mm}$

Thread M8:  $s = 1.25\text{mm}$

Number of nut turns:

$1.4\text{mm} : 1.25\text{mm} = 1.12$  turns

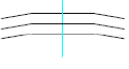
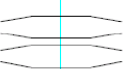

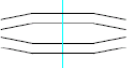

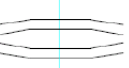


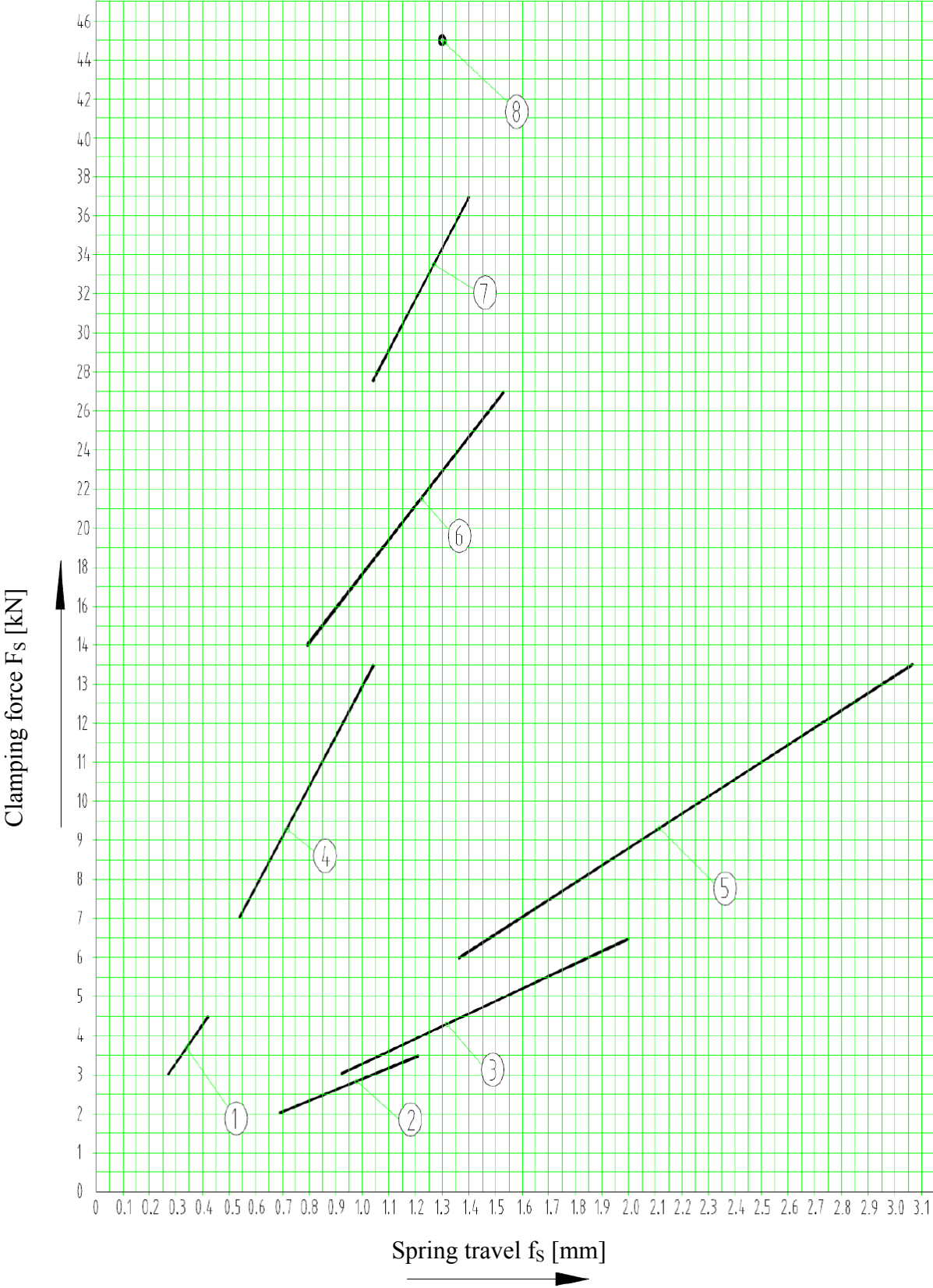
<p><b>1</b></p> <p><math>F_{SK} = 4.5\text{kN}</math></p> <p>2 spring columns per component with 3 springs each</p>  <p>spring column    Belleville spring washer    18x6.2x0.8</p>	<p><b>2</b></p> <p><math>F_{SK} = 3.5\text{kN}</math></p> <p>2 spring columns per component with 4 springs each</p>  <p>spring column    Belleville spring washer    20x10.2x1.1</p>
<p><b>3</b></p> <p><math>F_{SK} = 6.5\text{kN}</math></p> <p>2 spring columns per component with 4 springs each</p>  <p>spring column    Belleville spring washer    25x12.2x1.5</p>	<p><b>4</b></p> <p><math>F_{SK} = 13.5\text{kN}</math></p> <p>2 spring columns per component with 4 springs each</p>  <p>spring column    Belleville spring washer    25x12.2x1.5</p>
<p><b>5</b></p> <p><math>F_{SK} = 13.5\text{kN}</math></p> <p>2 spring columns per component with 4 springs each</p>  <p>spring column    Belleville spring washer    34x16.3x2</p>	<p><b>6</b></p> <p><math>F_{SK} = 27\text{kN}</math></p> <p>2 spring columns per component with 4 springs each</p>  <p>spring column    Belleville spring washer    34x16.3x2</p>
<p><b>7</b></p> <p><math>F_{SK} = 37\text{kN}</math></p> <p>2 spring columns per component with 6 springs each</p>  <p>spring column    Belleville spring washer    34x16.3x2</p>	<p><b>8</b></p> <p><math>F_{SK} = 45\text{kN}</math></p> <p>2 spring columns per component with 8 springs each</p>  <p>spring column    Belleville spring washer    34x16.3x2</p>



Diagram spring column graphs 1 to 8



**Figure 6: Determining the clamping force depending on the spring packet**

## Setting the clamping force, Heatsink KE01 and KE02

### 1.) Determining the clamping force $F_S$

$F_S = 0.8F_{\max}$   
 If  $F_S > F_{SK}$ ,  
 then  $F_S = F_{SK}$

$F_S$ : requires clamping force for diode / thyristor in the heatsink  
 $F_{\max}$ : max. clamping force for diode / thyristor according to table xx  
 $F_{SK}$ : max. clamping force of the spring packet  
 $f_p$ : travel of the spring packet

### Attention!

Maximum clamping force  $F_S$  for heatsink KE01 = max. 70kN

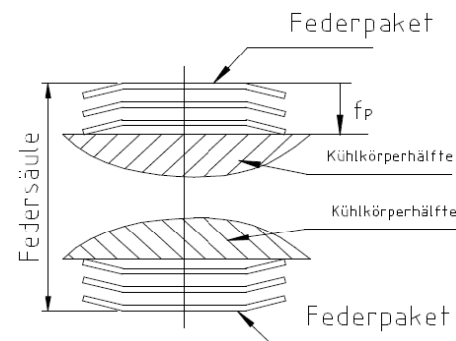
Maximum clamping force  $F_S$  for heatsink KE02 = max. 55kN

### 2.) Determining the travel of the spring packet $f_p$

2.1) Compare existing spring layers with layers 1 or 2

2.2) Read travel graphs in diagrams 1 or 2

3.) Set travel  $f_p$  by several alternating tightening



Per nut turn the following spring travel occurs:

- thread M8:  $s = 1.25\text{mm}$

Number of nut turns = two times spring travel  $f_p$  : pitch  
 $s$

Spring travel should be determined and checked resulting from the difference between column height clamped and column height unclamped (0-set point) with appropriate vernier callipers.

### Example:

Spring travel  $f_p = 0.5\text{mm}$

Thread M8 :  $s = 1.25\text{mm}$

Number of nut turns:

$2 \times 0.5\text{mm} : 1.25\text{mm} = 0.8$  turns

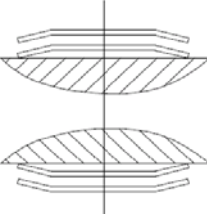
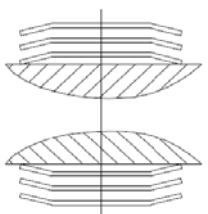
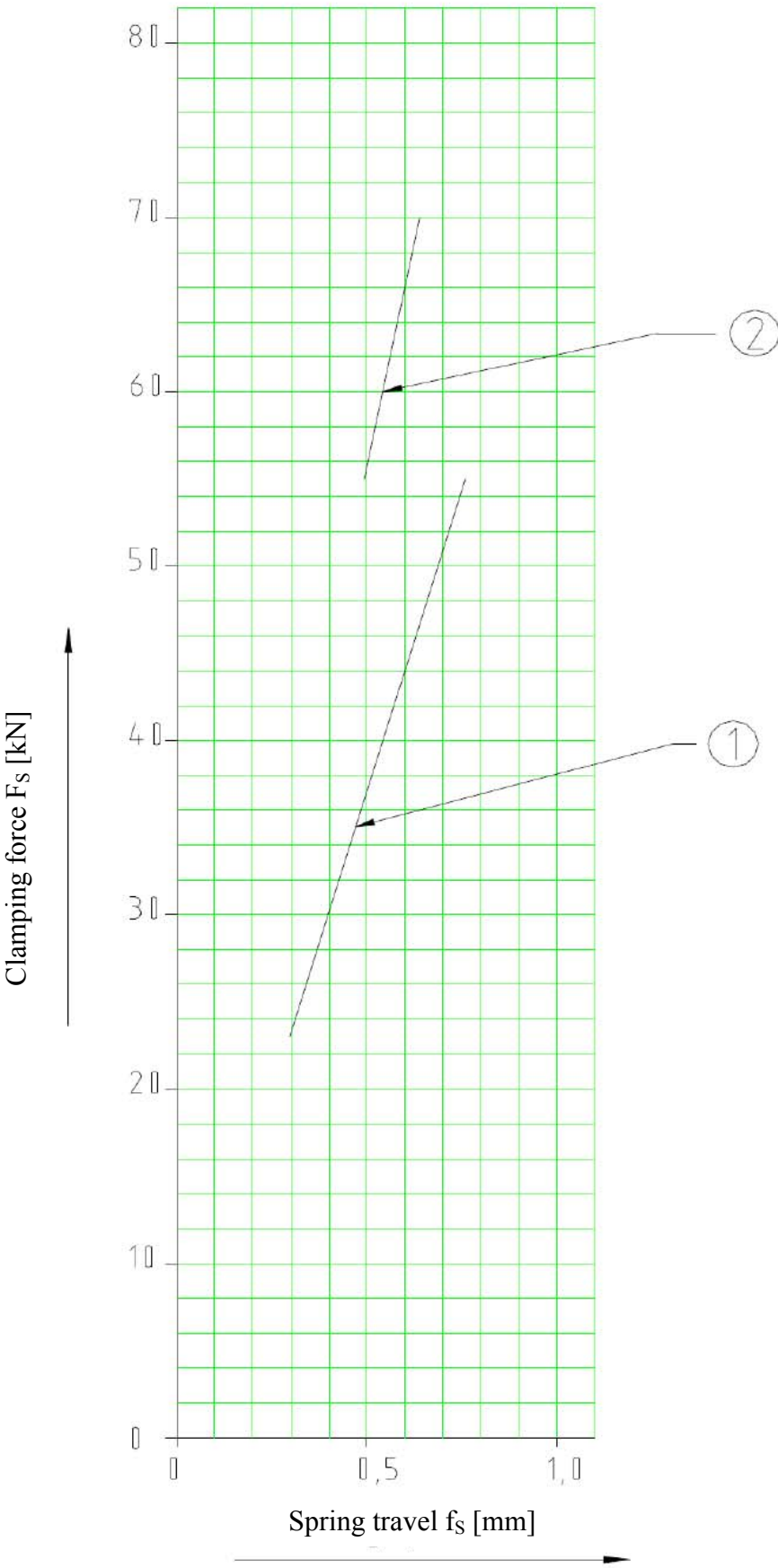
<p>1  <math>F_{SK} = 24</math> to <math>55\text{kN}</math>                      4 spring columns per component with 4 springs each</p>  <p>Belleville spring washer 34x16.3x2</p>	<p>2  <math>F_{SK} = 55</math> to <math>70\text{kN}</math>                      4 spring columns per component with 6 springs each</p>  <p>Belleville spring washer 34x16.3x2</p>
--	---

Diagram spring column graphs (KE01 and KE02)

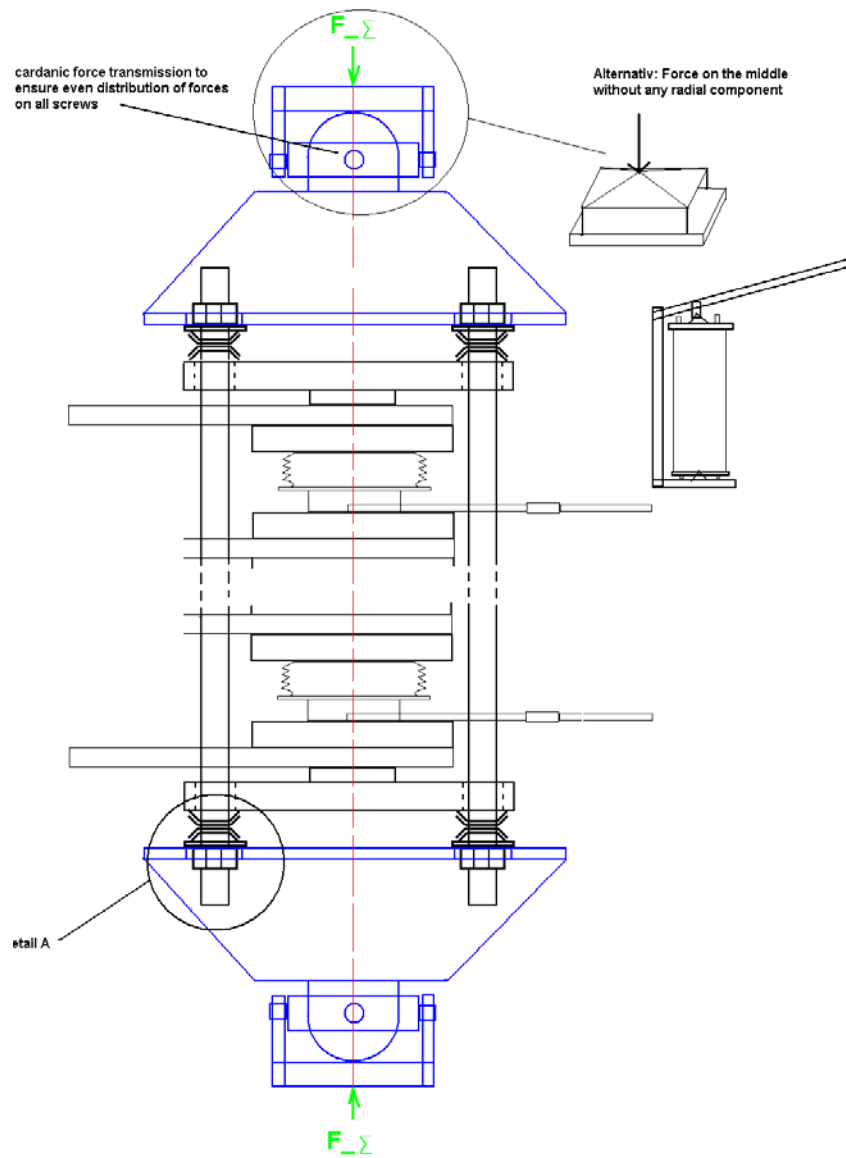


**Figure 7: Determining the clamping force depending on the spring packet (special case KE01 and KE02)**

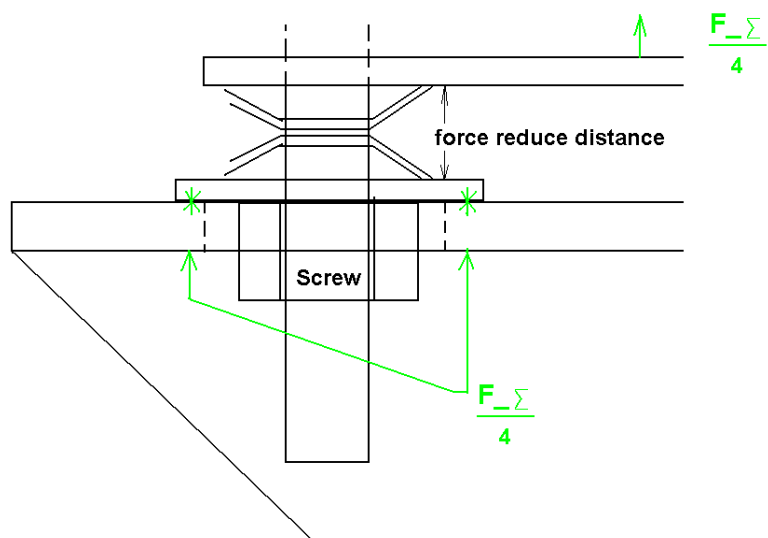
### 5.3.4 Exchange of components in water cooled stacks

This chapter is valid for all stacks similar shown in Figure 8. These are typically water cooled stacks but can also be customer specific air cooled e.g. for pulsed power.

1. Note the correct order of all spring assemblies and measure its height (this must later be readjusted to this value → see 10.)
2. Disassembly individual nuts step by step reciprocally
3. Any demounted stack - parts has to be stored cleanly. Be careful with these parts and be sure that there are no foreign parts and scratches.
4. Change any material only with the correct spare part. Assembly of all parts at the right position like before disassembling
5. The contact plates of the semiconductors are to be coated with a thin Layer of thermal compound. This work is to be done after insert of the optical fiber! (in case of optical triggered thyristors)
6. Assembly of Stack like before. Screws lightly locked (by hand)
7. Insert the Stack in a tool to press → all Parts of the Stack (refer to Figure 8 and Figure 9)
8. Be carefull in handling the fiber optic! (Bending radius min. 100mm!) (in case of optical triggered thyristors)
9. Increase the clamping force to the required level (see short form catalog)
10. Drive all screws to contact the plate by tighten reciprocally



**Figure 8: Exchange of parts in water cooled BipSTACKs**



**Figure 9: Spring assembly**

## 6 Appendix

### 6.1 Calculation table for typical circuit types

Connection topology according to DIN 41761	Vector diagram of the component side AC-voltage  Connection of converter-transformer according to VDE 0558	Effective circuit	Voltage diagram	AC-content of the DC-voltage WU, %	Frequency of the super-imposed AC-voltage  Hz	Phase voltage  $U_{2RMS}$	Phase current  $I_{2RMS}$
Single pulse connection <b>M1</b> <b>M1C</b>				121	50	2.22 * $U_{di}$	1.57 * $I_d$
Two-pulse centre-tap connection <b>M2</b> <b>M2C</b>				48	100	1.11 * $U_{di}$	0.707 * $I_d$
Two-pulse bridge connection <b>B2</b> <b>B2C</b>				48	100	1.11 * $U_{di}$	$I_d$
Three-pulse star connection <b>M3</b> <b>M3C</b>				18	150	0.855 * $U_{di}$	0.58 * $I_d$
Six-pulse star connection <b>M6</b> <b>M6C</b>				4.2	300	0.74 * $U_{di}$	0.408 * $I_d$
Double three-pulse star connection <b>M3.2</b> <b>M3.2C</b>				4.2	300	0.855 * $U_{di}$	0.289 * $I_d$
Six-pulse bridge connection <b>B6</b> <b>B6C</b>				4.2	300	0.427 * $U_{di}$	0.82 * $I_d$
Anti-parallel connection <b>W1C</b> <b>W3C</b>							

Figure 10: Calculation table for typical BipSTACK circuits (I)

	Phase current $I_{IRMS}$	Transformer nominal power $P_{TR} = \frac{P_1 + P_2}{2}$ $P_1$ $P_2$ $P_{TR}$	Branch current $I_{pRMS}$ $I_{par}$	Peak blocking voltage $U_{im}$	Current con-duction angle $\phi$	Nominal DC-voltage (VDE 0588 / IEC60146-1-1) $U_d$  At mains RMS voltage 125V, 230V, 400V, 500V, 690V
M1	$1.21 * \frac{U_2}{U_1} * I_d$	$3.49 * P_{di}$ $2.69 * P_{di}$ $3.1 * P_{di}$	$1.57 * I_d$ $I_d$	$U_{2RMS} * \sqrt{2}$	180°el	55V, 100V, 175V, 200V, ---
M2	$\frac{U_2}{U_1} * I_d$	$1.57 * P_{di}$ $1.11 * P_{di}$ $1.34 * P_{di}$	$0.707 * I_d$ $0.5 * I_d$	$2 * U_{2RMS} * \sqrt{2}$	180°el	55V, 100V, 175V, 200V, ---
B2	$\frac{U_2}{U_1} * I_d$	$1.11 * P_{di}$ $1.11 * P_{di}$ $1.11 * P_{di}$	$0.707 * I_d$ $0.5 * I_d$	$U_{2eff} * \sqrt{2}$	180°el	110V, 220V, 350V, 445V, ---
M3	$0.47 * \frac{U_2}{U_1} * I_d$	$1.48 * P_{di}$ $1.21 * P_{di}$ $1.35 * P_{di}$	$0.58 * I_d$ $0.33 * I_d$	$1.73 * U_{2RMS} * \sqrt{2}$	120°el	80V, 150V, 265V, 335V, ---
M6	$0.577 * \frac{U_2}{U_1} * I_d$	$1.81 * P_{di}$ $1.28 * P_{di}$ $1.55 * P_{di}$	$0.408 * I_d$ $0.17 * I_d$	$2 * U_{2RMS} * \sqrt{2}$	60°el	80V, 155V, 265V, 335V, ---
M3.2	$0.408 * \frac{U_2}{U_1} * I_d$	$1.48 * P_{di}$ $1.05 * P_{di}$ $1.26 * P_{di}$	$0.289 * I_d$ $0.17 * I_d$	$2 * U_{2RMS} * \sqrt{2}$	120°el	70V, 130V, 230V, 280V, ---
B6	$0.82 * \frac{U_2}{U_1} * I_d$	$1.05 * P_{di}$ $1.05 * P_{di}$ $1.05 * P_{di}$	$0.58 * I_d$ $0.33 * I_d$	$1.73 * U_{2RMS} * \sqrt{2}$	120°el	165V, 310V, 540V, 670V, 920V
W1C W3C			$I_{IRMS} * 0.707$ $I_{IRMS} * 0.45$	$U_{IRMS} * \sqrt{2}$	180°el	

Except for circuit M1 all values apply for totally filtered DC. Ratio =  $U_2 / U_1$


1) without choke

2)  $P_{di} = I_d \times U_{di}$

**Figure 11: Calculation table for typical BipSTACK circuits (II)**

## 6.2 Request for a technical offer

Please print out the following two pages and send them to us:

<b>Checklist for Bipolar Assemblies</b>						
<b>Project Name</b>						
<input type="text"/>						
please refer to this name in every correspondence regarding the stack described below						
<b>Device</b>						
<input type="checkbox"/> Disc	<input type="checkbox"/> Module	if possible				
<b>rectifier circuit with mid-point tapping</b>						
Uncontrolled	<input type="checkbox"/> M1U	<input type="checkbox"/> M2U	<input type="checkbox"/> M3U	<input type="checkbox"/> M3.2U	<input type="checkbox"/> M6U	
Full controlled	<input type="checkbox"/> M1C	<input type="checkbox"/> M2C	<input type="checkbox"/> M3C	<input type="checkbox"/> M3.2C	<input type="checkbox"/> M6C	
		<input type="checkbox"/> with common cathode		<input type="checkbox"/> with common anode		
<b>bridge rectifier circuit</b>						
uncontrolled	<input type="checkbox"/> B2U	<input type="checkbox"/> B6U	<input type="checkbox"/> B6.2U			
half controlled	<input type="checkbox"/> B2H	<input type="checkbox"/> B6H	<input type="checkbox"/> B6.2H	<input type="checkbox"/> thyr. with common anode		
full controlled	<input type="checkbox"/> B2C	<input type="checkbox"/> B6C	<input type="checkbox"/> B6.2C			
prepared for operation						
		<input type="checkbox"/> parallel	<input type="checkbox"/> serial	<input type="checkbox"/> antiparallel		
<b>AC switch</b>						
half controlled	<input type="checkbox"/> W1H	<input type="checkbox"/> W2H	<input type="checkbox"/> W3H			
full controlled	<input type="checkbox"/> W1C	<input type="checkbox"/> W2C	<input type="checkbox"/> W3C			
<b>supply voltage</b>			<b>frequency</b>			
<input type="text"/> V			<input type="text"/> Hz			
<b>output current</b>						
<input type="text"/> A <sub>DC</sub> (rectifier) or A <sub>RMS</sub> (AC switch)						
<b>load mode</b>						
<input type="checkbox"/> permanent						
<input type="checkbox"/> overload	overcurrent	<input type="text"/>	A	time	<input type="text"/>	s
		preload current	<input type="text"/>			A
<input type="checkbox"/> non periodical overload according to separate diagram						
<b>temperature of cooling media (e.g. ambient temperature)</b>						
T <sub>min</sub>		<input type="text"/>	°C	T <sub>max</sub>		<input type="text"/>
						°C
<b>cooling mode</b>						
<input type="checkbox"/> natural air	<input type="checkbox"/> forced air	<input type="checkbox"/> water	<input type="checkbox"/> oil	<input type="checkbox"/> own	R <sub>tha</sub>	<input type="text"/> K/W
		<input type="checkbox"/> without fan	<input type="checkbox"/> fan 230VAC	<input type="checkbox"/> fan 115VAC		



# Checklist for Bipolar Assemblies



## temperature switch

<input type="checkbox"/> without	<input type="checkbox"/> O (NC normally closed)	<input type="checkbox"/> S (NO normally open)
<input type="checkbox"/> special temperature		T <input type="text"/> °C

## overvoltage protection

<input type="checkbox"/> no overvoltage protection	
<input type="checkbox"/> RC1: TSE - snubber circuit	<input type="checkbox"/> RC2: snubber input bridge
<input type="checkbox"/> RC3: RC1 + RC2	
<input type="checkbox"/> ARC: AC side RC-snubber	<input type="checkbox"/> DRC: DC side protection

## fuses

<input type="checkbox"/> without	<input type="checkbox"/> cell fuses	<input type="checkbox"/> arm fuses
----------------------------------	-------------------------------------	------------------------------------

## quantity

<input type="text"/> pieces
-----------------------------

## attachments

<input type="text"/> number of enclosed sheets / data files with additional information
---

## space for remarks


## customer

company:	<input type="text"/>	street:	<input type="text"/>
name:	<input type="text"/>	post box:	<input type="text"/>
phone:	<input type="text"/>	zip code/place:	<input type="text"/>
fax:	<input type="text"/>	country:	<input type="text"/>
e-mail:	<input type="text"/>	Date:	<input type="text"/>

please send back this checklist to your responsible sales or contact person – otherwise send back to e-mail: [info@infineon.com](mailto:info@infineon.com) or fax: 0049 (0)2902 764-1102

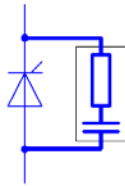
# Checklist for Bipolar Assemblies



## Overvoltage Protection Circuits

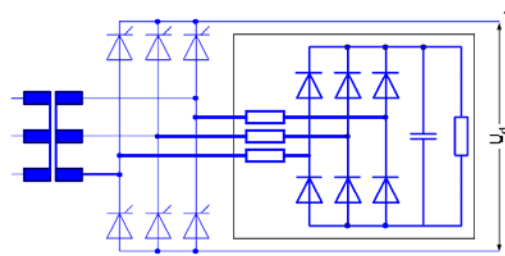
### RC1 TSE snubber circuit

To avoid over voltages due to the reverse recovery charge effect every diode/thyristor is equipped with a parallel RC snubber which absorbs the charge/energy and which is a damping for possible oscillations.



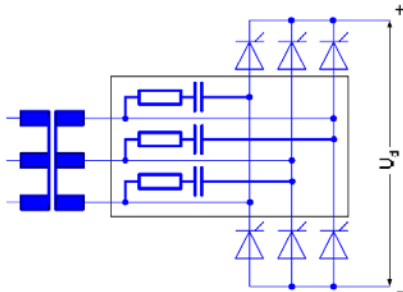
### RC2 input snubber bridge

To absorb surge voltages of higher magnitude inrushing from line an auxiliary rectifier is mounted in parallel to the rectifier. This auxiliary rectifier has a storage capacitor connected to the output which will absorb inrushing surges. Besides this there is also a restricted functionality as TSE.



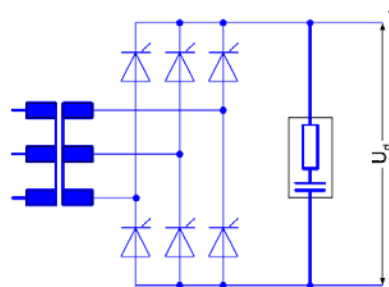
### ARC AC side RC snubber

To absorb surge voltages of lower magnitude inrushing from line RC snubbers are placed phase to phase on the AC side of the rectifier (recommended for DC currents up to 200A)



### DRC DC side RC snubber

To avoid overvoltage at the DC side of a rectifier a RC snubber is mounted. This is helpful if there is no capacitor as DC link close to the rectifier output



# Checklist for Bipolar Assemblies



## rectifier circuits with mid-point tapping

M1U 	M2U 	M3 	M3.2U 	M6U 
M1C 	M2C 	M3C 	M3.2C 	M6C 

\*) All star rectifiers available also with common anode.

## bridge rectifier circuits

uncontrolled	B2U 	B6U 	B6.2U*** 
half controlled**	B2H 	B6H 	B6.2H*** 
full controlled	B2C 	B6C 	B6.2C*** 

\*\* ) All half controlled bridge rectifiers available also with thyristors with common anode.

\*\*\* ) Can be prepared for series, parallel or anti-parallel operation.

## AC switches

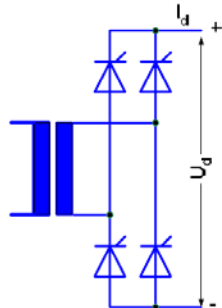
W1H 	W2H 	W3H 
W1C 	W2C 	W3C 

# Checklist for Bipolar Assemblies

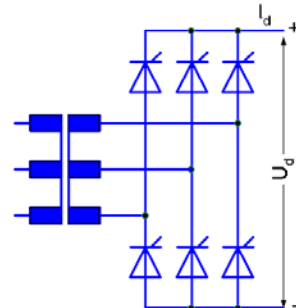


Examples of most common standard circuits:

B2

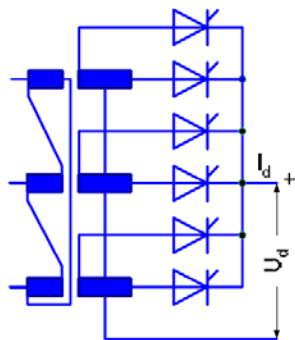


B6



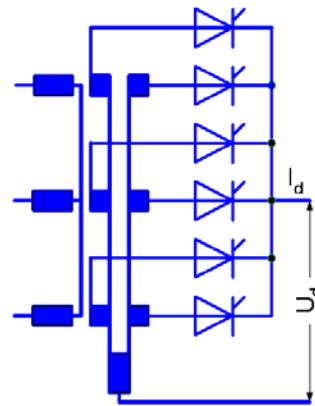
M6

especially for high current at low voltage



M3.2

especially for high current at low voltage



### 6.3 Reference table for water cooling

Stacks		Water cooling Cooling medium H <sub>2</sub> O					
Technical notes		(totally desalinated) VE-water = (deionised) DI-water	distilled = softened water, aqua destillata	monitored cooling water/ boiler feed water set values	monitored cooling water/ boiler feed water typical values	tap water process water well water *)	Value pairs with directly proportionate parameters
<b>Water type</b>							
<b>Check parameters</b>							
Water hardness		0° dH	0 - 1 ° dH	5 - 6 ° dH	6 - 7 ° dH	(10) 12 - 18 ° dH	° dH 0 5
pH-value		5.5	7 - 8	7 - 8	8	7 - 8 (9)	
el. conductivity K		0.5 µS/cm	typ. 50 µS/cm	180 - 220 µS/cm	200 µS/cm	400 - 500 µS/cm	µS/cm 0.5 180
spec. el. resistance p		2 MΩ cm	20 kΩ cm	5.5 - 4.5 kΩ cm	5 kΩ cm	2.5 - 2 kΩ cm	
Chlorine ions Cl		0 mg/l	6 - 8 mg/l	4 - 5 mg/l	5 mg/l	8 - 10 mg/l	
<b>Rating</b>		negative	provisional	very good	good	negative	
<b>Produce = Mixing</b>		○	○	○	○	○	
<b>pH-values</b>							
0 - 2	very acidic						
4 - 5	slightly acidic						
7	neutral						
9 - 10	slightly alkaline						
11 - 14	strongly alkaline						
*) Rain water is usually a chemical today							
<b>Monitoring/Checks</b>							
(1) taking samples							
° dH; pH; K; Cl							
freshly prepared ≤ 3 months							
then 1 x per week							
<b>Water hardness</b>							
- origin: Ca O - sediment: Ca CO <sub>3</sub> Ca SO <sub>4</sub>							
(2) by visual check							
Colouration by foreign ionisation							
Mg O (salt) Mg CO <sub>3</sub>							
turbid							
brown Fe							
green Ni							
blue Cu							
clear = correct							
<b>Minimum flow velocity:</b>							
standing water							
causes							
germination, siltling							
<b>Water quality</b>							
Sheet 3							

## 6.4 Further associated documentation

The documents listed below are effective in parallel to this BipSTACK product family documentation. All information can be found either on the Internet [www.infineon.com](http://www.infineon.com) or please contact us directly. We are pleased to give advice regarding all information recorded in the current documents. You find our contact address in the appendix of this document.

- **BipSTACK datasheet**
- **Calculation sheet for continuous operation (regarding individual stacks)**
- **Calculation sheet for short term operation (regarding individual stacks)**
- **Application Notes**

All Infineon ANs published until the installation date of the BipSTACK are valid regarding:

- BipSTACK, especially:
  - AN2006-03
- Other relevant components of the BipSTACK

## 6.5 Indices

### 6.5.1 Index of terms

120° square wave current 19  
400Hz 19  
50Hz and 60Hz applications 19  
AC controller 11  
Air filters 14  
Application Notes 38  
Arc voltage 17  
Area of application 8  
Assembly 5  
B-Circuit 11  
Bipolar 5  
BipSTACK 4, 5  
Block 6  
Blocking voltage 16  
Branch fuse 17  
Bridges for rectification 11  
Calculation sheet for continuous operation 21, 38  
Calculation sheet for short term operation 21, 38  
Calculation table 31  
Calculatory basics 19  
Cell fuse 17  
center-tap circuit 11  
Checklist for Bipolar Assemblies 21  
Circuit topology 8  
Closed cooler plate 12  
commissioning 22  
Component 6  
Conditions of use 41  
Contact 42  
Contactor controlled charge resistor 20  
Convection cooling 13, 19  
Cooler for mains applications 12  
Cooling blocks 6  
Cooling capsule 14  
Cooling type 8  
Corrosion 15  
Current derating 10, 20  
Datasheet 8, 38  
Derating 22  
Design 19  
Determining the clamping force 25, 27  
Dimensional drawing 21  
DIN41762 7  
DIN50930 15  
DIN57558 16  
Dust 23  
EN50178 23  
Exchange of components 23  
Extent of the offer 21  
Fan 10  
Flow monitor 15  
Flow velocity 15  
Forced Air cooling 12, 19  
Form factor 19  
Frequencies 19  
Further associated documentation 38  
Fuse 8, 10, 17, 23  
Fuse monitoring 17  
Fuses with inverter operation 18  
Galvanic separation of the thyristor gate 18  
Galvanizing and plating plants 6  
Heat exchanger 15  
Heatsink 8  
Hose connection 15  
Hose diameter 15  
Hose length 15  
Ideal conditions 19  
IEC61800 23  
Inlet temperature 10  
Input protection 16  
Installation 22  
Insulation disc 16  
Iso-disc 14  
K0,024W 14  
K0,048F 13  
K0,05F 12, 13  
K0,08.7F 12  
K0,08F 12  
K0,11F 12  
K0,12F 13  
K0,17F 13  
K0,18S 14  
K0,22F 13  
K0,2S 13  
K0,36S 14  
K0,92S 14  
K53 14  
K63 14  
K84 14  
KA20 14  
KC20 14  
KD20 14  
KE01 13  
KE02 13  
KM10 12  
KM11 12  
KM14 12  
KM17 12  
KM18 12  
KW30 12  
KW50 12  
KW60 12  
KW61 12  
KW65 12  
KW70 12  
Kx cooler family 13  
Load type 8  
Low load operation 17  
Maintenance 23  
Material degradation 15  
M-Circuit 11  
Mechanical construction 11  
Micro-switch 18  
ModSTACK™ 8

Noise pollution	15
Normally closed	10, 17
Normally open	10, 17
Open isolation	14
Open water cooling	12
Overload	10
Overload capability	15
Over-voltage	20
Over-voltages	16
Parallel connection	20
Partial circuit surge suppression (TSE)	16
Peak reverse voltage	17
Power dissipation losses	19
Power loss	10
Power rating	6
PrimeSTACK	8
Protection circuitry	16, 20
Pulsed-Power	6, 11
$Q_R$	16
Rated operating point	7
Rectifier	6
Regulations	8
Request an offer	21, 32
Reverse recovery charge	16
$R_{thja}$	10
SAP number	8
SEB	16
Semiconductor module	11
Setting the clamping force	24, 26
Short circuit impedance voltage $u_K$ of the transformer	16, 18
Short term operation	13
Softstarter	6, 11
Stack	5, 6
Standard BipSTACK-series	20
Standards	8
Storage	22
Storage charge	19
Temperature monitoring	15
Temperature switch	10, 17
Trained and instructed personnel	6
Transport	22
Trigger pulse	8
Trigger transformers	18
TSE	16, 20
Type AC-current	10
Type connection voltage	9
Type DC-current	9
Type DC-voltage	9
Type designation	7, 8
Type nominal power of the rectifier transformer	16
$V_{RRM}$	16
Water circuit	12
Water cooling	19, 37
Water flow control	15
Water quality	15
Water temperature lift	15
Water types	15
W-Circuit	11
Wind energy turbine	6

## 6.5.2 List of figures

Figure 1: Example of a BipSTACK: 2B6C with input protection circuitry and busbars: .....	5
Figure 2: Difference: Stack – Block - Component .....	6
Figure 3: Conceptual illustration of the Kx cooler family. Up to 3 discs are mounted onto one heatsink half. The number of disc cells determines the number of heatsink counterparts and so defines the $R_{th}$ , which in turn provides the basis for the name. ....	13
Figure 4: Partial circuit surge suppression (TSE) .....	16
Figure 5: Input protection (SEB).....	17
Figure 6: Determining the clamping force depending on the spring packet.....	25
Figure 7: Determining the clamping force depending on the spring packet (special case KE01 and KE02).....	27
Figure 8: Exchange of parts in water cooled BipSTACKs.....	29
Figure 9: Spring assembly.....	29
Figure 10: Calculation table for typical BipSTACK circuits (I) .....	30
Figure 11: Calculation table for typical BipSTACK circuits (II).....	31



## 6.6 Conditions of use

The data contained in this product information is exclusively intended for technically trained staff. You or your technical departments will have to evaluate the suitability of the described products for the intended application and the completeness of the product data provided with respect to such application.

This product documentation describes those features which are ensured by us under the delivery contract. Such a guarantee references back exclusively to the regulations contained in the individual delivery contract. No guarantee of any kind will be given for the product or its properties.

Should you require product information in addition to the contents of this product information which concerns the specific application and use of this product, please contact the sales office which is responsible for your area. For those interested we may provide application notes.

Due to technical requirements our products may contain substances which can endanger your health. For information regarding the substances contained in the specific product please also contact the sales office responsible for your area.

Should you intend to use the products in aviation applications or in uses where health or life is endangered or in life support, please contact Infineon. Please note that for any such application we strongly recommend

- to jointly perform a risk and quality assessment,
- to draw up a quality assurance agreement,
- to establish joint measures for ongoing product monitoring and that delivery of product may depend on such measures.

If and to the extent necessary, please forward equivalent notices to your customers.

Changes to this product documentation are reserved.

## 6.7 Contact

**Address** Infineon Technologies AG  
59581 Warstein / Germany  
Max-Planck-Strasse 5

**Internet** [www.infineon.com](http://www.infineon.com)  
→ „Power Semiconductors“  
→ “High Power Semiconductors”

**Personal contact** Tel: ++49 – (0)2902 – 764 0  
Fax: ++49 - (0)2902 – 764 1102

**Electronic contact** [info@infineon.com](mailto:info@infineon.com)