

## General-purpose grade capacitors

### Applications

- Switch-mode power supplies in industrial and entertainment electronics

### Features

- Extremely miniaturized
- High ripple current capability
- Many different case sizes available for each capacitance value

### Construction

- Charge-discharge proof, polar
- Aluminum case, fully insulated
- Snap-in solder pins to hold component in place on PC-board
- Minus pole marking on case surface
- Minus pole not insulated from case
- Overload protection (safety vent)

### Terminals

- Standard version with 2 terminals  
2 lengths available: 6,3 and 4,5 mm
- 3 terminals: length 4,5 mm  
(terminal arrangement ensures correct insertion)

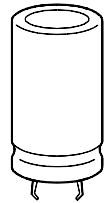

**Specifications and characteristics in brief**

Rated voltage $U_R$	200 ... 450 VDC	
Surge voltage $U_S$	$1,15 \cdot U_R$ (for $U_R \leq 250$ VDC) $1,10 \cdot U_R$ (for $U_R \geq 400$ VDC)	
Rated capacitance $C_R$	82 ... 2 200 $\mu\text{F}$	
Capacitance tolerance	$\pm 20 \% \triangleq M$	
Dissipation factor $\tan \delta$ (20 °C, 120 Hz)	$U_R \leq 250$ V: $\tan \delta \leq 0,15$ $U_R \geq 400$ V: $\tan \delta \leq 0,20$	
Leakage current $I_L$ (5 min, 20 °C)	$I_L \leq 0,3 \mu\text{A} \cdot \left( \frac{C_R}{\mu\text{F}} \cdot \frac{U_R}{\text{V}} \right)^{0,7} + 4 \mu\text{A}$	
Self-inductance $ESL$	Approx. 20 nH	
Useful life 85 °C; $U_R$ ; $I_{\sim\text{max}}$ 40 °C; $U_R$ ; $1,15 \cdot I_{\sim\text{R}}$	$> 2\,000$ h $> 100\,000$ h	<b>Requirements:</b> $\Delta C/C \leq \pm 30\%$ of initial value $\tan \delta \leq 3$ times initial specified limit $I_L \leq$ initial specified limit Failure percentage: $\leq 1\%$ Failure rate: $\leq 100$ fit ( $\leq 100 \cdot 10^{-9}/\text{h}$ ) (for definition "fit", refer to chapter "Quality", page 62)
Load life test 85 °C; $U_R$ ; $I_{\sim\text{R}}$	2 000 h	<b>Post test requirements:</b> $\Delta C/C \leq \pm 20\%$ of initial value $\tan \delta \leq 2$ times initial specified limit $I_L \leq$ initial specified limit
Voltage endurance test 85 °C; $U_R$	2 000 h	<b>Post test requirements:</b> $\Delta C/C \leq \pm 10\%$ of initial value $\tan \delta \leq 1,3$ times initial specified limit $I_L \leq$ initial specified limit
Vibration resistance	To IEC 60068-2-6, test Fc: displacement amplitude 0,35 mm, frequency range 10 ... 55 Hz, acceleration max. 5 g, duration $3 \times 2$ h	
IEC climatic category	To IEC 60068-1: $U_R \leq 250$ VDC: 40/085/56 (– 40 °C/+ 85 °C/56 days damp heat test) $U_R \geq 400$ VDC: 25/085/56 (– 25 °C/+ 85 °C/56 days damp heat test)	
Detail specification	Similar to CECC 30301-806	
Sectional specification	IEC 60384-4	

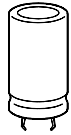
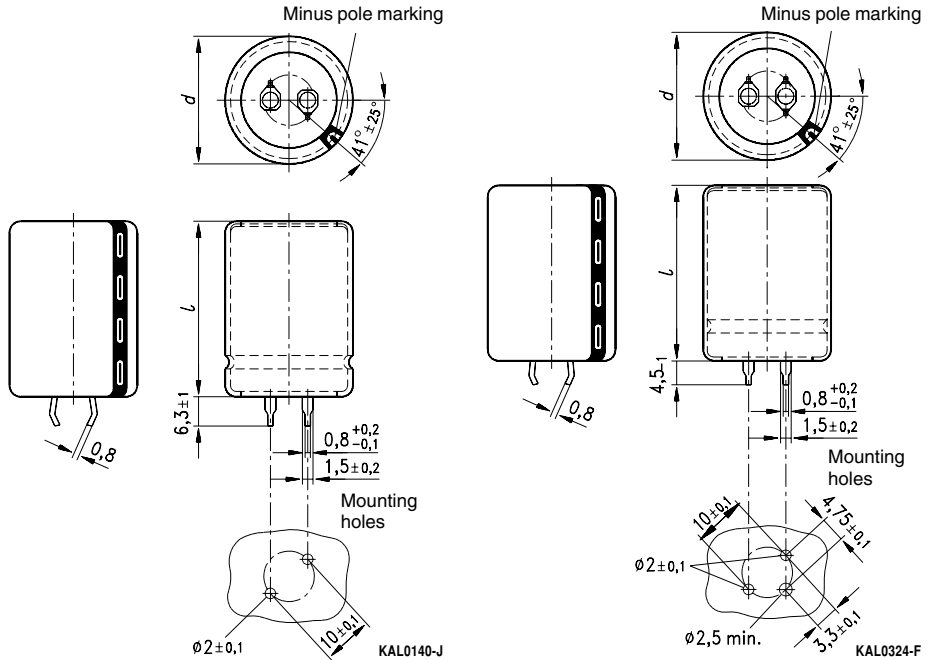
**Dimensional drawings**

Snap-in terminals, standard (length  $6,3 \pm 1$  mm). Also available in a shorter version with a length of  $4,5 - 1$  mm. For packing mode and ordering example see next page.

Snap-in capacitors are also available with 3 terminals (length  $4,5 - 1$  mm). For packing mode and ordering example see next page.

Dimensions (mm)		Approx. weight (g)	Packing units (pieces)
$d + 1$	$l \pm 2$		
22	25	9	160
22	30	12	160
22	35	15	160
22	40	18	160
22	45	20	160
22	50	24	160
25	25	13	130
25	30	17	130
25	35	19	130
25	40	22	130
25	45	25	130
25	50	29	130

Dimensions (mm)		Approx. weight (g)	Packing units (pieces)
$d + 1$	$l \pm 2$		
30	25	17	80
30	30	23	80
30	35	29	80
30	40	36	80
30	45	41	80
30	50	46	80
35	25	22	60
35	30	29	60
35	35	36	60
35	40	41	60
35	45	56	60
35	50	70	60



B43304

Miniaturized – 85 °C

### Packing of snap-in capacitors



For ecological reasons the packing is pure cardboard. Components can be withdrawn (in full or in part) in the correct position for insertion.

### Ordering codes

Snap-in terminals Version	Identification in 3rd block of ordering code
Standard terminals (6,3 ± 1) mm	M000
Short terminals (4,5 –1) mm	M007
3 terminals (4,5 –1) mm	M002

Ordering example:

B43304A9107M007 } snap-in capacitor with short terminals  
B43304A9107M002 } snap-in capacitor with 3 terminals

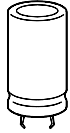

**Overview of available types**

$U_R$ (VDC)	200	250	400	450
$C_R$ ( $\mu$ F)	Case dimensions $d \times l$ (mm)			
82				22 × 25
100			22 × 25	22 × 30 25 × 25
120			22 × 30 25 × 25	22 × 35 25 × 30
150			22 × 35 25 × 30	22 × 40 25 × 30 30 × 25
180			22 × 40 25 × 30 30 × 25	22 × 45 25 × 35 30 × 30
220		22 × 25	22 × 45 25 × 35 30 × 30	22 × 50 25 × 40 30 × 30 35 × 25
270		22 × 30	22 × 50 25 × 40 30 × 30 35 × 25	25 × 45 30 × 35 35 × 30
330	22 × 25	22 × 30 25 × 25	25 × 45 30 × 35 35 × 30	30 × 40 35 × 35
390	22 × 30 25 × 25	22 × 35 25 × 30	25 × 50 30 × 40 35 × 30	30 × 45 35 × 35
470	22 × 35 25 × 30	22 × 40 25 × 35 30 × 25	30 × 45 35 × 35	30 × 50 35 × 40
560	22 × 35 25 × 30	22 × 45 25 × 35 30 × 30	30 × 50 35 × 40	35 × 45
680	22 × 40 25 × 35 30 × 25	22 × 50 25 × 40 30 × 30 35 × 25	35 × 45	
820	22 × 45 25 × 40 30 × 30 35 × 25	25 × 45 30 × 35 35 × 30		

**Overview of available types**

$U_R$ (VDC)	200	250	400	450
$C_R$ ( $\mu$ F)	Case dimensions $d \times l$ (mm)			
1 000	25 × 45 30 × 35 35 × 30	30 × 40 35 × 35		
1 200	25 × 50 30 × 40 35 × 30	30 × 45 35 × 35		
1 500	30 × 45 35 × 35	35 × 45		
1 800	30 × 50 35 × 40	35 × 50		
2 200	35 × 45			

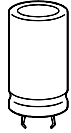
The capacitance and voltage ratings listed above are available in different cases upon request.  
Other voltage and capacitance ratings are also available upon request.

**Technical data and ordering codes**

$U_R$	$C_R$	Case dimensions	$ESR_{typ}$	$Z_{max}$	$I_{-max}$	$I_{-R}^{1)}$	Ordering code <sup>2)</sup>
VDC	100 Hz 20 °C $\mu F$	$d \times l$ mm	100 Hz 20 °C m $\Omega$	10 kHz 20 °C m $\Omega$	100 Hz 40 °C A	100 Hz 85 °C A	
200	330	22 × 25	470	560	2,7	1,2	B43304A2337M000
	390	22 × 30	400	480	3,1	1,4	B43304A2397M000
	390	25 × 25	400	480	3,2	1,4	B43304B2397M000
	470	22 × 35	330	400	3,6	1,6	B43304A2477M000
	470	25 × 30	330	400	3,7	1,7	B43304B2477M000
	560	22 × 35	280	330	4,0	1,8	B43304A2567M000
	560	25 × 30	280	330	4,1	1,8	B43304B2567M000
	680	22 × 40	230	280	4,6	2,1	B43304A2687M000
	680	25 × 35	230	280	4,7	2,1	B43304B2687M000
	680	30 × 25	230	280	4,6	2,1	B43304C2687M000
	820	22 × 45	190	230	5,3	2,4	B43304A2827M000
	820	25 × 40	190	230	5,5	2,5	B43304B2827M000
	820	30 × 30	190	230	5,4	2,4	B43304C2827M000
	820	35 × 25	190	230	5,6	2,6	B43304D2827M000
	1 000	25 × 45	160	190	6,3	2,9	B43304A2108M000
	1 000	30 × 35	160	190	6,2	2,8	B43304B2108M000
	1 000	35 × 30	160	190	6,6	3,0	B43304C2108M000
	1 200	25 × 50	130	160	7,2	3,3	B43304A2128M000
	1 200	30 × 40	130	160	7,2	3,3	B43304B2128M000
	1 200	35 × 30	130	160	7,2	3,3	B43304C2128M000
	1 500	30 × 45	110	130	8,4	3,8	B43304A2158M000
	1 500	35 × 35	110	130	8,5	3,9	B43304B2158M000
	1 800	30 × 50	90	110	8,7	4,0	B43304A2188M000
	1 800	35 × 40	90	110	8,9	4,0	B43304B2188M000
	2 200	35 × 45	70	90	10,2	4,6	B43304A2228M000

1) 120 Hz conversion factor of ripple current:  $I_{-}(120\text{ Hz}) = 1,03 \cdot I_{-}(100\text{ Hz})$

2) Ordering code for standard terminals (6,3 mm).

To determine the ordering code for short terminals (4,5 mm) and 3 terminals (4,5 mm) see page 226.

**Technical data and ordering codes**

$U_R$	$C_R$	Case dimensions	$ESR_{typ}$	$Z_{max}$	$I_{~max}$	$I_{~R}^{1)}$	Ordering code <sup>2)</sup>
VDC	100 Hz 20 °C $\mu F$	$d \times l$ mm	100 Hz 20 °C m $\Omega$	10 kHz 20 °C m $\Omega$	100 Hz 40 °C A	100 Hz 85 °C A	
250	220	22 × 25	700	840	2,2	1,0	B43304E2227M000
	270	22 × 30	570	690	2,6	1,2	B43304E2277M000
	330	22 × 30	470	560	2,9	1,3	B43304E2337M000
	330	25 × 25	470	560	2,9	1,3	B43304G2337M000
	390	22 × 35	400	480	3,3	1,5	B43304E2397M000
	390	25 × 30	400	480	3,4	1,5	B43304G2397M000
	470	22 × 40	330	400	3,8	1,7	B43304E2477M000
	470	25 × 35	330	400	3,9	1,8	B43304G2477M000
	470	30 × 25	330	400	3,8	1,7	B43304H2477M000
	560	22 × 45	280	330	4,4	2,0	B43304E2567M000
	560	25 × 35	280	330	4,3	1,9	B43304G2567M000
	560	30 × 30	280	330	4,4	2,0	B43304H2567M000
	680	22 × 50	230	280	5,0	2,3	B43304E2687M000
	680	25 × 40	230	280	5,0	2,3	B43304G2687M000
	680	30 × 30	230	280	4,9	2,2	B43304H2687M000
	680	35 × 25	230	280	5,1	2,3	B43304J2687M000
	820	25 × 45	190	230	5,7	2,6	B43304E2827M000
	820	30 × 35	190	230	5,7	2,6	B43304G2827M000
	820	35 × 30	190	230	6,0	2,7	B43304H2827M000
	1 000	30 × 40	160	190	6,6	3,0	B43304E2108M000
	1 000	35 × 35	160	190	6,9	3,1	B43304G2108M000
	1 200	30 × 45	130	160	7,5	3,4	B43304E2128M000
	1 200	35 × 35	130	160	7,6	3,4	B43304G2128M000
	1 500	35 × 45	110	130	8,4	3,8	B43304E2158M000
	1 800	35 × 50	90	110	9,6	4,4	B43304E2188M000

1) 120 Hz conversion factor of ripple current:  $I_{~}(120 \text{ Hz}) = 1,03 \cdot I_{~}(100 \text{ Hz})$

2) Ordering code for standard terminals (6,3 mm).

To determine the ordering code for short terminals (4,5 mm) and 3 terminals (4,5 mm) see page 226.

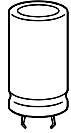

**Technical data and ordering codes**

$U_R$	$C_R$	Case dimensions	$ESR_{typ}$	$Z_{max}$	$I_{-max}$	$I_{-R}^{1)}$	Ordering code <sup>2)</sup>
VDC	100 Hz 20 °C $\mu F$	$d \times l$ mm	100 Hz 20 °C m $\Omega$	10 kHz 20 °C m $\Omega$	100 Hz 40 °C A	100 Hz 85 °C A	
400	100	22 × 25	1 630	1 960	1,5	0,67	B43304A9107M000
	120	22 × 30	1 360	1 630	1,7	0,79	B43304A9127M000
	120	25 × 25	1 360	1 630	1,8	0,80	B43304B9127M000
	150	22 × 35	1 090	1 310	2,0	0,93	B43304A9157M000
	150	25 × 30	1 090	1 310	2,1	0,95	B43304B9157M000
	180	22 × 40	910	1 090	2,4	1,1	B43304A9187M000
	180	25 × 30	910	1 090	2,3	1,0	B43304B9187M000
	180	30 × 25	910	1 090	2,4	1,1	B43304C9187M000
	220	22 × 45	740	890	2,7	1,2	B43304A9227M000
	220	25 × 35	740	890	2,7	1,2	B43304B9227M000
	220	30 × 30	740	890	2,8	1,3	B43304C9227M000
	270	22 × 50	610	730	3,2	1,4	B43304A9277M000
	270	25 × 40	610	730	3,1	1,4	B43304B9277M000
	270	30 × 30	610	730	3,1	1,4	B43304C9277M000
	270	35 × 25	610	730	3,2	1,5	B43304D9277M000
	330	25 × 45	500	600	3,6	1,6	B43304A9337M000
	330	30 × 35	500	600	3,6	1,6	B43304B9337M000
	330	35 × 30	500	600	3,8	1,7	B43304C9337M000
	390	25 × 50	420	510	4,1	1,9	B43304A9397M000
	390	30 × 40	420	510	4,1	1,9	B43304B9397M000
	390	35 × 30	420	510	4,1	1,9	B43304C9397M000
	470	30 × 45	350	420	4,7	2,1	B43304A9477M000
	470	35 × 35	350	420	4,7	2,2	B43304B9477M000
	560	30 × 50	300	350	5,3	2,4	B43304A9567M000
	560	35 × 40	300	350	5,4	2,5	B43304B9567M000
	680	35 × 45	240	290	6,2	2,8	B43304A9687M000

1) 120 Hz conversion factor of ripple current:  $I_{-}(120\text{ Hz}) = 1,03 \cdot I_{-}(100\text{ Hz})$

2) Ordering code for standard terminals (6,3 mm).

To determine the ordering code for short terminals (4,5 mm) and 3 terminals (4,5 mm) see page 226.



**Technical data and ordering codes**

$U_R$	$C_R$	Case dimensions	$ESR_{typ}$	$Z_{max}$	$I_{~max}$	$I_{~R}^{1)}$	Ordering code <sup>2)</sup>
VDC	100 Hz 20 °C $\mu F$	$d \times l$ mm	100 Hz 20 °C m $\Omega$	10 kHz 20 °C m $\Omega$	100 Hz 40 °C A	100 Hz 85 °C A	
450	82	22 × 25	1 990	2 390	1,3	0,61	B43304A5826M000
	100	22 × 30	1 630	1 960	1,6	0,72	B43304A5107M000
	100	25 × 25	1 630	1 960	1,6	0,73	B43304B5107M000
	120	22 × 35	1 360	1 630	1,8	0,83	B43304A5127M000
	120	25 × 30	1 360	1 630	1,9	0,85	B43304B5127M000
	150	22 × 40	1 090	1 310	2,2	0,98	B43304A5157M000
	150	25 × 30	1 090	1 310	2,1	0,95	B43304B5157M000
	150	30 × 25	1 090	1 310	2,2	0,98	B43304C5157M000
	180	22 × 45	910	1 090	2,5	1,1	B43304A5187M000
	180	25 × 35	910	1 090	2,4	1,1	B43304B5187M000
	180	30 × 30	910	1 090	2,5	1,1	B43304C5187M000
	220	22 × 50	740	890	2,9	1,3	B43304A5227M000
	220	25 × 40	740	890	2,8	1,3	B43304B5227M000
	220	30 × 30	740	890	2,8	1,3	B43304C5227M000
	220	35 × 25	740	890	2,9	1,3	B43304D5227M000
	270	25 × 45	610	730	3,3	1,5	B43304A5277M000
	270	30 × 35	610	730	3,2	1,5	B43304B5277M000
	270	35 × 30	610	730	3,4	1,6	B43304C5277M000
	330	30 × 40	500	600	3,8	1,7	B43304A5337M000
	330	35 × 35	500	600	4,0	1,8	B43304B5337M000
	390	30 × 45	420	510	4,3	1,9	B43304A5397M000
	390	35 × 35	420	510	4,3	2,0	B43304B5397M000
	470	30 × 50	350	420	4,9	2,2	B43304A5477M000
	470	35 × 40	350	420	5,0	2,3	B43304B5477M000
	560	35 × 45	300	350	5,6	2,6	B43304A5567M000

1) 120 Hz conversion factor of ripple current:  $I_{~}(120 \text{ Hz}) = 1,03 \cdot I_{~}(100 \text{ Hz})$

2) Ordering code for standard terminals (6,3 mm).

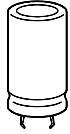
To determine the ordering code for short terminals (4,5 mm) and 3 terminals (4,5 mm) see page 226.



B43304

Miniaturized – 85 °C

**Useful life**

depending on ambient temperature  $T_A$  under ripple current operating conditions<sup>1)</sup>

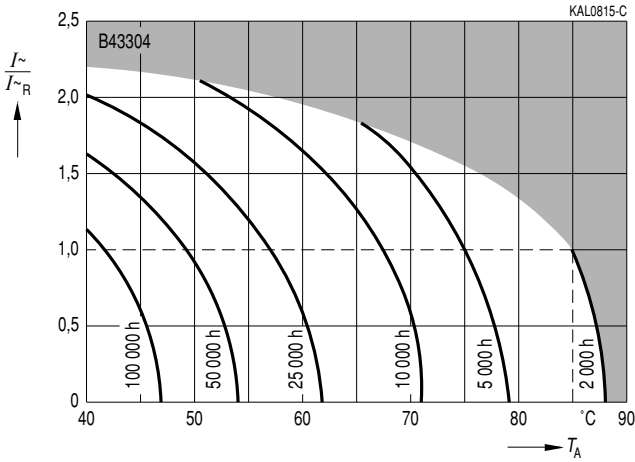

**Frequency factor of permissible ripple current  $I_{\sim}$  versus frequency  $f$**

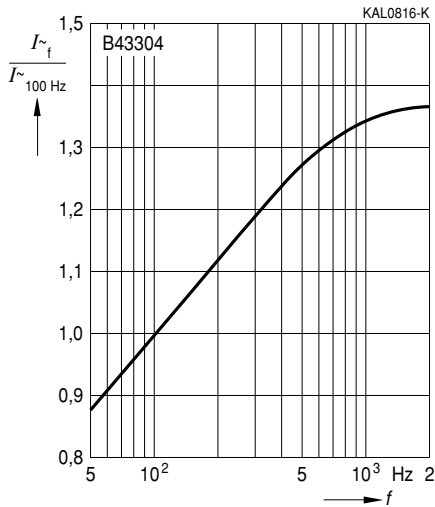

**Frequency characteristics of ESR**  
Typical behavior

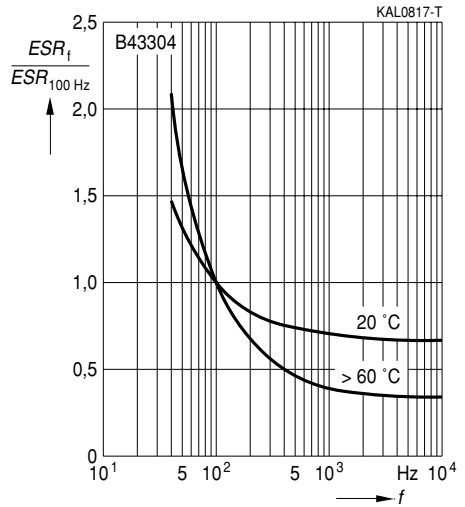

1) Refer to page 40 for an explanation on how to interpret the useful life graphs.

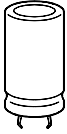

**B43304**

**Miniaturized – 85 °C**

**Impedance  $Z$**

versus frequency  $f$

Typical behavior at 20 °C

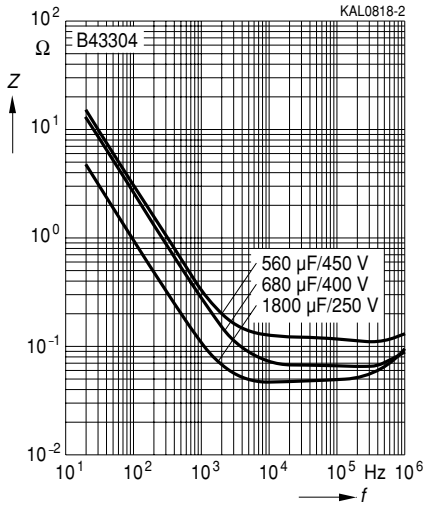

**Herausgegeben von EPCOS AG**

**Unternehmenskommunikation, Postfach 80 17 09, 81617 München, DEUTSCHLAND**

**☎ ++49 89 636 09, FAX (0 89) 636-2 26 89**

© EPCOS AG 2002. Vervielfältigung, Veröffentlichung, Verbreitung und Verwertung dieser Broschüre und ihres Inhalts ohne ausdrückliche Genehmigung der EPCOS AG nicht gestattet.

Bestellungen unterliegen den vom ZVEI empfohlenen Allgemeinen Lieferbedingungen für Erzeugnisse und Leistungen der Elektroindustrie, soweit nichts anderes vereinbart wird.

Diese Broschüre ersetzt die vorige Ausgabe.

Fragen über Technik, Preise und Liefermöglichkeiten richten Sie bitte an den Ihnen nächstgelegenen Vertrieb der EPCOS AG oder an unsere Vertriebsgesellschaften im Ausland. Bauelemente können aufgrund technischer Erfordernisse Gefahrstoffe enthalten. Auskünfte darüber bitten wir unter Angabe des betreffenden Typs ebenfalls über die zuständige Vertriebsgesellschaft einzuholen.

**Published by EPCOS AG**

**Corporate Communications, P.O. Box 80 17 09, 81617 Munich, GERMANY**

**☎ ++49 89 636 09, FAX (0 89) 636-2 26 89**

© EPCOS AG 2002. Reproduction, publication and dissemination of this brochure and the information contained therein without EPCOS' prior express consent is prohibited.

Purchase orders are subject to the General Conditions for the Supply of Products and Services of the Electrical and Electronics Industry recommended by the ZVEI (German Electrical and Electronic Manufacturers' Association), unless otherwise agreed.

This brochure replaces the previous edition.

For questions on technology, prices and delivery please contact the Sales Offices of EPCOS AG or the international Representatives.

Due to technical requirements components may contain dangerous substances. For information on the type in question please also contact one of our Sales Offices.