

$V_{DRM}$	=	2800 V
$I_{T(AV)M}$	=	5250 A
$I_{T(RMS)}$	=	8240 A
$I_{TSM}$	=	$77.0 \cdot 10^3$ A
$V_{T0}$	=	0.864 V
$r_T$	=	0.069 m $\Omega$

# Phase Control Thyristor

## 5STP 45N2800

Doc. No. 5SYA1007-06 May. 20

- Patented free-floating silicon technology
- Low on-state and switching losses
- Designed for traction, energy and industrial applications
- Optimum power handling capability
- Interdigitated amplifying gate

### Blocking

Maximum rated values <sup>1)</sup>

Parameter	Symbol	Conditions	5STP 45N2800	Unit
Max repetitive peak forward and reverse blocking voltage	$V_{DRM}$ , $V_{RRM}$	$f = 50$ Hz, $t_p = 10$ ms, $T_{vj} = 5 \dots 125$ °C, Note 1	2800	V
Critical rate of rise of commutating voltage	$dv/dt_{crit}$	Exp. to $0.67 \cdot V_{DRM}$ , $T_{vj} = 125$ °C	1000	V/ $\mu$ s

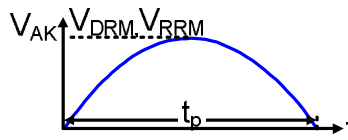

### Characteristic values

Parameter	Symbol	Conditions	min	typ	max	Unit
Forward leakage current	$I_{DRM}$	$V_{DRM}$ , $T_{vj} = 125$ °C			400	mA
Reverse leakage current	$I_{RRM}$	$V_{RRM}$ , $T_{vj} = 125$ °C			400	mA

Note 1: Voltage de-rating factor of 0.11% per °C is applicable for  $T_{vj}$  below +5 °C.

### Mechanical data

Maximum rated values <sup>1)</sup>

Parameter	Symbol	Conditions	min	typ	max	Unit
Mounting force	$F_M$		81	90	108	kN
Acceleration	$a$	Device unclamped			50	m/s <sup>2</sup>
Acceleration	$a$	Device clamped			100	m/s <sup>2</sup>

### Characteristic values

Parameter	Symbol	Conditions	min	typ	max	Unit
Weight	$m$				2.9	kg
Housing thickness	$H$	$F_M = 90$ kN, $T_a = 25$ °C	34.35		35.00	mm
Surface creepage distance	$D_s$		56			mm
Air strike distance	$D_a$		22			mm

1) Maximum rated values indicate limits beyond which damage to the device may occur

ABB Power Grids Switzerland Ltd, Semiconductors reserves the right to change specifications without notice.



## On-state

### Maximum rated values <sup>1)</sup>

Parameter	Symbol	Conditions	min	typ	max	Unit
Average on-state current	$I_{T(AV)M}$	Half sine wave, $T_c = 70\text{ °C}$			5250	A
RMS on-state current	$I_{T(RMS)}$				8240	A
Peak non-repetitive surge current	$I_{TSM}$	$t_p = 10\text{ ms}$ , $T_{vj} = 125\text{ °C}$ , sine half wave, $V_D = V_R = 0\text{ V}$ , after surge			$77.0 \cdot 10^3$	A
Limiting load integral	$I^2t$				$29.7 \cdot 10^6$	A <sup>2</sup> s
Peak non-repetitive surge current	$I_{TSM}$	$t_p = 10\text{ ms}$ , $T_{vj} = 125\text{ °C}$ , sine half wave, $V_R = 0.6 \cdot V_{RRM}$ , after surge			$60.0 \cdot 10^3$	A
Limiting load integral	$I^2t$				$18.0 \cdot 10^6$	A <sup>2</sup> s

### Characteristic values

Parameter	Symbol	Conditions	min	typ	max	Unit
On-state voltage	$V_T$	$I_T = 3000\text{ A}$ , $T_{vj} = 125\text{ °C}$		1.00	1.07	V
Threshold voltage	$V_{(T0)}$	$I_T = 3000\text{ A} - 9000\text{ A}$ , $T_{vj} = 125\text{ °C}$			0.864	V
Slope resistance	$r_T$				0.069	mΩ
Holding current	$I_H$	$T_{vj} = 25\text{ °C}$			100	mA
		$T_{vj} = 125\text{ °C}$			75	mA
Latching current	$I_L$	$T_{vj} = 25\text{ °C}$			500	mA
		$T_{vj} = 125\text{ °C}$			350	mA

## Switching

### Maximum rated values <sup>1)</sup>

Parameter	Symbol	Conditions	min	typ	max	Unit
Critical rate of rise of on-state current	$di/dt_{crit}$	$T_{vj} = 125\text{ °C}$ , $I_T = 3000\text{ A}$ , $V_D \leq 0.67 \cdot V_{DRM}$ , $I_{GM} = 2\text{ A}$ , $t_r = 0.5\text{ }\mu\text{s}$			250	A/ $\mu\text{s}$
		Cont. $f = 50\text{ Hz}$			1000	A/ $\mu\text{s}$
Circuit-commutated turn-off time	$t_q$	$T_{vj} = 125\text{ °C}$ , $I_T = 2000\text{ A}$ , $V_R = 200\text{ V}$ , $di_T/dt = -1.5\text{ A}/\mu\text{s}$ , $V_D \leq 0.67 \cdot V_{DRM}$ , $dV_D/dt = 20\text{ V}/\mu\text{s}$			400	$\mu\text{s}$

### Characteristic values

Parameter	Symbol	Conditions	min	typ	max	Unit
Reverse recovery charge	$Q_{rr}$	$T_{vj} = 125\text{ °C}$ , $I_T = 2000\text{ A}$ , $V_R = 200\text{ V}$ , $di_T/dt = -1.5\text{ A}/\mu\text{s}$	1200	3100	3800	$\mu\text{As}$
Reverse recovery current	$I_{RM}$		30	67	100	A
Gate turn-on delay time	$t_{gd}$	$T_{vj} = 25\text{ °C}$ , $V_D = 0.4 \cdot V_{RM}$ , $I_{GM} = 2\text{ A}$ , $t_r = 0.5\text{ }\mu\text{s}$			3	$\mu\text{s}$

## Triggering

Maximum rated values <sup>1)</sup>

Parameter	Symbol	Conditions	min	typ	max	Unit
Peak forward gate voltage	V <sub>FGM</sub>				12	V
Peak forward gate current	I <sub>FGM</sub>				10	A
Peak reverse gate voltage	V <sub>RGM</sub>				10	V
Average gate power loss	P <sub>G(AV)</sub>		see Fig. 7			W

Characteristic values

Parameter	Symbol	Conditions	min	typ	max	Unit
Gate-trigger voltage	V <sub>GT</sub>	T <sub>vj</sub> = 25 °C			2.6	V
Gate-trigger current	I <sub>GT</sub>	T <sub>vj</sub> = 25 °C			400	mA
Gate non-trigger voltage	V <sub>GD</sub>	V <sub>D</sub> = 0.4·V <sub>DRM</sub> , T <sub>vjmax</sub> = 125 °C			0.3	V
Gate non-trigger current	I <sub>GD</sub>	V <sub>D</sub> = 0.4·V <sub>DRM</sub> , T <sub>vjmax</sub> = 125 °C			10	mA

## Thermal

Maximum rated values <sup>1)</sup>

Parameter	Symbol	Conditions	min	typ	max	Unit
Operating junction temperature range	T <sub>vj</sub>				125	°C
Storage temperature range	T <sub>stg</sub>		-40		140	°C

Characteristic values

Parameter	Symbol	Conditions	min	typ	max	Unit
Thermal resistance junction to case	R <sub>th(j-c)</sub>	Double-side cooled F <sub>m</sub> = 81... 108 kN			5.7	K/kW
	R <sub>th(j-c)A</sub>	Anode-side cooled F <sub>m</sub> = 81... 108 kN			11.4	K/kW
	R <sub>th(j-c)C</sub>	Cathode-side cooled F <sub>m</sub> = 81... 108 kN			11.4	K/kW
Thermal resistance case to heatsink	R <sub>th(c-h)</sub>	Double-side cooled F <sub>m</sub> = 81... 108 kN			1	K/kW
	R <sub>th(c-h)</sub>	Single-side cooled F <sub>m</sub> = 81... 108 kN			2	K/kW

Analytical function for transient thermal impedance:

$$Z_{th(j-c)}(t) = \sum_{i=1}^n R_i (1 - e^{-t/\tau_i})$$

i	1	2	3	4
R <sub>i</sub> (K/kW)	3.848	1.205	0.537	0.109
τ <sub>i</sub> (s)	0.7651	0.0782	0.0048	0.0009

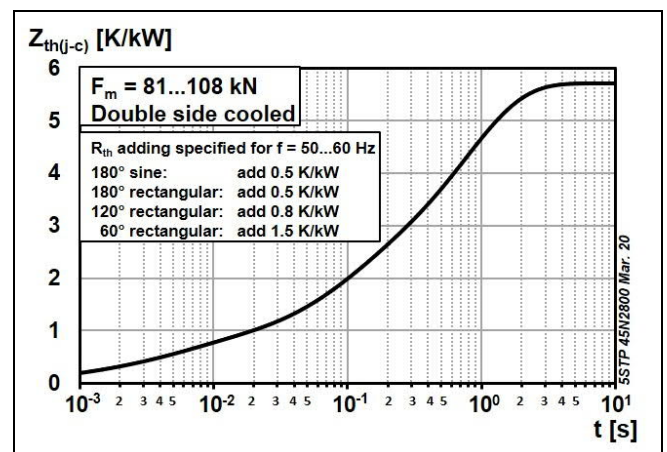

Fig. 1 Transient thermal impedance (junction-to-case) vs. time

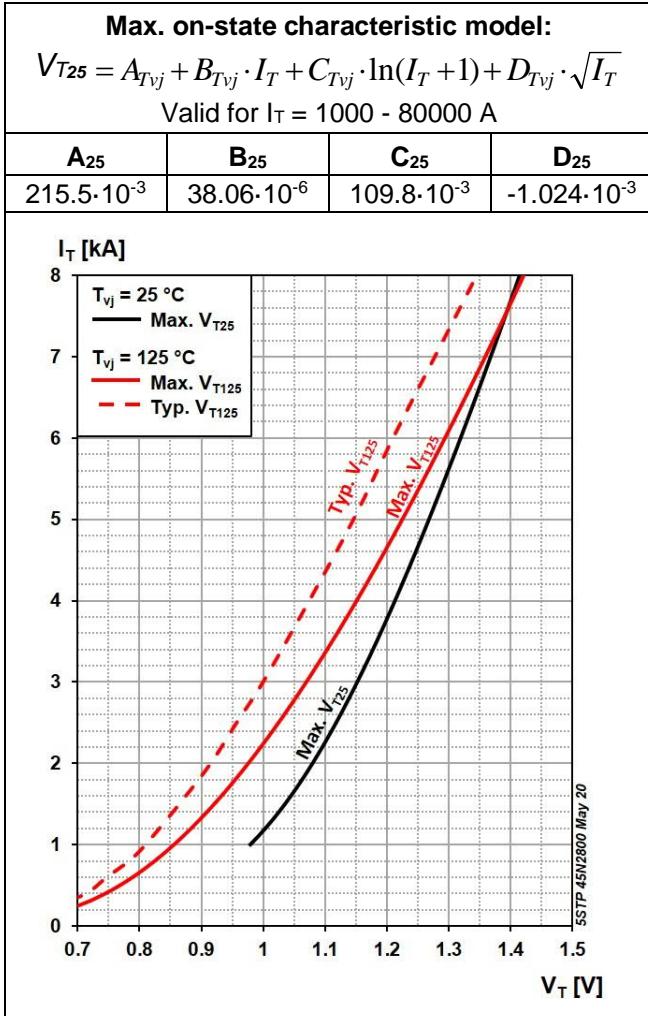

Fig. 2 On-state voltage characteristics

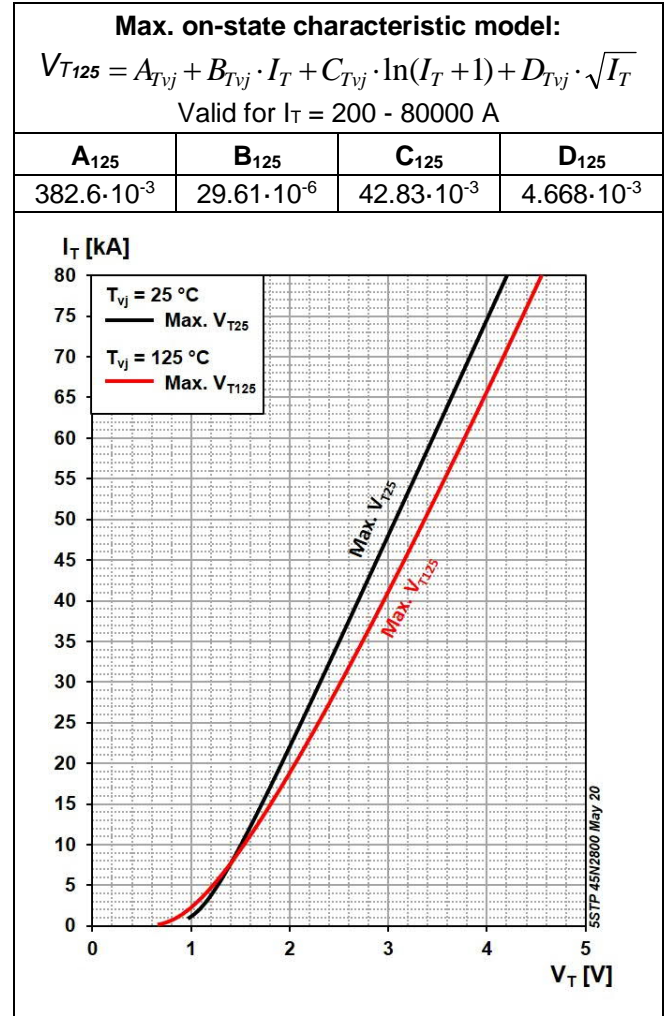

Fig. 3 On-state voltage characteristics

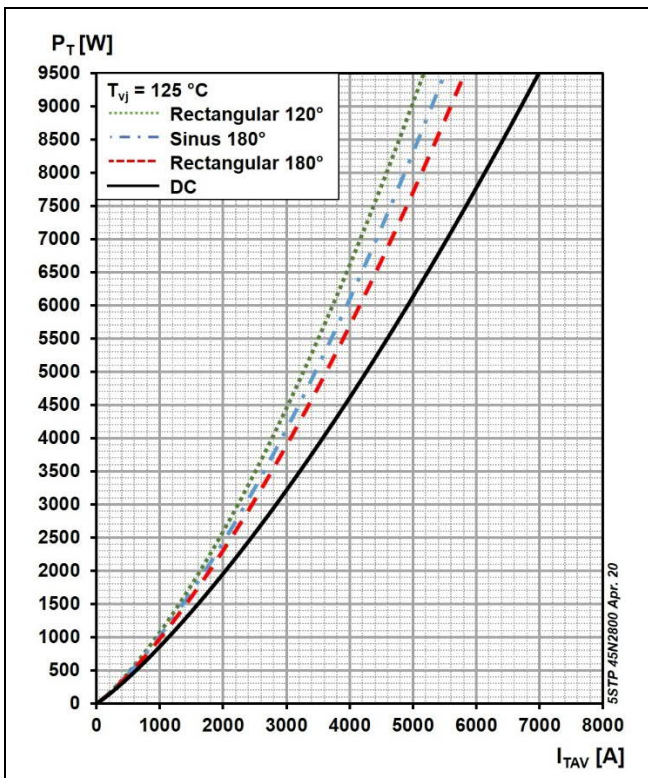

Fig. 4 On-state power dissipation vs. mean on-state current, turn-on losses excluded

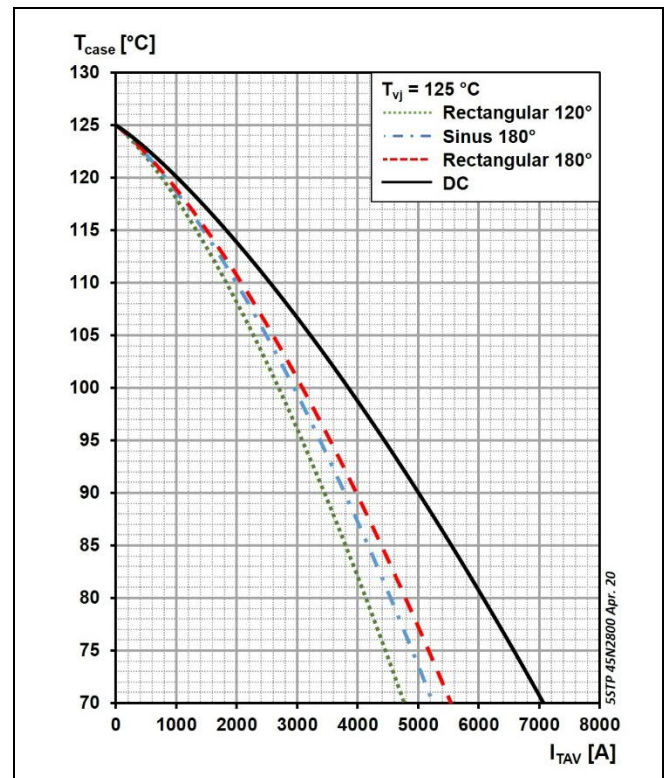

Fig. 5 Max. permissible case temperature vs. mean on-state current, switching losses ignored

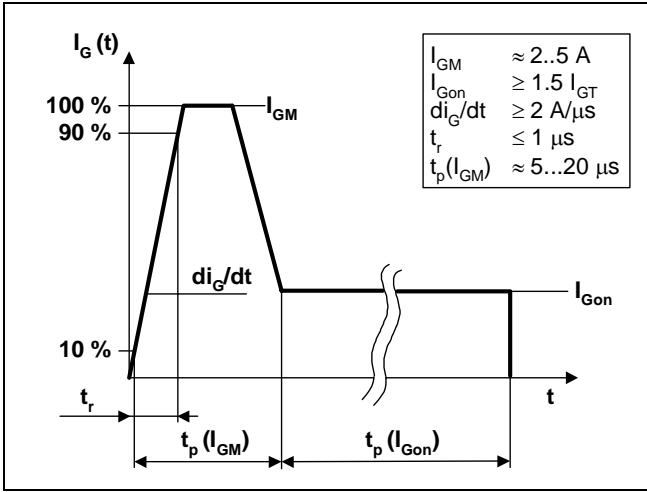

Fig. 6 Recommended gate current waveform

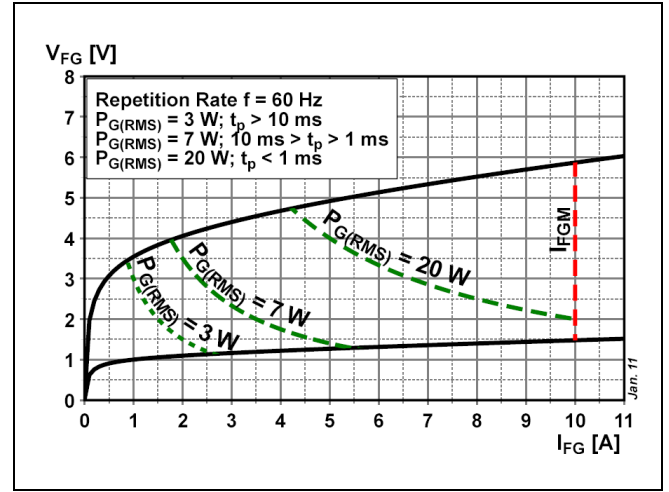

Fig. 7 Max. peak gate power loss

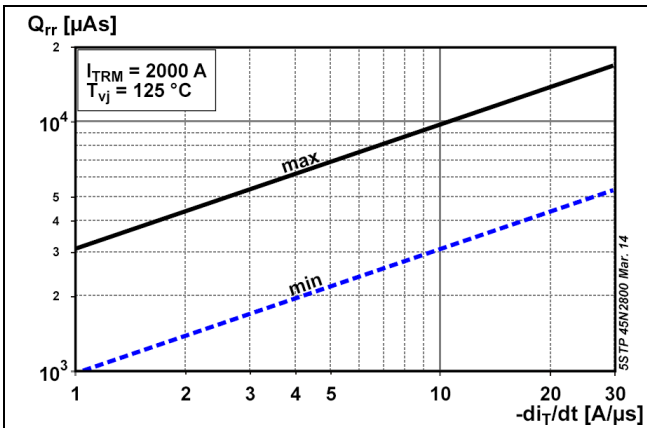

Fig. 8 Reverse recovery charge vs. decay rate of on-state current

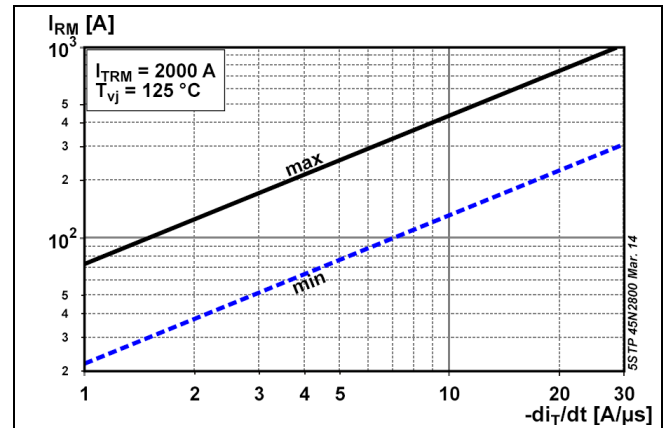

Fig. 9 Peak reverse recovery current vs. decay rate of on-state current



# Turn-on and Turn-off losses

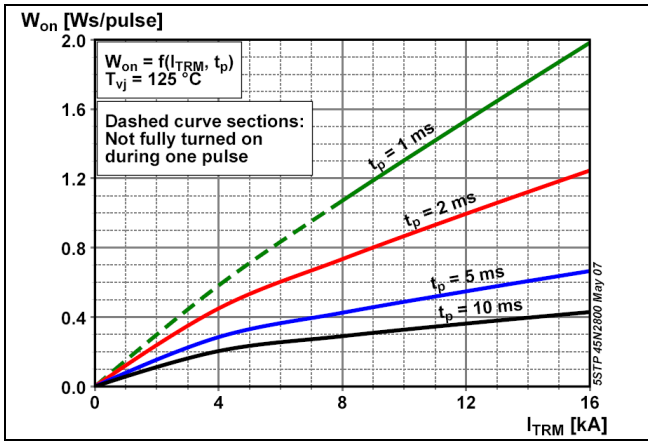

Fig. 10 Turn-on energy, half sinusoidal waves

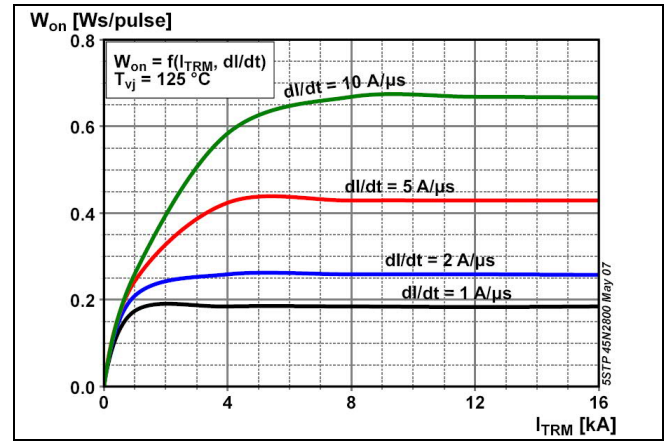

Fig. 11 Turn-on energy, rectangular waves

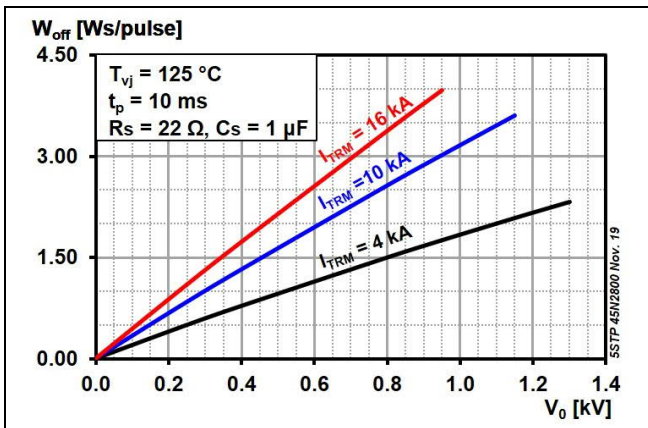

Fig. 12 Typical turn-off energy, half sinusoidal waves

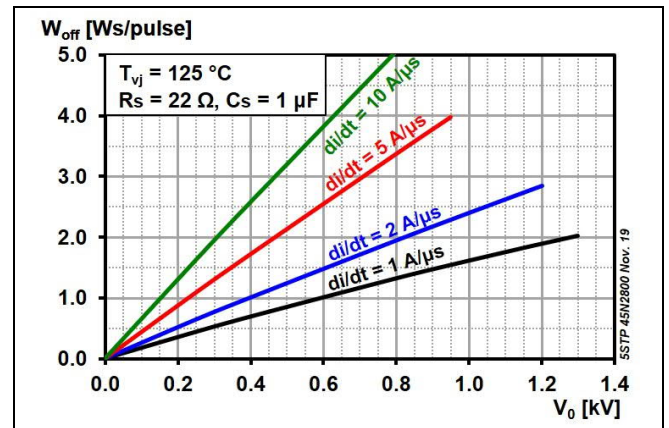

Fig. 13 Typical turn-off energy, rectangular waves

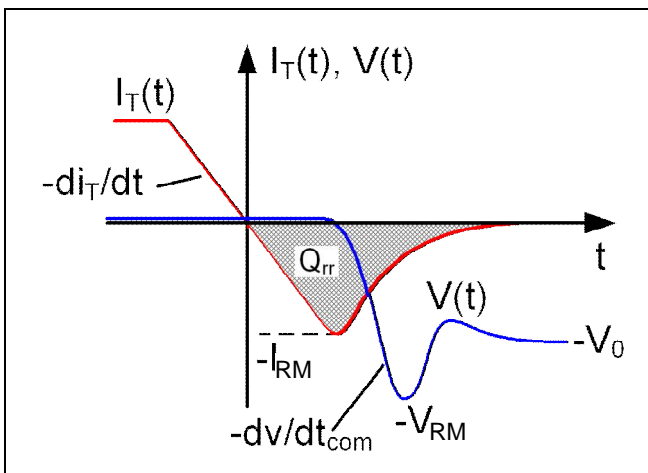

Fig. 14 Current and voltage waveforms at turn-off

**Total power loss for repetitive waveforms:**

$$P_{TOT} = P_T + W_{on} \cdot f + W_{off} \cdot f$$

where

$$P_T = \frac{1}{T} \int_0^T I_T \cdot V_T(I_T) dt$$

Fig. 15 Relationships for power loss

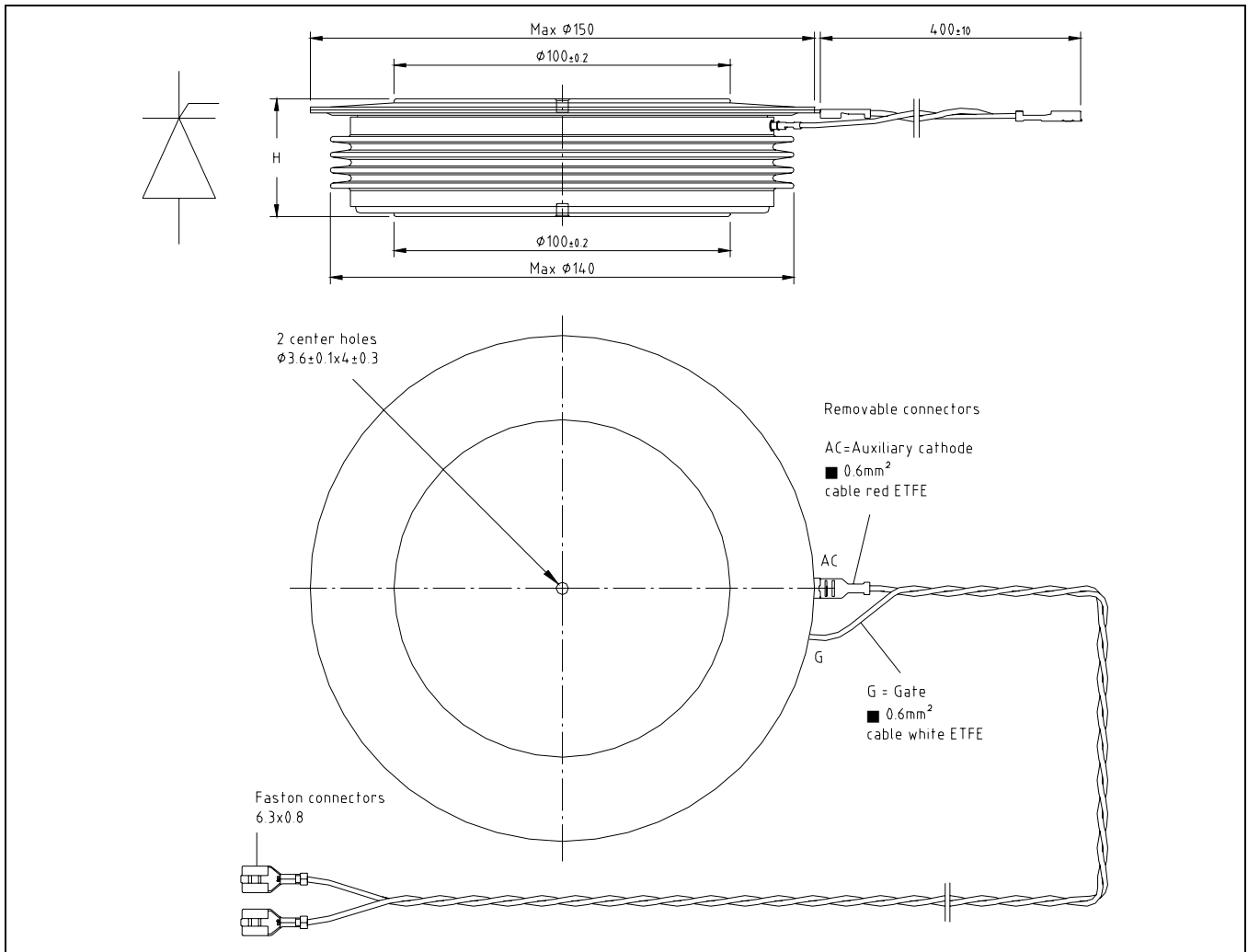

**Fig. 16** Device Outline Drawing

### Related documents:

5SYA 2020	Design of RC-Snubbers for Phase Control Applications
5SYA 2049	Voltage definitions for phase control and bi-directionally controlled thyristors
5SYA 2051	Voltage ratings of high power semiconductors
5SYA 2034	Gate-drive recommendations for phase control and bi-directionally controlled thyristors
5SYA 2036	Recommendations regarding mechanical clamping of Press-Pack High Power Semiconductors
5SYA 2102	Surge currents for Phase Control Thyristors
5SZK 9118	General Environmental Conditions for High Power Semiconductors

Please refer to <http://www.abb.com/semiconductors> for current version of documents.

**ABB Power Grids Switzerland Ltd, Semiconductors reserves the right to change specifications without notice.**



**ABB Power Grids Switzerland Ltd**  
**Semiconductors**  
 Fabrikstrasse 3  
 CH-5600 Lenzburg, Switzerland

Doc. No. 5SYA1007-06 May. 20

Telephone +41 (0)58 586 1419  
 Fax +41 (0)58 586 1306  
 Email [abbsem@ch.abb.com](mailto:abbsem@ch.abb.com)  
 Internet [www.abb.com/semiconductors](http://www.abb.com/semiconductors)