



# 5SDD 14F6000

Old part no. DV 808-1360-60

## High Voltage Diode

### Properties

- Low forward voltage drop
- Low recovery charge
- High operating temperature
- Low leakage current

### Applications

- Rectifier bridges

### Key Parameters

$V_{RRM}$	=	6 000	V
$I_{FAVm}$	=	1 363	A
$I_{FSM}$	=	17 500	A
$V_{TO}$	=	1.015	V
$r_T$	=	0.407	mΩ

### Types

	$V_{RRM}$
<b>5SDD 14F6000</b>	<b>6 000 V</b>
Conditions:	$T_j = -40 \div 150 \text{ }^\circ\text{C}$ , half sine waveform, $f = 50 \text{ Hz}$

### Mechanical Data

$F_m$	Mounting force	$22 \pm 2$	kN
$m$	Weight	0.46	kg
$D_s$	Surface creepage distance	30	mm
$D_a$	Air strike distance	20.5	mm

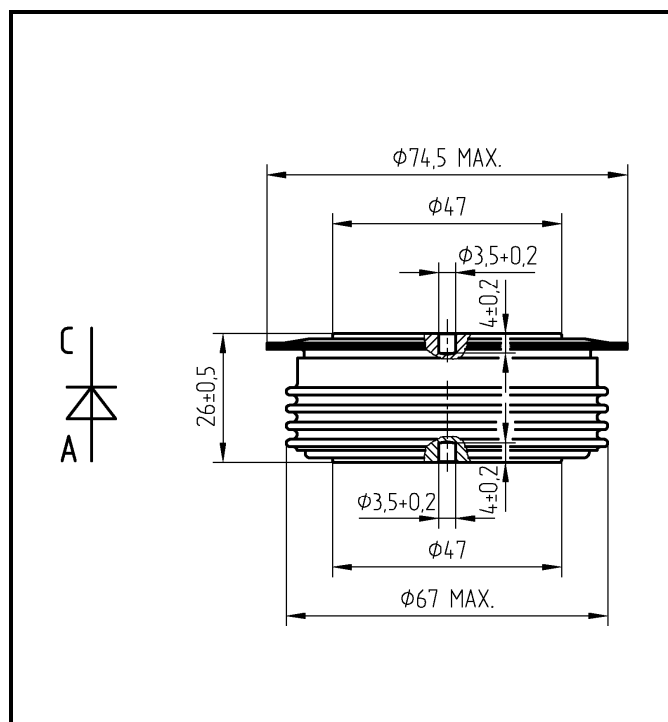

Fig. 1 Case



ABB s.r.o.

Novodvorska 1768/138a, 142 21 Praha 4, Czech Republic

tel.: +420 261 306 250, <http://www.abb.com/semiconductors>

<b>Maximum Ratings</b>		<b>Maximum Limits</b>	<b>Unit</b>	
$V_{RRM}$	<b>Repetitive peak reverse voltage</b> $T_j = -40 \div 150 \text{ }^\circ\text{C}$	<b>6 000</b>	<b>V</b>	
$I_{FAVm}$	<b>Average forward current</b> $T_c = 85 \text{ }^\circ\text{C}$	<b>1 363</b>	<b>A</b>	
$I_{FRMS}$	<b>RMS forward current</b>	<b>2 142</b>	<b>A</b>	
$I_{RRM}$	<b>Repetitive reverse current,</b> $V_R = V_{RRM}$	<b>75</b>	<b>mA</b>	
$I_{FSM}$	<b>Non repetitive peak surge current</b> $V_R = 0 \text{ V, half sine pulse, } T_j = 25 \text{ }^\circ\text{C}$	$t_p = 8.3 \text{ ms}$	<b>20 300</b>	<b>A</b>
		$t_p = 10 \text{ ms}$	<b>19 000</b>	<b>A</b>
	<b>Non repetitive peak surge current</b> $V_R = 0 \text{ V, half sine pulse}$	$t_p = 8.3 \text{ ms}$	<b>18 700</b>	<b>A</b>
		$t_p = 10 \text{ ms}$	<b>17 500</b>	<b>A</b>
$I^2t$	<b>Limiting load integral</b> $V_R = 0 \text{ V, half sine pulse, } T_j = 25 \text{ }^\circ\text{C}$	$t_p = 8.3 \text{ ms}$	<b>1 710 000</b>	<b>A<sup>2</sup>s</b>
		$t_p = 10 \text{ ms}$	<b>1 805 000</b>	<b>A<sup>2</sup>s</b>
	<b>Limiting load integral</b> $V_R = 0 \text{ V, half sine pulse}$	$t_p = 8.3 \text{ ms}$	<b>1 450 000</b>	<b>A<sup>2</sup>s</b>
		$t_p = 10 \text{ ms}$	<b>1 531 250</b>	<b>A<sup>2</sup>s</b>
$T_{jmin} - T_{jmax}$	<b>Operating temperature range</b>	<b>-40 <math>\div</math> 150</b>	<b><math>^\circ\text{C}</math></b>	
$T_{STG}$	<b>Storage temperature range</b>	<b>-40 <math>\div</math> 150</b>	<b><math>^\circ\text{C}</math></b>	

Unless otherwise specified  $T_j = 150 \text{ }^\circ\text{C}$

<b>Characteristics</b>		<b>Value</b>			<b>Unit</b>
		<b>min</b>	<b>typ</b>	<b>max</b>	
$V_{T0}$	<b>Threshold voltage</b> $I_{F1} = 2\,142 \text{ A, } I_{F2} = 6\,425 \text{ A}$			<b>1.015</b>	<b>V</b>
$r_T$	<b>Forward slope resistance</b>			<b>0.407</b>	<b>m<math>\Omega</math></b>
$V_{FM}$	<b>Maximum forward voltage</b> $I_{FM} = 4\,000 \text{ A}$			<b>2.68</b>	<b>V</b>
$Q_{rr}$	<b>Recovered charge</b> $V_R = 100 \text{ V, } I_{FM} = 1\,000 \text{ A, } di_F/dt = -10 \text{ A}/\mu\text{s}$		<b>3 000</b>	<b>4 000</b>	<b><math>\mu\text{C}</math></b>

Unless otherwise specified  $T_j = 150 \text{ }^\circ\text{C}$

Thermal Parameters			Value	Unit
$R_{thjc}$	Thermal resistance junction to case	double side cooling	20	K/kW
		anode side cooling	34	
		cathode side cooling	48	
$R_{thch}$	Thermal resistance case to heatsink	double side cooling	5	K/kW
		single side cooling	10	

**Transient Thermal Impedance**

Analytical function for transient thermal impedance

$$Z_{thjc} = \sum_{i=1}^4 R_i (1 - \exp(-t / \tau_i))$$

Conditions:  
 $F_m = 22 \pm 2$  kN, Double side cooled

$i$	1	2	3	4
$R_i$ (K/kW)	11.83	4.26	1.63	2.28
$\tau_i$ (s)	0.432	0.071	0.01	0.0054

Fig. 2 Dependence transient thermal impedance junction to case on square pulse

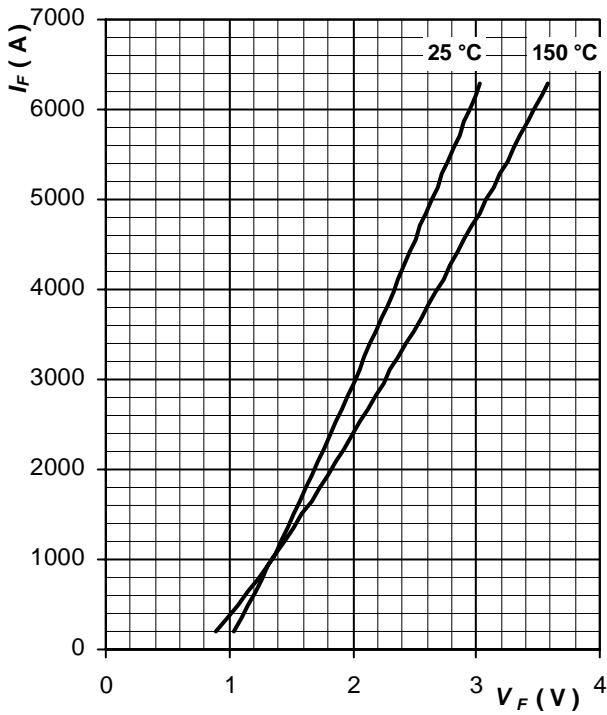

Fig. 3 Maximum forward voltage drop characteristics

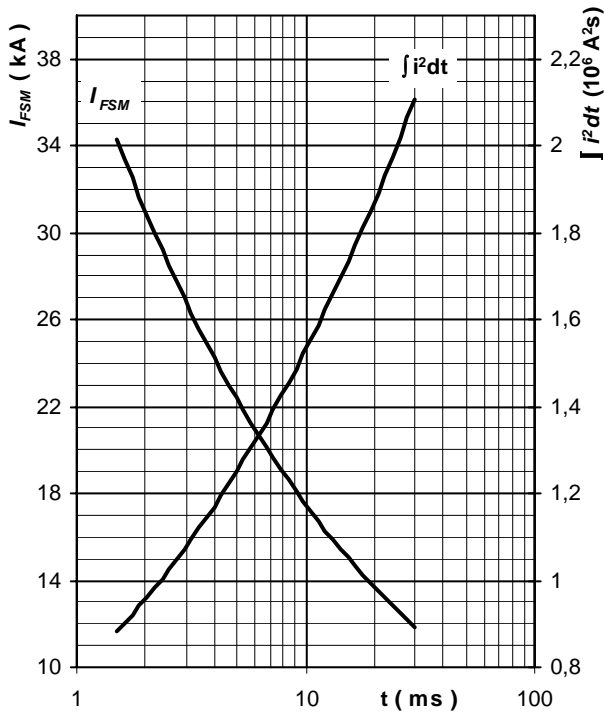

Fig. 4 Surge forward current vs. pulse length, half sine wave, single pulse,  $V_R = 0 V, T_j = T_{jmax}$

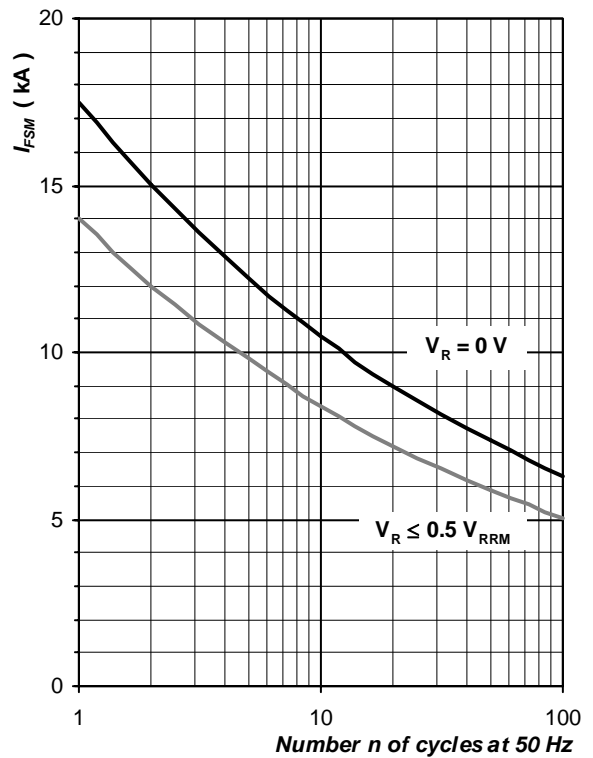

Fig. 5 Surge forward current vs. number of pulses, half sine wave,  $T_j = T_{jmax}$

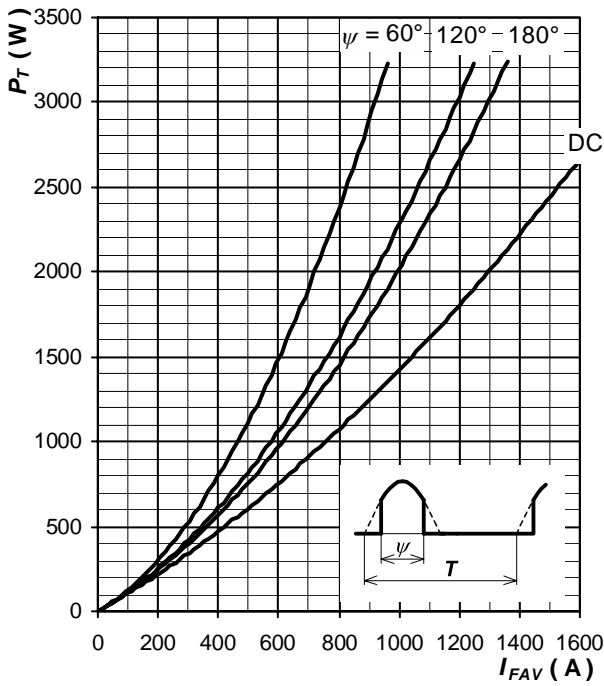

Fig. 6 Forward power loss vs. average forward current, sine waveform,  $f = 50 \text{ Hz}$ ,  $T = 1/f$

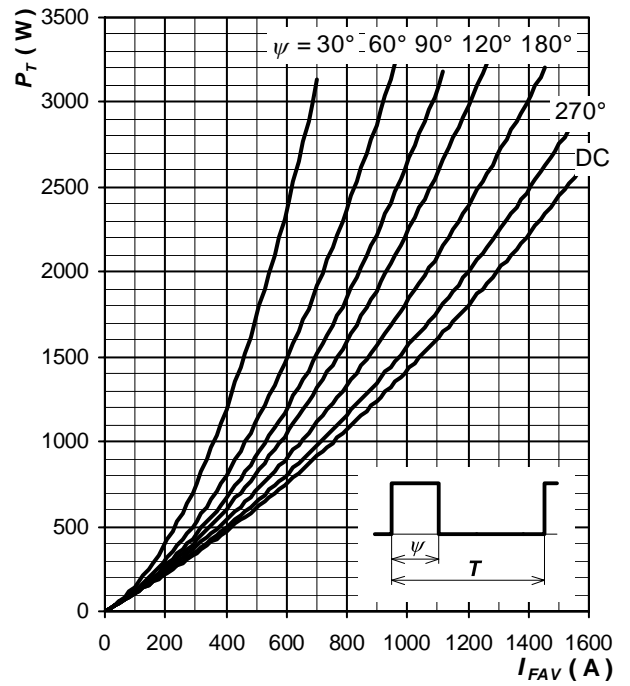

Fig. 7 Forward power loss vs. average forward current, square waveform,  $f = 50 \text{ Hz}$ ,  $T = 1/f$

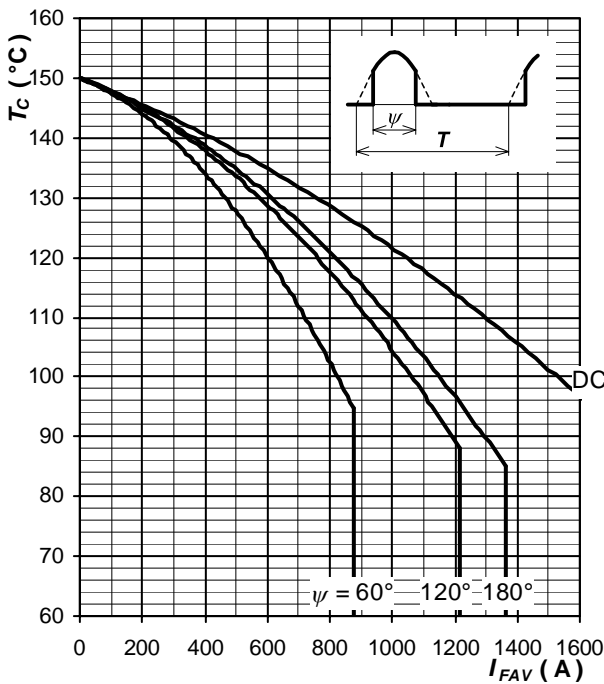

Fig. 8 Max. case temperature vs. aver. forward current, sine waveform,  $f = 50 \text{ Hz}$ ,  $T = 1/f$

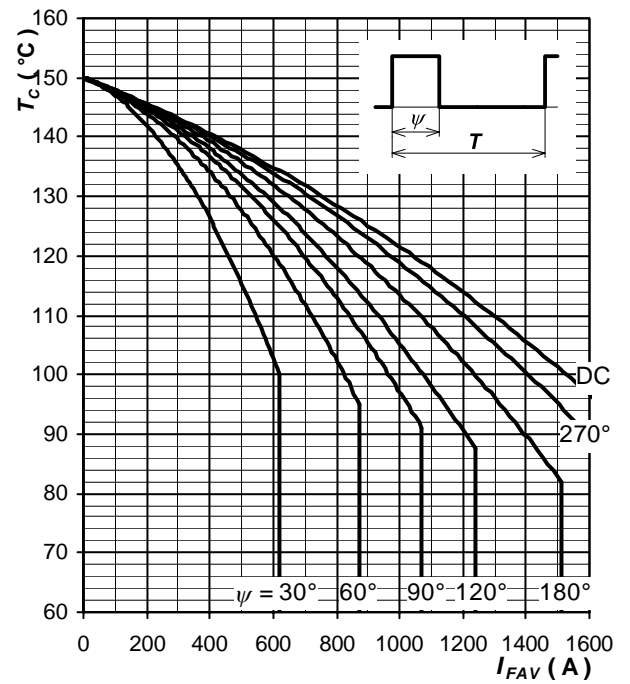

Fig. 9 Max. case temperature vs. aver. forward current, square waveform,  $f = 50 \text{ Hz}$ ,  $T = 1/f$

Notes: