

# CDD36

## Diode-Diode Modules

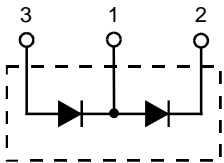
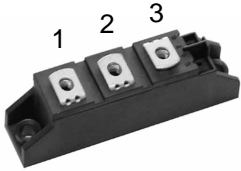

Type	$V_{RSM}$ V	$V_{RRM}$ V
CDD36N08	900	800
CDD36N12	1300	1200
CDD36N14	1500	1400
CDD36N16	1700	1600
CDD36N18	1900	1800

Dimensions in mm (1mm=0.0394")

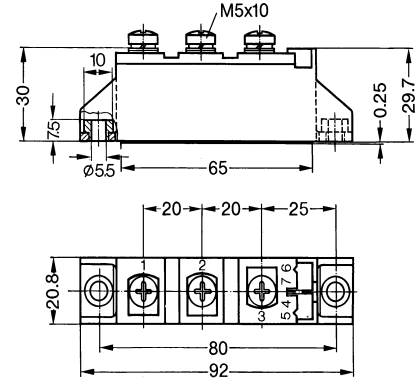

Symbol	Test Conditions	Maximum Ratings	Unit
$I_{FRMS}$ $I_{FAVM}$	$T_{VJ}=T_{VJM}$ $T_C=100^{\circ}C$ ; 180° sine	60 36	A
$I_{FSM}$	$T_{VJ}=45^{\circ}C$ $V_R=0$ t=10ms (50Hz), sine t=8.3ms (60Hz), sine	650 760	A
	$T_{VJ}=T_{VJM}$ $V_R=0$ t=10ms(50Hz), sine t=8.3ms(60Hz), sine	580 630	
$\int i^2 dt$	$T_{VJ}=45^{\circ}C$ $V_R=0$ t=10ms (50Hz), sine t=8.3ms (60Hz), sine	2100 2400	$A^2s$
	$T_{VJ}=T_{VJM}$ $V_R=0$ t=10ms(50Hz), sine t=8.3ms(60Hz), sine	1700 1900	
$T_{VJ}$ $T_{VJM}$ $T_{stg}$		-40...+150 150 -40...+125	$^{\circ}C$
$V_{ISOL}$	50/60Hz, RMS $I_{ISOL} \leq 1mA$ t=1min t=1s	3000 3600	V~
$M_d$	Mounting torque (M5) Terminal connection torque (M5)	2.5-4/22-35 2.5-4/22-35	Nm/lb.in.
Weight	Typical including screws	90	g

# CDD36

## Diode-Diode Modules

Symbol	Test Conditions	Characteristic Values	Unit
<b>I<sub>R</sub></b>	$T_{VJ}=T_{VJM}; V_R=V_{RRM}$	10	mA
<b>V<sub>F</sub></b>	$I_F=80A; T_{VJ}=25^{\circ}C$	1.38	V
<b>V<sub>TO</sub></b>	For power-loss calculations only	0.8	V
<b>r<sub>T</sub></b>	$T_{VJ}=T_{VJM}$	6.1	m $\Omega$
<b>Q<sub>S</sub></b>	$T_{VJ}=125^{\circ}C; I_F=25A; -di/dt=0.6A/us$	50	$\mu C$
<b>I<sub>RM</sub></b>		6	A
<b>R<sub>thJC</sub></b>	per diode; DC current per module	1.0 0.5	K/W
<b>R<sub>thJK</sub></b>	per diode; DC current per module	1.2 0.6	K/W
<b>ds</b>	Creepage distance on surface	12.7	mm
<b>dA</b>	Strike distance through air	9.6	mm
<b>a</b>	Maximum allowable acceleration	50	m/s <sup>2</sup>

### FEATURES

- \* International standard package
- \* Direct copper bonded Al<sub>2</sub>O<sub>3</sub>-ceramic base plate
- \* Planar passivated chips
- \* Isolation voltage 3600 V~
- \* UL registered, E 72873

### APPLICATIONS

- \* Supplies for DC power equipment
- \* DC supply for PWM inverter
- \* Field supply for DC motors
- \* Battery DC power supplies

### ADVANTAGES

- \* Space and weight savings
- \* Simple mounting
- \* Improved temperature and power cycling
- \* Reduced protection circuits

# CDD36

## Diode-Diode Modules

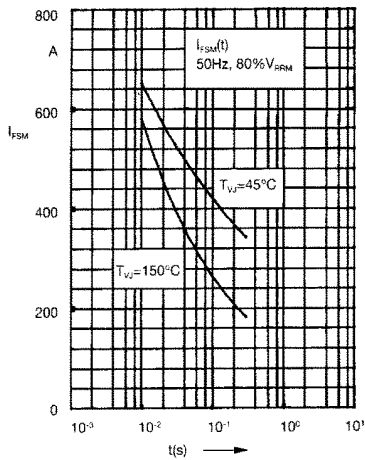

Fig. 1 Surge overload current  
 $I_{FSM}$ : Crest value, t: duration

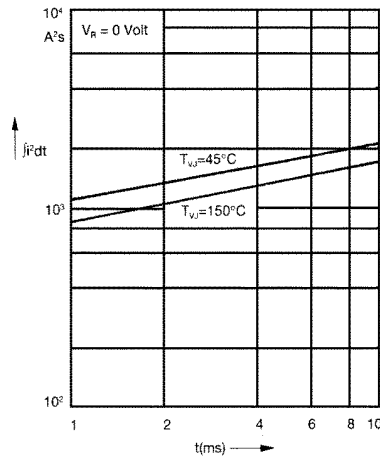

Fig. 2  $\int i^2 dt$  versus time (1-10 ms)

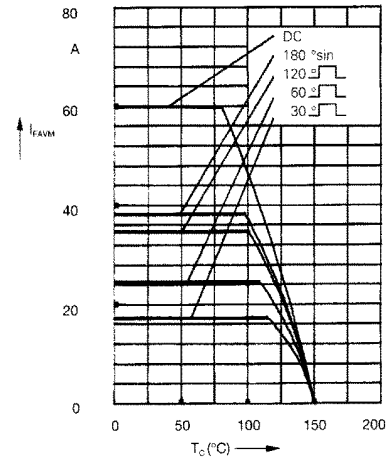

Fig. 2a Maximum forward current at case temperature

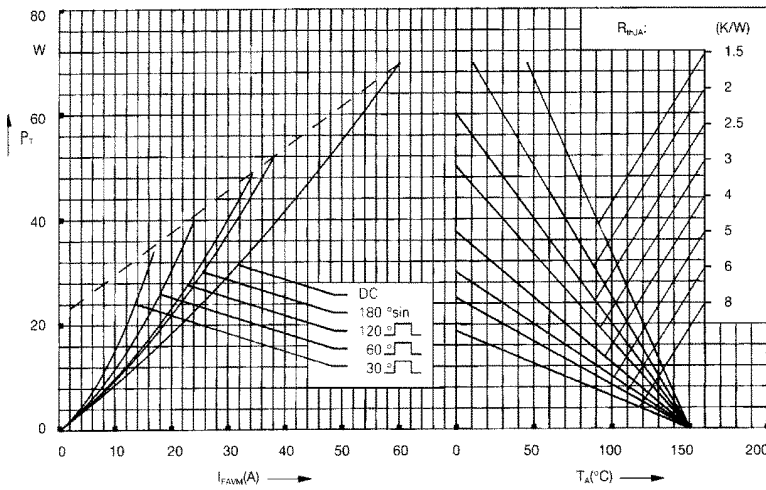

Fig. 3 Power dissipation versus forward current and ambient temperature (per diode)

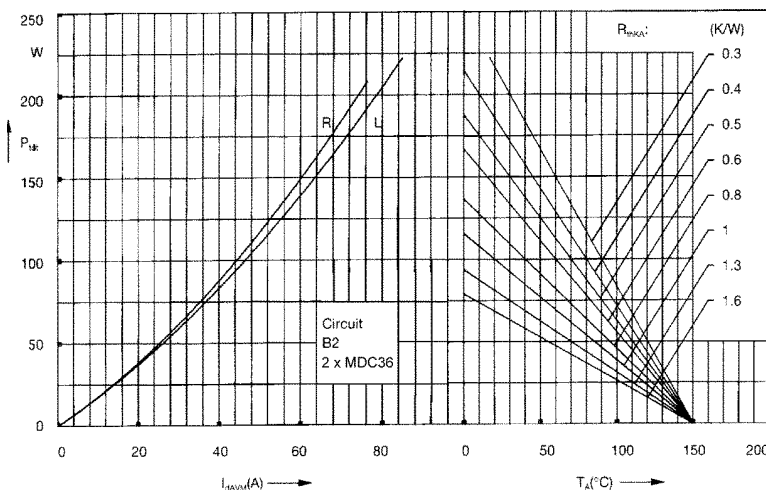

Fig. 4 Single phase rectifier bridge:  
 Power dissipation versus direct output current and ambient temperature  
 R = resistive load  
 L = inductive load

# CDD36

## Diode-Diode Modules

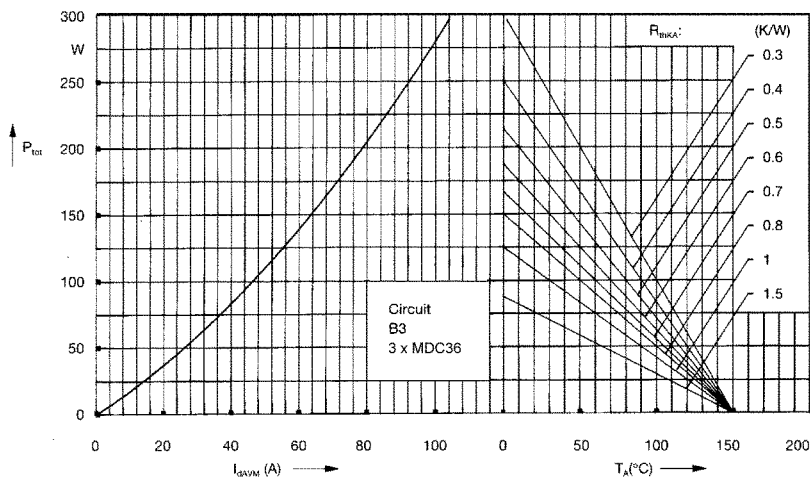

Fig. 5 Three phase rectifier bridge: Power dissipation versus direct output current and ambient temperature

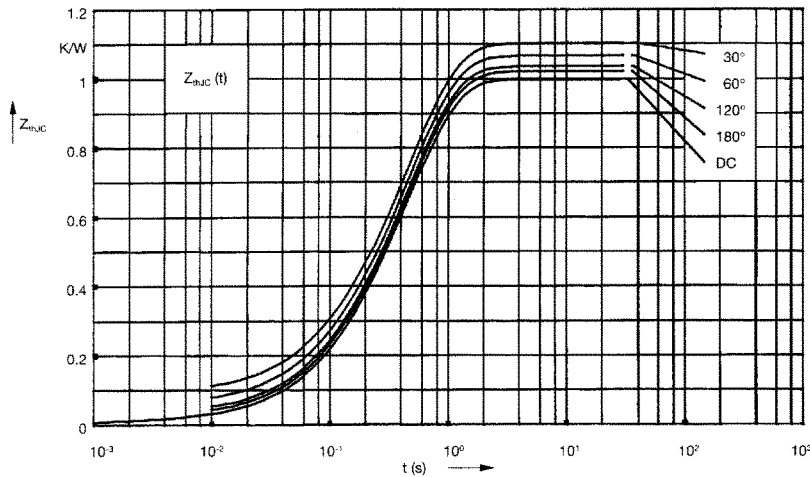

Fig. 6 Transient thermal impedance junction to case (per diode)

$R_{thJC}$  for various conduction angles  $d$ :

$d$	$R_{thJC}$ (K/W)
DC	1.00
180°C	1.02
120°C	1.04
60°C	1.07
30°C	1.10

Constants for  $Z_{thJC}$  calculation:

$i$	$R_{thi}$ (K/W)	$t_i$ (s)
1	0.01	0.0012
2	0.03	0.095
3	0.96	0.455

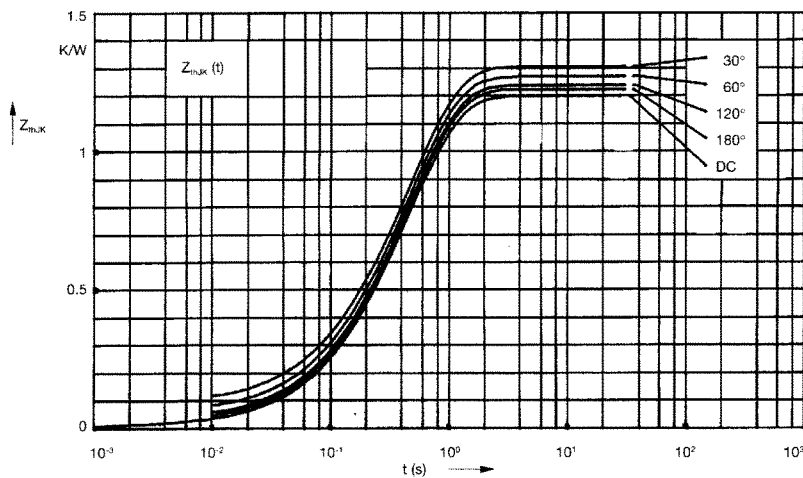

Fig. 7 Transient thermal impedance junction to heatsink (per diode)

$R_{thJK}$  for various conduction angles  $d$ :

$d$	$R_{thJK}$ (K/W)
DC	1.20
180°C	1.22
120°C	1.24
60°C	1.27
30°C	1.30

Constants for  $Z_{thJK}$  calculation:

$i$	$R_{thi}$ (K/W)	$t_i$ (s)
1	0.01	0.0012
2	0.03	0.095
3	0.96	0.455
4	0.2	0.495